



## PolyZen Devices

### Polymer Protected Zener Diode

PolyZen devices are polymer enhanced precision Zener diode micro-assemblies that help protect sensitive electronics from damage caused by inductive voltage spikes, voltage transients, use of incorrect power supplies and reverse bias.

The PolyZen micro-assembly incorporates a stable Zener diode for precise voltage clamping and a resistively non-linear, polymeric positive temperature coefficient (PPTC) layer that responds to either diode heating or overcurrent events by transitioning from a low to high resistance state.

PolyZen devices help provide resettable protection against damage caused by multi-watt fault events and require only 0.7W power dissipation. In the event of sustained high power conditions, the PPTC element of the device “trips” to limit current and generate voltage drop. This functionality helps protect both the Zener and the follow-on electronics, effectively increasing the diode’s power handling capacity.



#### Benefits

- Helps shield downstream electronics from overvoltage and reverse bias
- Trip events shut out overvoltage and reverse bias sources
- Analog nature of trip events minimize upstream inductive spikes
- Helps reduce design costs with single component placement and minimal heat sinking requirements

#### Applications

- Portable media players
- Global positioning systems
- Hard disk drives 5V & 12V bus
- Solid State Drives (SSD) 5V bus

#### Features

- RoHS compliant
- Overvoltage transient suppression
- Hold currents up to 2.3A
- Time delayed, overvoltage trip
- Time delayed, reverse bias trip
- Power handling on the order of 30 watts
- Integrated device construction

- Cellphone charger port and USB power
- Automotive peripheral input power
- DC power port protection
- Industrial handheld POS

**Figure PZ1 Typical Application Block Diagram for PolyZen Devices**

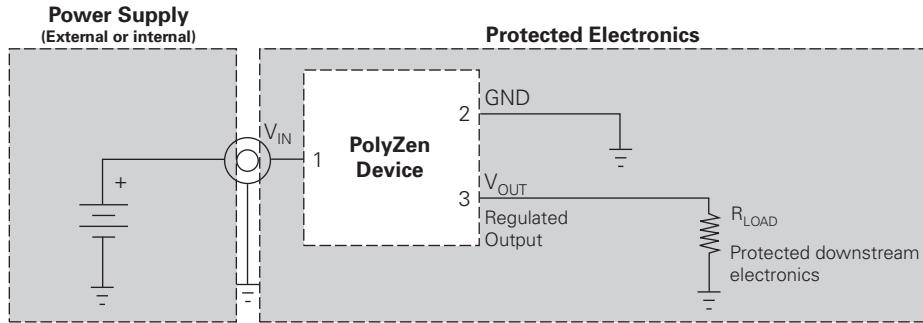

**Table PZ1 Electrical Characteristics for PolyZen Devices**

(Performance ratings @ 25°C unless otherwise specified)

Part Number	$V_Z$ (V)			$I_{Zt}$ (A)	$I_{HOLD}$ @ 20°C (A)	$R_{Typ}$ ( $\Omega$ )	$R_{1MAX}$ ( $\Omega$ )	$V_{INT MAX}$		$I_{FLT MAX}$	
	Min.	Typ.	Max.					$V_{INT MAX}$ (V)	Test Current (A)	$I_{FLT MAX}$ (A)	Test Voltage (V)
ZEN056V130A24LS	5.45	5.60	5.75	0.10	1.30	0.12	0.16	24V	3A	+10/-40	+24/-16V
ZEN059V130A24LS†	5.80	5.90	6.00	0.10	1.30	0.12	0.15	24V	3A	+6/-40	+24/-16V
ZEN065V130A24LS	6.35	6.50	6.65	0.10	1.30	0.12	0.16	24V	3A	+6/-40	+24/-16V
ZEN098V130A24LS	9.60	9.80	10.00	0.10	1.30	0.12	0.16	24V	3A	+3.5/-40	+24/-16V
ZEN132V130A24LS	13.20	13.40	13.60	0.10	1.30	0.12	0.16	24V	3A	+2/-40	+24/-16V
ZEN164V130A24LS	16.10	16.40	16.60	0.10	1.30	0.12	0.16	24V	3A	+1.25/-40	+24/-16V
ZEN056V230A16LS	5.45	5.60	5.75	0.10	2.30	0.04	0.06	16V	5A	+5/-40	+16/-12V
ZEN065V230A16LS	6.35	6.50	6.65	0.10	2.30	0.04	0.06	16V	5A	+3.5/-40	+16/-12V
ZEN098V230A16LS	9.60	9.80	10.00	0.10	2.30	0.04	0.06	16V	5A	+3.5/-40	+16/-12V
ZEN132V230A16LS	13.20	13.40	13.60	0.10	2.30	0.04	0.06	16V	5A	+2/-40	+20/-12V
ZEN056V075A48LS	5.45	5.60	5.75	0.10	0.75	0.28	0.45	48V	3A	+10/-40	+48/-16V
ZEN132V075A48LS	13.20	13.40	13.60	0.10	0.75	0.28	0.45	48V	3A	+2/-40	+48/-16V
ZEN056V115A24LS	5.45	5.60	5.75	0.10	1.15	0.15	0.18	24V	3A	+10/-40	+24/-16V
ZEN056V130A24GS*	5.45	5.60	5.75	0.10	1.30	0.12	0.18	24V	3A	+6/-40	+24/-16V

\* Module height is 1.25mm. Module height of all other part numbers is 2.0mm.

† Typical operating current is 500 $\mu$ A @ 5.0V which meets USB suspend mode requirement.

**Table PZ2 Definitions of Terms for PolyZen Devices**

$V_Z$	Zener clamping voltage measured at current $I_{Zt}$ and 20°C.
$I_{Zt}$	Test current at which $V_Z$ is measured.
$I_{HOLD}$	Maximum steady state current $I_{PTC}$ that will not generate a trip event at the specified temperature. Ratings assume $I_{FLT} = 0A$ .
$R_{Typ}$	Typical resistance between $V_{IN}$ and $V_{OUT}$ pins when the device is at room temperature.
$R_{1MAX}$	The maximum resistance between $V_{IN}$ and $V_{OUT}$ pins, at room temperature, one hour after first trip or after reflow soldering.
$I_{FLT}$	Current flowing through the Zener diode.
$I_{FLT MAX}$	Maximum RMS fault current the Zener diode component of the device can withstand and remain resettable; testing is conducted at rated voltage with no load connected to $V_{OUT}$ .
$V_{INT MAX}$	The voltage ( $V_{IN} - V_{OUT}$ "post trip") at which typical qualification devices (98% devices, 95% confidence) survived at least 100 trip cycles and 24 hours trip endurance when "tripped" at the specified voltage and current ( $I_{PTC}$ ).
$I_{PTC}$	Current flowing through the PTC portion of the circuit.
$I_{OUT}$	Current flowing out the $V_{OUT}$ pin of the device.
Trip Event	A condition where the PTC transitions to a high resistance state, thereby limiting $I_{PTC}$ , and significantly increasing the voltage drop between $V_{IN}$ and $V_{OUT}$ .

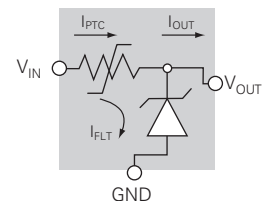
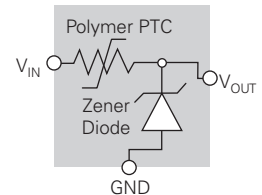

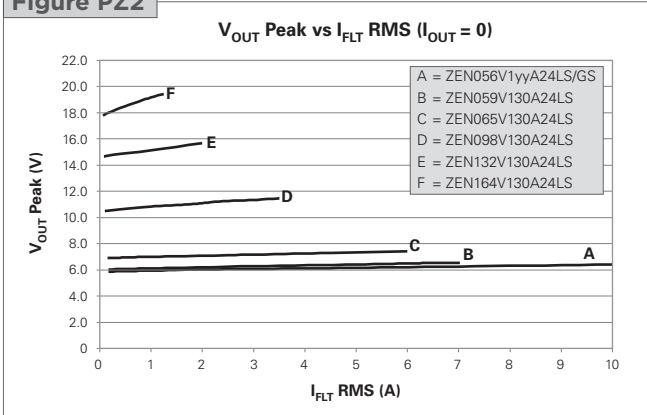
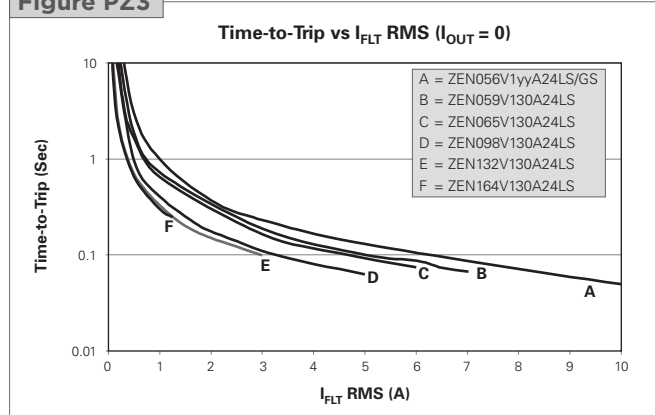
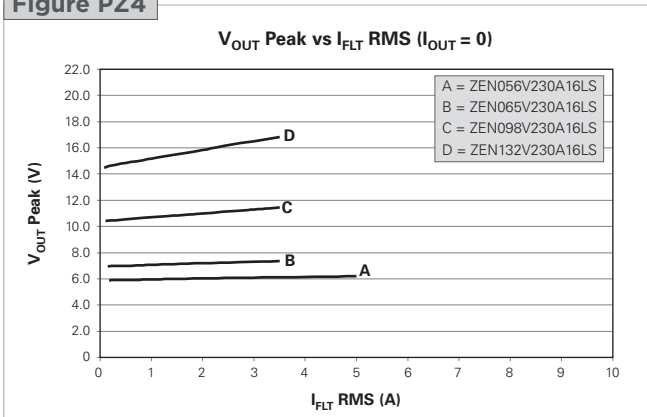
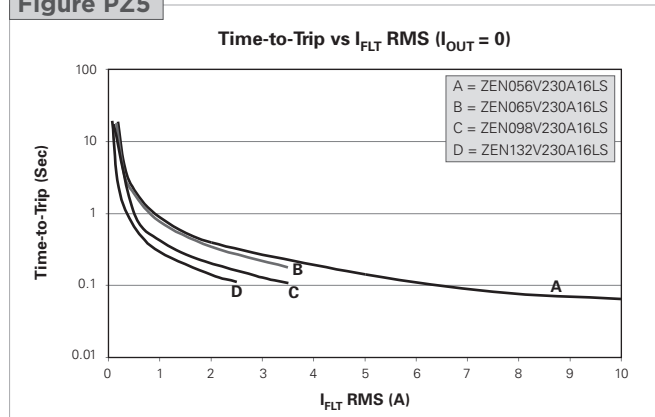
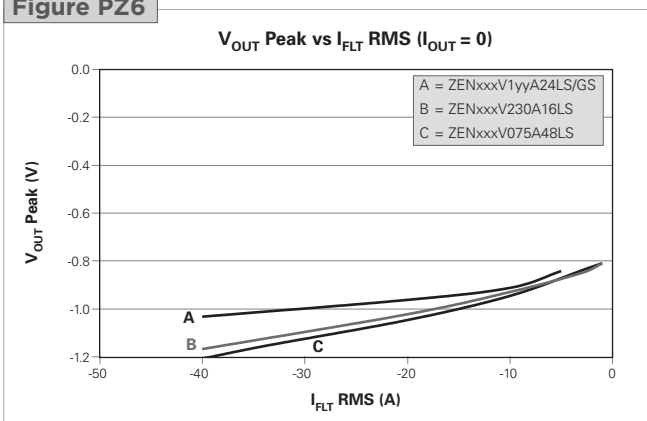
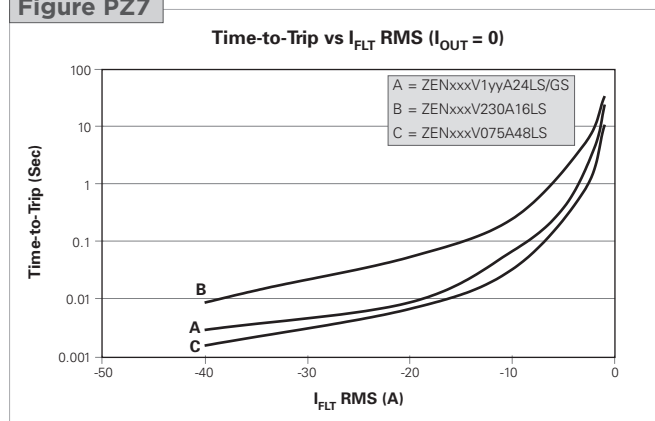
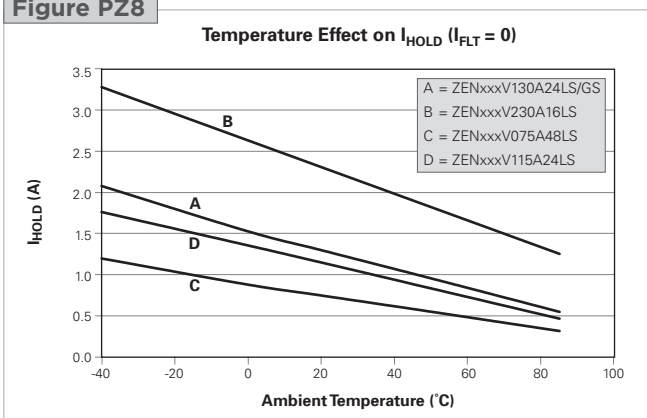
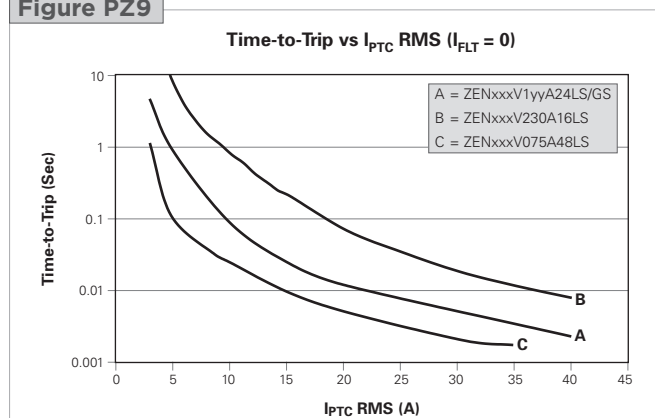
**Figure PZ2-PZ9 Typical Performance Curves for PolyZen Devices**
**Figure PZ2**

**Figure PZ3**

**Figure PZ4**

**Figure PZ5**

**Figure PZ6**

**Figure PZ7**

**Figure PZ8**

**Figure PZ9**

## Table PZ3 General Characteristics for PolyZen Devices

Operating temperature range	-40° to +85°C	
Storage temperature	-40° to +85°C	
ESD withstand	15kV	Human body model
Diode capacitance	4200pF	Typical @ 1MHz, 1V RMS
Construction	RoHS compliant	

## Figure PZ10-PZ23 Basic Operation Examples for PolyZen Devices

Figure PZ10

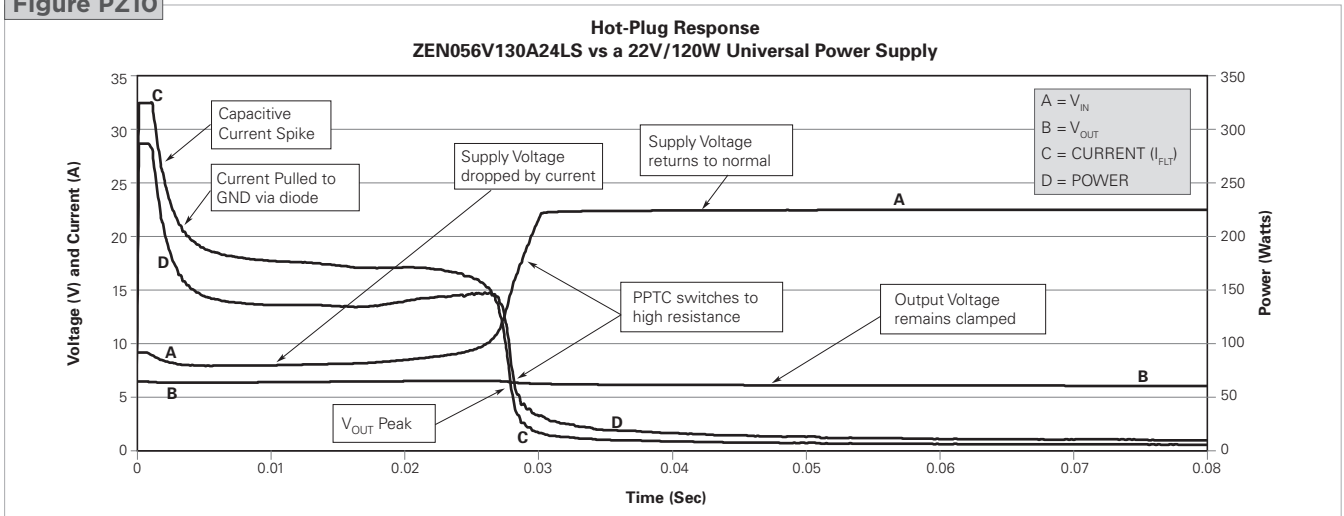

Figure PZ11

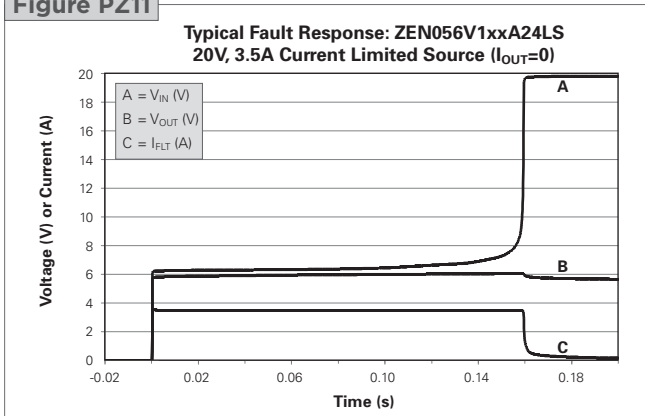

Figure PZ12

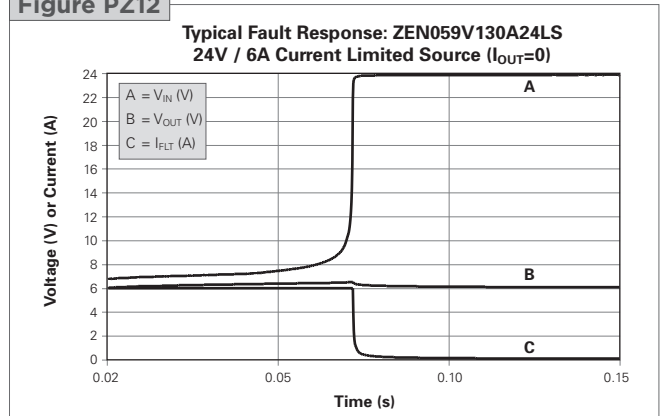

Figure PZ13

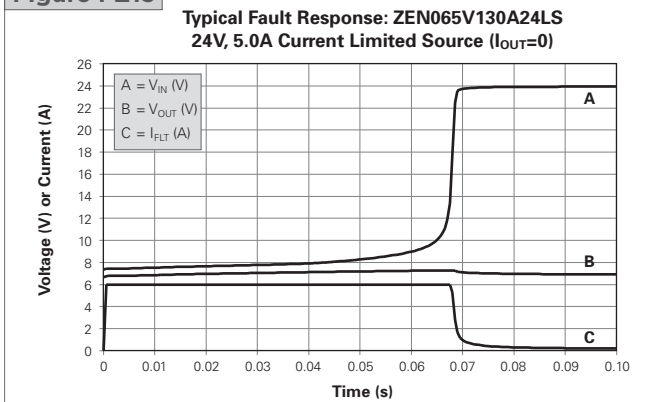
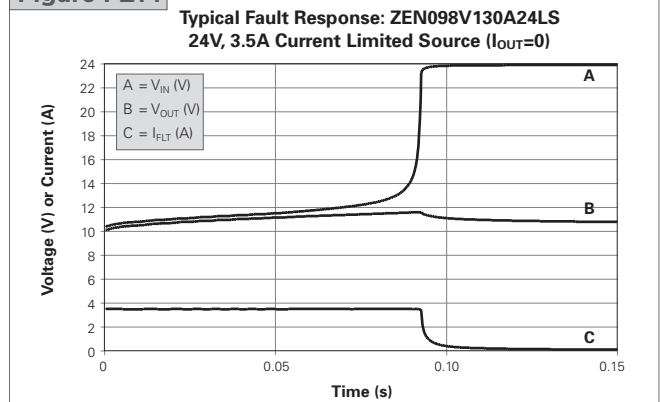
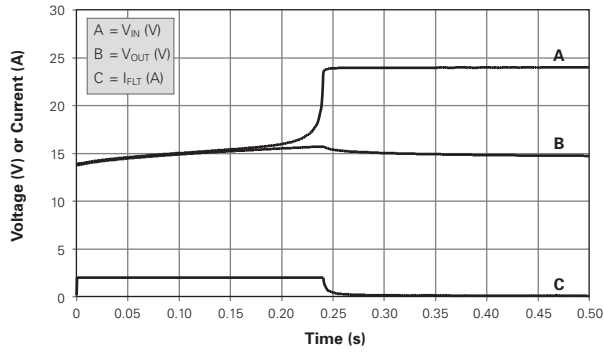
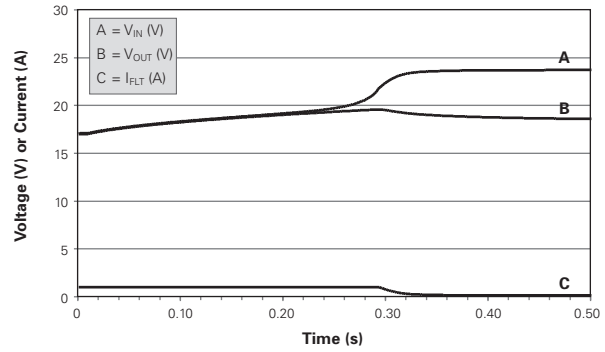
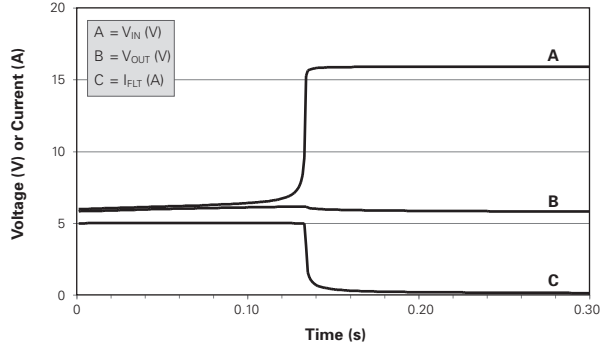
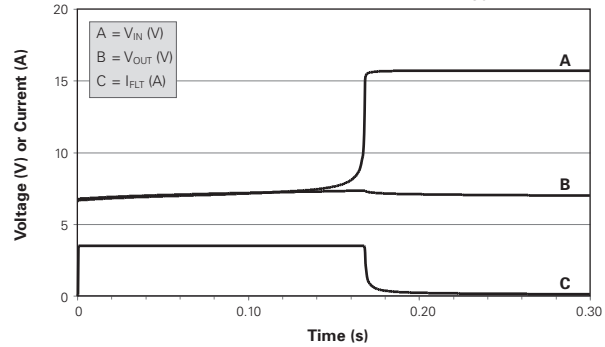
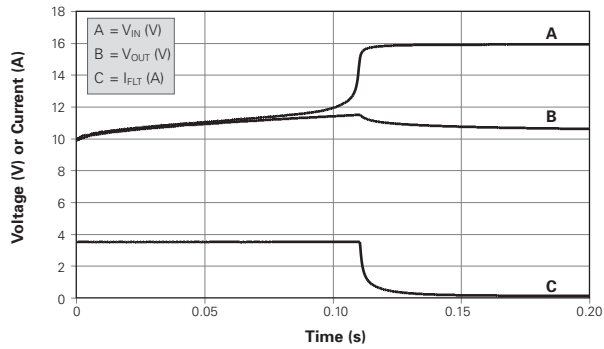
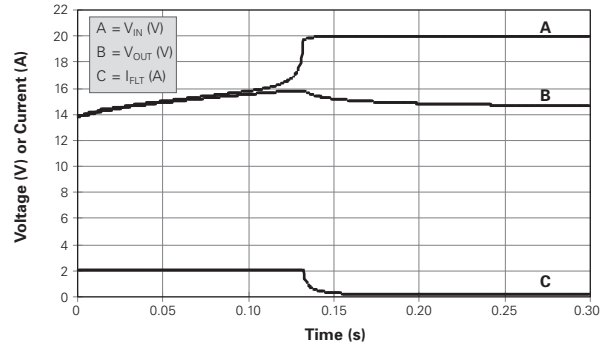
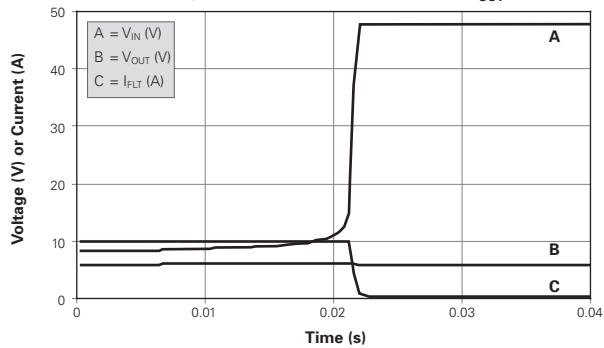
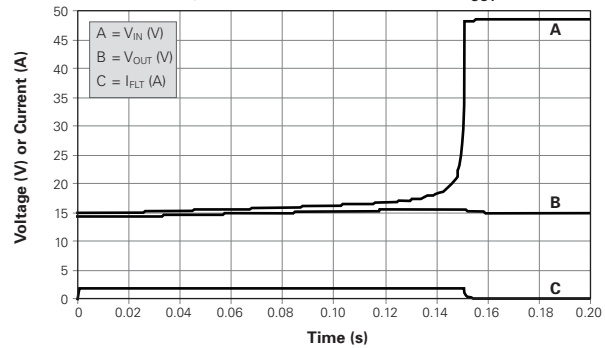

Figure PZ14



**Figure PZ16-PZ23 Basic Operation Examples for PolyZen Devices**

Cont'd

**Figure PZ15**
**Typical Fault Response: ZEN132V130A24LS**  
 24V, 2.0A Current Limited Source ( $I_{OUT}=0$ )

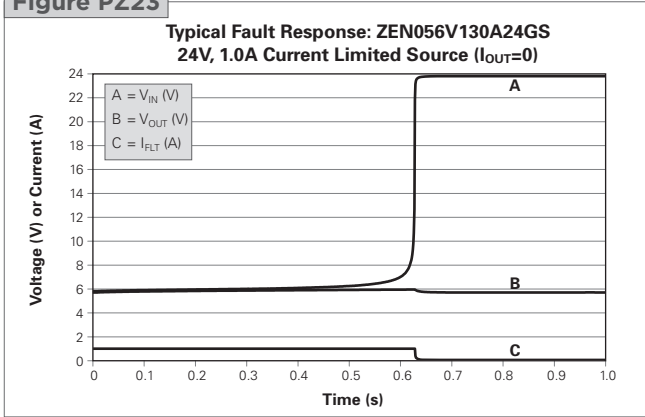
**Figure PZ16**
**Typical Fault Response: ZEN164V130A24LS**  
 24V, 1.0A Current Limited Source ( $I_{OUT}=0$ )

**Figure PZ17**
**Typical Fault Response: ZEN056V230A16LS**  
 16V, 5.0A Current Limited Source ( $I_{OUT}=0$ )

**Figure PZ18**
**Typical Fault Response: ZEN065V230A16LS**  
 16V, 3.5A Current Limited Source ( $I_{OUT}=0$ )

**Figure PZ19**
**Typical Fault Response: ZEN098V230A16LS**  
 16V, 3.5A Current Limited Source ( $I_{OUT}=0$ )

**Figure PZ20**
**Typical Fault Response: ZEN132V230A16LS**  
 20V, 2.0A Current Limited Source ( $I_{OUT}=0$ )

**Figure PZ21**
**Typical Fault Response: ZEN056V075A48LS**  
 48V, 10.0A Current Limited Source ( $I_{OUT}=0$ )

**Figure PZ22**
**Typical Fault Response: ZEN132V075A48LS**  
 48V, 2.0A Current Limited Source ( $I_{OUT}=0$ )

**Figure PZ23**

5

**Table PZ4 Packaging and Marking Information for PolyZen Devices**

Part Number	Bag Quantity	Tape & Reel Quantity	Standard Package
ZENxxxVyyyAzzLS	-	3,000	15,000
ZENxxxVyyyAzzGS	-	4,000	20,000

**Table PZ5 Dimensions for PolyZen Devices in Millimeters (Inches)**
**ZENxxxVyyyAzzLS Devices**

	A		B		C	
	Min.	Max.	Min.	Max.	Min.	Max.
mm	3.85	4.15	3.85	4.15	1.40	2.00
inch	(0.152)	(0.163)	(0.152)	(0.163)	(0.055)	(0.081)

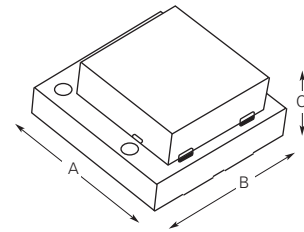

**ZENxxxVyyyAzzGS Devices**

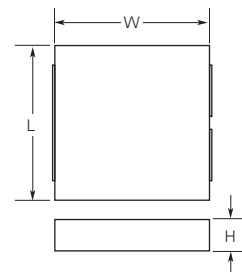
	L		W		H	
	Min.	Max.	Min.	Max.	Min.	Max.
mm	3.85	4.15	3.85	4.15	1.16	1.25
inch	(0.152)	(0.163)	(0.152)	(0.163)	(0.046)	(0.049)

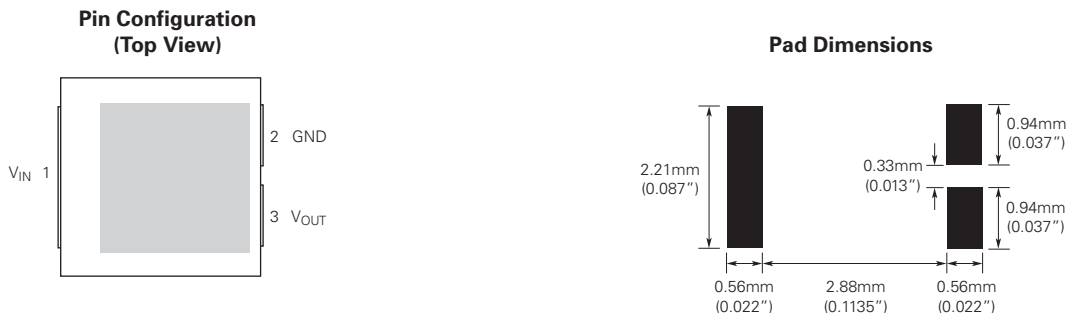

**Table PZ6 Pad Layout and Configuration Information for PolyZen Devices**

Pin Number	Pin Name	Pin Function
1	V <sub>IN</sub>	V <sub>IN</sub> = Protected input to Zener diode
2	GND	GND = Ground
3	V <sub>OUT</sub>	V <sub>OUT</sub> = Zener regulated voltage output

**Solder Reflow and Rework Recommendation for PolyZen Devices**
**Classification Reflow Profiles**

Profile Feature	Pb-Free Assembly
<b>Average ramp up rate (T<sub>S</sub><sub>MAX</sub> to T<sub>p</sub>)</b>	3°C/second max.
<b>Preheat</b>	
• Temperature min. (T <sub>S</sub> <sub>MIN</sub> )	150°C
• Temperature max. (T <sub>S</sub> <sub>MAX</sub> )	200°C
• Time (t <sub>S</sub> <sub>MIN</sub> to t <sub>S</sub> <sub>MAX</sub> )	60-180 seconds
<b>Time maintained above:</b>	
• Temperature (T <sub>L</sub> )	217°C
• Time (t <sub>L</sub> )	60-150 seconds
<b>Peak/Classification temperature (T<sub>p</sub>)</b>	260°C
<b>Time within 5°C of actual peak temperature</b>	
Time (t <sub>p</sub> )	20-40 seconds
<b>Ramp down rate</b>	6°C/second max.
<b>Time 25°C to peak temperature</b>	8 minutes max.

**Note:** All temperatures refer to topside of the package, measured on the package body surface.

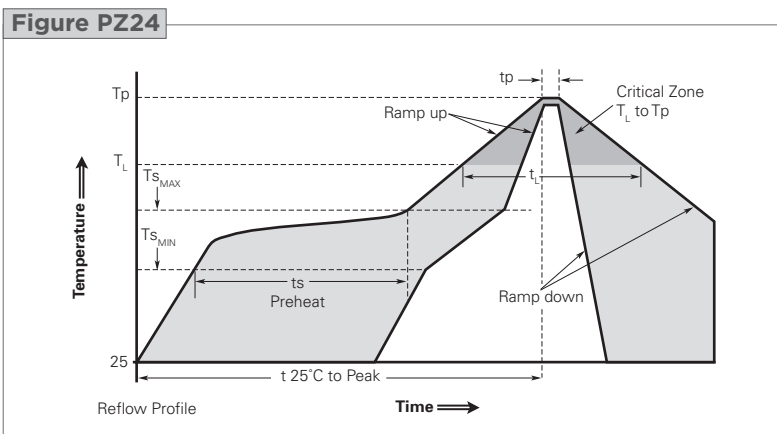

## Tape and Reel Specifications for PolyZen Devices (in Millimeters)

**Figure PZ25 EIA Referenced Taped Component Dimensions for PolyZen Devices (in Millimeters)**

Description	ZENxxxVyyyAzzLS Devices	ZENxxxVyyyAzzGS Devices
A <sub>0</sub>	4.35	4.35
B <sub>0</sub>	4.35	4.35
K <sub>0</sub>	2.30	1.80

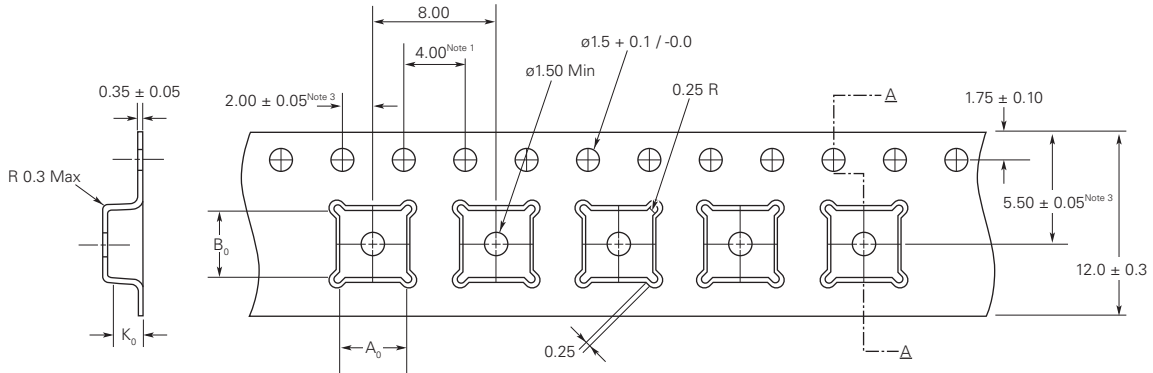

**Notes:**

1. 10 sprocket hole pitch cumulative tolerance  $\pm 0.2$
2. Camber in compliance with EIA 481
3. Pocket position relative to sprocket hole measured as true position of pocket, not pocket hole

**Figure PZ26 Reel Dimensions for PolyZen Devices (in Millimeters)**

Description	Dimension (mm)
A <sub>Max</sub>	330
N <sub>Min</sub>	102
W <sub>1</sub>	8.4
W <sub>2</sub>	11.1

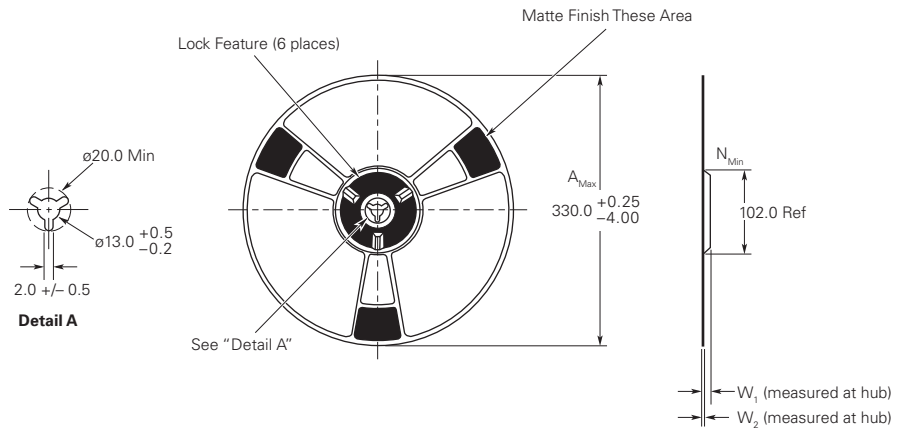

## Part Numbering System for PolyZen Devices

ZEN 056V 130A 24 LS & GS

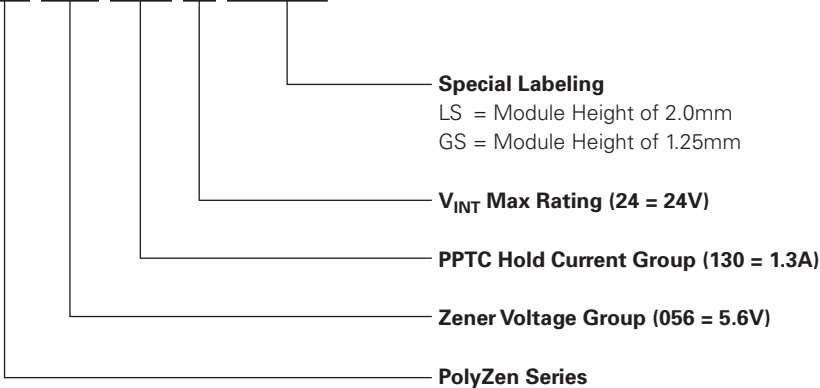

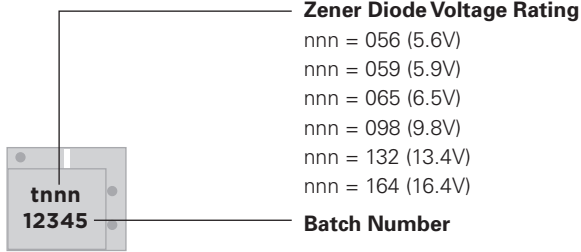
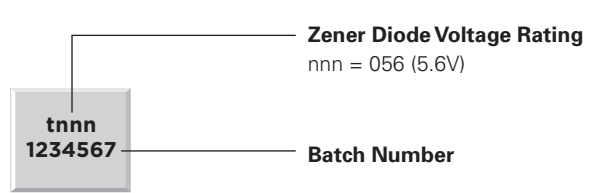

**Part Marking System for PolyZen Devices**
**ZENxxxVyyyAzzLS Devices**

**ZENxxxVyyyAzzGS Devices**

**Warning :**

All information, including illustrations, is believed to be accurate and reliable. Users, however, should independently evaluate the suitability of and test each product selected for their application. Tyco Electronics Corporation and/or its Affiliates in the TE Connectivity Ltd. family of companies ("TE") makes no warranties as to the accuracy or completeness of the information, and disclaims any liability regarding its use. TE's only obligations are those in the TE Standard Terms and Conditions of Sale for this product, and in no case will TE be liable for any incidental, indirect, or consequential damages arising from the sale, resale, use, or misuse of the product. Specifications are subject to change without notice. In addition, TE reserves the right to make changes to materials or processing that do not affect compliance with any applicable specification without notification to Buyer.

