

# XF FPC Connectors

Low-profile FPC Connectors with 0.3-mm / 0.4-mm / 0.5-mm pitch

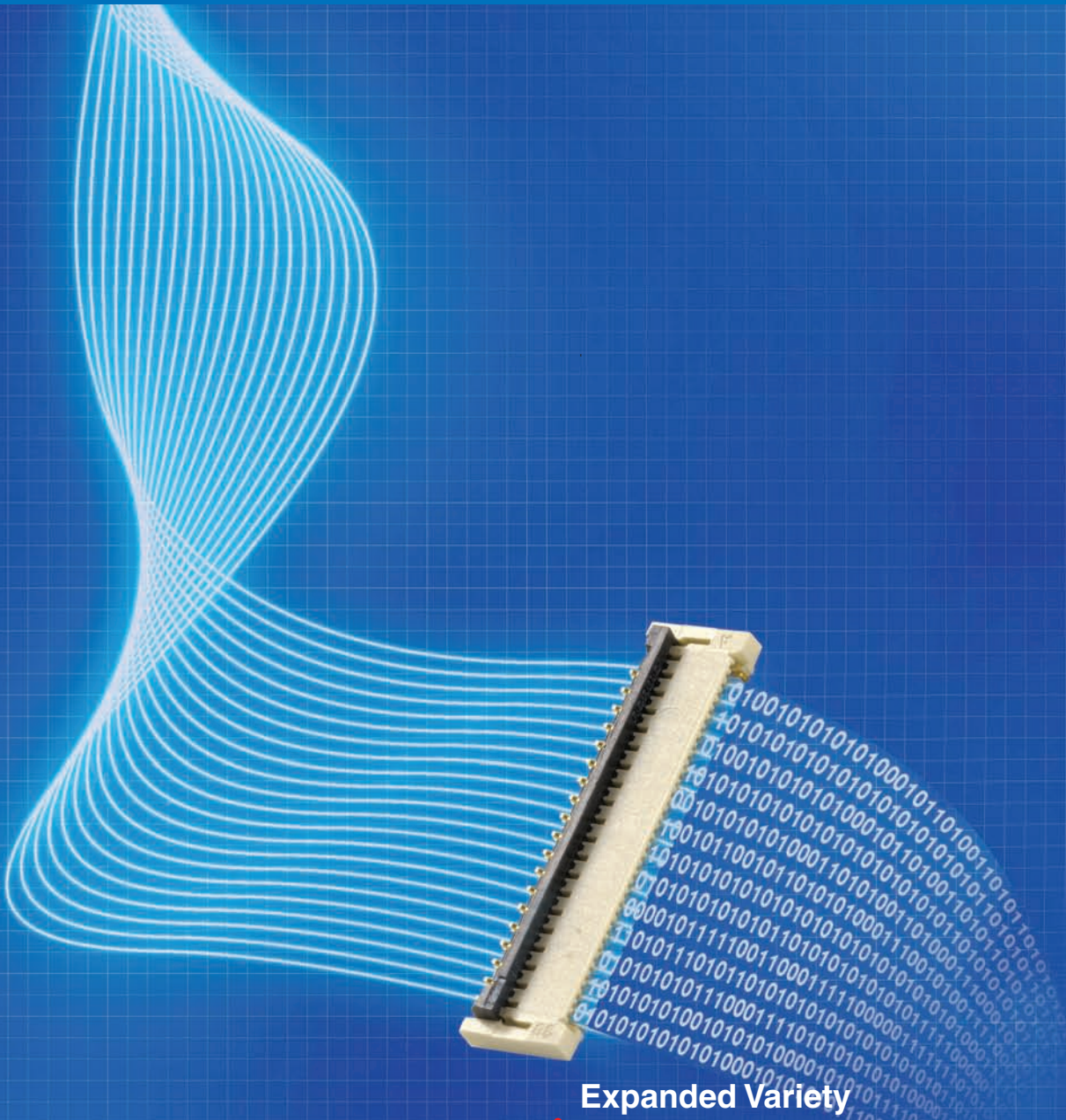

Expanded Variety

New Series Additions



# FPC See the Latest in FPC Connector Design and Technology

## XF Series

### XF2B

- 0.3 mm-pitch
- Profile of 1.2 mm
- Rotary backlock mechanism
- Double-sided contact

### XF2J

- 0.5 mm-pitch
- Profile of 4.15 mm
- Slide-locking mechanism
- Single-sided contact

### XF2L

- 0.5 mm-pitch
- Profile of 1.2 mm
- Slide-locking mechanism
- Lower contact

### XF2L

- 0.5 mm-pitch
- Profile of 1.2 mm
- Slide-locking mechanism
- Upper contact

### XF2K

- 0.4 mm-pitch
- Profile of 0.9 mm
- Rotary backlock mechanism
- Double-sided contact

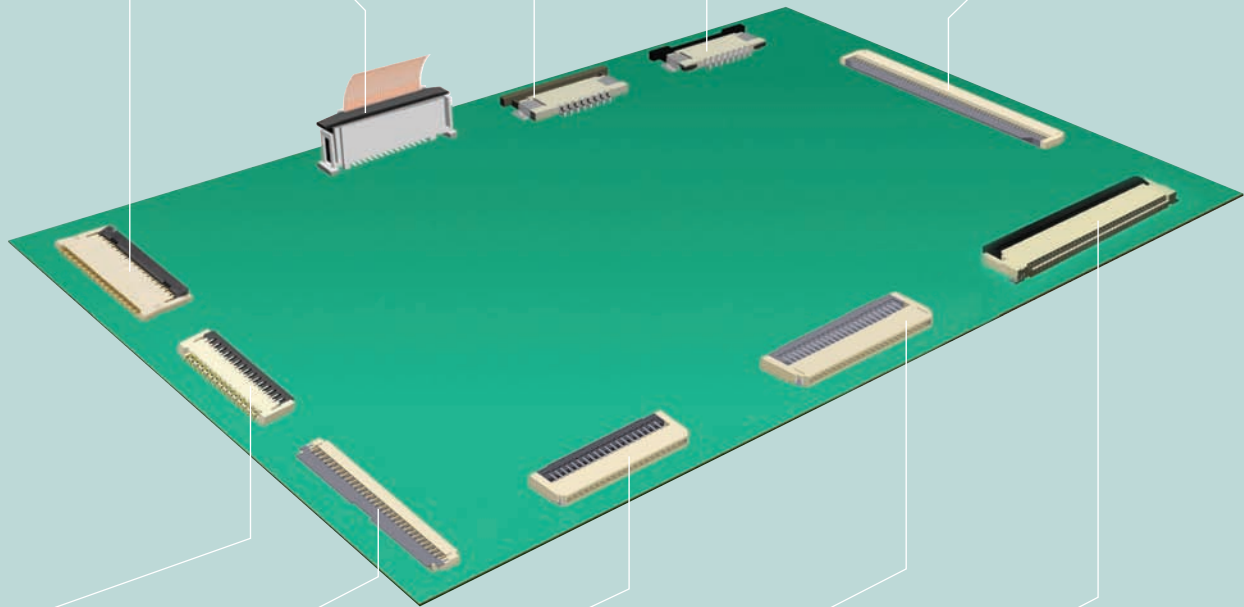

### XF2C

- 0.3 mm-pitch
- Profile of 0.9 mm
- Rotary backlock mechanism
- Upper contact

### XF3H

- 0.3 mm-pitch
- Profile of 0.9 mm
- Rotary frontlock mechanism
- Lower contact

### XF2U

- 0.5 mm-pitch
- Profile of 0.9 mm
- Rotary backlock mechanism
- Double-sided contact

### XF2W

- 0.5 mm-pitch
- Profile of 1.1 mm
- Rotary backlock mechanism
- Double-sided contact

### XF2M

- 0.5 mm-pitch
- Profile of 2 mm
- Rotary backlock mechanism
- Double-sided contact

## Applications

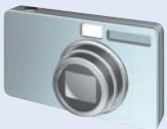

■ Digital cameras



■ Cell phones



■ Digital audio and video players



■ DVD players

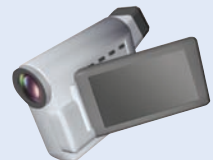







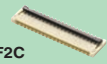

■ Digital video cameras

Omron's patented rotary backlock design solves FPC mounting problems and enhances work efficiency and reliability by providing easy operation during assembly and secure mounting even in tight spaces.

# INDEX

## Product Overview

Model	Lock mechanism	Pitch	On-board profile	Depth	Applicable FPC thickness	Contact type	Page
 XF2C	Rotary backlock	0.3 mm	0.9 mm	4.0 mm	0.12 mm	Upper contact	<a href="#">P6</a>
 XF2B	Rotary backlock	0.3 mm	1.2 mm	5.5 mm	0.2 mm	Double-sided contact (See note 1.)	<a href="#">P7</a>
 XF3H	Rotary frontlock	0.3 mm	0.9 mm	3.2 mm	0.2 mm	Lower contact	<a href="#">P9</a>
 XF2K	Rotary backlock	0.4 mm	0.9 mm	3.5 mm	0.2 mm	Double-sided contact	<a href="#">P11</a>
 XF2U	Rotary backlock	0.5 mm	0.9 mm	3.5 mm	0.2 mm	Double-sided contact	<a href="#">P12</a>
 XF2W	Rotary backlock	0.5 mm	1.1 mm	3.5 mm	0.3 mm	Double-sided contact	<a href="#">P13</a>
 XF2M	Rotary backlock	0.5 mm	2.0 mm (See note 2.)	5.9 mm (See note 2.)	0.3 mm	Double-sided contact	<a href="#">P15</a>
 XF2L	Slide lock	0.5 mm	1.2 mm	3.5 mm	0.3 mm	Upper/lower contact	<a href="#">P17</a>
 XF2J	Slide lock	0.5 mm	4.15 mm	3.4 mm	0.3 mm	Single-sided contact	<a href="#">P19</a>

Note 1: Models with 61 pins have upper contacts.

2: Specifications for models with 55 pins and those with 60 pins differ.

## Model Number Legend

Use this legend when determining the product specifications from the model number. Choose from the model numbers listed in this catalog when ordering.

**XF**       -             -          -   

(1)      (2)   (3) (4)   (5) (6) (7)   (8)

(1) Series Classification

2B, 2C, 2J, 2K, 2L, 2M, 2U, 2W, 3H

(2) Number of Signal Contact Pins

(3) Contact Arrangement

1: One-row, double-sided contact

2: One-row, single-sided contact

(including upper contact and top entry)

3: One-row, single-sided contact (lower contact)

4: Two-row, double-sided contact

5: Two-row, single-sided contact

(4) Terminal Shape

4: SMT terminals (top entry)

5: SMT terminals (side entry)

(5) Applicable FPC

Thickness

1: 0.3 mm

3: 0.2 mm

4: 0.12 mm

5: 0.15 mm

(6) Terminal Arrangement

@: Standard

1: Staggered arrangement

(forward arrangement)

2: Staggered arrangement

(reverse arrangement)

(7) Plating

A: Au

# Omron's Rotary Backlock Mechanism

## Improvement 1

Rotary slider independent of the FPC socket

- ➔ Slider does not disconnect if the FPC is lifted.
- High reliability--A mounted FPC will not come off if excess force is applied to it.

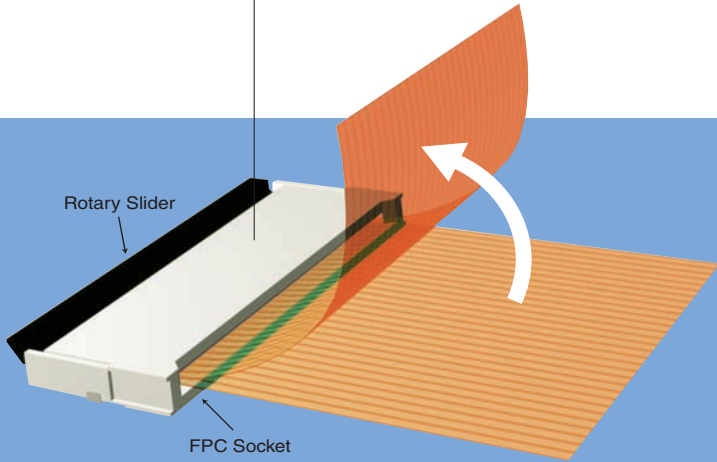

## Improvement 2

Four-sided FPC housing

- ➔ Construction prevents FPC displacement.
- Mounting reliability is enhanced because the FPC is held in a four-sided housing and is unaffected by the slider operation.

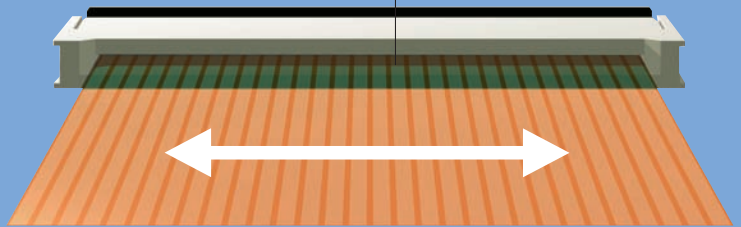

### Conventional Rotary Connector

1. Mount the connector.

2. Release the rotary slider.

3. Insert the FPC.

4. Lock the rotary slider.

### XF2 Series

1. Mount the connector.

2. Insert the FPC.

3. Lock the rotary slider.

## Improvement 3

Double-sided contact

Note: Except the XF2C and 61-pin XF2B-61.

- ➔ No need to discriminate between the upper and lower FPC contacts.
- Connectors are the same, so it's not necessary to distinguish between the upper and lower contacts when connecting upper and lower PCBs.

## Improvement 4

Delivered with the rotary slider open.

- ➔ Reduces the labor required to mount FPCs.
- Assembly speed is improved over the conventional rotary locking type because the rotary slider does not need to be released.

# Next-Generation Products

OMRON delivers cutting-edge innovative products a step ahead of customer needs. Please look forward to the continuing development of our new products.

## Ultra-slim FPC Connectors

Ultra-low profile with an on-board height of 0.5 mm.

- Ultra-slim construction supports LCR downsizing.
- The rotary front lock ensures operability.
- FPC locking mechanism improves contact reliability.

Under Development

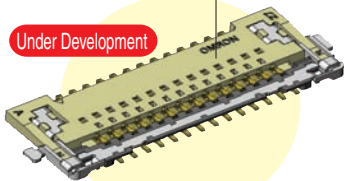

Application Illustration

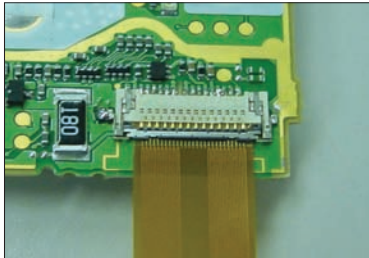

- Greatly Reduced On-board Profile

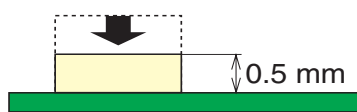

- Connector Specifications (Reference)

Pitch	0.3 mm
On-board profile	0.5 mm
FPC thickness	0.12 mm
Contact orientation	Upper contact
Lock mechanism	Rotary frontlock

- Designed for smaller mobile devices

Devices can now be downsized more than is possible with conventional connectors.

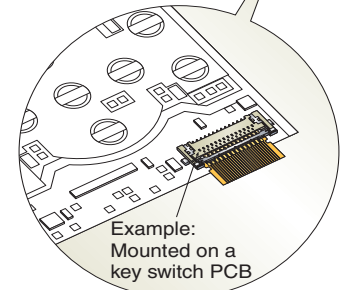
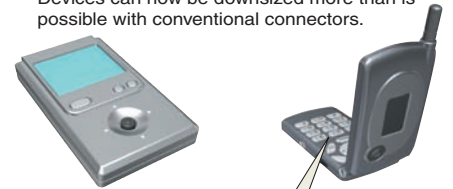

## F-to-F Connectors

Connecting FPC to FPC

- No mounting required: Boards can be designed more freely.
- Reliable contact even for open-air wiring.
- FPC temporary locking mechanism improves ease of operation.

Under Development

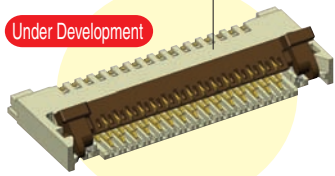

Application Illustration

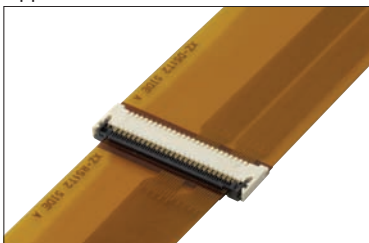

- Device Standardization

F-to-F connectors enable standardization of devices.

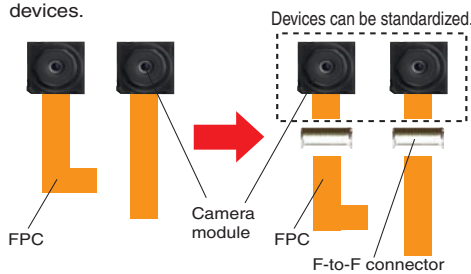

- Effective Use of Space Inside Devices.

F-to-F connectors do not require mounting, so available space can be used.

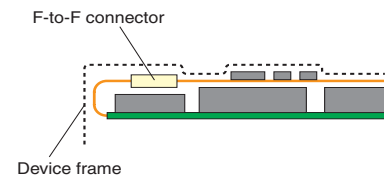

- Increased FPC Board Area Efficiency

F-to-F connectors enable FPCs to be separated for efficient use of PCB area.

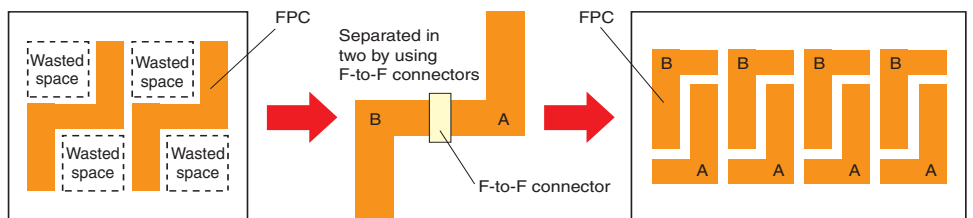

# Rotary Backlock Connector (0.3-mm Pitch, Upper Contact)

# XF2C

## Rotating Backlock Mechanism with 0.3-mm Pitch and Low Profile of 0.9 mm

- Wide molding wall on the rear bottom of the connector allows greater freedom in board design.
- Upper contact model.
- Gold plated with an applicable FPC thickness of 0.12 mm.

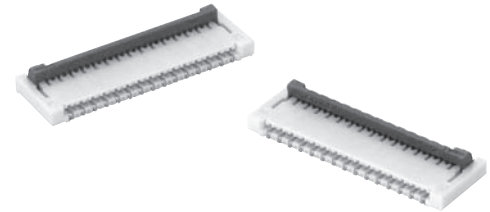

RoHS Compliant

## ■ Ratings and Specifications

Rated current	0.2 A AC/DC
Rated voltage	50 V AC/DC
Contact resistance	80 mΩ max. (at 20 mV max., 100 mA max.)
Insulation resistance	100 MΩ min. (at 250 V DC)
Withstand voltage	250 V AC for 1 min. (leakage current: 1 mA max.)
Insertion tolerance	10 times
Ambient operating temperature	-30 to 85°C (with no icing or condensation)

## ■ Materials and Finish

Housing	LCP resin (UL94V-0)/natural
Slider	LCP resin (UL94V-0)/black
Contacts	Spring copper alloy/nickel substrate (2 μm), gold-plated contacts (0.15 μm)

## ■ Dimensions

XF2C-□□55-41A

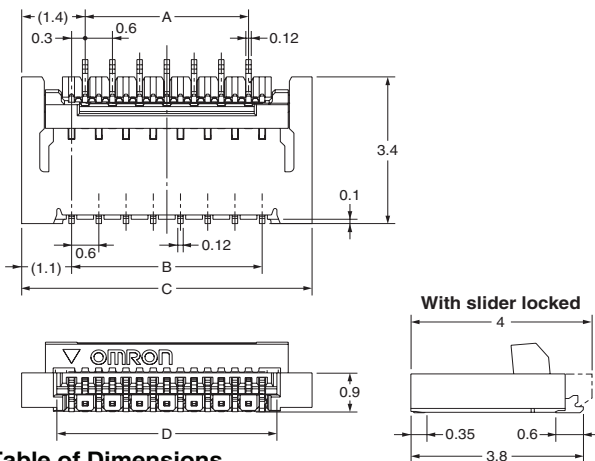
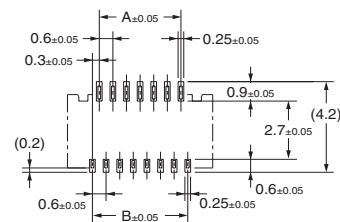

Table of Dimensions

Pins (See note 1.)	Model	A	B	C	D
17	XF2C-1755-41A	4.2	4.8	7.0	5.5
21	XF2C-2155-41A	5.4	6.0	8.2	6.7
25	XF2C-2555-41A	6.6	7.2	9.4	7.9
29	XF2C-2955-41A	7.8	8.4	10.6	9.1
35	XF2C-3555-41A	9.6	10.2	12.4	10.9
39	XF2C-3955-41A	10.8	11.4	13.6	12.1
45	XF2C-4555-41A	12.6	13.2	15.4	13.9
51	XF2C-5155-41A	14.4	15.0	17.2	15.7

## PCB Mating Dimensions (Top View)



## Applicable FPC Dimensions

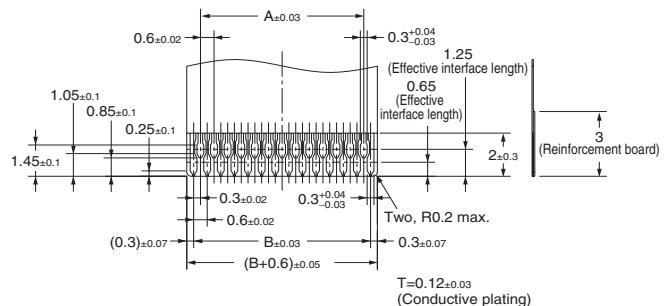

## ■ Ordering Information

Pins (See note 1.)	Model	Quantity per reel (See note 2.)
17	XF2C-1755-41A	2,000
21	XF2C-2155-41A	
25	XF2C-2555-41A	
29	XF2C-2955-41A	
35	XF2C-3555-41A	
39	XF2C-3955-41A	
45	XF2C-4555-41A	
51	XF2C-5155-41A	

- Note: 1.** The models with the number of pins in parentheses will be released in November 2006. Consult your OMRON representative for inquiries related to pin number specifications.
- 2.** Order an integer multiple of the quantity per reel.

### Pin Number Specifications

Refer to the following website for the latest information.  
<http://www.components.omron.com>

# Rotary Backlock Connector (0.3-mm Pitch, Double-sided Contact)

# XF2B

## Rotary Backlock Mechanism with 0.3-mm Pitch

- Wide molding wall on the rear bottom of the connector allows greater freedom in board design.
- Double-sided contact reduces the number of parts.
- Gold plated with an applicable FPC thickness of 0.2 mm.



RoHS Compliant

## ■ Ratings and Specifications

Rated current	0.2 A AC/DC
Rated voltage	50 V AC/DC
Contact resistance	50 mΩ max. (at 20 mV max., 100 mA max.)
Insulation resistance	100 MΩ min. (at 250 V DC)
Withstand voltage	250 V AC for 1 min. (leakage current: 1 mA max.)
Insertion tolerance	20 times
Ambient operating temperature	-30 to 85°C (with no icing or condensation)

## ■ Materials and Finish

Housing	LCP resin (UL94V-0)/natural
Slider	LCP resin (UL94V-0)/black
Contacts	Spring copper alloy/nickel substrate (2 μm), gold-plated contacts (0.15 μm)

## ■ Dimensions

XF2B-□□45-31A

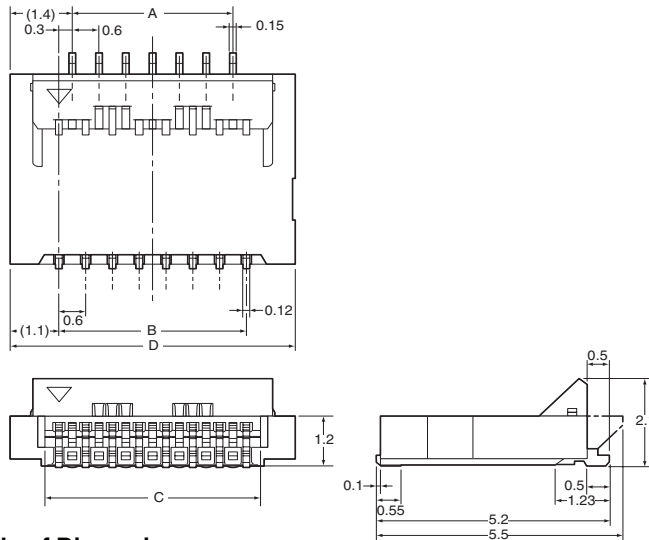

PCB Mating Dimensions (Top View)

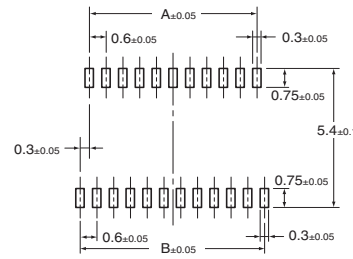

Applicable FPC Dimensions

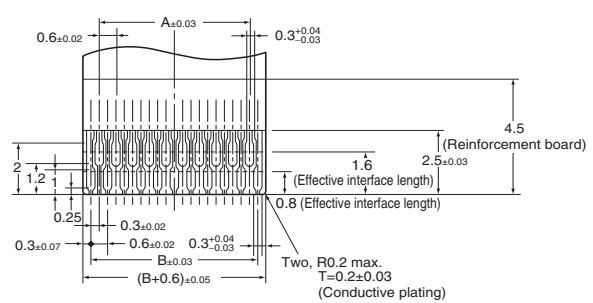

Table of Dimensions

Pins (See note 1.)	Model	A	B	C	D
17	XF2B-1745-31A	4.2	4.8	5.5	7.0
21	XF2B-2145-31A	5.4	6.0	6.7	8.2
23	XF2B-2345-31A	6.0	6.6	7.3	8.8
25	XF2B-2545-31A	6.6	7.2	7.9	9.4
27	XF2B-2745-31A	7.2	7.8	8.5	10.0
31	XF2B-3145-31A	8.4	9.0	9.7	11.2
33	XF2B-3345-31A	9.0	9.6	10.3	11.8
35	XF2B-3545-31A	9.6	10.2	10.9	12.4
39	XF2B-3945-31A	10.8	11.4	12.1	13.6
41	XF2B-4145-31A	11.4	12.0	12.7	14.2
45	XF2B-4545-31A	12.6	13.2	13.9	15.4
51	XF2B-5145-31A	14.4	15.0	15.7	17.2
61	XF2B-6155-31A	17.4	18.0	18.7	20.2

## ■ Ordering Information

Pins (See note 1.)	Model	Pins (See note 1.)	Model	Quantity per reel (See note 2.)
17	XF2B-1745-31A	35	XF2B-3545-31A	1,500
21	XF2B-2145-31A	39	XF2B-3945-31A	
23	XF2B-2345-31A	41	XF2B-4145-31A	
25	XF2B-2545-31A	45	XF2B-4545-31A	
27	XF2B-2745-31A	51	XF2B-5145-31A	
31	XF2B-3145-31A	61	XF2B-6155-31A (See note 3.)	
33	XF2B-3345-31A	---	---	

**Note: 1.** Consult your OMRON representative for inquiries related to pin number specifications.

**2.** Order an integer multiple of the quantity per reel.

**3.** Upper contact.

### Pin Number Specifications

Refer to the following website for the latest information. <http://www.components.omron.com>



# Rotary Frontlock Connector (0.3-mm Pitch, Lower Contact)

# XF3H

## Front-lock Mechanism with a Depth of 3.2 mm and Low Profile of 0.9 mm

- Ultra-slim connector with a depth of 3.2 mm.
- Wide molding wall on the rear bottom of the connector allows greater freedom in board design.
- Slider open locking mechanism makes work efficient.
- Gold plated with an applicable FPC thickness of 0.2 mm.

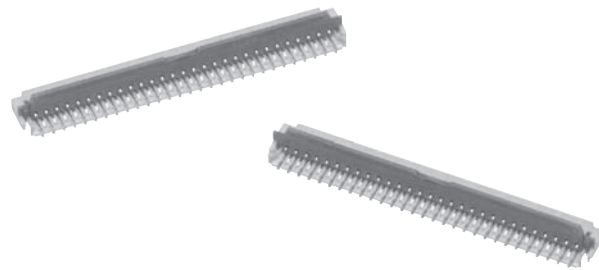

**NEW**

RoHS Compliant

## ■ Ratings and Specifications

Rated current	0.2 A AC/DC
Rated voltage	50 V AC/DC
Contact resistance	80 mΩ max. (at 20 mV max., 100 mA max.)
Insulation resistance	100 MΩ min. (at 250 V DC)
Withstand voltage	250 V AC for 1 min. (leakage current: 1 mA max.)
Insertion tolerance	10 times
Ambient operating temperature	-30 to 85°C (with no icing or condensation)

## ■ Materials and Finish

Housing	LCP resin (UL94V-0)/natural
Slider	LCP resin (UL94V-0)/brown
Contacts	Spring copper alloy/nickel substrate (2 μm), gold-plated contacts (0.15 μm)

## ■ Dimensions

XF3H-□□55-3A

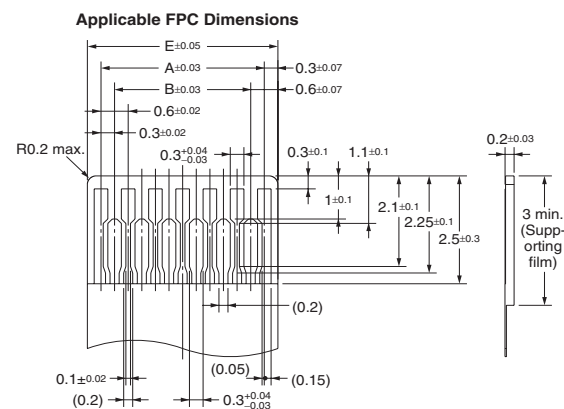
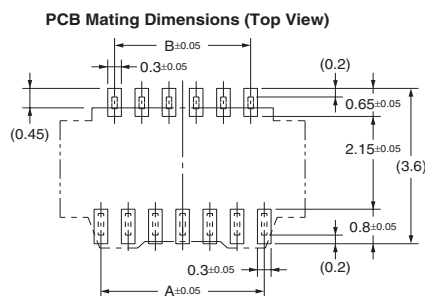
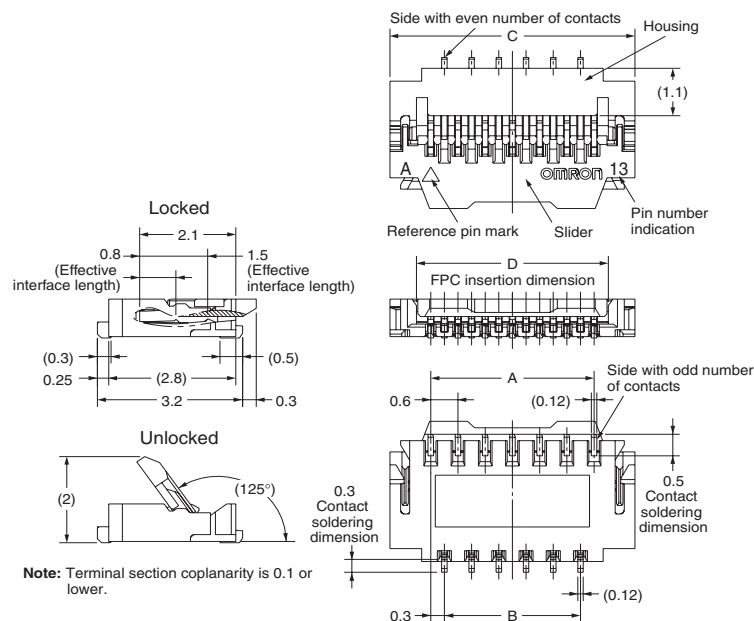

Table of Dimensions

Pins (See note 1.)	Model	A	B	C	D	E
25	XF3H-2555-3A	7.2	6.6	9.0	7.83	7.8
35	XF3H-3555-3A	10.2	9.6	12.0	10.83	10.8
39	XF3H-3955-3A	11.4	10.8	13.2	12.03	12.0
57	XF3H-5755-3A	16.8	16.2	18.6	17.43	17.4

## ■ Ordering Information

Pins (See note 1.)	Model	Quantity per reel (See note 2.)
25	XF3H-2555-3A	1,500
35	XF3H-3555-3A	
39	XF3H-3955-3A	
57	XF3H-5755-3A	

- Note: 1.** Consult your OMRON representative for inquiries related to pin number specifications for pin numbers not listed.
- 2.** Order an integer multiple of the quantity per reel.

### Pin Number Specifications

Refer to the following website for the latest information.  
<http://www.components.omron.com>

# Rotary Backlock Connector (0.4-mm Pitch, Double-sided Contact)

# XF2K

## Rotary Backlock Mechanism with a Depth of 0.4 mm and Low Profile of 0.9 mm

- Long slider makes it easier to lock and unlock the connector.
- Double-sided contacts reduce the number of parts.
- Gold plated with an applicable FPC thickness of 0.2 mm.

RoHS Compliant



**NEW**

## ■ Ratings and Specifications

<b>Rated current</b>	0.2 A AC/DC
<b>Rated voltage</b>	50 V AC/DC
<b>Contact resistance</b>	60 mΩ max. (at 20 mV max., 100 mA max.)
<b>Insulation resistance</b>	100 MΩ min. (at 250 V DC)
<b>Withstand voltage</b>	250 V AC for 1 min (leakage current: 1 mA max.)
<b>Insertion tolerance</b>	20 times
<b>Ambient operating temperature</b>	-30 to 85°C (with no icing or condensation)

## ■ Materials and Finish

<b>Housing</b>	LCP resin (UL94V-0)/natural
<b>Slider</b>	LCP resin (UL94V-0)/brown
<b>Contacts</b>	Spring copper alloy/nickel substrate (2 μm), gold-plated contacts (0.15 μm)
<b>Hold-down</b>	Spring copper alloy/fused-tin plating (2 μm)

## ■ Dimensions

XF2K-□□15-3AE

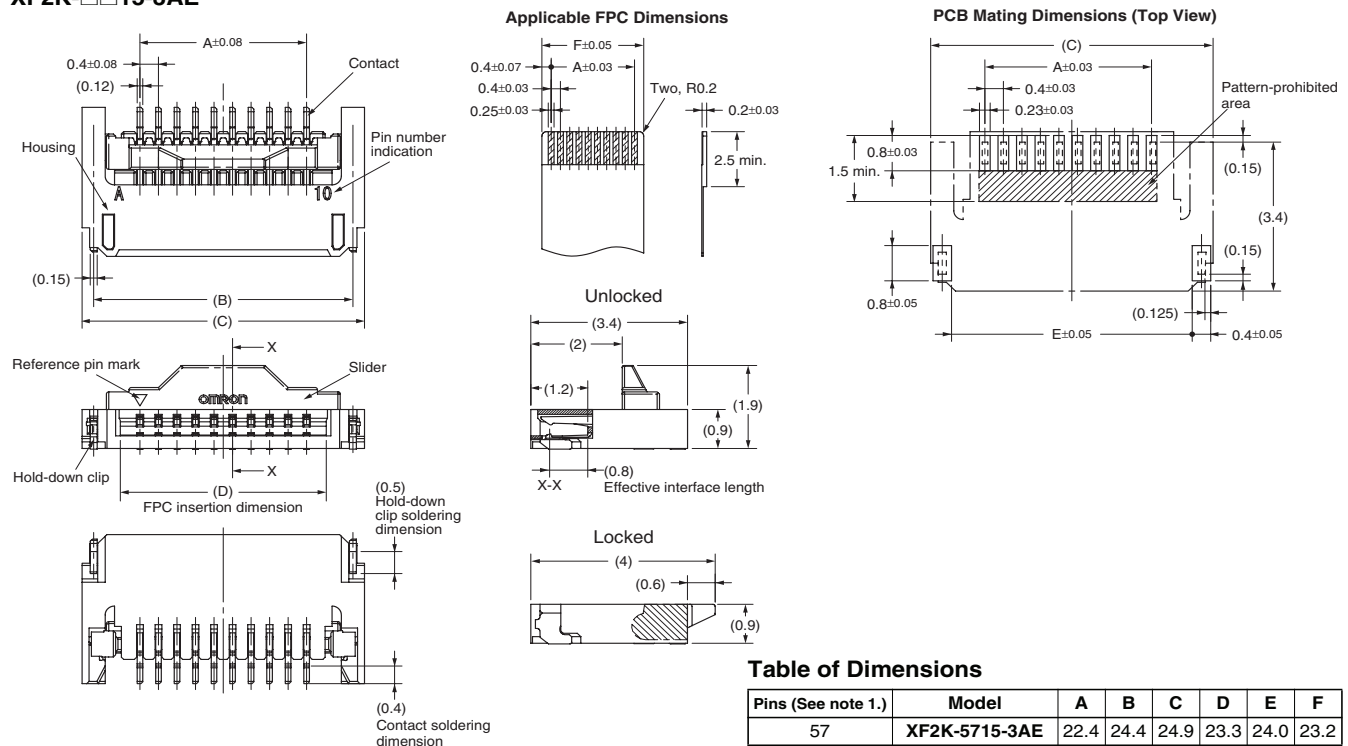

## ■ Ordering Information

Pins (See note 1.)	Model	Quantity per reel (See note 2.)
57	XF2K-5715-3AE	2,000

- Note: 1.** Consult your OMRON representative for inquiries related to pin number specifications.
- 2.** Order an integer multiple of the quantity per reel.

### Pin Number Specifications

Refer to the following website for the latest information.  
<http://www.components.omron.com>

# Rotary Backlock Connector (0.5-mm Pitch, Double-sided Contact)

# XF2U

## Rotary Backlock Mechanism with a Depth of 3.5 mm and Low Profile of 0.9 mm

- Ultra-slim connector with a depth of 3.5 mm.
- Double-sided contacts reduce the number of parts.
- Wide molding wall on the rear bottom of the connector allows greater freedom in board design.
- Gold plated with an applicable FPC thickness of 0.2 mm.

RoHS Compliant

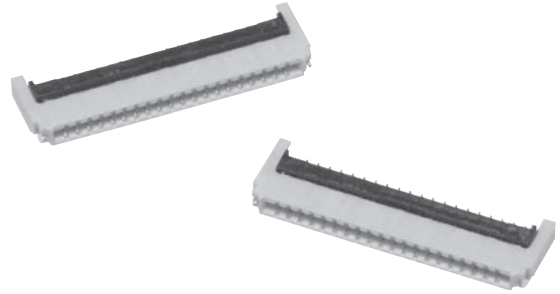

## ■ Ratings and Specifications

Rated current	0.5 A AC/DC
Rated voltage	50 V AC/DC
Contact resistance	60 mΩ max. (at 20 mV max., 100 mA max.)
Insulation resistance	100 MΩ min. (at 250 V DC)
Withstand voltage	250 V AC for 1 min (leakage current: 1 mA max.)
Insertion tolerance	20 times
Ambient operating temperature	-30 to 85°C (with no icing or condensation)

## ■ Materials and Finish

Housing	LCP resin (UL94V-0)/natural
Slider	LCP resin (UL94V-0)/black
Contacts	Spring copper alloy/nickel substrate (2 μm), gold-plated contacts (0.15 μm)
Hold-down	Spring copper alloy/fused-tin plating (2 μm)

## ■ Dimensions

XF2U-□□15-3A

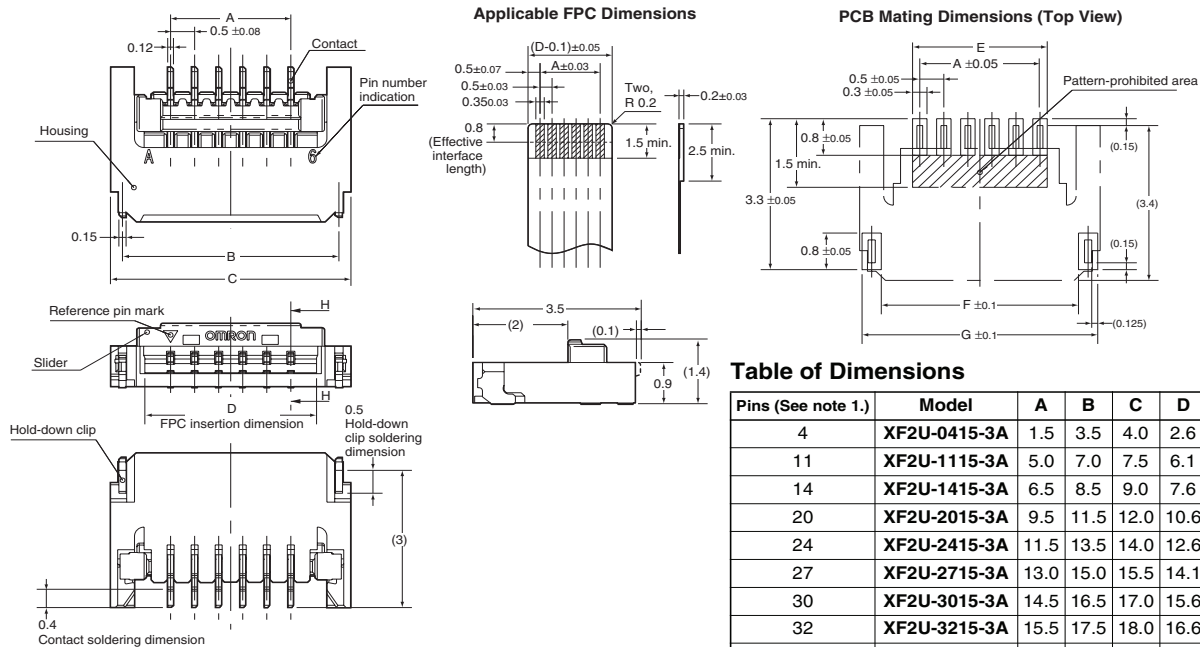

Table of Dimensions

Pins (See note 1.)	Model	A	B	C	D	E	F	G
4	XF2U-0415-3A	1.5	3.5	4.0	2.6	1.8	3.1	3.9
11	XF2U-1115-3A	5.0	7.0	7.5	6.1	5.3	6.6	7.4
14	XF2U-1415-3A	6.5	8.5	9.0	7.6	6.8	8.1	8.9
20	XF2U-2015-3A	9.5	11.5	12.0	10.6	9.8	11.1	11.9
24	XF2U-2415-3A	11.5	13.5	14.0	12.6	11.8	13.1	13.9
27	XF2U-2715-3A	13.0	15.0	15.5	14.1	13.3	14.6	15.4
30	XF2U-3015-3A	14.5	16.5	17.0	15.6	14.8	16.1	16.9
32	XF2U-3215-3A	15.5	17.5	18.0	16.6	15.8	17.1	17.9
40	XF2U-4015-3A	19.5	21.5	22.0	20.6	19.8	21.1	21.9

## ■ Ordering Information

Pins (See note 1.)	Model	Quantity per reel (See note 2.)
4	XF2U-0415-3A	3,000
11	XF2U-1115-3A	
14	XF2U-1415-3A	
20	XF2U-2015-3A	
24	XF2U-2415-3A	
27	XF2U-2715-3A	
30	XF2U-3015-3A	
32	XF2U-3215-3A	
40	XF2U-4015-3A	

**Note: 1.** Consult your OMRON representative for inquiries related to pin number specifications.  
**2.** Order an integer multiple of the quantity per reel.

### Pin Number Specifications

Refer to the following website for the latest information.  
<http://www.components.omron.com>

# Rotary Backlock Connector (0.5-mm Pitch, Double-sided Contact)

# XF2W

## Rotary Backlock Mechanism with 0.5-mm Pitch and Low Profile of 1.1 mm

- Two models available: Ultra-slim connector with a depth of 3.5 mm and easy-operation connector with long slider.
- Double-sided contacts reduce the number of parts.
- Wide molding wall on the rear bottom of the connector allows greater freedom in board design.
- Applicable FPC thickness of 0.3 mm.

**NEW**

**RoHS Compliant**

## ■ Ratings and Specifications

XF2W-□□15-1A/1AE

Rated current	0.5 A AC/DC
Rated voltage	50 V AC/DC
Contact resistance	60 mΩ max. (at 20 mV max., 100 mA max.)
Insulation resistance	100 MΩ min. (at 250 V DC)
Withstand voltage	250 V AC for 1 min (leakage current: 1 mA max.)
Insertion tolerance	20 times
Ambient operating temperature	-30 to 85°C (with no icing or condensation)

## ■ Materials and Finish

XF2W-□□15-1A/1AE

Housing	LCP resin (UL94V-0)/natural
Slider	LCP resin (UL94V-0)/brown
Contacts	Spring copper alloy/nickel substrate (2 μm), gold-plated contacts (0.15 μm)
Hold-down	Spring copper alloy/fused-tin plating (2 μm)

## ■ Dimensions

XF2W-□□15-1□  
XF2W-□□15-1□E

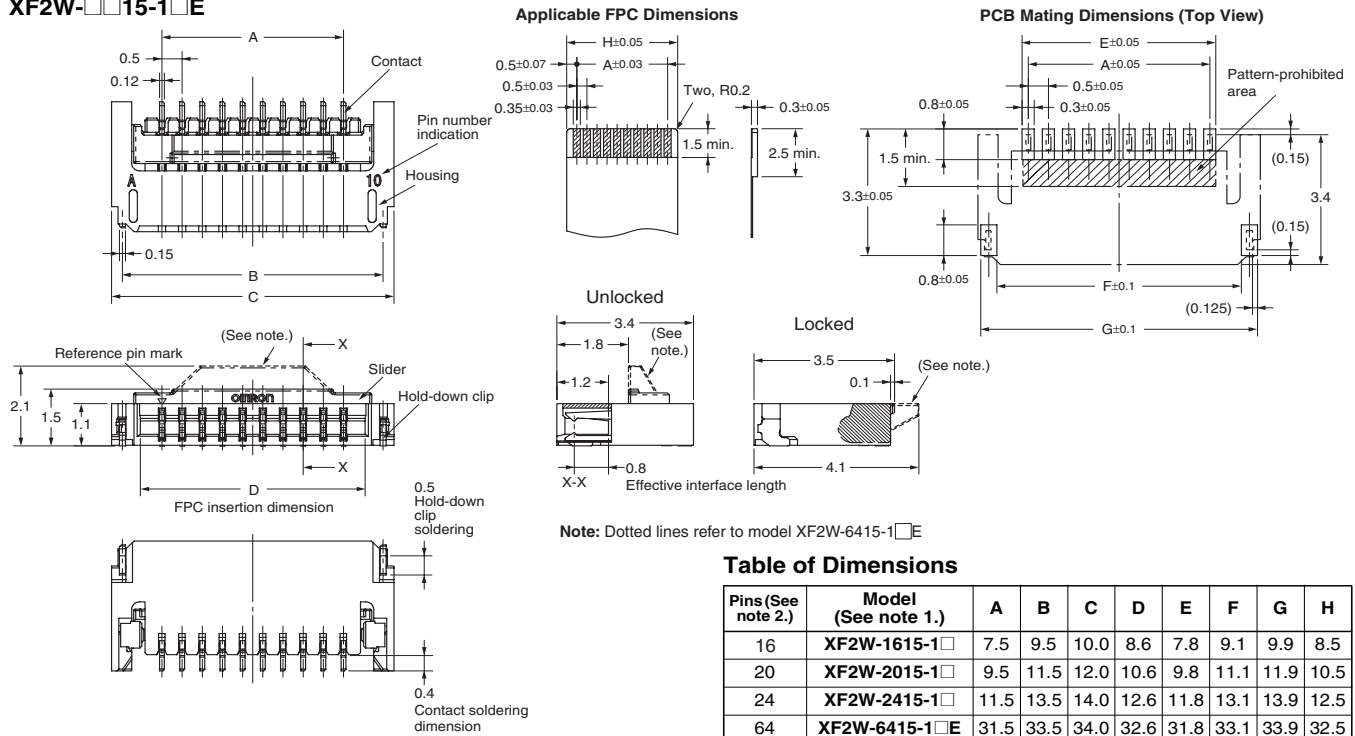

**Table of Dimensions**

Pins (See note 2.)	Model (See note 1.)	A	B	C	D	E	F	G	H
16	XF2W-1615-1□	7.5	9.5	10.0	8.6	7.8	9.1	9.9	8.5
20	XF2W-2015-1□	9.5	11.5	12.0	10.6	9.8	11.1	11.9	10.5
24	XF2W-2415-1□	11.5	13.5	14.0	12.6	11.8	13.1	13.9	12.5
64	XF2W-6415-1□E	31.5	33.5	34.0	32.6	31.8	33.1	33.9	32.5

Note: "E" refers to the shape and dimensions for model series XF2W-6415. Please refer to the drawings for more information.

## ■ Ordering Information

Pins (See note 2.)	Model (See note 1.)	Quantity per reel (See note 3.)
16	XF2W-1615-1□	2,000
20	XF2W-2015-1□	
24	XF2W-2415-1□	
64	XF2W-6415-1□E	

Note: "E" refers to the shape and dimensions for model series XF2W-6415. Please refer to the drawings for more information.

**Note: 1.** The symbol in the box at the end of the model number indicates the type of plating.  
 A: Gold-plated (RoHS compliant) The end of the model number indicates the slider specification.  
 None: Standard, E: Multiple pins

**2.** Consult your OMRON representative for inquiries related to pin number specifications for pin numbers not listed.

**3.** Order an integer multiple of the quantity per reel.

### Pin Number Specifications

Refer to the following website for the latest information. <http://www.components.omron.com>

# Rotary Backlock Connector (0.5-mm Pitch, Double-sided Contact)

# XF2M

Rotary Lock Achieves High Reliability and Superior Work Efficiency.

- Double-sided contact reduces the number of parts.
- Applicable FPC thickness of 0.3 mm.

RoHS Compliant

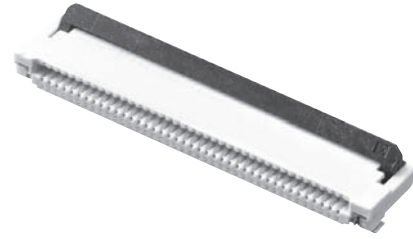

## ■ Ratings and Specifications

XF2M-□□15-1A/1AH

Rated current	0.5 A AC/DC
Rated voltage	50 V AC/DC
Contact resistance	50 mΩ max. (at 20 mV max., 100 mA max.)
Insulation resistance	100 MΩ min. (at 250 V DC)
Withstand voltage	250 V AC for 1 min. (leakage current: 1 mA max.)
Insertion tolerance	20 times
Ambient operating temperature	-30 to 85°C (with no icing or condensation)

## ■ Materials and Finish

XF2M-□□15-1A/1AH

Housing	LCP resin (UL94V-0)/natural
Slider	LCP resin (UL94V-0)/black
Contacts	Spring copper alloy/nickel substrate (2 μm), gold-plated contacts (0.15 μm)
Hold-down	Spring copper alloy/fused-tin plating (1.5 μm)

## ■ Dimensions

XF2M-□□15-1□

XF2M-□□15-1□H

Table of Dimensions

Pins (See note 2.)	Model (See note 1.)	A	B	C	D	E	F	G
10	XF2M-1015-1□	4.5	5.6	8.5	9.1	7.1	6.1	9.5
12	XF2M-1215-1□	5.5	6.6	9.5	10.1	8.1	7.1	10.5
14	XF2M-1415-1□	6.5	7.6	10.5	11.1	9.1	8.1	11.5
18	XF2M-1815-1□	8.5	9.6	12.5	13.1	11.1	10.1	13.5
20	XF2M-2015-1□	9.5	10.6	13.5	14.1	12.1	11.1	14.5
22	XF2M-2215-1□	10.5	11.6	14.5	15.1	13.1	12.1	15.5
24	XF2M-2415-1□	11.5	12.6	15.5	16.1	14.1	13.1	16.5
26	XF2M-2615-1□	12.5	13.6	16.5	17.1	15.1	14.1	17.5
30	XF2M-3015-1□	14.5	15.6	18.5	19.1	17.1	16.1	19.5
32	XF2M-3215-1□	15.5	16.6	19.5	20.1	18.1	17.1	20.5
33	XF2M-3315-1□	16.0	17.1	20.0	20.6	18.6	17.6	21.0
34	XF2M-3415-1□	16.5	17.6	20.5	21.1	19.1	18.1	21.5
35	XF2M-3515-1□	17.0	18.1	21.0	21.6	19.6	18.6	22.0
36	XF2M-3615-1□	17.5	18.6	21.5	22.1	20.1	19.1	22.5
38	XF2M-3815-1□	18.5	19.6	22.5	23.1	21.1	20.1	23.5
40	XF2M-4015-1□	19.5	20.6	23.5	24.1	22.1	21.1	24.5
42	XF2M-4215-1□	20.5	21.6	24.5	25.1	23.1	22.1	25.5
45	XF2M-4515-1□	22.0	23.1	26.0	26.6	24.6	23.6	27.0
50	XF2M-5015-1□	24.5	25.6	28.5	29.1	27.1	26.1	29.5
55	XF2M-5515-1□H	27.0	28.1	31.0	31.6	29.6	28.6	32.0
60	XF2M-6015-1□H	29.5	30.6	33.5	34.1	32.1	31.1	34.5

Note: Dotted lines refer to the shape and dimensions of models XF2M-5515-1□H and 6015-1□H.

Note: "H" refers to the shape and dimensions for model series XF2M-5515 and 6015. Please refer to the drawings for more information.

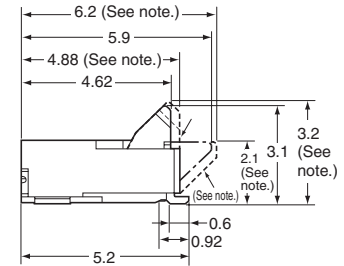
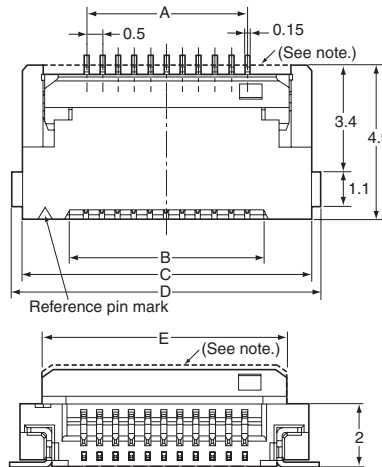

PCB Mating Dimensions (Top View)

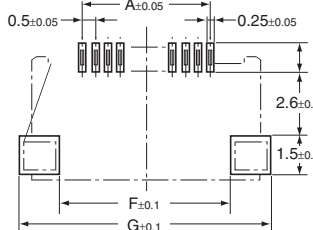

Applicable FPC Dimensions

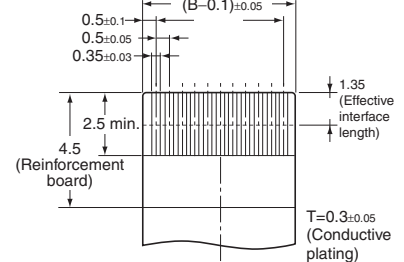

## ■ Ordering Information

Pins (See note 2.)	Model (See note 1.)	Pins (See note 2.)	Model (See note 1.)	Pins (See note 2.)	Model (See note 1.)	Quantity per reel (See note 3.)
10	XF2M-1015-1□	26	XF2M-2615-1□	38	XF2M-3815-1□	1,500
12	XF2M-1215-1□	30	XF2M-3015-1□	40	XF2M-4015-1□	
14	XF2M-1415-1□	32	XF2M-3215-1□	42	XF2M-4215-1□	
18	XF2M-1815-1□	33	XF2M-3315-1□	45	XF2M-4515-1□	
20	XF2M-2015-1□	34	XF2M-3415-1□	50	XF2M-5015-1□	
22	XF2M-2215-1□	35	XF2M-3515-1□	55	XF2M-5515-1□H	
24	XF2M-2415-1□	36	XF2M-3615-1□	60	XF2M-6015-1□H	

- Note: 1.** The symbol in the box at the end of the model number indicates the type of plating.  
 A: Gold-plated (RoHS compliant).  
 The end of the model number indicates the slider specification.  
 None: Standard, H: For multiple pins
- 2.** Consult your OMRON representative for inquiries related to pin number specifications for pin numbers not listed.
- 3.** Order an integer multiple of the quantity per reel. Small-lot orders (for 100 units) can also be accepted. When ordering, specify model numbers ending with R-100 for 100 units.
- 4.** Consult your OMRON representative for inquiries about lead-free tin solder.
- 5.** Solder plating (specified by -1L at the end of the model number) ended production March 2000 and is no longer available.
- 6.** "H" refers to the shape and dimensions for model series XF2M-5515 and 6015. Please refer to the Dimensions for more information.

### Pin Number Specifications

Refer to the following website for the latest information. <http://www.components.omron.com>



# ZIF Slide-locking Connector (0.5-mm Pitch)

# XF2L

## Greater Freedom in Board Design with a Bottom Wall and the Smallest On-board Area in the Industry

- Smallest on-board area and volume in the industry.
- Low on-board profile of only 1.2 mm.
- Highest board design surface efficiency in the industry with a bottom wall preventing terminal exposure.
- Construction with secure slider locking mechanism.
- Applicable FPC thickness of 0.3 mm.



RoHS Compliant

## ■ Ratings and Specifications

XF2L-□□□5-1A

<b>Rated current</b>	0.5 A AC/DC
<b>Rated voltage</b>	50 V AC/DC
<b>Contact resistance</b>	30 mΩ max. (at 20 mV DC max., 100 mA max.)
<b>Insulation resistance</b>	100 MΩ min. (at 250 V DC)
<b>Withstand voltage</b>	250V AC for 1 min. (leakage current: 1 mA max.)
<b>Insertion tolerance</b>	20 times
<b>Ambient operating temperature</b>	-30 to 85°C (with no icing or condensation)

## ■ Materials and Finish

XF2L-□□□5-1A

Model	XF2L (Upper-contact Models)	XF2L (Lower-contact Models)
<b>Ordering</b>	(Upper-contact Models)	(Lower-contact Models)
<b>Housing</b>	LCP resin (UL94V-0)/natural	
<b>Slider</b>	LCP resin (UL94V-0)/black	LCP resin (UL94V-0)/brown
<b>Contacts</b>	Spring copper alloy/nickel substrate (2 μm), gold-plated contacts (0.15 μm)	
<b>Hold-down</b>	Spring copper alloy/fused-tin plating (1.5 μm)	

## ■ Dimensions

XF2L-□□□5-1□

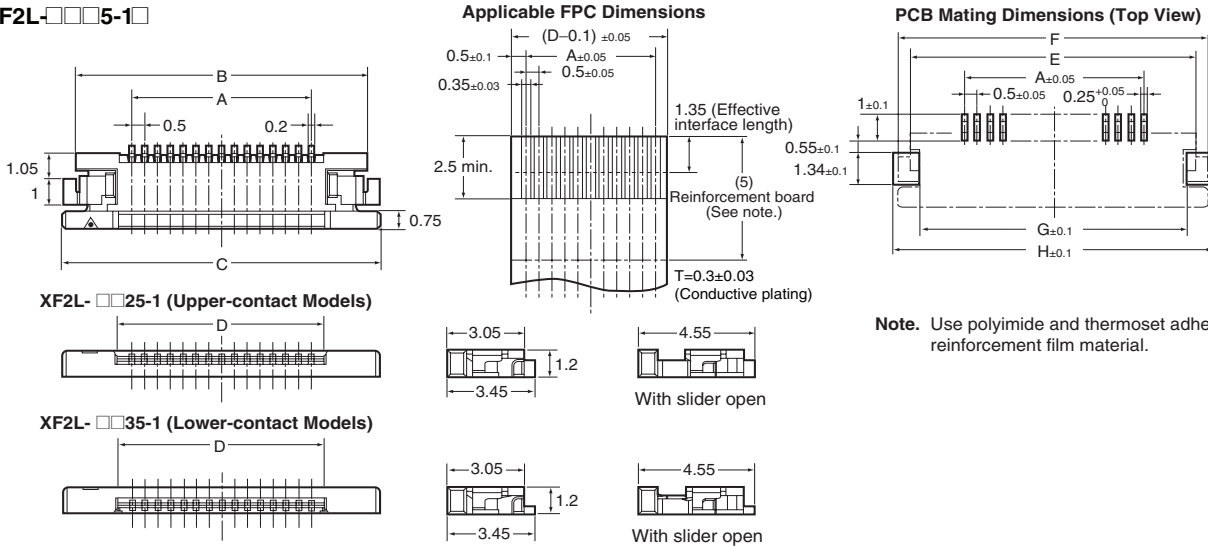

Table of Dimensions  
Upper-contact Models

Pins (See note 2.)	Model (See note 1.)	A	B	C	D	E	F	G	H
4	XF2L-0425-1□	1.5	5.9	6.9	2.6	5.88	6.88	5.28	7.28
6	XF2L-0625-1□	2.5	6.9	7.9	3.6	6.88	7.88	6.28	8.28
7	XF2L-0725-1□	3.0	7.4	8.4	4.1	7.38	8.38	6.78	8.78
8	XF2L-0825-1□	3.5	7.9	8.9	4.6	7.88	8.88	7.28	9.28
9	XF2L-0925-1□	4.0	8.4	9.4	5.1	8.38	9.38	7.78	9.78
10	XF2L-1025-1□	4.5	8.9	9.9	5.6	8.88	9.88	8.28	10.28
12	XF2L-1225-1□	5.5	9.9	10.9	6.6	9.88	10.88	9.28	11.28
13	XF2L-1325-1□	6.0	10.4	11.4	7.1	10.38	11.38	9.78	11.78
18	XF2L-1825-1□	8.5	12.9	13.9	9.6	12.88	13.88	12.28	14.28
21	XF2L-2125-1□	10.0	14.4	15.4	11.1	14.38	15.38	13.78	15.78
26	XF2L-2625-1□	12.5	16.9	17.9	13.6	16.88	17.88	16.28	18.28
30	XF2L-3025-1□	14.5	18.9	19.9	15.6	18.88	19.88	18.28	20.28

Lower-contact Models

Pins (See note 2.)	Model (See note 1.)	A	B	C	D	E	F	G	H
5	XF2L-0535-1□	2.0	6.4	7.4	3.1	6.38	7.38	5.78	7.78
6	XF2L-0635-1□	2.5	6.9	7.9	3.6	6.88	7.88	6.28	8.28
7	XF2L-0735-1□	3.0	7.4	8.4	4.1	7.38	8.38	6.78	8.78
8	XF2L-0835-1□	3.5	7.9	8.9	4.6	7.88	8.88	7.28	9.28
10	XF2L-1035-1□	4.5	8.9	9.9	5.6	8.88	9.88	8.28	10.28
12	XF2L-1235-1□	5.5	9.9	10.9	6.6	9.88	10.88	9.28	11.28
13	XF2L-1335-1□	6.0	10.4	11.4	7.1	10.38	11.38	9.78	11.78
15	XF2L-1535-1□	7.0	11.4	12.4	8.1	11.38	12.38	10.78	12.78
18	XF2L-1835-1□	8.5	12.9	13.9	9.6	12.88	13.88	12.28	14.28
19	XF2L-1935-1□	9.0	13.4	14.4	10.1	13.38	14.38	12.78	14.78
20	XF2L-2035-1□	9.5	13.9	14.9	10.6	13.88	14.88	13.28	15.28
22	XF2L-2235-1□	10.5	14.9	15.9	11.6	14.88	15.88	14.28	16.28
24	XF2L-2435-1□	11.5	15.9	16.9	12.6	15.88	16.88	15.28	17.28
30	XF2L-3035-1□	14.5	18.9	19.9	15.6	18.88	19.88	18.28	20.28

## ■ Ordering Information

Pins (See note 2.)	Type	Model (See note 1.)	Pins (See note 2.)	Type	Model (See note 1.)	Pins (See note 2.)	Type	Model (See note 1.)	Quantity per reel (See note 3.)
4	Upper-contact	XF2L-0425-1□	10	Upper-contact	XF2L-1025-1□	19	Lower-contact	XF2L-1935-1□	3,000
5	Lower-contact	XF2L-0535-1□		Lower-contact	XF2L-1035-1□	20	Lower-contact	XF2L-2035-1□	
6	Upper-contact	XF2L-0625-1□	12	Upper-contact	XF2L-1225-1□	21	Upper-contact	XF2L-2125-1□	
	Lower-contact	XF2L-0635-1□		Lower-contact	XF2L-1235-1□	22	Lower-contact	XF2L-2235-1□	
7	Upper-contact	XF2L-0725-1□	13	Upper-contact	XF2L-1325-1□	24	Lower-contact	XF2L-2435-1□	
	Lower-contact	XF2L-0735-1□		Lower-contact	XF2L-1335-1□	26	Upper-contact	XF2L-2625-1□	
8	Upper-contact	XF2L-0825-1□	15	Lower-contact	XF2L-1535-1□	30	Upper-contact	XF2L-3025-1□	
	Lower-contact	XF2L-0835-1□	18	Upper-contact	XF2L-1825-1□		Lower-contact	XF2L-3035-1□	
9	Upper-contact	XF2L-0925-1□	18	Lower-contact	XF2L-1835-1□	---	---	---	

**Note:** 1. The symbol in the box at the end of the model number indicates the type of plating.

A: Gold-plated (RoHS compliant).

2. Consult your OMRON representative for inquiries related to pin number specifications.
3. Order an integer multiple of the quantity per reel.
4. Consult your OMRON representative for inquiries about lead-free tin solder.
5. Non-RoHS solder plating models (specified by only a “-1” at the end of the model number) ended production in March 2006 and are no longer available.

### Pin Number Specifications

Refer to the following website for the latest information. <http://www.components.omron.com>

# ZIF Slide-locking Connector (0.5-mm Pitch)

# XF2J

## Top-entry ZIF Connector

- Low on-board profile of only 4.15 mm.
- Vacuum contact surface on top of the connector for automatic mounting.
- Models with reverse terminal arrangement also available.
- Applicable FPC thickness of 0.3 mm.



RoHS Compliant

## Ratings and Specifications

XF2J-□□24-1□A

Rated current	0.5 A AC/DC
Rated voltage	50 V AC/DC
Contact resistance	30 mΩ max. (at 20 mV max., 100 mA max.)
Insulation resistance	100 MΩ min. (at 250 V DC)
Withstand voltage	250 V AC for 1 min. (leakage current: 1 mA max.)
Insertion tolerance	30 times
Ambient operating temperature	-30 to 85°C (with no icing or condensation)

## Materials and Finish

XF2J-□□24-1□A

Housing	PA46 resin (UL94V-0)/natural
Slider	PPS resin (UL94V-0)/black LCP resin (UL94V-0)/black
Contacts	Spring copper alloy/nickel substrate (2 μm), gold-plated contacts (0.15 μm)
Hold-down	Spring copper alloy/fused-tin plating (1.5 μm)

## Dimensions

XF2J-□□24-1□□

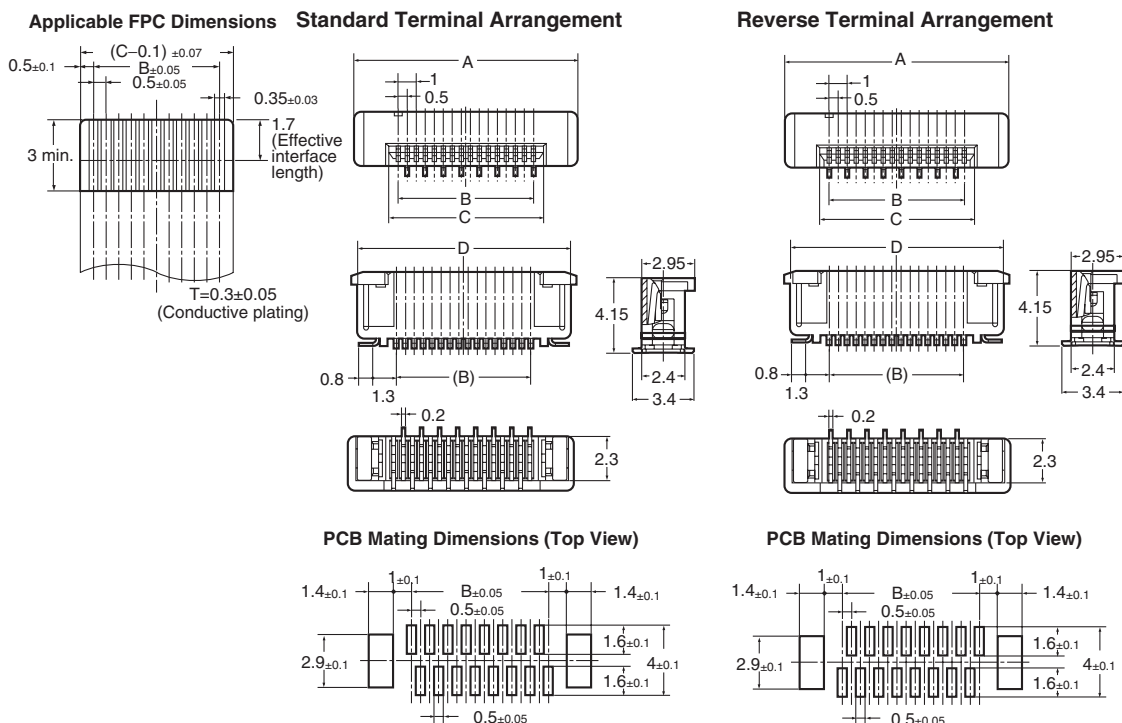
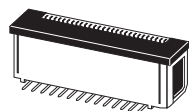

Table of Dimensions

Pins (See note 2.)	Model (See note 1.)		A	B	C	D	Pins (See note 2.)	Model (See note 1.)		A	B	C	D
	Standard Terminal Arrangement	Reverse Terminal Arrangement						Standard Terminal Arrangement	Reverse Terminal Arrangement				
6	XF2J-0624-11□	XF2J-0624-12□	7.5	2.5	3.6	6.9	20	XF2J-2024-11□	XF2J-2024-12□	14.5	9.5	10.6	13.9
8	XF2J-0824-11□	XF2J-0824-12□	8.5	3.5	4.6	7.9	22	XF2J-2224-11□	XF2J-2224-12□	15.5	10.5	11.6	14.9
10	XF2J-1024-11□	XF2J-1024-12□	9.5	4.5	5.6	8.9	24	XF2J-2424-11□	XF2J-2424-12□	16.5	11.5	12.6	15.9
12	XF2J-1224-11□	XF2J-1224-12□	10.5	5.5	6.6	9.9	26	XF2J-2624-11□	---	17.5	12.5	13.6	16.9
14	XF2J-1424-11□	---	11.5	6.5	7.6	10.9	28	XF2J-2824-11□	---	18.5	13.5	14.6	17.9
16	XF2J-1624-11□	XF2J-1624-12□	12.5	7.5	8.6	11.9	30	XF2J-3024-11□	---	19.5	14.5	15.6	18.9
18	XF2J-1824-11□	XF2J-1824-12□	13.5	8.5	9.6	12.9	---	---	---	---	---	---	---

## ■ Ordering Information

Pins (See note 2.)	Model (See note 1.)		Quantity per reel (See note 3.)
	Standard Terminal Arrangement	Reverse Terminal Arrangement	
6	XF2J-0624-11□	XF2J-0624-12□	1,000
8	XF2J-0824-11□	XF2J-0824-12□	
10	XF2J-1024-11□	XF2J-1024-12□	
12	XF2J-1224-11□	XF2J-1224-12□	
14	XF2J-1424-11□	---	
16	XF2J-1624-11□	XF2J-1624-12□	
18	XF2J-1824-11□	XF2J-1824-12□	
20	XF2J-2024-11□	XF2J-2024-12□	
22	XF2J-2224-11□	XF2J-2224-12□	
24	XF2J-2424-11□	XF2J-2424-12□	
26	XF2J-2624-11□	---	
28	XF2J-2824-11□	---	
30	XF2J-3024-11□	---	

- Note:**
1. The symbol in the box at the end of the model number indicates the type of plating.  
A: Gold-plated (RoHS compliant).
  2. Consult your OMRON representative for inquiries related to pin number specifications.
  3. Order an integer multiple of the quantity per reel.
  4. Consult your OMRON representative for inquiries about lead-free tin solder.
  5. Non-RoHS solder plating models (specified by only a “-1” at the end of the model number) ended production in March 2006 and are no longer available.

### Pin Number Specifications

Refer to the following website for the latest information. <http://www.components.omron.com>

# Common Precautions for XF Connectors

## ■ Safety Precautions

### Precautions for Correct Use

#### ● All Models

#### Operating

- Make sure that the FPC has been inserted correctly and not backward.  
Inserting the FPC incorrectly with the FPC connecting face not aligned with the customer's design specifications may damage the contacts and equipment may malfunction.
- Insert the FPC fully to the back of the connector. Failing to do so may result in a loss of contact reliability.
- When inserting and removing the FPC, applying pressure from above or below, left to right or at an angle may cause the FPC contacts to become damaged or detached and may result in contact failure.

#### Designing

- Gently pull out the FPC taking care not to apply force directly to the connector.  
Bending the FPC in the area where it enters the connector or applying force to the FPC itself may result in contact failure.
- When installing the FPC at a location or on equipment that will subject the FPC to repeated vibration or movement, secure the FPC prior to use.
- Use FPCs that conform to the appropriate specifications and size as stated by OMRON.  
When using a different FPC, or an F/F, contact OMRON.
- Use the same metal for the FPC plating and the connector plating.
- "Whiskers" may protrude from the FPC film of some lead-free FPCs. Be careful when using these units.
- Ensure a metal mask thickness of  $t = 0.12$  to  $0.15$  mm.  
The recommended metal mask open area is 90% of the printed circuit board mating dimensions given in the dimensions diagrams.

#### Mounting

- Do not perform mounting (reflow or manual soldering) with the FPC inserted in the connector. Doing so may result in contact failure.
- The reflow conditions are as stated in OMRON's specifications and guidelines. These conditions, however, depend on the type of solder, the manufacturer, the amount of solder, the size of the circuit board, and the other mounting materials. Confirm the mounting conditions before using the connectors.
- When mounting the connector by manual soldering, observe the following precautions to ensure contact reliability.
  1. Conditions for manual soldering:  $350 \pm 10^\circ\text{C}$  for  $3 \pm 1$  seconds
  2. Do not apply an excessive amount of solder. Excessive solder will cause the flux to rise.
  3. Do not apply the soldering iron to the mount attachments using force. Doing so may cause the connectors to change shape.
  4. Do not apply the soldering iron to any parts of the connector other than the mount attachments. Doing so may cause the connector to change shape.

#### Board Mounting Precautions

- Be careful of board warping. The connector flatness is 0.1 mm max. A large amount of warping, however, may result in soldering faults.
- Do not apply excessive force on the connector before mounting it. The connector may be damaged, resulting in faulty contacts. Do not insert the FPC and lock the slider before mounting the connector.
- Avoid applying excessive force on the board when performing the following actions:
  1. Dividing multi-cavity boards.
  2. Securing a board with screws.

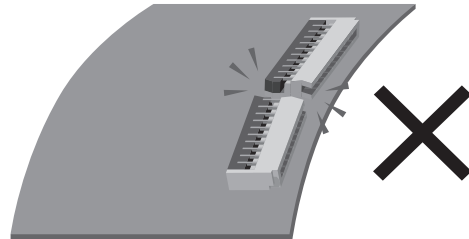

#### Storage

1. Do not store the connectors in locations subject to dust or high humidity.
2. Do not store the connectors in locations close to sources of gasses such ammonia gas or sulfide gas.

**● All Models****Operating**

- Do not lock or unlock the slider with excessive force. Doing so may result in damage to the connector or contact failure.
- Do not use the slider again if it becomes detached.
- When inserting and removing the FPC, be sure to check that the slider has been unlocked first. Using the FPC in the follow ways may damage the FPC, change the shape of the contacts, or result in contact failure.
  1. Removing the FPC when the slider is still locked.
  2. Removing the FPC by pulling it up and down or from left to right or twisting it sideways.

**● Backlocking Models****Operating**

- Do not lock the slider without an FPC inserted. Locking the slider without an FPC inserted will cause a decrease in the dimensions between the contacts and consequently an increase in the force required to insert an FPC.
- When locking the slider, apply pressure with your fingertips to both sides of the slider, then twist the slider until it comes away from the unit. Failing to lock the slider properly may result in contact failure.
- Do not apply force horizontally to the PCB when locking the slider. Doing so may result in damage to the connector or contact failure.
- When unlocking the slider, place your fingers on either side or on the entire slider and slowly lift the slider up and away. Do not engage the slider past its initial location during the unlocking process. Doing so may result in damage to the connector or contact failure.

**Designing**

- When designing the board, be sure to allow locking and operating space for the slider.

**Mounting**

- Do not perform reflow or manual soldering with the FPC inserted in the connector and the slider in the locked position. Doing so may result in contact failure.

**● Frontlocking Models****Operating**

- When unlocking the slider, use your fingernail to rotate and lift the slider. The slider cannot be opened to an angle of more than 125°. Do not apply force on the slider beyond that point. Doing so may result in damage to the connector or contact failure. When locking the slider, apply pressure with your fingertips to the center of the slider, then twist the slider until it comes away from the unit. Failing to lock the slider properly may result in contact failure.

**● Slidelocking Models****Operating**

- When locking the slider, apply pressure to both sides or the entire slider, then push the slider all the way in. Not doing so may result in contact failure.

**Designing**

- When designing the board, be sure to allow unlocking and operating space for the slider.

# Operating the XF Rotary Backlock

## FPC Connector Part Names

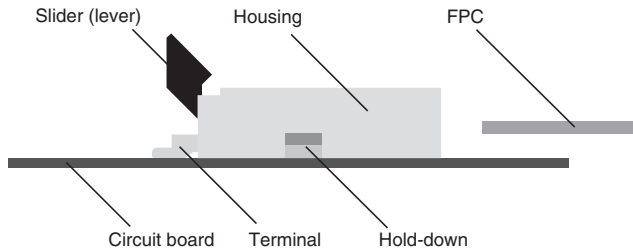

## Handling Methods

### Inserting the FPC

1. Insert the FPC all the way to the back of the connector.

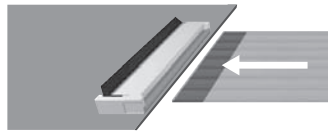

The slider (lever) shown open



2. Activate the slider (lever) and lock the FPC in place.

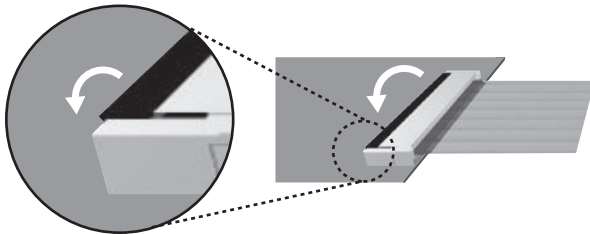

The slider (lever) shown locked

### Removing the FPC

1. Move the slider (lever) upwards to disengage the locking mechanism.

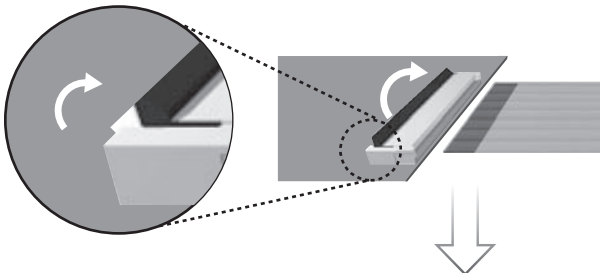

2. Once the lock has been disengaged, pull the FPC out.

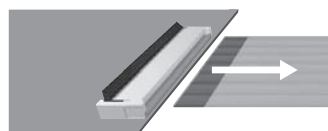

## Precautions during Use

### Operating

1. Do not lock the slider (lever) without an FPC inserted. Locking the slider (lever) without an FPC inserted will increase the force required to insert an FPC.

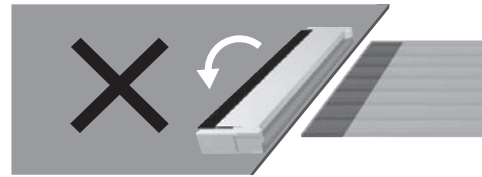
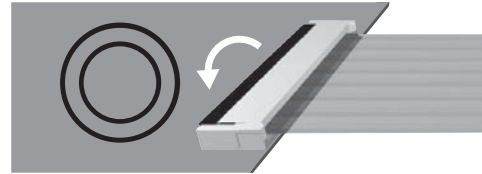

2. Do not lock or unlock the slider (lever) with excessive force. Doing so may result in damage to the connector or contact failure. Do not use a slider (lever) if it becomes detached.
3. When locking the slider (lever), apply pressure with your fingertips to both sides of the slider (lever) and then twist the slider (lever) until it comes away from the unit. Failing to lock the slider (lever) properly may result in contact failure.

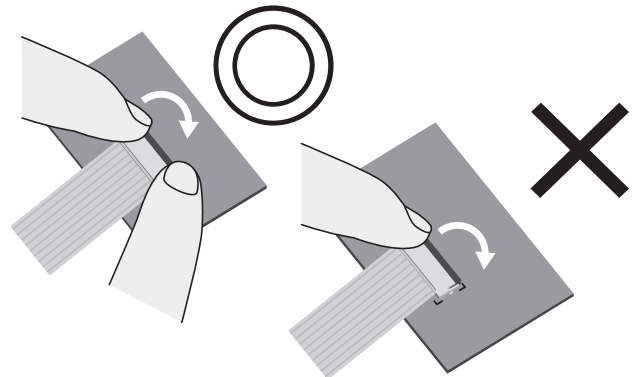

Do not apply force horizontally to the PCB when locking the slider (lever). Doing so may result in damage to the connector or contact failure.

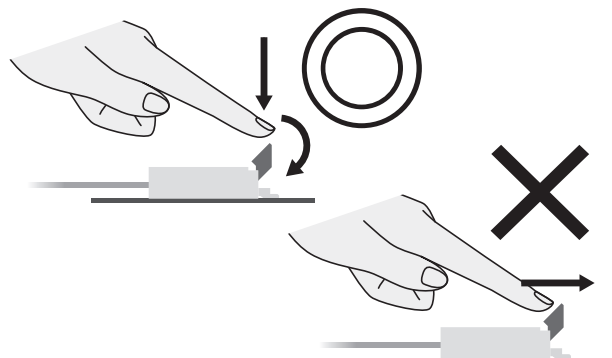

4. When unlocking the slider (lever), place your fingers on either side or the entire slider (lever) and slowly lift the slider (lever) up and away.

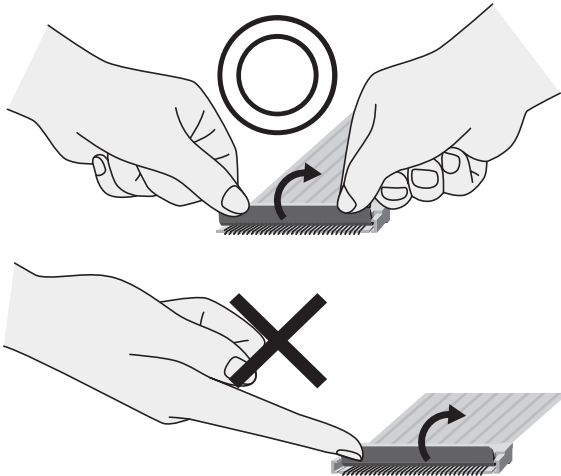

Do not engage the slider (lever) past its initial location during the unlocking process. Doing so may result in damage to the connector or contact failure.

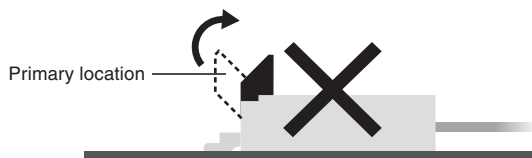

Performing the following action may cause the terminals to change shape or otherwise cause contact failures.

- Using tweezers to unlock the slider (lever).

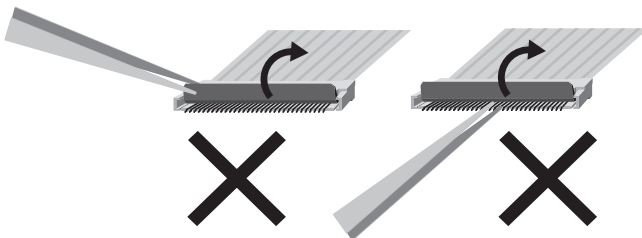

5. When inserting and removing the FPC, be sure to check that the slider (lever) has been unlocked first.

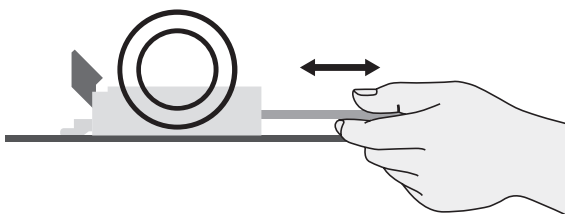

Using the FPC in the follow ways may damage the FPC, change the shape of the contacts, or result in contact failure.

- Removing the FPC when the slider (lever) is still locked.

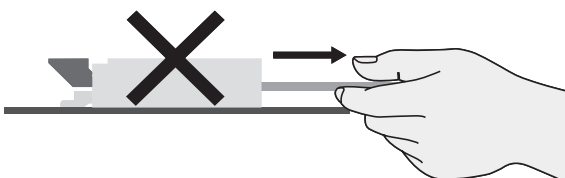

- Removing the FPC by pulling it up and down or from left to right or twisting it sideways.

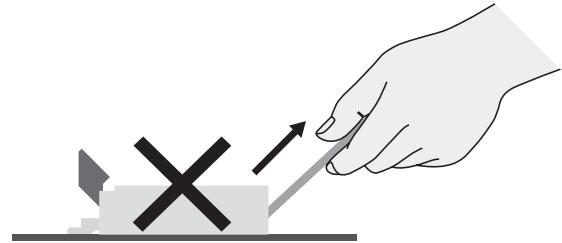

6. Make sure that the FPC has been inserted correctly and not backward.  
Inserting the FPC incorrectly with the connecting face not aligned with the customer's design specification may damage the contacts and equipment may malfunction.

#### Mounting

1. Do not perform reflow or manual soldering with the FPC inserted in the connector and the slider (lever) in the locked position. Doing so may result in contact failure.
2. The reflow conditions are as stated in OMRON's specifications and guidelines. These conditions, however, depend on the type of solder, the size of the circuit board, and the other mounting materials. Confirm the mounting conditions before proceeding.

#### Designing

1. Gently pull out the FPC taking care not to apply force directly to the connector. Bending the FPC in the area where it enters the connector or applying force to the FPC itself may result in contact failure.
2. When installing the FPC at a location or on equipment that will subject the FPC to repeated vibration or movement, secure the FPC prior to use.
3. Use the FPCs that conform to the appropriate specifications and size as stated by OMRON. When using a different FPC, or an F/F, contact OMRON.
4. Use the same metal for the FPC plating and the connector plating.
5. "Whiskers" may protrude from the FOC film of some lead-free FPCs. Be careful when using these units.
6. When designing the board, be sure to allow locking and operating space for the slider (lever).

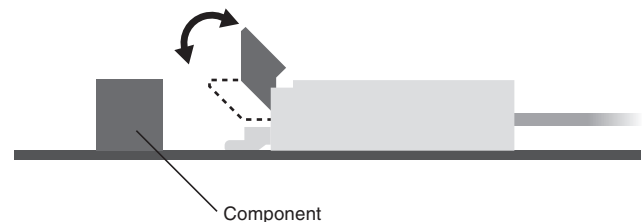

7. Make sure that the metal mask thickness is within the appropriate specifications and size as stated by OMRON. The recommended metal mask open area is 90% of the printed circuit board mating dimensions given in the dimensions diagrams.



# Operating the XF Rotary Front Lock

## FPC Connector Part Names

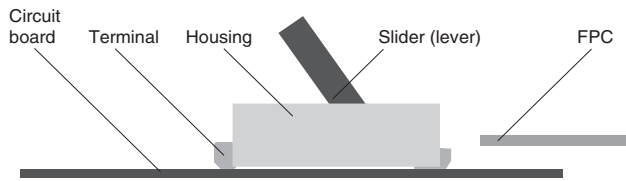

## Handling Methods

### Inserting the FPC

1. Use your fingernail on the center of the slider to twist the slider until it comes away from the unit.

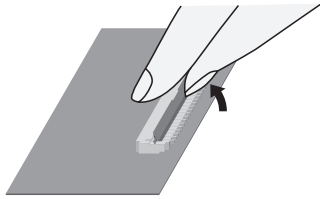

2. Securely insert the FPC so that it is perpendicular to the connector and horizontal to the connector.



3. When locking the slider, apply pressure with your fingertips to the center of the slider, then twist the slider until it comes away from the unit.

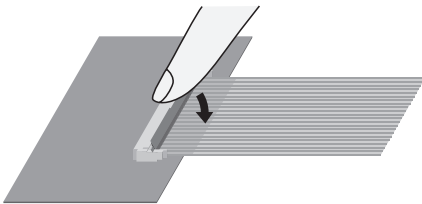

### Removing the FPC

1. Unlock the slider by pushing it up, then remove the FPC.

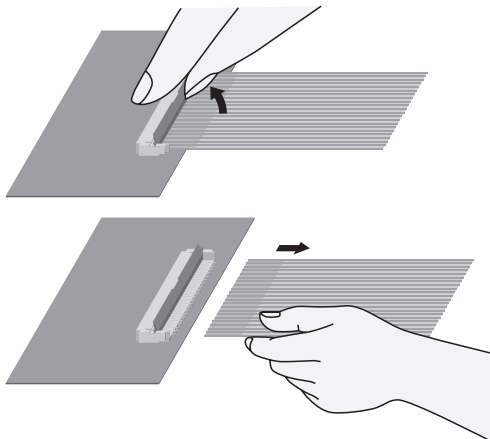

## Precautions during Use

### Operating

1. The slider mechanism rotates around a rotary shaft. Operate the slider in a rotating movement.

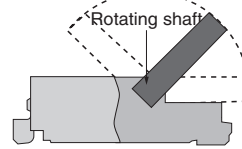

2. The slider cannot be opened to an angle of more than 125°. Do not apply force on the slider beyond that point. Doing so may result in damage to the connector or contact failure. Do not use the slider if it becomes detached.

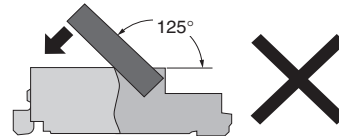

3. Lock and unlock the slider using the center of the slider. Using the end of the slider may result in incomplete locking, damage, or contact failure.
4. As shown in the following figure, do not touch the terminals with your fingernail or fingers if using the slider without the FPC inserted. Doing so may cause the terminals to change shape and result in contact failure.

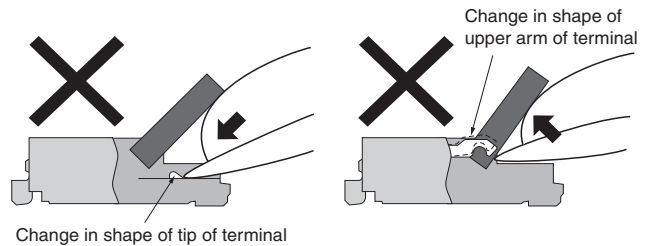

5. Using the FPC in the follow ways may damage the FPC, change the shape of the contacts, or result in contact failure.

- Removing the FPC when the slider (lever) is still locked.

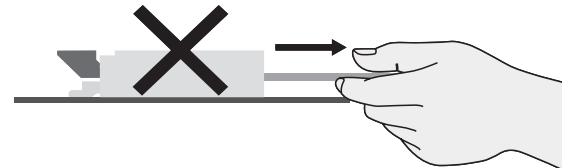

- Removing the FPC by pulling it up and down or from left to right or twisting it sideways.

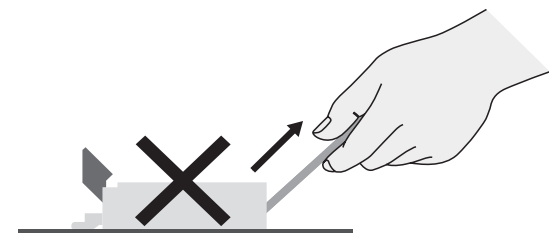

6. Make sure that the FPC has been inserted correctly and not backward. Inserting the FPC incorrectly with the connecting face not aligned with the customer's design specification may damage the contacts and equipment may malfunction.

### Mounting

1. Do not perform reflow or manual soldering with the FPC inserted in the connector and the slider (lever) in the locked position. Doing so may result in contact failure.
2. The reflow conditions are as stated in OMRON's specifications and guidelines. These conditions, however, depend on the type of solder, the manufacturer, the amount of solder, the size of the circuit board, and the other mounting materials. Confirm the mounting conditions before proceeding.

### Designing

1. Gently pull out the FPC taking care not to apply force directly to the connector. Bending the FPC in the area where it enters the connector or applying force to the FPC itself may result in contact failure.
2. When installing the FPC at a location or on equipment that will subject the FPC to repeated vibration or movement, secure the FPC prior to use.
3. Use the FPCs that conform to the appropriate specifications and size as stated by OMRON. When using a different FPC, or an F/F, contact OMRON.
4. Use the same metal for the FPC plating and the connector plating.
5. "Whiskers" may protrude from the FPC film of some lead-free FPCs. Be careful when using these units.
6. Make sure that the metal mask thickness is within the appropriate specifications and size as stated by OMRON. The recommended metal mask open area is 90% of the printed circuit board mating dimensions given in the dimensions diagrams.

## Lead-Free Solder

To comply with the prohibition of lead use stipulated by the RoHS Directive, SnPb solder plating FPC connectors must be lead free. OMRON implemented the plan to end production of solder plating as of March 2006. Instead of solder plating (SnPb) connectors, OMRON is providing reflow (Sn) plating connectors\* with whisker prevention and Gold (Au) plating connectors.

\* Applicable Models

XF2M-□□15-1L

XF2L-□□□5-1

XF2J-□□24-1□

### Precautions

- "Whiskers" may occur on the FPC film when using lead-free solder. Check for "whiskers" before using the connectors.
- Use the same metal for the FPC plating and the connector plating. Using more than one type of metal may cause corrosion.

For more information, contact your OMRON sales representative.

**ALL DIMENSIONS SHOWN ARE IN MILLIMETERS.**

To convert millimeters into inches, multiply by 0.03937. To convert grams into ounces, multiply by 0.03527.

# Terms and Conditions of Sales

1. **Definitions:** The words used herein are defined as follows.
  - (a) **Terms:** These terms and conditions
  - (b) **Seller:** Omron Electronic Components LLC and its subsidiaries
  - (c) **Buyer:** The buyer of Products, including any end user in section III through VI
  - (d) **Products:** Products and/or services of Seller
  - (e) **Including:** Including without limitation
2. **Offer/Acceptance:** These Terms are deemed part of all quotations, acknowledgments, invoices, purchase orders and other documents, whether electronic or in writing, relating to the sale of Products by Seller. Seller hereby objects to any Terms proposed in Buyer's purchase order or other documents which are inconsistent with, or in addition to, these Terms.
3. **Distributor:** Any distributor shall inform its customer of the contents after and including section III of these Terms.
1. **Prices/Payment:** All prices stated are current, subject to change without notice by Seller. Buyer agrees to pay the price in effect at time of shipment. Payments for Products received are due net 30 days unless otherwise stated in the invoice. Buyer shall have no right to set off any amounts against the amount owing in respect of this invoice.
2. **Discounts:** Cash discounts, if any, will apply only on the net amount of invoices sent to Buyer after deducting transportation charges, taxes and duties, and will be allowed only if (a) the invoice is paid according to Seller's payment terms and (b) Buyer has no past due amounts owing to Seller.
3. **Interest:** Seller, at its option, may charge Buyer 1.5% interest per month or the maximum legal rate, whichever is less, on any balance not paid within the stated terms.
4. **Orders:** Seller will accept no order less than 200 U.S. dollars net billing.
5. **Currencies:** If the prices quoted herein are in a currency other than U.S. dollars, Buyer shall make remittance to Seller at the then current exchange rate most favorable to Seller; provided that if remittance is not made when due, Buyer will convert the amount to U.S. dollars at the then current exchange rate most favorable to Seller available during the period between the due date and the date remittance is actually made.
6. **Governmental Approvals:** Buyer shall be responsible for all costs involved in obtaining any government approvals regarding the importation or sale of the Products.
7. **Taxes:** All taxes, duties and other governmental charges (other than general real property and income taxes), including any interest or penalties thereon, imposed directly or indirectly on Seller or required to be collected directly or indirectly by Seller for the manufacture, production, sale, delivery, importation, consumption or use of the Products sold hereunder (including customs duties and sales, excise, use, turnover and license taxes) shall be charged to and remitted by Buyer to Seller.
8. **Financial:** If the financial position of Buyer at any time becomes unsatisfactory to Seller, Seller reserves the right to stop shipments or require satisfactory security or payment in advance. If Buyer fails to make payment or otherwise comply with these Terms or any related agreement, Seller may (without liability and in addition to other remedies) cancel any unshipped portion of Products sold hereunder and stop any Products in transit until Buyer pays all amounts, including amounts payable hereunder, whether or not then due, which are owing to it by Buyer. Buyer shall in any event remain liable for all unpaid accounts.
9. **Cancellation; Etc:** Orders are not subject to rescheduling or cancellation unless Buyer indemnifies Seller fully against all costs or expenses arising in connection therewith.
10. **Force Majeure:** Seller shall not be liable for any delay or failure in delivery resulting from causes beyond its control, including earthquakes, fires, floods, strikes or other labor disputes, shortage of labor or materials, accidents to machinery, acts of sabotage, riots, delay in or lack of transportation or the requirements of any government authority.
11. **Shipping/Delivery:** Unless otherwise expressly agreed in writing by Seller:
  - (a) All sales and shipments of Products shall be FOB shipping point (unless otherwise stated in writing by Seller), at which point title to and all risk of loss of the Products shall pass from Seller to Buyer, provided that Seller shall retain a security interest in the Products until the full purchase price is paid by Buyer;
  - (b) Delivery and shipping dates are estimates only; and
  - (c) Seller will package Products as it deems proper for protection against normal handling and extra charges apply to special conditions.
12. **Claims:** Any claim by Buyer against Seller for shortage or damage to the Products occurring before delivery to the carrier must be presented in detail in writing to Seller within 30 days of receipt of shipment.
1. **Suitability:** IT IS THE BUYER'S SOLE RESPONSIBILITY TO ENSURE THAT ANY OMRON PRODUCT IS FIT AND SUFFICIENT FOR USE IN A MOTORIZED VEHICLE APPLICATION. BUYER SHALL BE SOLELY RESPONSIBLE FOR DETERMINING APPROPRIATENESS OF THE PARTICULAR PRODUCT WITH RESPECT TO THE BUYER'S APPLICATION INCLUDING (A) ELECTRICAL OR ELECTRONIC COMPONENTS, (B) CIRCUITS, (C) SYSTEM ASSEMBLIES, (D) END PRODUCT, (E) SYSTEM, (F) MATERIALS OR SUBSTANCES OR (G) OPERATING ENVIRONMENT. Buyer acknowledges that it alone has determined that the Products will meet their requirements of the intended use in all cases. Buyer must know and observe all prohibitions of use applicable to the Products.
2. **Use with Attention:** The followings are some examples of applications for which particular attention must be given. This is not intended to be an exhaustive list of all possible use of any Product, nor to imply that any use listed may be suitable for any Product:
  - (a) Outdoor use, use involving potential chemical contamination or electrical interference.
  - (b) Use in consumer Products or any use in significant quantities.
  - (c) Energy control systems, combustion systems, railroad systems, aviation systems, medical equipment, amusement machines, vehicles, safety equipment, and installations subject to separate industry or government regulations.
  - (d) Systems, machines, and equipment that could present a risk to life or property.
3. **Prohibited Use:** NEVER USE THE PRODUCT FOR AN APPLICATION INVOLVING SERIOUS RISK TO LIFE OR PROPERTY WITHOUT ENSURING THAT THE SYSTEM AS A WHOLE HAS BEEN DESIGNED TO ADDRESS THE RISKS, AND THAT THE PRODUCT IS PROPERLY RATED AND INSTALLED FOR THE INTENDED USE WITHIN THE OVERALL EQUIPMENT OR SYSTEM.
4. **Motorized Vehicle Application:** USE OF ANY PRODUCT/S FOR A MOTORIZED VEHICLE APPLICATION MUST BE EXPRESSLY STATED IN THE SPECIFICATION BY SELLER.
5. **Programmable Products:** Seller shall not be responsible for the Buyer's programming of a programmable Product.
1. **Warranty:** Seller's exclusive warranty is that the Products will be free from defects in materials and workmanship for a period of twelve months from the date of sale by Seller (or such other period expressed in writing by Seller). SELLER MAKES NO WARRANTY OR REPRESENTATION, EXPRESS OR IMPLIED, ABOUT ALL OTHER WARRANTIES, NON-INFRINGEMENT, MERCHANTABILITY OR FITNESS FOR A PARTICULAR PURPOSE OF THE PRODUCTS.
2. **Buyer Remedy:** Seller's sole obligation hereunder shall be to replace (in the form originally shipped with Buyer responsible for labor charges for removal or replacement thereof) the non-complying Product or, at Seller's election, to repay or credit Buyer an amount equal to the purchase price of the Product; provided that there shall be no liability for Seller or its affiliates unless Seller's analysis confirms that the Products were handled, stored, installed and maintained and not subject to contamination, abuse, misuse or inappropriate modification. Return of any Products by Buyer must be approved in writing by Seller before shipment.
3. **Limitation on Liability:** SELLER AND ITS AFFILIATES SHALL NOT BE LIABLE FOR SPECIAL, INDIRECT, INCIDENTAL OR CONSEQUENTIAL DAMAGES, LOSS OF PROFITS OR PRODUCTION OR COMMERCIAL LOSS IN ANY WAY CONNECTED WITH THE PRODUCTS, WHETHER SUCH CLAIM IS BASED IN CONTRACT, WARRANTY, NEGLIGENCE OR STRICT LIABILITY. FURTHER, IN NO EVENT SHALL LIABILITY OF SELLER OR ITS AFFILIATES EXCEED THE INDIVIDUAL PRICE OF THE PRODUCT ON WHICH LIABILITY IS ASSERTED.
4. **Indemnities:** Buyer shall indemnify and hold harmless Seller, its affiliates and its employees from and against all liabilities, losses, claims, costs and expenses (including attorney's fees and expenses) related to any claim, investigation, litigation or proceeding (whether or not Seller is a party) which arises or is alleged to arise from Buyer's acts or omissions under these Terms or in any way with respect to the Products.
1. **Intellectual Property:** The intellectual property embodied in the Products is the exclusive property of Seller and its affiliates and Buyer shall not attempt to duplicate it in any way without the written permission of Seller. Buyer (at its own expense) shall indemnify and hold harmless Seller and defend or settle any action brought against Seller to the extent that it is based on a claim that any Product made to Buyer specifications infringed intellectual property rights of another party.
2. **Property/Confidentiality:** Notwithstanding any charges to Buyer for engineering or tooling, all engineering and tooling shall remain the exclusive property of Seller. All information and materials supplied by Seller to Buyer relating to the Products are confidential and proprietary, and Buyer shall limit distribution thereof to its trusted employees and strictly prevent disclosure to any third party.
3. **Performance Data:** Performance data is provided as a guide in determining suitability and does not constitute a warranty. It may represent the result of Seller's test conditions, and the users must correlate it to actual application requirements.
4. **Change In Specifications:** Product specifications and description may be changed at any time based on improvements or other reasons. It is Seller's practice to change part numbers when published ratings or features are changed, or when significant engineering changes are made. However, some specifications of the Product may be changed without any notice.
5. **Errors And Omissions:** The information on Seller's website or in other documentation has been carefully checked and is believed to be accurate; however, no responsibility is assumed for clerical, typographical or proofreading errors or omissions.
6. **Export Controls:** Buyer shall comply with all applicable laws, regulations and licenses regarding (a) export of the Products or information provided by Seller; (b) sale of Products to forbidden or other proscribed persons or organizations; (c) disclosure to non-citizens of regulated technology or information.
1. **Waiver:** No failure or delay by Seller in exercising any right and no course of dealing between Buyer and Seller shall operate as a waiver of rights by Seller.
2. **Assignment:** Buyer may not assign its rights hereunder without Seller's written consent.
3. **Law:** These Terms are governed by Illinois law (without regard to conflict of laws). Federal and state courts in Illinois have exclusive jurisdiction for any dispute hereunder.
4. **Amendment:** These Terms constitute the entire agreement between Buyer and Seller relating to the Products, and no provision may be changed or waived unless in writing signed by the parties.
5. **Severability:** If any provision hereof is rendered ineffective or invalid, such provision shall not invalidate any other provision.

## Omron Electronic Components: The Quality, Flexibility and Global Support You Need

### For More Detailed Information...

#### Visit Us Online: [www.components.omron.com](http://www.components.omron.com)

- Browse Omron's full range of Product information and selection guides.
- Search the cross-reference database to locate Omron component solutions.
- Download PDF data sheets, brochures and more.
- Locate a Distributor and search for available inventory.
- Complete Terms and Conditions of Sale and Usage.

#### Call Us:

1-847-882-2288 Monday through Friday,  
7:30 a.m. to 6:00 p.m. Central Time (CT)

#### Email Us:

[components@omron.com](mailto:components@omron.com)

#### OMRON ELECTRONIC COMPONENTS LLC

55 Commerce Drive • Schaumburg, IL 60173



G011-E-06A  
© 2007 Omron Electronic Components, Printed in the U.S.A.  
5/2007

[www.components.omron.com](http://www.components.omron.com)

**OMRON**<sup>®</sup>  
ELECTRONIC COMPONENTS