

# Digital Control Compatible Dual Low-Side $\pm 4$ Amp MOSFET Drivers with Programmable Common Current Sense

Check for Samples: [UCD7201](#)

## FEATURES

- Adjustable Current Limit Protection
- 3.3-V, 10-mA Internal Regulator
- DSP/ $\mu$ C Compatible Inputs
- Dual  $\pm 4$ -A TrueDrive™ High Current Drivers
- 10-ns Typical Rise and Fall Times with 2.2-nF Loads
- 20-ns Input-to-Output Propagation Delay
- 25-ns Current Sense-to-Output Propagation Delay
- Programmable Current Limit Threshold
- Digital Output Current Limit Flag
- 4.5-V to 15-V Supply Voltage Range
- Rated from  $-40^{\circ}\text{C}$  to  $105^{\circ}\text{C}$

## APPLICATIONS

- Digitally Controlled Power Supplies
- DC/DC Converters
- Motor Controllers
- Line Drivers

## DESCRIPTION

The UCD7201 is a member of the UCD7K family of digital control compatible drivers for applications utilizing digital control techniques or applications requiring fast local peak current limit protection.

The UCD7201 includes dual low-side  $\pm 4$ -A high-current MOSFET gate drivers. It allows the digital power controllers such as UCD9110 or UCD9501 to interface to the power stage in double ended topologies. It provides a cycle-by-cycle current limit function for both driver channels, a programmable threshold and a digital output current limit flag which can be monitored by the host controller. With a fast cycle-by-cycle current limit protection, the driver can turn off the power stage in the event of an overcurrent condition.

For fast switching speeds, the UCD7201 output stages use the TrueDrive™ output architecture, which delivers rated current of  $\pm 4$  A into the gate of a MOSFET during the Miller plateau region of the switching transition. It also includes a 3.3-V, 10-mA linear regulator to provide power to the digital controller.

## TYPICAL APPLICATION DIAGRAM (Push-Pull Converter)

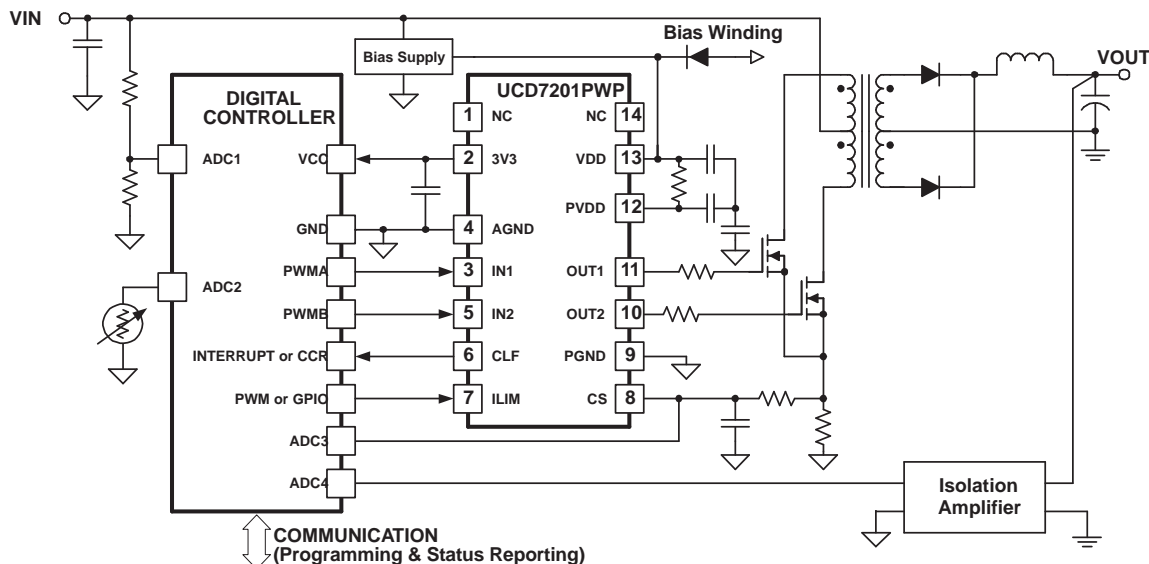

Please be aware that an important notice concerning availability, standard warranty, and use in critical applications of Texas Instruments semiconductor products and disclaimers thereto appears at the end of this data sheet.

TrueDrive, PowerPAD are trademarks of Texas Instruments.



These devices have limited built-in ESD protection. The leads should be shorted together or the device placed in conductive foam during storage or handling to prevent electrostatic damage to the MOS gates.

## DESCRIPTION (CONT.)

For similar applications requiring direct start-up capability from higher voltages such as the 48-V telecom input line, the UCD7601 includes a 110-V high-voltage startup circuit.

The UCD7K driver family is compatible with standard 3.3-V I/O ports of DSPs, Microcontrollers, or ASICs. UCD7201 is offered in a PowerPAD™ HTSSOP-14 package.

## CONNECTION DIAGRAMS

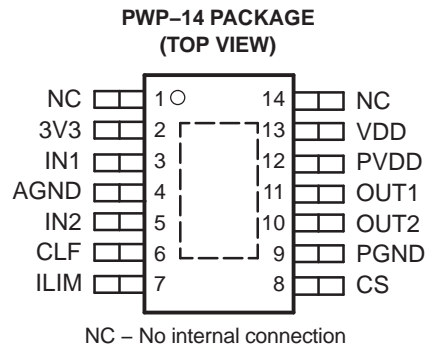

## ORDERING INFORMATION

TEMPERATURE RANGE	CURRENT SENSE LIMIT PER CHANNEL	110-V HV STARTUP CIRCUIT	PACKAGED DEVICES
			PowerPAD™ HTSSOP-14 (PWP) <sup>(1)</sup>
-40°C to 105°C	Common	No	UCD7201PWP

(1) HTSSOP-14 (PWP) package is available taped and reeled. Add R suffix to device type (e.g. UCD7201PWPR) to order quantities of 2,000 devices per reel for the PWP package.

## PACKAGING INFORMATION

PACKAGE	SUFFIX	$\theta_{JC}$ (°C/W)	$\theta_{JA}$ (°C/W)	POWER RATING $T_A = 70^\circ\text{C}$ , $T_J = 125^\circ\text{C}$ (mW)	DERATING FACTOR, ABOVE 70°C (mW/°C)
PowerPAD™ HTSSOP- 14	PWP	2.07	37.47 <sup>(1)</sup>	1470	27

(1) PowerPAD™ soldered to the PWB (TI recommended PWB as defined in TI's application report SLMA002 pg.33) with OLFM.

**ABSOLUTE MAXIMUM RATINGS<sup>(1) (2)</sup>**

SYMBOL	PARAMETER		UCD7201	UNIT
V <sub>DD</sub>	Supply Voltage		16	V
I <sub>DD</sub>	Supply Current	Quiescent	20	mA
		Switching, T <sub>A</sub> = 25°C, , T <sub>J</sub> = 125°C, V <sub>DD</sub> = 12 V	200	
V <sub>OUT</sub>	Output Gate Drive Voltage	OUT	-1 to PVDD	V
I <sub>OUT(sink)</sub>	Output Gate Drive Current	OUT	4.0	A
I <sub>OUT(source)</sub>			-4.0	
	Analog Input	ISET, CS	-0.3 to 3.6	V
		ILIM	-0.3 to 3.6	
	Digital I/O's	IN, CLF	-0.3 to 3.6	
	Power Dissipation	T <sub>A</sub> = 25°C (PWP-14 package), T <sub>J</sub> = 125°C	2.67	W
T <sub>J</sub>	Junction Operating Temperature	UCD7201	-55 to 150	°C
T <sub>str</sub>	Storage Temperature		-65 to 150	
HBM	ESD Rating	Human body model	2000	V
CDM		Change device model	500	

- (1) Stresses beyond those listed under “absolute maximum ratings” may cause permanent damage to the device. These are stress ratings only, and functional operation of the device at these or any other conditions beyond those indicated under “recommended operating conditions” is not implied. Exposure to absolute-maximum-rated conditions for extended periods may affect device reliability.
- (2) All voltages are with respect to GND. Currents are positive into, negative out of the specified terminal.

**ELECTRICAL CHARACTERISTICS**

V<sub>DD</sub> = 12 V, 4.7-μF capacitor from V<sub>DD</sub> to GND, 0.22μF from 3V3 to AGND, T<sub>A</sub> = T<sub>J</sub> = -40°C to 105°C, (unless otherwise noted).

PARAMETER	TEST CONDITIONS	MIN	TYP	MAX	UNIT
<b>SUPPLY SECTION</b>					
Supply current, OFF	V <sub>DD</sub> = 4.2 V	-	200	400	μA
Supply current	Outputs not switching IN = LOW	-	1.5	2.5	mA
<b>LOW VOLTAGE UNDER-VOLTAGE LOCKOUT</b>					
VDD UVLO ON		4.25	4.5	4.75	V
VDD UVLO OFF		4.05	4.25	4.45	
VDD UVLO hysteresis		150	250	350	mV
<b>REFERENCE / EXTERNAL BIAS SUPPLY</b>					
3V3 initial set point	T <sub>A</sub> = 25°C, I <sub>LOAD</sub> = 0	3.267	3.3	3.333	V
3V3 set point over temperature		3.234	3.3	3.366	
3V3 load regulation	I <sub>LOAD</sub> = 1 mA to 10 mA, VDD = 5 V	-	1	6.6	mV
3V3 line regulation	VDD = 4.75 V to 12 V, I <sub>LOAD</sub> = 10 mA	-	1	6.6	
Short circuit current	VDD = 4.75 to 12 V	11	20	35	mA
3V3 OK threshold, ON	3.3 V rising	2.9	3.0	3.1	V
3V3 OK threshold, OFF	3.3 V falling	2.7	2.8	2.9	
<b>INPUT SIGNAL</b>					
HIGH, positive-going input threshold voltage (VIT+)		1.65	-	2.08	V
LOW negative-going input threshold voltage (VIT-)		1.16	-	1.5	
Input voltage hysteresis, (VIT+ - VIT-)		0.6	-	0.8	
Frequency		-	-	2	MHz

**ELECTRICAL CHARACTERISTICS (continued)**

$V_{DD} = 12\text{ V}$ , 4.7- $\mu\text{F}$  capacitor from  $V_{DD}$  to GND, 0.22 $\mu\text{F}$  from 3V3 to AGND,  $T_A = T_J = -40^\circ\text{C}$  to  $105^\circ\text{C}$ , (unless otherwise noted).

PARAMETER	TEST CONDITIONS	MIN	TYP	MAX	UNIT
<b>CURRENT LIMIT (ILIM)</b>					
ILIM internal current limit threshold	$I_{LIM} = \text{OPEN}$	0.51	0.55	0.58	V
ILIM maximum current limit threshold	$I_{LIM} = 3.3\text{ V}$	1.05	1.10	1.15	
ILIM current limit threshold	$I_{LIM} = 0.75\text{ V}$	0.700	0.725	0.750	
ILIM minimum current limit threshold	$I_{LIM} = 0.25\text{ V}$	0.21	0.23	0.25	
CLF output high level	$CS > I_{LIM}$ , $I_{LOAD} = -7\text{ mA}$	2.64	-	-	
CLF output low level	$CS \leq I_{LIM}$ , $I_{LOAD} = 7\text{ mA}$	-	-	0.66	
Propagation delay from IN to CLF	IN rising to CLF falling after a current limit event	-	10	20	ns
<b>CURRENT SENSE COMPARATOR</b>					
Bias voltage	Includes CS comp offset	5	25	50	mV
Input bias current		-	-1	-	$\mu\text{A}$
Propagation delay from CS to OUTx	$I_{LIM} = 0.5\text{ V}$ , measured on OUTx, CS = threshold + 60 mV	-	25	40	ns
Propagation delay from CS to CLF	$I_{LIM} = 0.5\text{ V}$ , measured on CLF, CS = threshold + 60 mV	-	25	50	
<b>CURRENT SENSE DISCHARGE TRANSISTOR</b>					
Discharge resistance	IN = low, resistance from CS to AGND	10	35	75	$\Omega$
<b>OUTPUT DRIVERS</b>					
Source current	$V_{DD} = 12\text{ V}$ , IN = high, OUTx = 5 V		4		A
Sink current	$V_{DD} = 12\text{ V}$ , IN = low, OUTx = 5 V		4		
Source current	$V_{DD} = 4.75\text{ V}$ , IN = high, OUTx = 0		2		
Sink current	$V_{DD} = 4.75\text{ V}$ , IN = low, OUTx = 4.75 V		3		
Rise time, $t_R$	$C_{LOAD} = 2.2\text{ nF}$ , $V_{DD} = 12\text{ V}$		10	20	ns
Fall time, $t_F$	$C_{LOAD} = 2.2\text{ nF}$ , $V_{DD} = 12\text{ V}$		10	15	
Output with $V_{DD} < UVLO$	$V_{DD} = 1.0\text{ V}$ , $I_{SINK} = 10\text{ mA}$		0.8	1.2	V
Propagation delay from IN to OUT1, $t_{D1}$	$C_{LOAD} = 2.2\text{ nF}$ , $V_{DD} = 12\text{ V}$ , CLK rising		20	35	ns
Propagation delay from IN to OUT2, $t_{D2}$	$C_{LOAD} = 2.2\text{ nF}$ , $V_{DD} = 12\text{ V}$ , CLK falling		20	35	

FUNCTIONAL BLOCK DIAGRAM

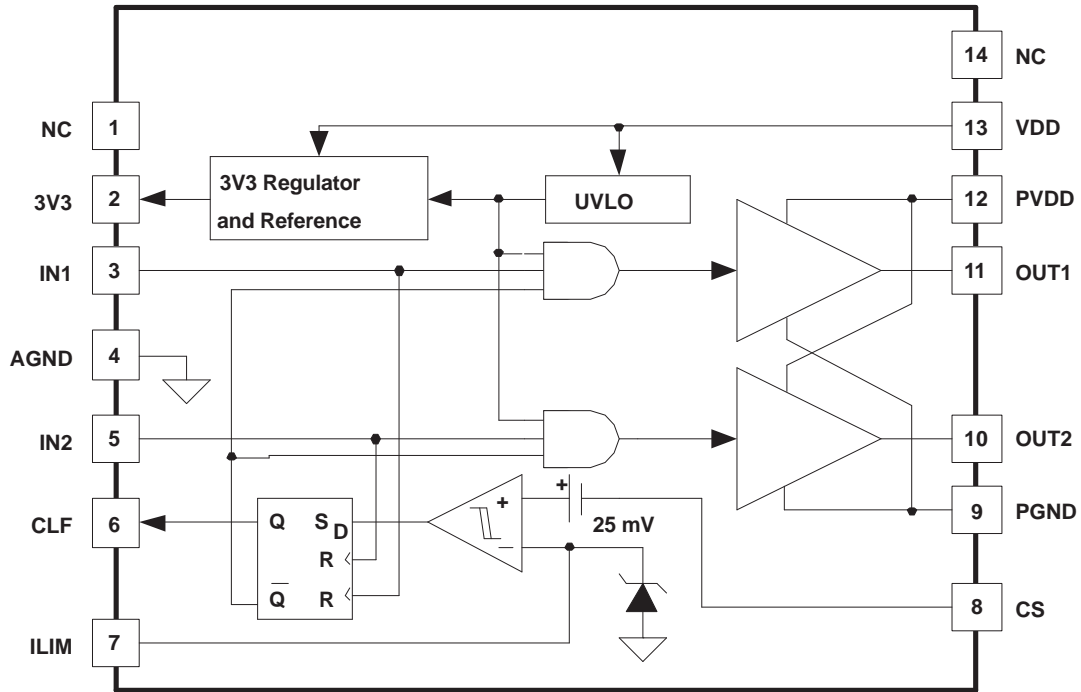
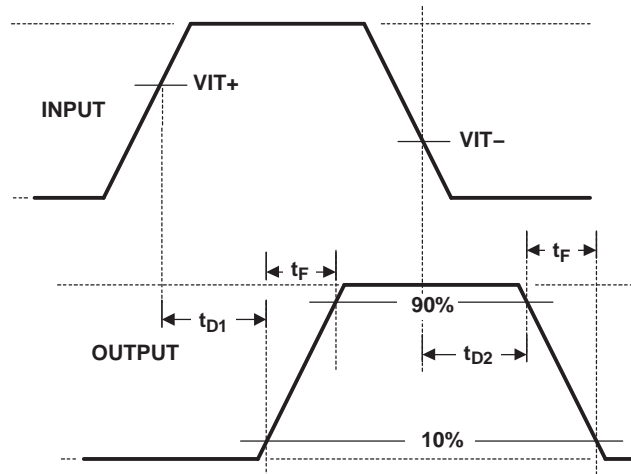

Figure 1. UCD7201

Timing Diagram



## TERMINAL FUNCTIONS

UCD7201		PIN NAME	I/O	FUNCTION
HTSSOP -14 PIN #	QFN-16 PIN #			
1	-	NC	-	No Connection
2	1	3V3	O	Regulated 3.3-V rail. The onboard linear voltage regulator is capable of sourcing up to 10 mA of current. Place 0.22 $\mu$ F of ceramic capacitance from this pin to ground.
3	2	IN1	I	The IN pin is a high impedance digital input capable of accepting 3.3-V logic level signals up to 2 MHz. There is an internal Schmitt trigger comparator which isolates the internal circuitry from any external noise.
4	3	AGND	-	Analog ground return.
5	4	IN2	I	The IN pin is a high impedance digital input capable of accepting 3.3-V logic level signals up to 2 MHz. There is an internal Schmitt trigger comparator which isolates the internal circuitry from any external noise.
6	5	CLF	O	Current limit flag. When the CS level is greater than the ILIM voltage minus 25 mV, the output of the driver is forced low and the current limit flag (CLF) is set high. The CLF signal is latched high until the device receives the next rising edge on the IN pin.
7	6	ILIM	I	Current limit threshold set pin. The current limit threshold can be set to any value between 0.25 V and 1.0 V. The default value while open is 0.5 V.
8	7	CS	I	Current sense pin. Fast current limit comparator connected to the CS pin is used to protect the power stage by implementing cycle-by-cycle current limiting.
9	8, 9	PGND	-	Power ground return. The pin should be connected very closely to the source of the power MOSFET.
10	10	OUT2	O	The high-current TrueDrive™ driver output.
11	11	OUT1	O	The high-current TrueDrive™ driver output.
12	12	PVDD	I	Supply pin provides power for the output drivers. It is not connected internally to the VDD supply rail. The bypass capacitor for this pin should be returned to PGND.
13	13	VDD	I	Supply input pin to power the driver. The UCD7K devices accept an input range of 4.5 V to 15 V. Bypass the pin with at least 4.7 $\mu$ F of capacitance, returned to AGND.
14	14, 15, 16	NC	-	No Connection.

## APPLICATION INFORMATION

The UCD7201 is member of the UCD7K family of digital compatible drivers targeting applications utilizing digital control techniques or applications that require local fast peak current limit protection.

### Supply

The UCD7K devices accept a supply range of 4.5 V to 15 V. The device has an internal precision linear regulator that produces the 3V3 output from this VDD input. A separate pin, PVDD, not connected internally to the VDD supply rail provides power for the output drivers. In all applications the same bus voltage supplies the two pins. It is recommended that a low value of resistance be placed between the two pins so that the local capacitance on each pin forms low pass filters to attenuate any switching noise that may be on the bus.

Although quiescent VDD current is low, total supply current depends on the gate drive output current required for capacitive load and switching frequency. Total VDD current is the sum of quiescent VDD current and the average OUT current. Knowing the operating frequency and the MOSFET gate charge ( $Q_G$ ), average OUT current can be calculated from:

$$I_{OUT} = Q_G \times f, \text{ where } f \text{ is frequency.}$$

For the best high-speed circuit performance, VDD bypass capacitors are recommended to prevent noise problems. A 4.7- $\mu$ F ceramic capacitor should be located closest to the VDD and the AGND connection. In addition, a larger capacitor with relatively low ESR should be connected to the PVDD and PGND pin, to help deliver the high current peaks to the load. The capacitors should present a low impedance characteristic for the expected current levels in the driver application. The use of surface mount components for all bypass capacitors is highly recommended.

### Reference / External Bias Supply

All devices in the UCD7K family are capable of supplying a regulated 3.3-V rail to power various types of external loads such as a microcontroller or an ASIC. The onboard linear voltage regulator is capable of sourcing up to 10 mA of current. For normal operation, place 0.22- $\mu$ F of ceramic capacitance between the 3V3 pin to the AGND pin.

### Input Pin

The input pins are high impedance digital inputs capable of accepting 3.3-V logic level signals up to 2 MHz. There is an internal Schmitt Trigger comparator which isolates the internal circuitry from any external noise.

If limiting the rise or fall times to the power device is desired then an external resistance may be added between the output of the driver and the load device, which is generally the gate of a power MOSFET.

### Current Sensing and Protection

A very fast current limit comparator connected to the CS pin is used to protect the power stage by implementing cycle-by-cycle current limiting.

The current limit threshold may be set to any value between 0.25 V and 1.0 V by applying the desired threshold voltage to the current limit (ILIM) pin. If the ILIM pin is left floating, the internal current limit threshold will be 0.5 volts. When the CS level is greater than the  $I_{LIM}$  voltage minus 25 mV, the output of the driver is forced low and the current limit flag (CLF) is set high. The CLF signal is latched high until the device receives the next rising edge on either of the IN pins.

When the CS voltage is below  $I_{LIM}$ , the driver output follows the PWM input. The CLF digital output flag can be monitored by the host controller to determine when a current limit event occurs and to then apply the appropriate algorithm to obtain the desired current limit profile (i.e. straight time, fold back, hickup or latch-off).

A benefit of this local protection feature is that the UCD7K devices can protect the power stage if the software code in the digital controller becomes corrupted. If the controller's PWM output stays high, the local current sense circuit turns off the driver output when an over-current event occurs. The system would then likely go into retry mode because most DSP and microcontrollers have on-board watchdog, brown-out, and other supervisory peripherals to restart the device in the event that it is not operating properly. But these peripherals typically do not react fast enough to save the power stage. The UCD7K's local current limit comparator provides the required fast protection for the power stage.

The CS threshold is 25 mV below the  $I_{LIM}$  voltage. If the user attempts to command zero current while the CS pin is at ground the CLF flag will latch high until the IN pin receives a pulse. At start-up it is necessary to ensure that the ILIM pin will always be greater than the CS pin for the handshaking to work as described below. If for any reason the CS pin comes to within 25 mV of the ILIM pin during start-up, then the CLF flag will be latched high and the digital controller must poll the UCD7K device, by sending it a narrow IN pulse. If a fault condition is not present the IN pulse will reset the CLF signal to low indicating that the UCD7K device is ready to process power pulses.

### Handshaking

The UCD7K family of devices have a built-in handshaking feature to facilitate efficient start-up of the digitally controlled power supply. At start-up the CLF flag is held high until all the internal and external supply voltages of the UCD7K device are within their operating range. Once the supply voltages are within acceptable limits, the CLF goes low and the device will process input drive signals. The micro-controller should monitor the CFL flag at start-up and wait for the CLF flag to go LOW before sending power pulses to the UCD7K device.

### Driver Output

The high-current output stage of the UCD7K device family is capable of supplying  $\pm 4$ -A peak current pulses and swings to both PVDD and PGND. The driver outputs follow the state of the IN pin provided that the VDD and 3V3 voltages are above their respective under-voltage lockout threshold.

The drive output utilizes Texas Instruments' TrueDrive™ architecture, which delivers rated current into the gate of a MOSFET when it is most needed, during the Miller plateau region of the switching transition providing efficiency gains.

TrueDrive™ consists of pullup pulldown circuits with bipolar and MOSFET transistors in parallel. The peak output current rating is the combined current from the bipolar and MOSFET transistors. This hybrid output stage also allows efficient current sourcing at low supply voltages.

Each output stage also provides a very low impedance to overshoot and undershoot due to the body diode of the external MOSFET. This means that in many cases, external-schottky-clamp diodes are not required.

### Source/Sink Capabilities During Miller Plateau

Large power MOSFETs present a large load to the control circuitry. Proper drive is required for efficient, reliable operation. The UCD7K drivers have been optimized to provide maximum drive to a power MOSFET during the Miller plateau region of the switching transition. This interval occurs while the drain voltage is swinging between the voltage levels dictated by the power topology, requiring the charging/discharging of the drain-gate capacitance with current supplied or removed by the driver device. See Reference [1]

### Drive Current and Power Requirements

The UCD7K family of drivers can deliver high current into a MOSFET gate for a period of several hundred nanoseconds. High peak current is required to turn the device ON quickly. Then, to turn the device OFF, the driver is required to sink a similar amount of current to ground. This repeats at the operating frequency of the power device.

Reference [1] discusses the current required to drive a power MOSFET and other capacitive-input switching devices.

When a driver device is tested with a discrete, capacitive load it is a fairly simple matter to calculate the power that is required from the bias supply. The energy that must be transferred from the bias supply to charge the capacitor is given by:

$$E = \frac{1}{2} \times CV^2 \quad (1)$$

where C is the load capacitor and V is the bias voltage feeding the driver.

There is an equal amount of energy transferred to ground when the capacitor is discharged. This leads to a power loss given by the following:

$$P = CV^2 \times f \quad (2)$$

where f is the switching frequency.

This power is dissipated in the resistive elements of the circuit. Thus, with no external resistor between the driver and gate, this power is dissipated inside the driver. Half of the total power is dissipated when the capacitor is charged, and the other half is dissipated when the capacitor is discharged.

With  $V_{DD} = 12\text{ V}$ ,  $C_{LOAD} = 2.2\text{ nF}$ , and  $f = 300\text{ kHz}$ , the power loss can be calculated as:

$$P = 2.2\text{ nF} \times 12^2 \times 300\text{ kHz} = 0.095\text{ W} \quad (3)$$

With a 12-V supply, this would equate to a current of:

$$I = \frac{P}{V} = \frac{0.095\text{ W}}{12\text{ V}} = 7.9\text{ mA} \quad (4)$$

### Operational Waveforms

[Figure 24](#) shows the circuit performance achievable with the output driving a 10-nF load at 12-V  $V_{DD}$ . The input pulsewidth (not shown) is set to 200 ns to show both transitions in the output waveform. Note the linear rising and falling edges of the switching waveforms. This is due to the constant output current characteristic of TrueDrive™ stage as opposed to the resistive output impedance of traditional MOSFET-based gate drivers.

### Thermal Information

The useful range of a driver is greatly affected by the drive power requirements of the load and the thermal characteristics of the device package. In order for a power driver to be useful over a particular temperature range the package must allow for the efficient removal of the heat produced while keeping the junction temperature within rated limits. The UCD7K family of drivers is available in PowerPAD™ TSSOP and QFN/DFN packages to cover a range of application requirements. Both have an exposed pad to enhance thermal conductivity from the semiconductor junction.

As illustrated in Reference [2], the PowerPAD™ packages offer a leadframe die pad that is exposed at the base of the package. This pad is soldered to the copper on the PC board (PCB) directly underneath the device package, reducing the  $T_{JC}$  down to 2.07°C/W. The PC board must be designed with thermal lands and thermal vias to complete the heat removal subsystem, as summarized in Reference [3].

Note that the PowerPAD™ is not directly connected to any leads of the package. However, it is electrically and thermally connected to the substrate which is the ground of the device. The PowerPad™ should be connected to the quiet ground of the circuit.

### Circuit Layout Recommendations

In a power driver operating at high frequency, it is critical to minimize stray inductance to minimize overshoot/undershoots and ringing. The low output impedance of these drivers produces waveforms with high di/dt. This tends to induce ringing in the parasitic inductances. It is advantageous to connect the driver device close to the MOSFETs. It is recommended that the PGND and the AGND pins be connected to the PowerPad™ of the package with a thin trace. It is critical to ensure that the voltage potential between these two pins does not exceed 0.3 V. The use of schottky diodes on the outputs to PGND and PVDD is recommended when driving gate transformers.



Typical Characteristics

UVLO THRESHOLDS  
vs  
TEMPERATURE

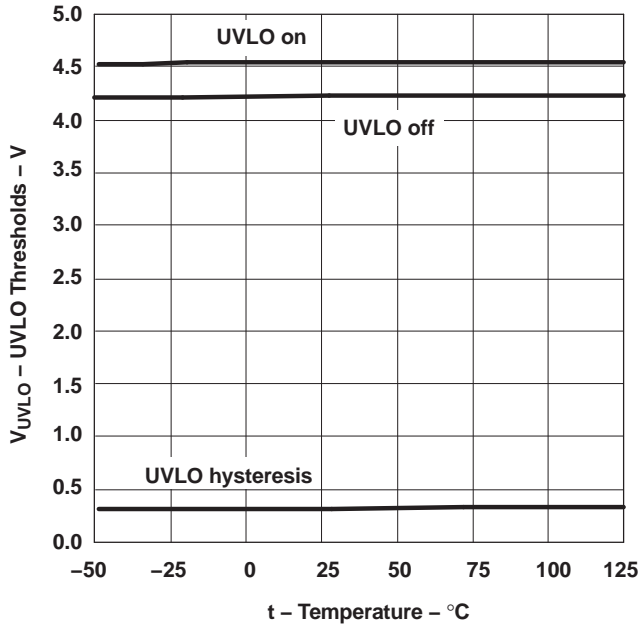

Figure 4.

3V3 REFERENCE VOLTAGE  
vs  
TEMPERATURE

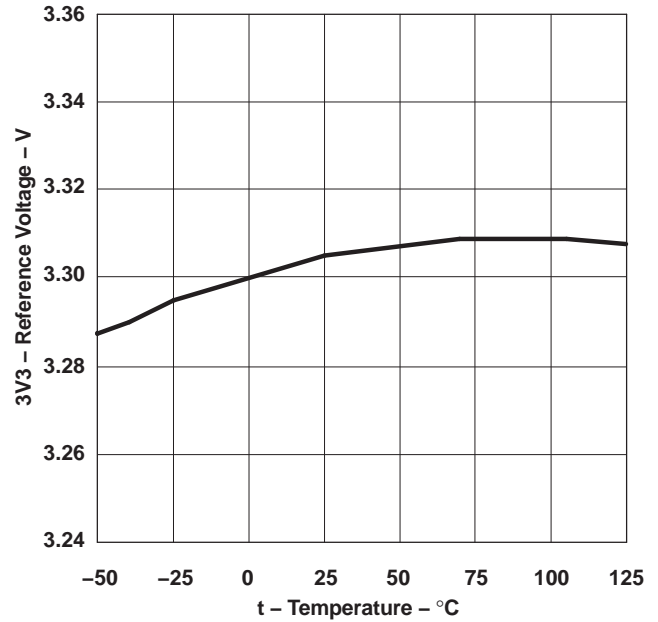

Figure 5.

3V3 SHORT CIRCUIT CURRENT  
vs  
TEMPERATURE

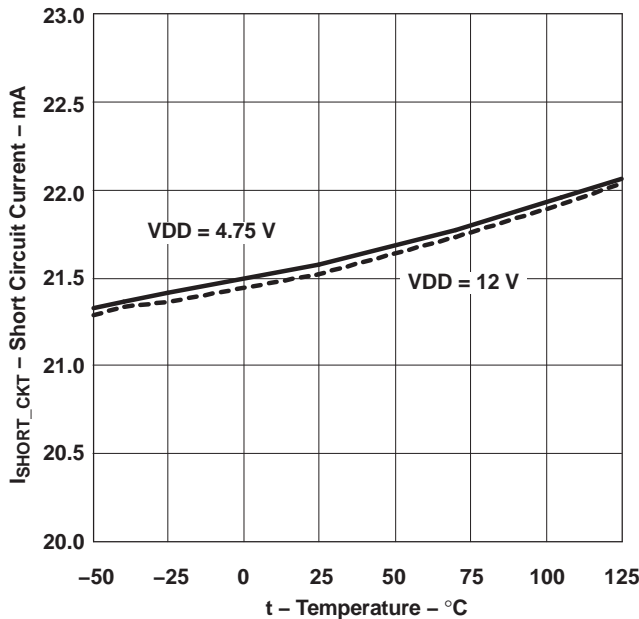

Figure 6.

SUPPLY CURRENT  
vs  
FREQUENCY (V<sub>DD</sub> = 5 V)

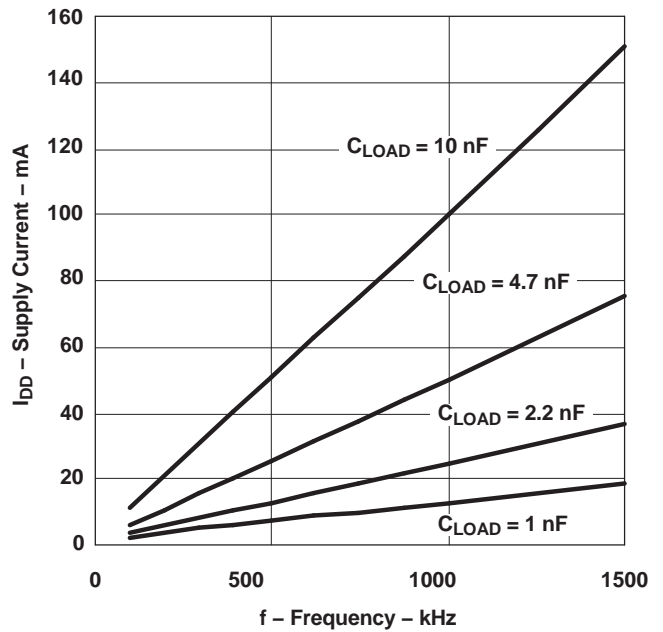

Figure 7.

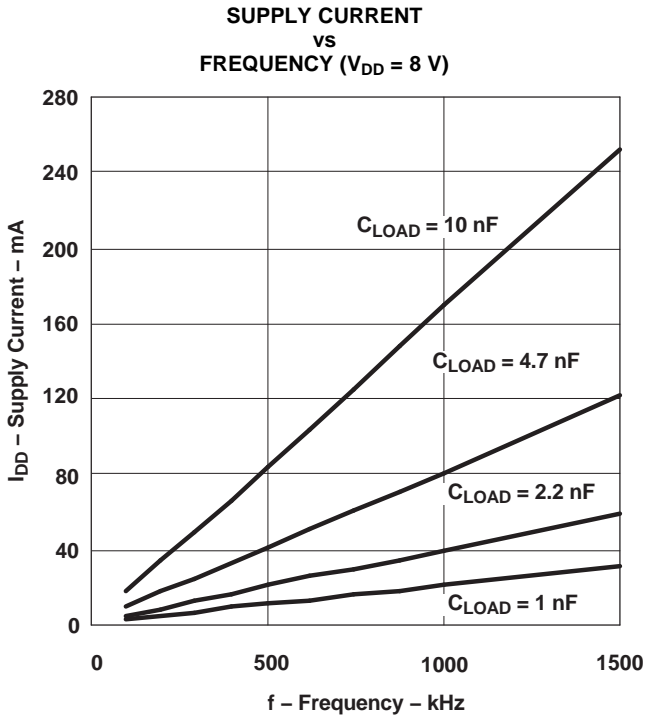

Figure 8.

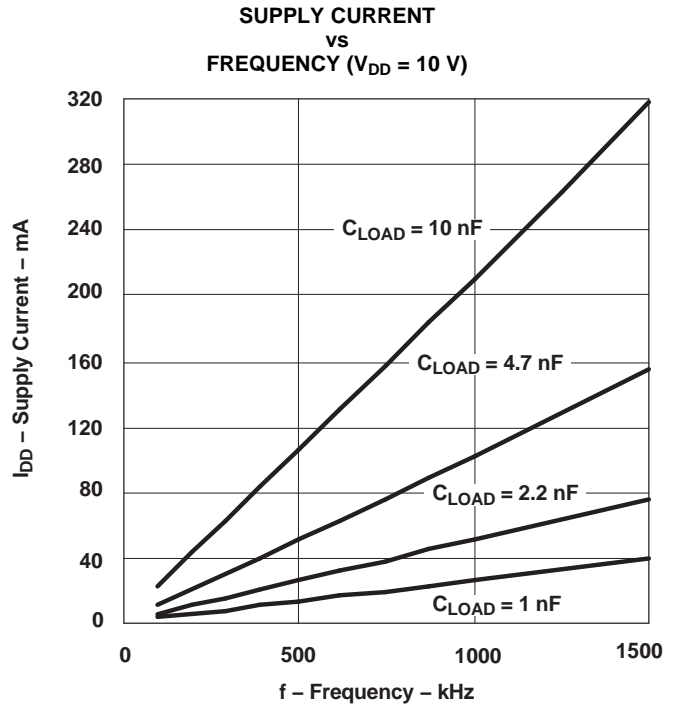

Figure 9.

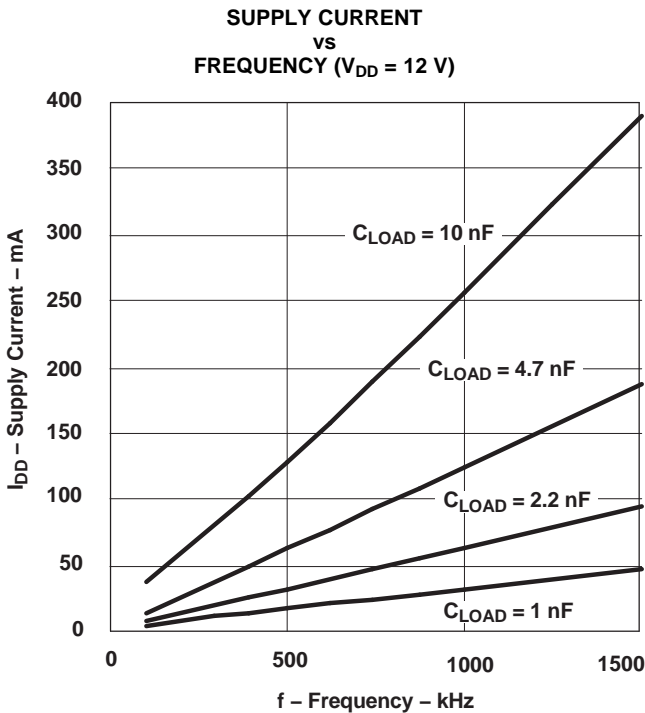

Figure 10.

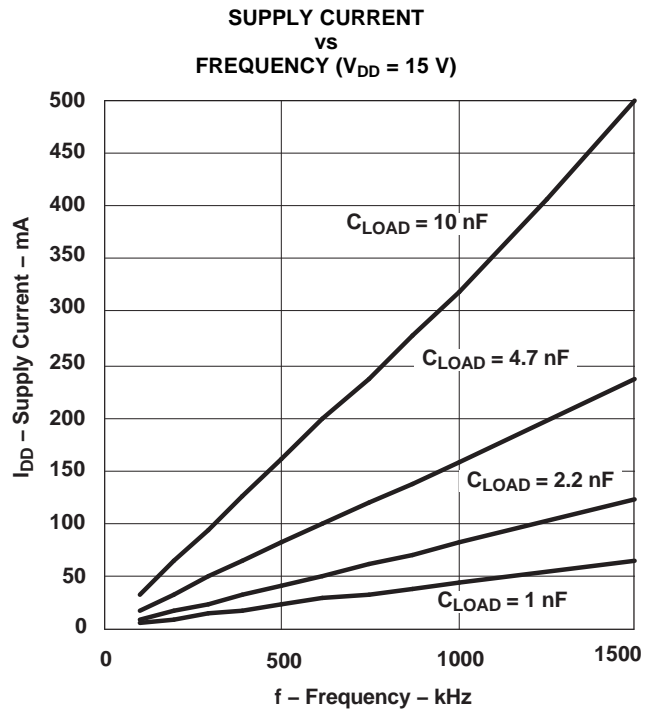

Figure 11.

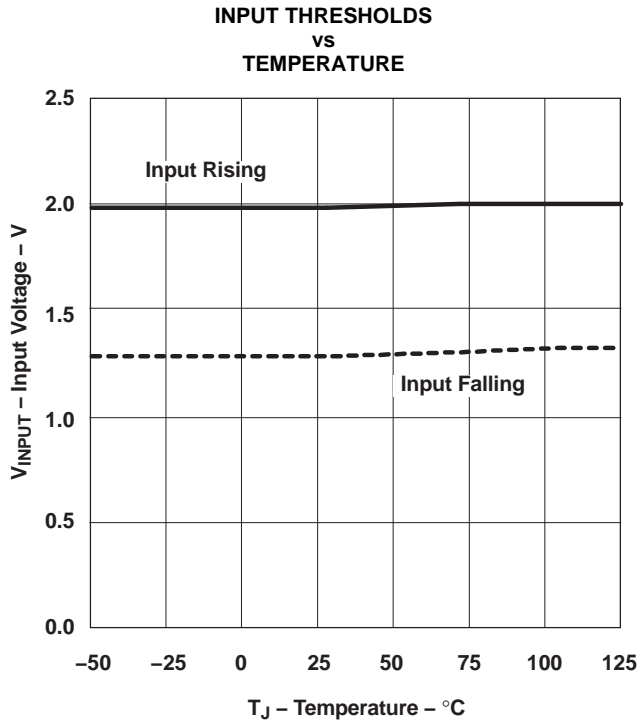

Figure 12.

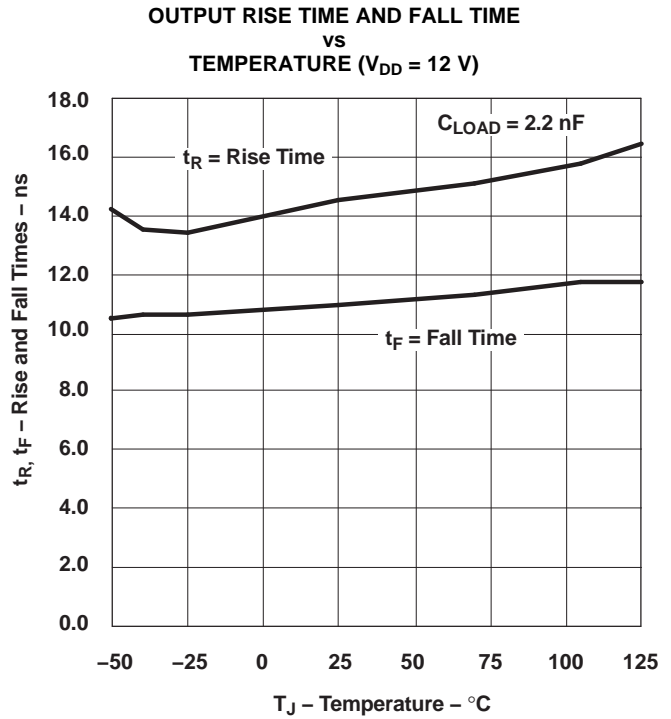

Figure 13.

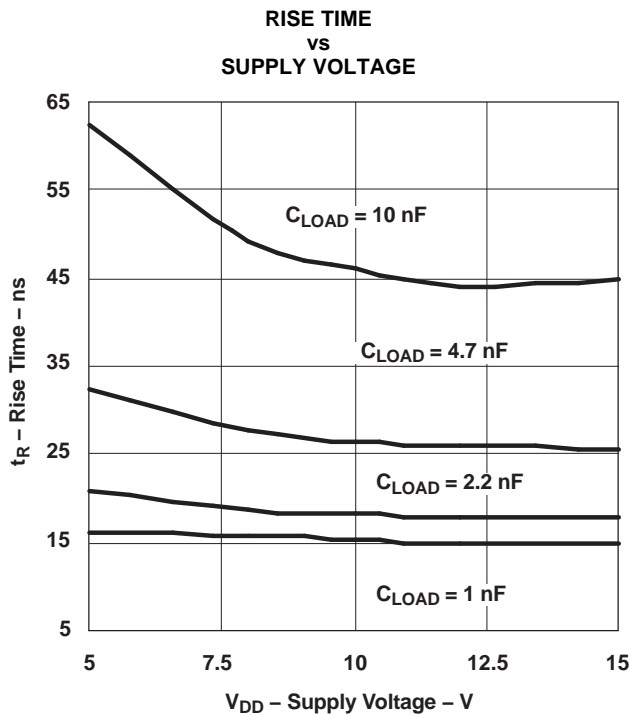

Figure 14.

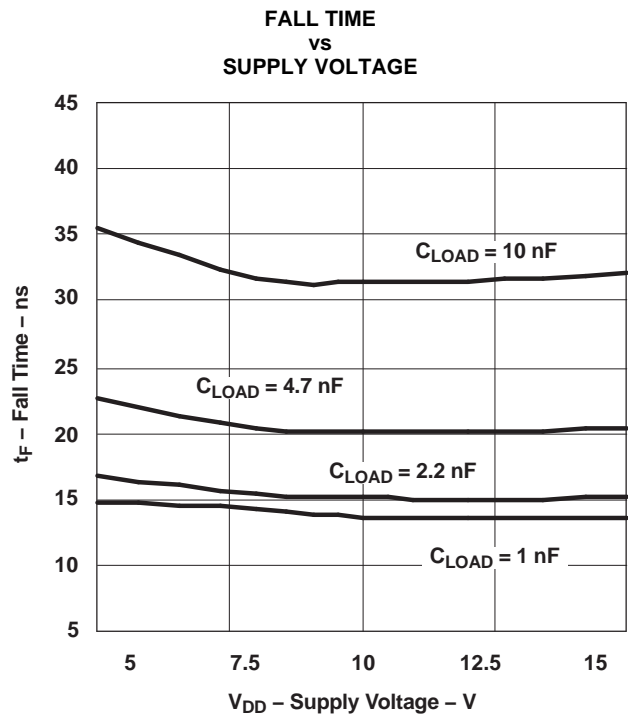

Figure 15.

**IN to OUTx PROPAGATION DELAY RISING  
vs  
SUPPLY VOLTAGE**

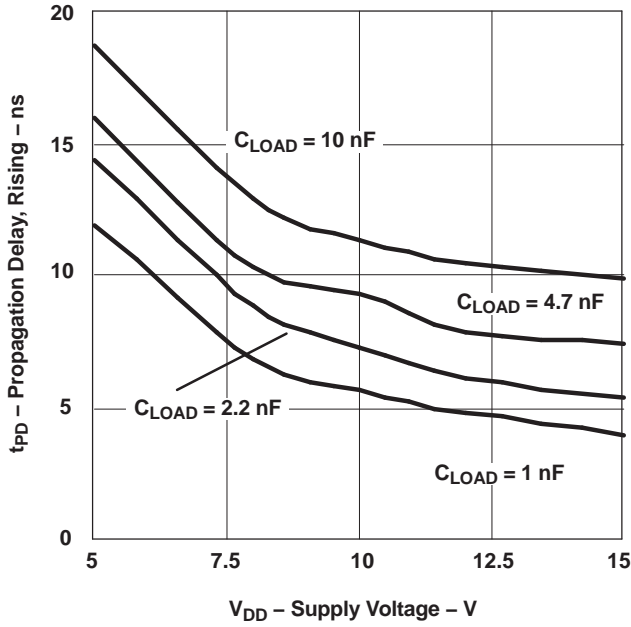

Figure 16.

**IN to OUTx PROPAGATION DELAY FALLING  
vs  
SUPPLY VOLTAGE**

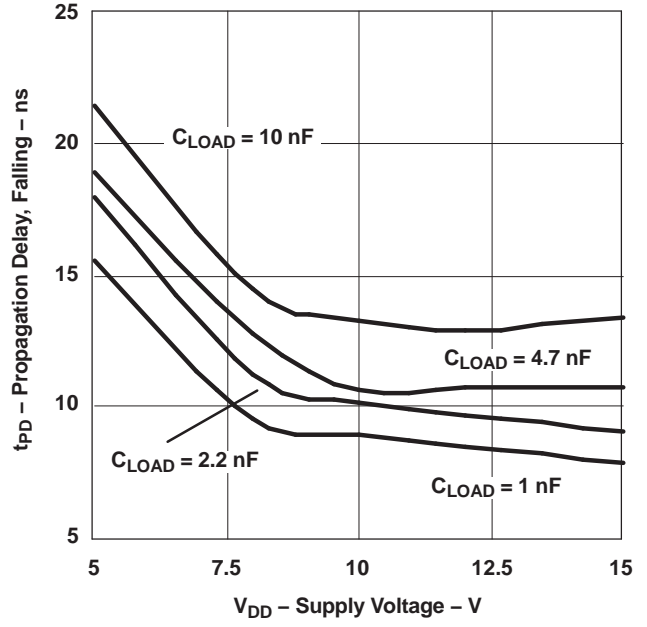

Figure 17.

**DEFAULT CURRENT LIMIT THRESHOLD  
vs  
TEMPERATURE**

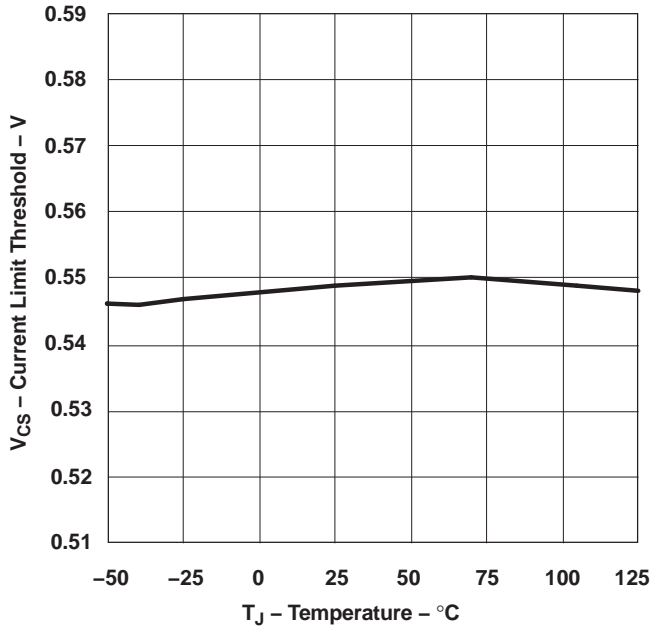

Figure 18.

**CS TO OUTx PROPAGATION DELAY  
vs  
TEMPERATURE**

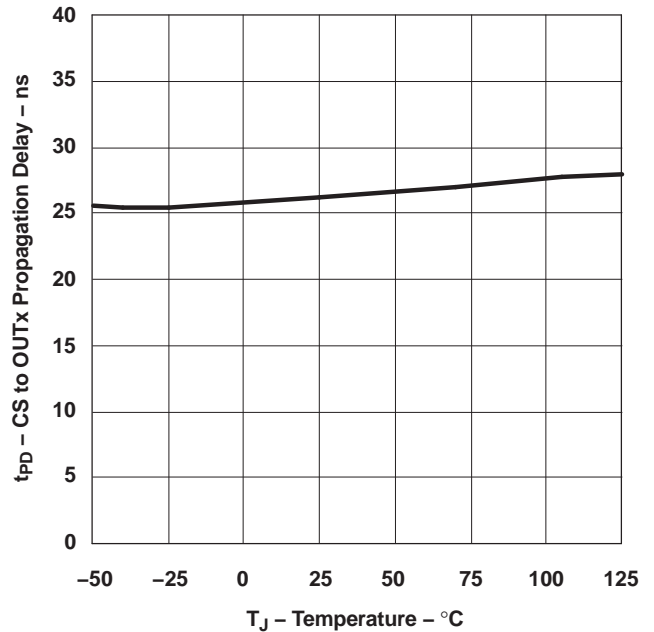

Figure 19.

CS TO CLF PROPAGATION DELAY  
vs  
TEMPERATURE

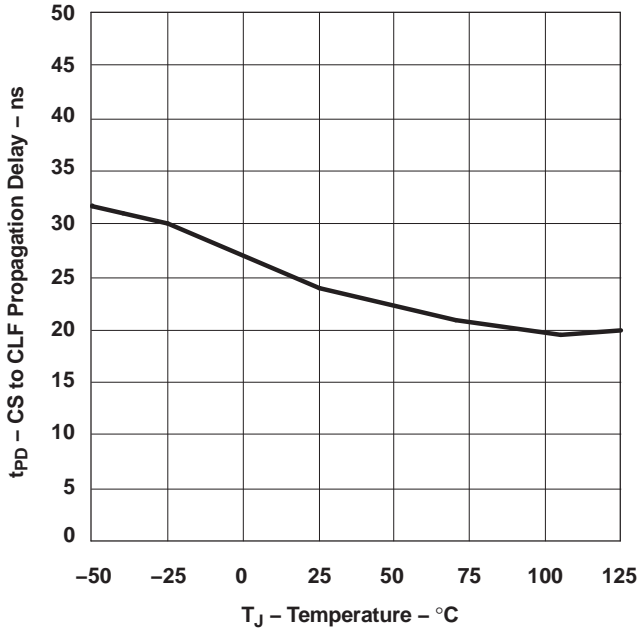

Figure 20.

IN TO OUT PROPAGATION DELAY  
vs  
TEMPERATURE

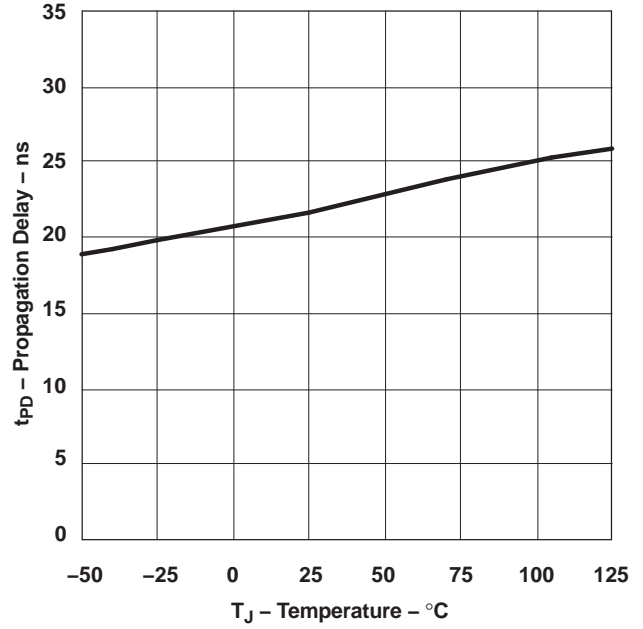
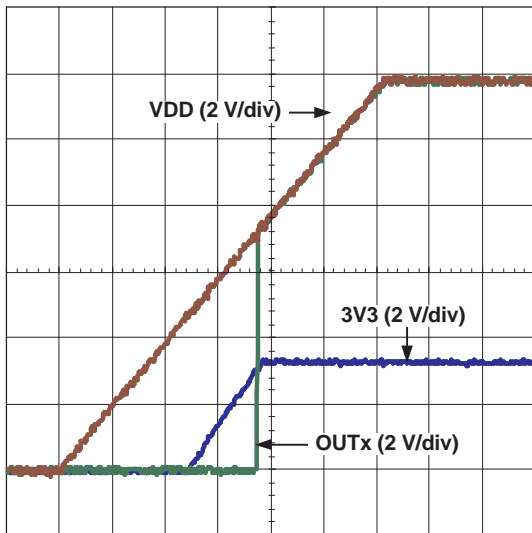

Figure 21.

START-UP BEHAVIOR AT V<sub>DD</sub> = 12 V (INPUT TIED TO 3V3)



t - Time - 40 μs/div

Figure 22.

SHUT DOWN BEHAVIOR AT V<sub>DD</sub> = 12 V (INPUT TIED TO 3V3)

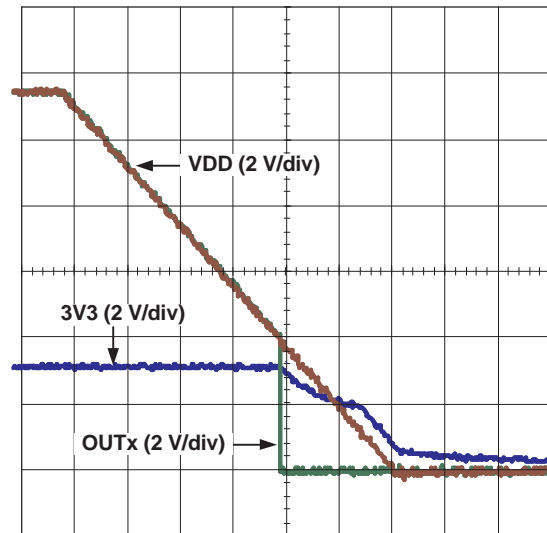

t - Time - 40 μs/div

Figure 23.

START-UP BEHAVIOR AT  $V_{DD} = 12\text{ V}$  (INPUT SHORTED TO GND)

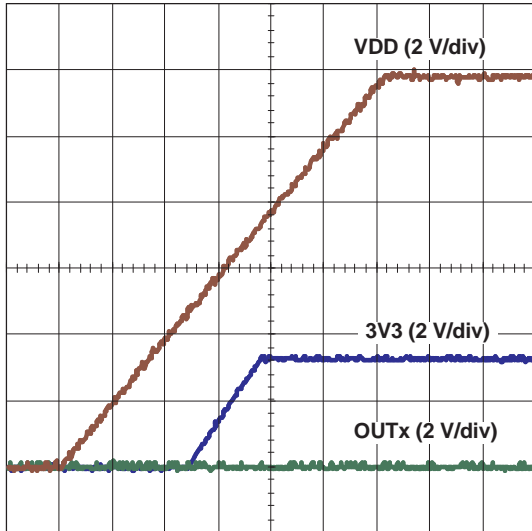

t – Time – 40  $\mu\text{s}/\text{div}$

Figure 24.

SHUT DOWN BEHAVIOR AT  $V_{DD} = 12\text{ V}$  (INPUT SHORTED TO GND)

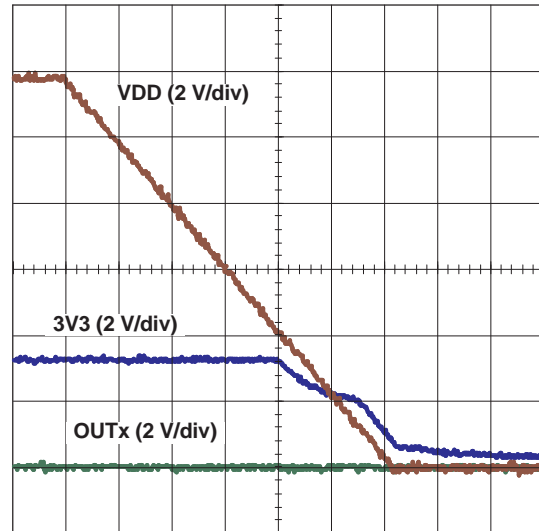

t – Time – 40  $\mu\text{s}/\text{div}$

Figure 25.

OUTPUT RISE AND FALL TIME ( $V_{DD} = 12\text{ V}$ ,  $C_{LOAD} = 10\text{ nF}$ )

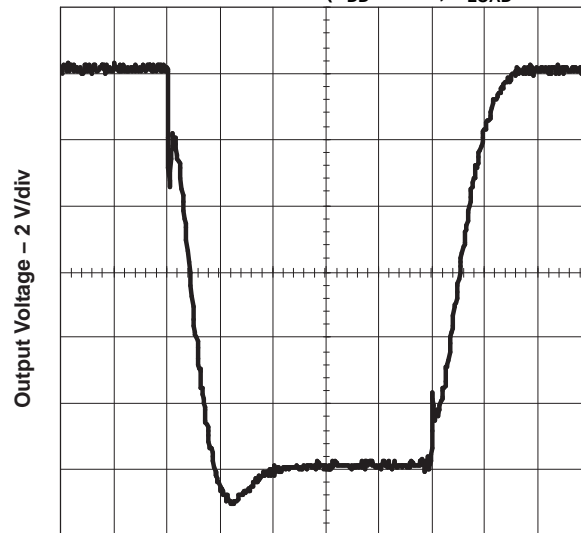

t – Time – 40  $\text{ns}/\text{div}$

Figure 26.

## REFERENCES

1. Power Supply Seminar SEM-1400 Topic 2: Design And Application Guide For High Speed MOSFET Gate Drive Circuits, by Laszlo Balogh, Texas Instruments Literature No. SLUP133.
2. Technical Brief, PowerPad Thermally Enhanced Package, Texas Instruments Literature No. SLMA002
3. Application Brief, PowerPAD Made Easy, Texas Instruments Literature No. SLMA004

## RELATED PRODUCTS

TEMPERATURE RANGE	CURRENT SENSE LIMIT PER CHANNEL	FEATURES
UCD7100	Single Low Side $\pm 4$ -A Driver with Independent CS	3V3, CS <sup>(1)</sup> (2)
UCD7200	Dual Low Side $\pm 4$ -A Drivers with Independent CS	3V3, CS <sup>(1)</sup> (2)
UCD7230	$\pm 4$ -A Synchronous Buck Driver with CS	3V3, CS <sup>(1)</sup> (2)
UCD7500	Single Low Side $\pm 4$ -A Driver with CS and 110-V High Voltage Startup	3v3, CS, HVS110 <sup>(1)</sup> (2) (3)
UCD7600	Dual Low Side $\pm 4$ -A Drivers with Independent CS and 110-V High Voltage Startup	3V3, CS, HVS110 <sup>(1)</sup> (2) (3)
UCD7601	Dual Low Side $\pm 4$ -A Drivers with Common CS and 110-V High Voltage Startup	3V3, CCS, HVS110 <sup>(1)</sup> (4) (3)
UCD9110	Digital Power Controller for High Performance Single-loop Applications	
UCD9501	Digital Power Controller for High Performance Multi-Loop Applications	

- (1) 3V3 = 3.3-V linear regulator.  
 (2) CS = current sense and current limit function.  
 (3) HVS110 = 110-V high voltage startup circuit.  
 (4) CCS = Common current sense and current limit function.

## REVISION HISTORY

DATE	REVISION	CHANGE DESCRIPTION
3/4/05	SLUS645	Initial release of preliminary datasheet.
4/1/05	SLUS645A	Updated packaging information.
7/14/05	SLUS645B	Initial release of production datasheet. Updated specification and application information.

**PACKAGING INFORMATION**

Orderable Device	Status <sup>(1)</sup>	Package Type	Package Drawing	Pins	Package Qty	Eco Plan <sup>(2)</sup>	Lead/Ball Finish	MSL Peak Temp <sup>(3)</sup>
UCD7201PWP	ACTIVE	HTSSOP	PWP	14	90	Green (RoHS & no Sb/Br)	CU NIPDAU	Level-2-260C-1 YEAR
UCD7201PWPG4	ACTIVE	HTSSOP	PWP	14	90	Green (RoHS & no Sb/Br)	CU NIPDAU	Level-2-260C-1 YEAR
UCD7201PWPR	ACTIVE	HTSSOP	PWP	14	2000	Green (RoHS & no Sb/Br)	CU NIPDAU	Level-2-260C-1 YEAR
UCD7201PWPRG4	ACTIVE	HTSSOP	PWP	14	2000	Green (RoHS & no Sb/Br)	CU NIPDAU	Level-2-260C-1 YEAR

<sup>(1)</sup> The marketing status values are defined as follows:

**ACTIVE:** Product device recommended for new designs.

**LIFEBUY:** TI has announced that the device will be discontinued, and a lifetime-buy period is in effect.

**NRND:** Not recommended for new designs. Device is in production to support existing customers, but TI does not recommend using this part in a new design.

**PREVIEW:** Device has been announced but is not in production. Samples may or may not be available.

**OBSOLETE:** TI has discontinued the production of the device.

<sup>(2)</sup> Eco Plan - The planned eco-friendly classification: Pb-Free (RoHS), Pb-Free (RoHS Exempt), or Green (RoHS & no Sb/Br) - please check <http://www.ti.com/productcontent> for the latest availability information and additional product content details.

**TBD:** The Pb-Free/Green conversion plan has not been defined.

**Pb-Free (RoHS):** TI's terms "Lead-Free" or "Pb-Free" mean semiconductor products that are compatible with the current RoHS requirements for all 6 substances, including the requirement that lead not exceed 0.1% by weight in homogeneous materials. Where designed to be soldered at high temperatures, TI Pb-Free products are suitable for use in specified lead-free processes.

**Pb-Free (RoHS Exempt):** This component has a RoHS exemption for either 1) lead-based flip-chip solder bumps used between the die and package, or 2) lead-based die adhesive used between the die and leadframe. The component is otherwise considered Pb-Free (RoHS compatible) as defined above.

**Green (RoHS & no Sb/Br):** TI defines "Green" to mean Pb-Free (RoHS compatible), and free of Bromine (Br) and Antimony (Sb) based flame retardants (Br or Sb do not exceed 0.1% by weight in homogeneous material)

<sup>(3)</sup> MSL, Peak Temp. -- The Moisture Sensitivity Level rating according to the JEDEC industry standard classifications, and peak solder temperature.

**Important Information and Disclaimer:**The information provided on this page represents TI's knowledge and belief as of the date that it is provided. TI bases its knowledge and belief on information provided by third parties, and makes no representation or warranty as to the accuracy of such information. Efforts are underway to better integrate information from third parties. TI has taken and continues to take reasonable steps to provide representative and accurate information but may not have conducted destructive testing or chemical analysis on incoming materials and chemicals. TI and TI suppliers consider certain information to be proprietary, and thus CAS numbers and other limited information may not be available for release.

In no event shall TI's liability arising out of such information exceed the total purchase price of the TI part(s) at issue in this document sold by TI to Customer on an annual basis.

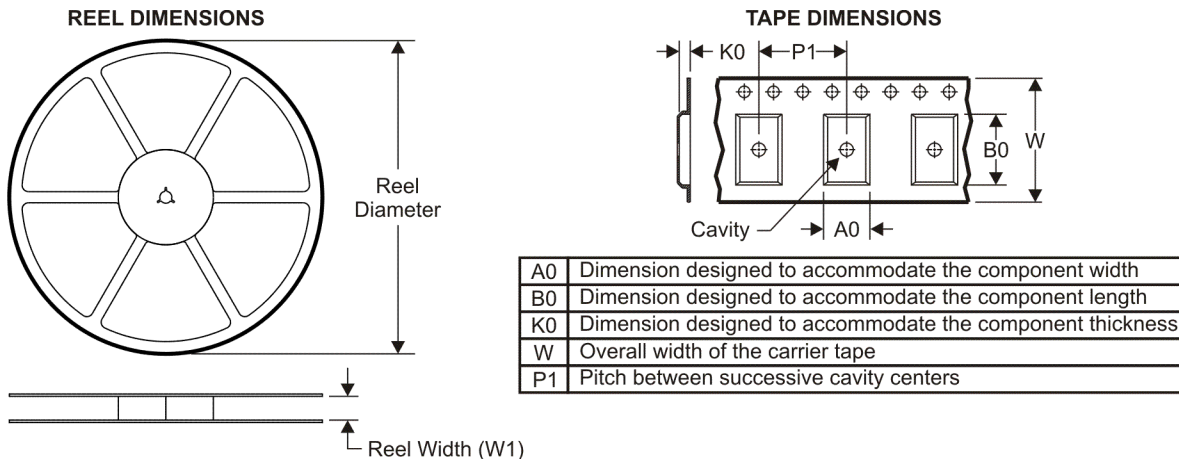
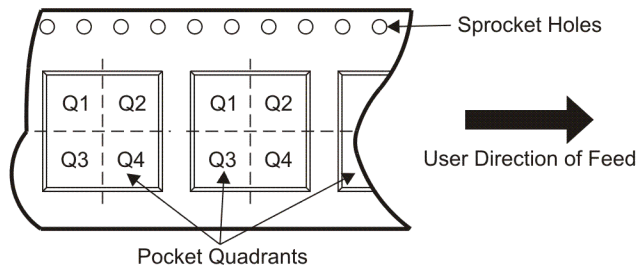
**TAPE AND REEL INFORMATION**

**QUADRANT ASSIGNMENTS FOR PIN 1 ORIENTATION IN TAPE**

\*All dimensions are nominal

Device	Package Type	Package Drawing	Pins	SPQ	Reel Diameter (mm)	Reel Width W1 (mm)	A0 (mm)	B0 (mm)	K0 (mm)	P1 (mm)	W (mm)	Pin1 Quadrant
UCD7201PWPR	HTSSOP	PWP	14	2000	330.0	12.4	6.9	5.6	1.6	8.0	12.0	Q1

TAPE AND REEL BOX DIMENSIONS



\*All dimensions are nominal

Device	Package Type	Package Drawing	Pins	SPQ	Length (mm)	Width (mm)	Height (mm)
UCD7201PWPR	HTSSOP	PWP	14	2000	346.0	346.0	29.0

PWP (R-PDSO-G14)

PowerPAD™ PLASTIC SMALL OUTLINE

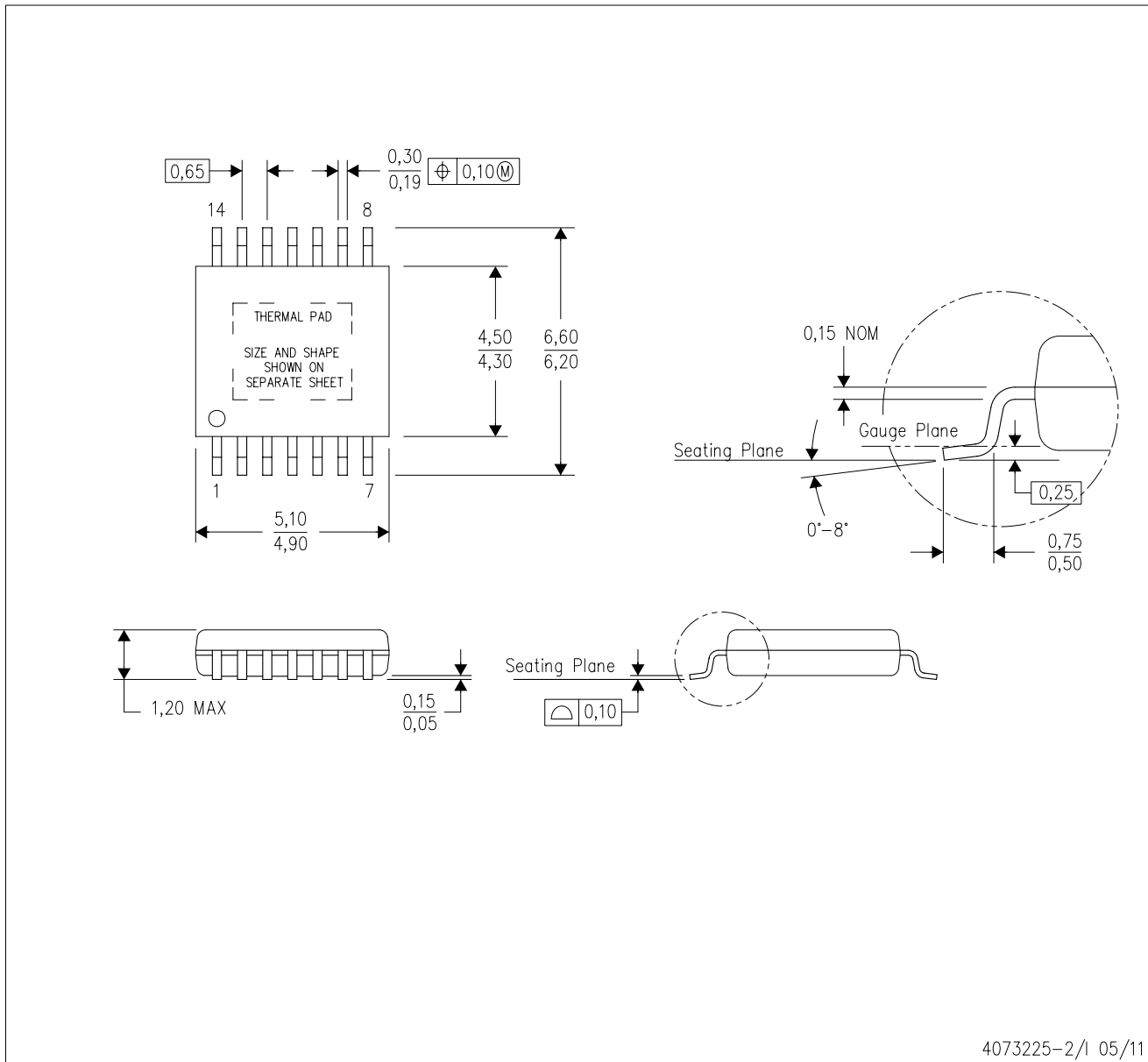

4073225-2/1 05/11

- NOTES:
- A. All linear dimensions are in millimeters.
  - B. This drawing is subject to change without notice.
  - C. Body dimensions do not include mold flash or protrusions. Mold flash and protrusion shall not exceed 0.15 per side.
  - D. This package is designed to be soldered to a thermal pad on the board. Refer to Technical Brief, PowerPad Thermally Enhanced Package, Texas Instruments Literature No. SLMA002 for information regarding recommended board layout. This document is available at [www.ti.com](http://www.ti.com) <<http://www.ti.com>>.
  - E. See the additional figure in the Product Data Sheet for details regarding the exposed thermal pad features and dimensions.
  - E. Falls within JEDEC MO-153

PowerPAD is a trademark of Texas Instruments.

## THERMAL PAD MECHANICAL DATA

PWP (R-PDSO-G14) PowerPAD™ SMALL PLASTIC OUTLINE

### THERMAL INFORMATION

This PowerPAD™ package incorporates an exposed thermal pad that is designed to be attached to a printed circuit board (PCB). The thermal pad must be soldered directly to the PCB. After soldering, the PCB can be used as a heatsink. In addition, through the use of thermal vias, the thermal pad can be attached directly to the appropriate copper plane shown in the electrical schematic for the device, or alternatively, can be attached to a special heatsink structure designed into the PCB. This design optimizes the heat transfer from the integrated circuit (IC).

For additional information on the PowerPAD package and how to take advantage of its heat dissipating abilities, refer to Technical Brief, PowerPAD Thermally Enhanced Package, Texas Instruments Literature No. SLMA002 and Application Brief, PowerPAD Made Easy, Texas Instruments Literature No. SLMA004. Both documents are available at [www.ti.com](http://www.ti.com).

The exposed thermal pad dimensions for this package are shown in the following illustration.

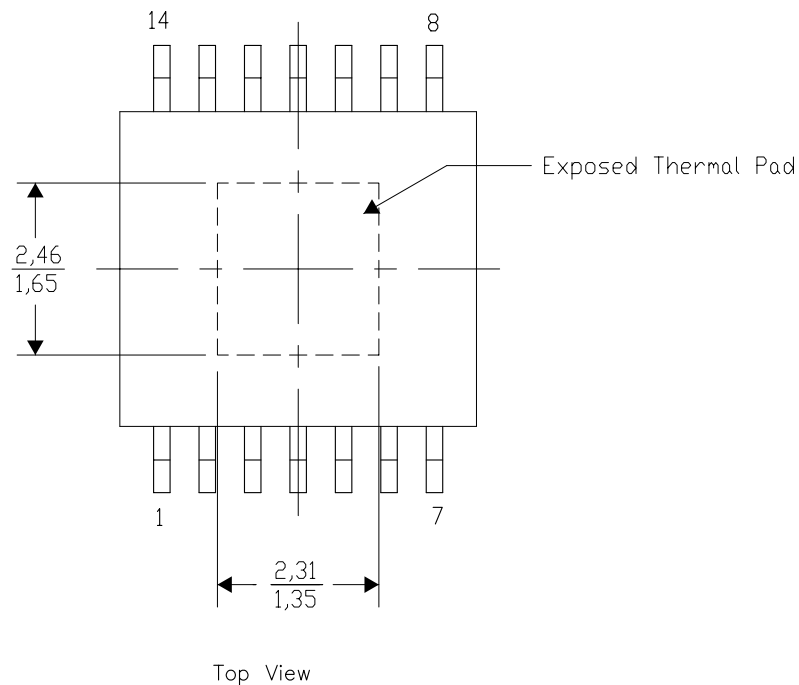

Exposed Thermal Pad Dimensions

4206332-2/W 05/11

NOTE: A. All linear dimensions are in millimeters

PowerPAD is a trademark of Texas Instruments

PWP (R-PDSO-G14)

PowerPAD™ PLASTIC SMALL OUTLINE

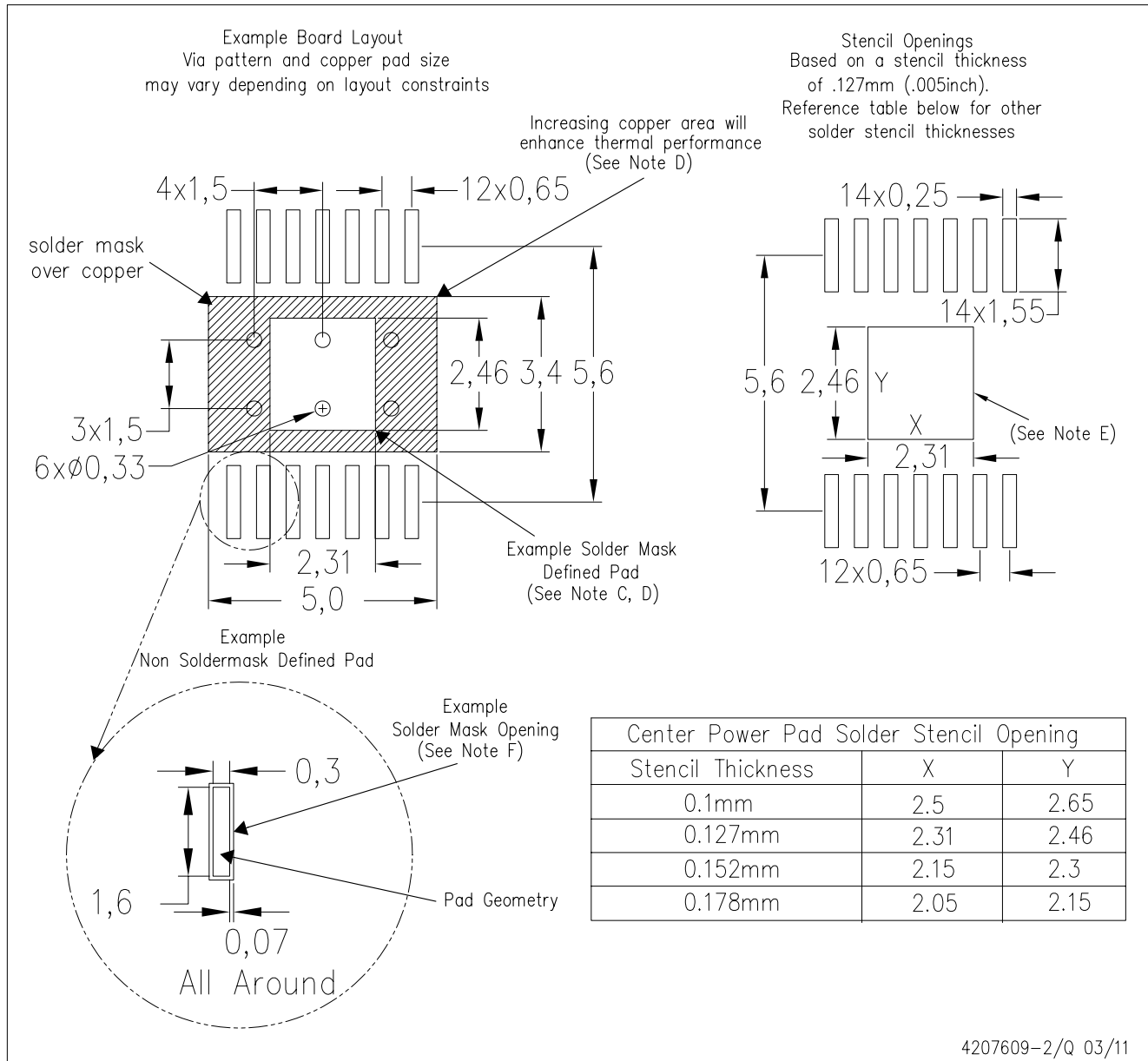

- NOTES:
- A. All linear dimensions are in millimeters.
  - B. This drawing is subject to change without notice.
  - C. Customers should place a note on the circuit board fabrication drawing not to alter the center solder mask defined pad.
  - D. This package is designed to be soldered to a thermal pad on the board. Refer to Technical Brief, PowerPad Thermally Enhanced Package, Texas Instruments Literature No. SLMA002, SLMA004, and also the Product Data Sheets for specific thermal information, via requirements, and recommended board layout. These documents are available at [www.ti.com](http://www.ti.com) <<http://www.ti.com>>. Publication IPC-7351 is recommended for alternate designs.
  - E. Laser cutting apertures with trapezoidal walls and also rounding corners will offer better paste release. Customers should contact their board assembly site for stencil design recommendations. Example stencil design based on a 50% volumetric metal load solder paste. Refer to IPC-7525 for other stencil recommendations.
  - F. Customers should contact their board fabrication site for solder mask tolerances between and around signal pads.

PowerPAD is a trademark of Texas Instruments.

## IMPORTANT NOTICE

Texas Instruments Incorporated and its subsidiaries (TI) reserve the right to make corrections, modifications, enhancements, improvements, and other changes to its products and services at any time and to discontinue any product or service without notice. Customers should obtain the latest relevant information before placing orders and should verify that such information is current and complete. All products are sold subject to TI's terms and conditions of sale supplied at the time of order acknowledgment.

TI warrants performance of its hardware products to the specifications applicable at the time of sale in accordance with TI's standard warranty. Testing and other quality control techniques are used to the extent TI deems necessary to support this warranty. Except where mandated by government requirements, testing of all parameters of each product is not necessarily performed.

TI assumes no liability for applications assistance or customer product design. Customers are responsible for their products and applications using TI components. To minimize the risks associated with customer products and applications, customers should provide adequate design and operating safeguards.

TI does not warrant or represent that any license, either express or implied, is granted under any TI patent right, copyright, mask work right, or other TI intellectual property right relating to any combination, machine, or process in which TI products or services are used. Information published by TI regarding third-party products or services does not constitute a license from TI to use such products or services or a warranty or endorsement thereof. Use of such information may require a license from a third party under the patents or other intellectual property of the third party, or a license from TI under the patents or other intellectual property of TI.

Reproduction of TI information in TI data books or data sheets is permissible only if reproduction is without alteration and is accompanied by all associated warranties, conditions, limitations, and notices. Reproduction of this information with alteration is an unfair and deceptive business practice. TI is not responsible or liable for such altered documentation. Information of third parties may be subject to additional restrictions.

Resale of TI products or services with statements different from or beyond the parameters stated by TI for that product or service voids all express and any implied warranties for the associated TI product or service and is an unfair and deceptive business practice. TI is not responsible or liable for any such statements.

TI products are not authorized for use in safety-critical applications (such as life support) where a failure of the TI product would reasonably be expected to cause severe personal injury or death, unless officers of the parties have executed an agreement specifically governing such use. Buyers represent that they have all necessary expertise in the safety and regulatory ramifications of their applications, and acknowledge and agree that they are solely responsible for all legal, regulatory and safety-related requirements concerning their products and any use of TI products in such safety-critical applications, notwithstanding any applications-related information or support that may be provided by TI. Further, Buyers must fully indemnify TI and its representatives against any damages arising out of the use of TI products in such safety-critical applications.

TI products are neither designed nor intended for use in military/aerospace applications or environments unless the TI products are specifically designated by TI as military-grade or "enhanced plastic." Only products designated by TI as military-grade meet military specifications. Buyers acknowledge and agree that any such use of TI products which TI has not designated as military-grade is solely at the Buyer's risk, and that they are solely responsible for compliance with all legal and regulatory requirements in connection with such use.

TI products are neither designed nor intended for use in automotive applications or environments unless the specific TI products are designated by TI as compliant with ISO/TS 16949 requirements. Buyers acknowledge and agree that, if they use any non-designated products in automotive applications, TI will not be responsible for any failure to meet such requirements.

Following are URLs where you can obtain information on other Texas Instruments products and application solutions:

### Products

Audio	<a href="http://www.ti.com/audio">www.ti.com/audio</a>
Amplifiers	<a href="http://amplifier.ti.com">amplifier.ti.com</a>
Data Converters	<a href="http://dataconverter.ti.com">dataconverter.ti.com</a>
DLP® Products	<a href="http://www.dlp.com">www.dlp.com</a>
DSP	<a href="http://dsp.ti.com">dsp.ti.com</a>
Clocks and Timers	<a href="http://www.ti.com/clocks">www.ti.com/clocks</a>
Interface	<a href="http://interface.ti.com">interface.ti.com</a>
Logic	<a href="http://logic.ti.com">logic.ti.com</a>
Power Mgmt	<a href="http://power.ti.com">power.ti.com</a>
Microcontrollers	<a href="http://microcontroller.ti.com">microcontroller.ti.com</a>
RFID	<a href="http://www.ti-rfid.com">www.ti-rfid.com</a>
RF/IF and ZigBee® Solutions	<a href="http://www.ti.com/lprf">www.ti.com/lprf</a>

### Applications

Communications and Telecom	<a href="http://www.ti.com/communications">www.ti.com/communications</a>
Computers and Peripherals	<a href="http://www.ti.com/computers">www.ti.com/computers</a>
Consumer Electronics	<a href="http://www.ti.com/consumer-apps">www.ti.com/consumer-apps</a>
Energy and Lighting	<a href="http://www.ti.com/energy">www.ti.com/energy</a>
Industrial	<a href="http://www.ti.com/industrial">www.ti.com/industrial</a>
Medical	<a href="http://www.ti.com/medical">www.ti.com/medical</a>
Security	<a href="http://www.ti.com/security">www.ti.com/security</a>
Space, Avionics and Defense	<a href="http://www.ti.com/space-avionics-defense">www.ti.com/space-avionics-defense</a>
Transportation and Automotive	<a href="http://www.ti.com/automotive">www.ti.com/automotive</a>
Video and Imaging	<a href="http://www.ti.com/video">www.ti.com/video</a>
Wireless	<a href="http://www.ti.com/wireless-apps">www.ti.com/wireless-apps</a>

TI E2E Community Home Page

[e2e.ti.com](http://e2e.ti.com)

Mailing Address: Texas Instruments, Post Office Box 655303, Dallas, Texas 75265  
Copyright © 2011, Texas Instruments Incorporated