

Low-Power BiCMOS Current-Mode PWM

FEATURES

- 100 μ A Typical Starting Supply Current
- 500 μ A Typical Operating Supply Current
- Operation to 1MHz
- Internal Soft Start
- Internal Fault Soft Start
- Internal Leading-Edge Blanking of the Current Sense Signal
- 1 Amp Totem-Pole Output
- 70ns Typical Response from Current-Sense to Gate Drive Output
- 1.5% Tolerance Voltage Reference
- Same Pinout as UC3842 and UC3842A

DESCRIPTION

The UCC1800/1/2/3/4/5 family of high-speed, low-power integrated circuits contain all of the control and drive components required for off-line and DC-to-DC fixed frequency current-mode switching power supplies with minimal parts count.

These devices have the same pin configuration as the UC1842/3/4/5 family, and also offer the added features of internal full-cycle soft start and internal leading-edge blanking of the current-sense input.

The UCC1800/1/2/3/4/5 family offers a variety of package options, temperature range options, choice of maximum duty cycle, and choice of critical voltage levels. Lower reference parts such as the UCC1803 and UCC1805 fit best into battery operated systems, while the higher reference and the higher UVLO hysteresis of the UCC1802 and UCC1804 make these ideal choices for use in off-line power supplies.

The UCC180x series is specified for operation from -55°C to $+125^{\circ}\text{C}$, the UCC280x series is specified for operation from -40°C to $+85^{\circ}\text{C}$, and the UCC380x series is specified for operation from 0°C to $+70^{\circ}\text{C}$.

Part Number	Maximum Duty Cycle	Reference Voltage	Turn-On Threshold	Turn-Off Threshold
UCCx800	100%	5V	7.2V	6.9V
UCCx801	50%	5V	9.4V	7.4V
UCCx802	100%	5V	12.5V	8.3V
UCCx803	100%	4V	4.1V	3.6V
UCCx804	50%	5V	12.5V	8.3V
UCCx805	50%	4V	4.1V	3.6V

BLOCK DIAGRAM

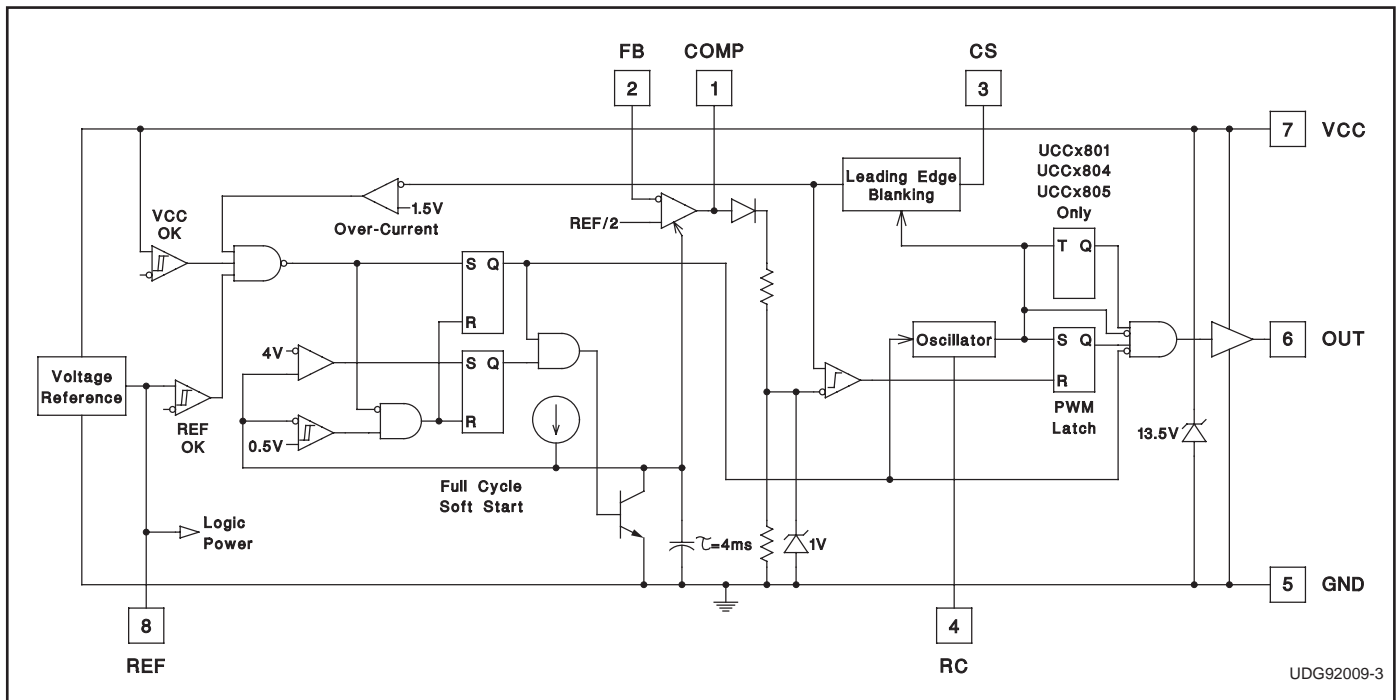

ABSOLUTE MAXIMUM RATINGS (Note 1)

V _{CC} Voltage (Note 2)	12.0V
V _{CC} Current (Note 2)	30.0mA
OUT Current	±1.0A
OUT Energy (Capacitive Load)	20.0μJ
Analog Inputs (FB, CS)	-0.3V to 6.3V
Power Dissipation at T _A < +25°C (N or J Package)	1.0W
Power Dissipation at T _A < +25°C (D Package)	0.65W
Power Dissipation at T _A < +25°C (L Package)	1.375W
Storage Temperature Range	-65°C to +150°C
Lead Temperature (Soldering, 10 Seconds)	+300°C

Note 1: Values beyond which damage may occur. All voltages are with respect to GND. All currents are positive into the specified terminal. Consult Unitrode databook for information regarding thermal specifications and limitations of packages.

Note 2: In normal operation V_{CC} is powered through a current limiting resistor. Absolute maximum of 12V applies when V_{CC} is driven from a low impedance source such that I_{CC} does not exceed 30mA (which includes gate drive current requirement).

TEMPERATURE AND PACKAGE SELECTION

	Temperature Range	Available Packages
UCC180X	-55°C to +125°C	J, L
UCC280X	-40°C to +85°C	N, D, PW
UCC380X	0°C to +70°C	N, D, PW

ORDERING INFORMATION

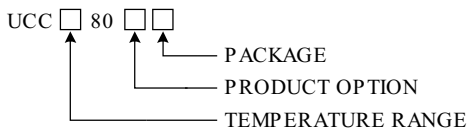

CONNECTION DIAGRAMS

TSSOP-8 (Top View) PW Package

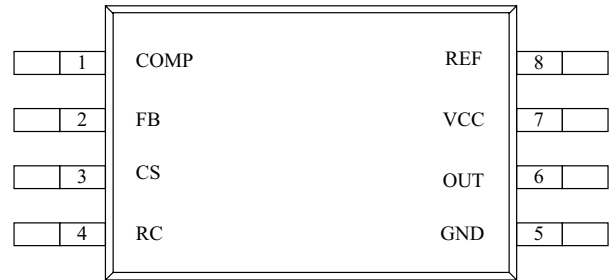

DIL-8, SOIC-8 (Top View) J or N, D Package

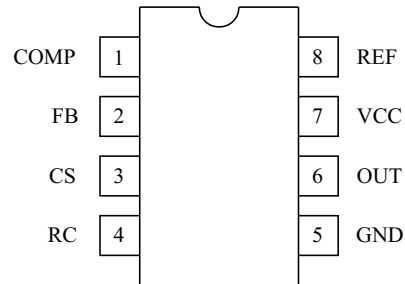

LCC-20 (TOP VIEW) L Package

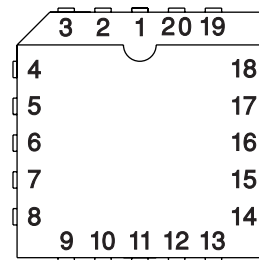

PACKAGE PIN FUNCTION	
FUNCTION	PIN
N/C	1
Comp	2
N/C	3-4
FB	5
N/C	6
CS	7
N/C	8-9
RC	10
N/C	11
PWR GND	12
GND	13
N/C	14
OUT	15
N/C	16
VCC	17
N/C	18-19
REF	20

ELECTRICAL CHARACTERISTICS Unless otherwise stated, these specifications apply for $-55^{\circ}\text{C} \leq T_A \leq +125^{\circ}\text{C}$ for UCC180x; $-40^{\circ}\text{C} \leq T_A \leq +85^{\circ}\text{C}$ for UCC280x; $0^{\circ}\text{C} \leq T_A \leq +70^{\circ}\text{C}$ for UCC380x; $V_{CC}=10\text{V}$ (Note 3); $R_T=100\text{k}$ from REF to RC; $C_T=330\text{pF}$ from RC to GND; 0.1 F capacitor from V_{CC} to GND; 0.1 F capacitor from V_{REF} to GND. $T_A=T_J$.

PARAMETER	TEST CONDITIONS	UCC180X UCC280X			UCC380X			UNITS
		MIN	TYP	MAX	MIN	TYP	MAX	
Reference Section								
Output Voltage	$T_J=+25^{\circ}\text{C}$, $I=0.2\text{mA}$, UCCx800/1/2/4	4.925	5.00	5.075	4.925	5.00	5.075	V
	$T_J=+25^{\circ}\text{C}$, $I=0.2\text{mA}$, UCCx803/5	3.94	4.00	4.06	3.94	4.00	4.06	
Load Regulation	$0.2\text{mA} < I < 5\text{mA}$		10	30		10	25	mV
Line Regulation	$T_J=+25^{\circ}\text{C}$, $V_{CC}=10\text{V}$ to Clamp ($I_{VCC}=25\text{mA}$)			1.9			1.9	mV/V
	$T_J=-55^{\circ}\text{C}$ to $+125^{\circ}\text{C}$, $V_{CC}=10\text{V}$ to Clamp ($I_{VCC}=25\text{mA}$)			2.5			2.1	mV/V
Total Variation	UCCx800/1/2/4 (Note 7)	4.88	5.00	5.10	4.88	5.00	5.10	V
	UCCx803/5 (Note 7)	3.90	4.00	4.08	3.90	4.00	4.08	V
Output Noise Voltage	$10\text{Hz} \leq f \leq 10\text{kHz}$, $T_J=+25^{\circ}\text{C}$ (Note 9)		130			130		μV
Long Term Stability	$T_A=+125^{\circ}\text{C}$, 1000 Hours (Note 9)		5			5		mV
Output Short Circuit		-5		-35	-5		-35	mA
Oscillator Section								
Oscillator Frequency	UCCx800/1/2/4 (Note 4)	40	46	52	40	46	52	kHz
	UCCx803/5 (Note 4)	26	31	36	26	31	36	
Temperature Stability	(Note 9)		2.5			2.5		%
Amplitude peak-to-peak		2.25	2.40	2.55	2.25	2.40	2.55	V
Oscillator Peak Voltage			2.45			2.45		V
Error Amplifier Section								
Input Voltage	COMP=2.5V; UCCx800/1/2/4	2.44	2.50	2.56	2.44	2.50	2.56	V
	COMP=2.0V; UCCx803/5	1.95	2.0	2.05	1.95	2.0	2.05	
Input Bias Current		-1		1	-1		1	μA
Open Loop Voltage Gain		60	80		60	80		dB
COMP Sink Current	FB=2.7V, COMP=1.1V	0.3		3.5	0.4		2.5	mA
COMP Source Current	FB=1.8V, COMP=REF-1.2V	-0.2	-0.5	-0.8	-0.2	-0.5	-0.8	mA
Gain Bandwidth Product	(Note 9)		2			2		MHz
PWM Section								
Maximum Duty Cycle	UCCx800/2/3	97	99	100	97	99	100	%
	UCCx801/4/5	48	49	50	48	49	50	
Minimum Duty Cycle	COMP=0V			0			0	%
Current Sense Section								
Gain	(Note 5)	1.10	1.65	1.80	1.10	1.65	1.80	V/V
Maximum Input Signal	COMP=5V (Note 6)	0.9	1.0	1.1	0.9	1.0	1.1	V
Input Bias Current		-200		200	-200		200	nA
CS Blank Time		50	100	150	50	100	150	ns
Over-Current Threshold		1.42	1.55	1.68	1.42	1.55	1.68	V
COMP to CS Offset	CS=0V	0.45	0.90	1.35	0.45	0.90	1.35	V
Output Section								

ELECTRICAL CHARACTERISTICS Unless otherwise stated, these specifications apply for $-55^{\circ}\text{C} \leq T_A \leq +125^{\circ}\text{C}$ for UCC180x; $-40^{\circ}\text{C} \leq T_A \leq +85^{\circ}\text{C}$ for UCC280x; $0^{\circ}\text{C} \leq T_A \leq +70^{\circ}\text{C}$ for UCC380x; $V_{CC}=10\text{V}$ (Note 3); $RT=100\text{k}$ from REF to RC; $CT=330\text{pF}$ from RC to GND; 0.1 F capacitor from V_{CC} to GND; 0.1 F capacitor from V_{REF} to GND. $T_A=T_J$.

PARAMETER	TEST CONDITIONS	UCC180X UCC280X			UCC380X			UNITS
OUT Low Level	I=20mA, all parts		0.1	0.4		0.1	0.4	V
	I=200mA, all parts		0.35	0.90		0.35	0.90	V
	I=50mA, VCC=5V, UCCx803/5		0.15	0.40		0.15	0.40	V
	I=20mA, VCC=0V, all parts		0.7	1.2		0.7	1.2	V
OUT High V _{SAT} (V _{CC} -OUT)	I=-20mA, all parts		0.15	0.40		0.15	0.40	V
	I=-200mA, all parts		1.0	1.9		1.0	1.9	V
	I=-50mA, VCC=5V, UCCx803/5		0.4	0.9		0.4	0.9	V
Rise Time	C _L =1nF		41	70		41	70	ns
Fall Time	C _L =1nF		44	75		44	75	ns
Undervoltage Lockout Section								
Start Threshold (Note 8)	UCCx800	6.6	7.2	7.8	6.6	7.2	7.8	V
	UCCx801	8.6	9.4	10.2	8.6	9.4	10.2	V
	UCCx802/4	11.5	12.5	13.5	11.5	12.5	13.5	V
	UCCx803/5	3.7	4.1	4.5	3.7	4.1	4.5	V
Stop Threshold (Note 8)	UCCx1800	6.3	6.9	7.5	6.3	6.9	7.5	V
	UCCx1801	6.8	7.4	8.0	6.8	7.4	8.0	V
	UCCx802/4	7.6	8.3	9.0	7.6	8.3	9.0	V
	UCCx803/5	3.2	3.6	4.0	3.2	3.6	4.0	V
Undervoltage Lockout Section (cont.)								
Start to Stop Hysteresis	UCCx800	0.12	0.3	0.48	0.12	0.3	0.48	V
	UCCx801	1.6	2	2.4	1.6	2	2.4	V
	UCCx802/4	3.5	4.2	5.1	3.5	4.2	5.1	V
	UCCx803/5	0.2	0.5	0.8	0.2	0.5	0.8	V
Soft Start Section								
COMP Rise Time	FB=1.8V, Rise from 0.5V to REF-1V		4	10		4	10	ms
Overall Section								
Start-up Current	V _{CC} < Start Threshold		0.1	0.2		0.1	0.2	mA
Operating Supply Current	FB=0V, CS=0V		0.5	1.0		0.5	1.0	mA
VCC Internal Zener Voltage	I _{CC} =10mA (Note 8), (Note 10)	12	13.5	15	12	13.5	15	V
VCC Internal Zener Voltage Minus Start Threshold Voltage	UCCx802/4 (Note 8)	0.5	1.0		0.5	1.0		V

Note 3: Adjust VCC above the start threshold before setting at 10V.

Note 4: Oscillator frequency for the UCCx800, UCCx802 and UCCx803 is the output frequency.

Oscillator frequency for the UCCx801, UCCx804 and UCCx805 is twice the output frequency.

Note 5: Gain is defined by: $A = \frac{\Delta V_{COMP}}{\Delta V_{CS}}$ $0 \leq V_{CS} \leq 0.8V$.

Note 6: Parameter measured at trip point of latch with Pin 2 at 0V.

Note 7: Total Variation includes temperature stability and load regulation.

Note 8: Start Threshold, Stop Threshold and Zener Shunt Thresholds track one another.

Note 9: Guaranteed by design. Not 100% tested in production.

Note 10: The device is fully operating in clamp mode as the forcing current is higher than the normal operating supply current.

PIN DESCRIPTIONS

COMP: COMP is the output of the error amplifier and the input of the PWM comparator.

Unlike other devices, the error amplifier in the UCC3800 family is a true, low output-impedance, 2MHz operational amplifier. As such, the COMP terminal can both source and sink current. However, the error amplifier is internally current limited, so that you can command zero duty cycle by externally forcing COMP to GND.

The UCC3800 family features built-in full cycle Soft Start. Soft Start is implemented as a clamp on the maximum COMP voltage.

CS: CS is the input to the current sense comparators. The UCC3800 family has two different current sense comparators: the PWM comparator and an over-current comparator.

The UCC3800 family contains digital current sense filtering, which disconnects the CS terminal from the current sense comparator during the 100ns interval immediately following the rising edge of the OUT pin. This digital filtering, also called leading-edge blanking, means that in most applications, no analog filtering (RC filter) is required on CS. Compared to an external RC filter technique, the leading-edge blanking provides a smaller effective CS to OUT propagation delay. Note, however, that the minimum non-zero On-Time of the OUT signal is directly affected by the leading-edge-blanking and the CS to OUT propagation delay.

The over-current comparator is only intended for fault sensing, and exceeding the over-current threshold will cause a soft start cycle.

FB: FB is the inverting input of the error amplifier. For best stability, keep FB lead length as short as possible and FB stray capacitance as small as possible.

GND: GND is reference ground and power ground for all functions on this part.

OUT: OUT is the output of a high-current power driver capable of driving the gate of a power MOSFET with peak currents exceeding $\pm 750\text{mA}$. OUT is actively held low when V_{CC} is below the UVLO threshold.

The high-current power driver consists of FET output devices, which can switch all of the way to GND and all of the way to V_{CC} . The output stage also provides a very low impedance to overshoot and undershoot. This means that in many cases, external schottky clamp diodes are not required.

RC: RC is the oscillator timing pin. For fixed frequency operation, set timing capacitor charging current by connecting a resistor from REF to RC. Set frequency by connecting a timing capacitor from RC to GND. For best

performance, keep the timing capacitor lead to GND as short and direct as possible. If possible, use separate ground traces for the timing capacitor and all other functions.

The frequency of oscillation can be estimated with the following equations:

$$\text{UCCx800/1/2/4: } F = \frac{1.5}{R \cdot C}$$

$$\text{UCCx803, UCCx805: } F = \frac{1.0}{R \cdot C}$$

where frequency is in Hz, resistance is in ohms, and capacitance is in farads. The recommended range of timing resistors is between 10k and 200k and timing capacitor is 100pF to 1000pF. Never use a timing resistor less than 10k.

To prevent noise problems, bypass V_{CC} to GND with a ceramic capacitor as close to the V_{CC} pin as possible. An electrolytic capacitor may also be used in addition to the ceramic capacitor.

REF: REF is the voltage reference for the error amplifier and also for many other functions on the IC. REF is also used as the logic power supply for high speed switching logic on the IC.

When V_{CC} is greater than 1V and less than the UVLO threshold, REF is pulled to ground through a 5k ohm resistor. This means that REF can be used as a logic output indicating power system status. It is important for reference stability that REF is bypassed to GND with a ceramic capacitor as close to the pin as possible. An electrolytic capacitor may also be used in addition to the ceramic capacitor. A minimum of 0.1 μF ceramic is required. Additional REF bypassing is required for external loads greater than 2.5mA on the reference.

To prevent noise problems with high speed switching transients, bypass REF to ground with a ceramic capacitor very close to the IC package.

VCC: V_{CC} is the power input connection for this device. In normal operation V_{CC} is powered through a current limiting resistor. Although quiescent V_{CC} current is very low, total supply current will be higher, depending on OUT current. Total V_{CC} current is the sum of quiescent V_{CC} current and the average OUT current. Knowing the operating frequency and the MOSFET gate charge (Q_g), average OUT current can be calculated from:

$$I_{OUT} = Q_g \times F.$$

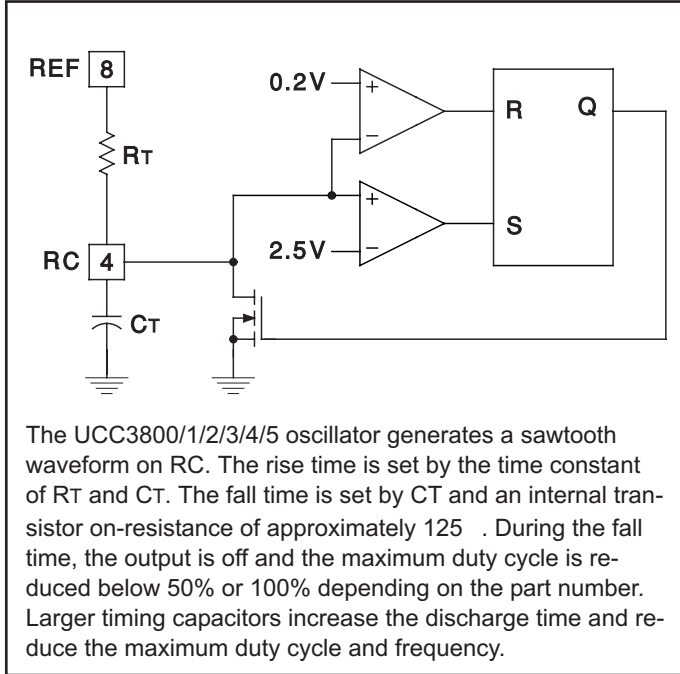

Figure 1. Oscillator.

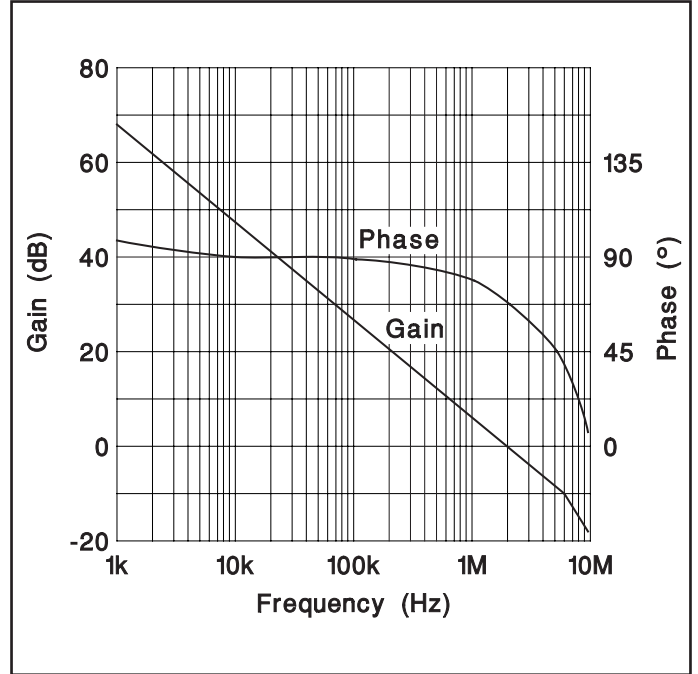

Figure 2. Error amplifier gain/phase response.

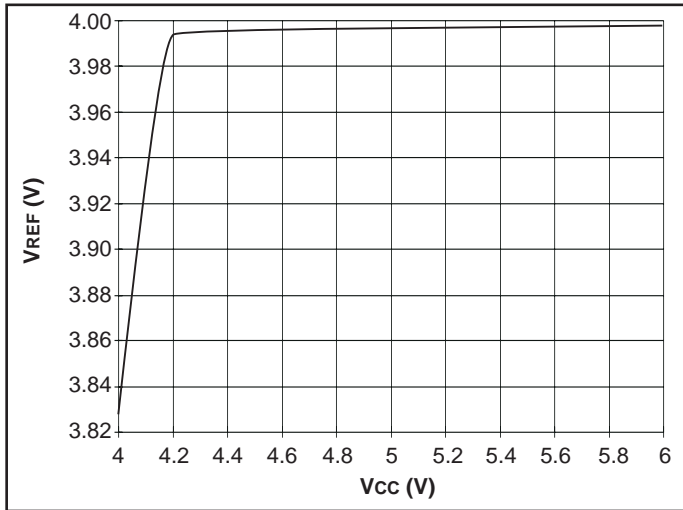

Figure 3. UCC1803/5 V_{REF} vs. V_{CC} ; $I_{LOAD} = 0.5mA$.

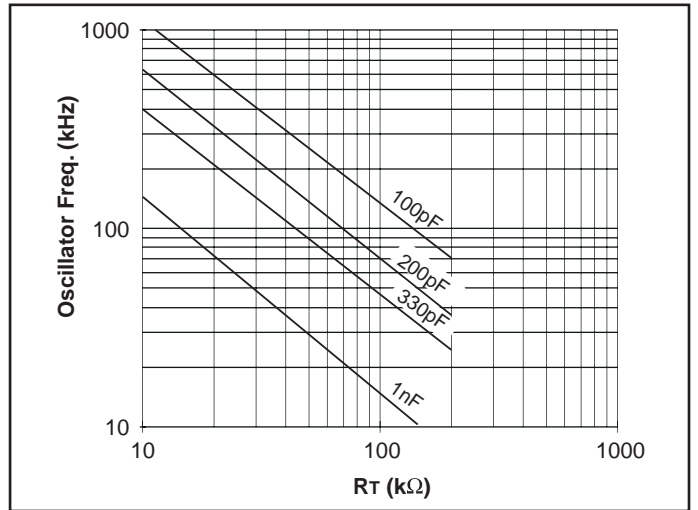

Figure 4. UCC1800/1/2/4 oscillator frequency vs. R_T and C_T .

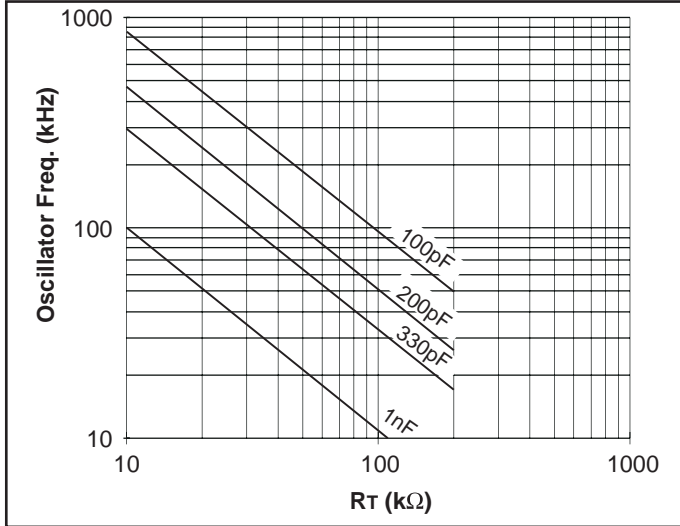

Figure 5. UCC1803/5 oscillator frequency vs. R_T and C_T .

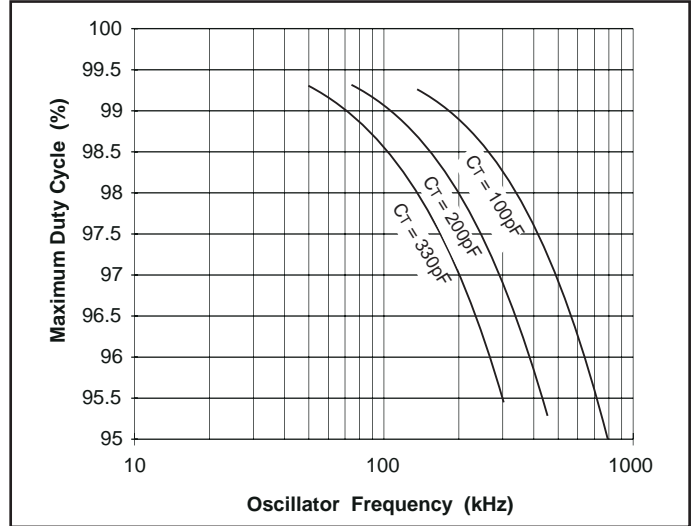

Figure 6. UCC1800/2/3 maximum duty cycle vs. oscillator frequency.

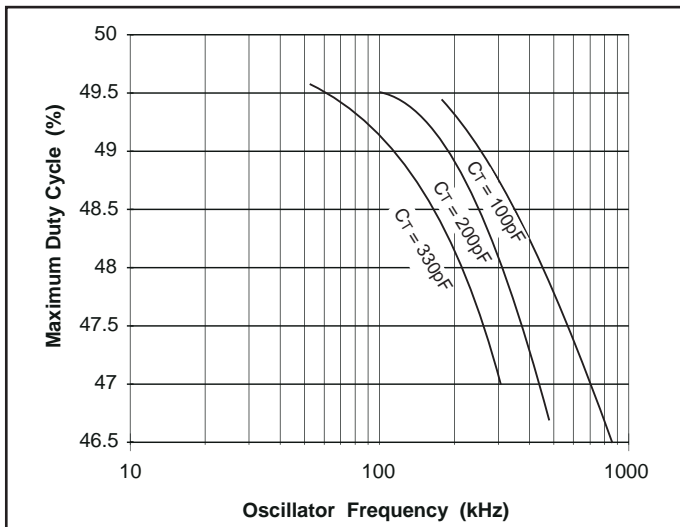

Figure 7. UCC1801/4/5 maximum duty cycle vs. oscillator frequency.

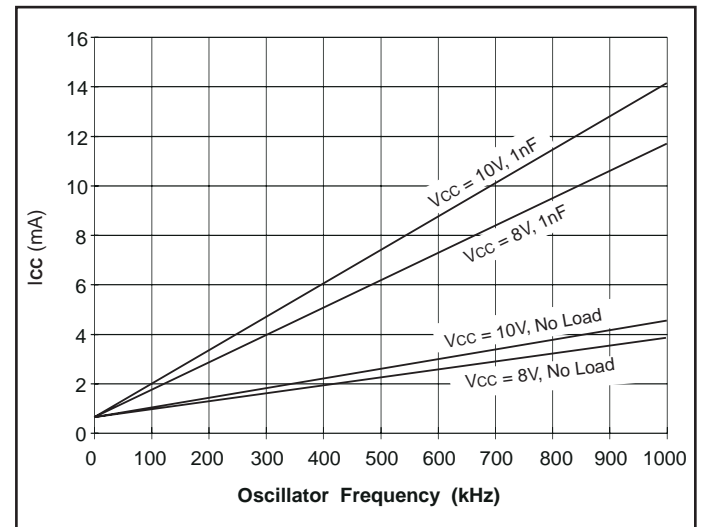

Figure 8. UCC1800 I_{CC} vs. oscillator frequency.

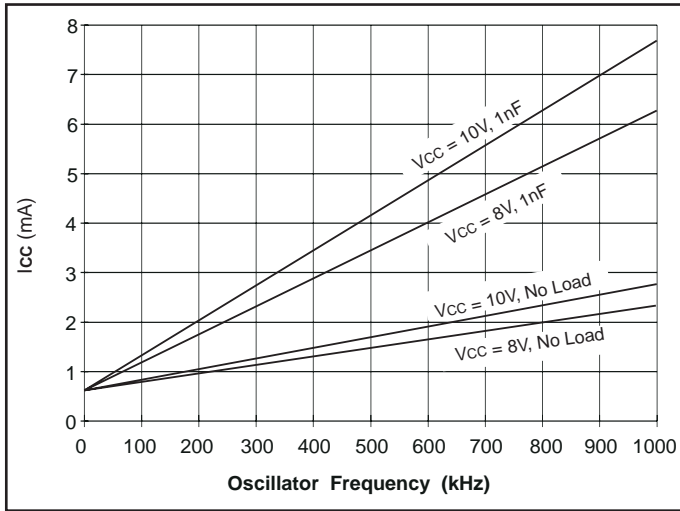

Figure 8. UCC1805 ICC vs. oscillator frequency.

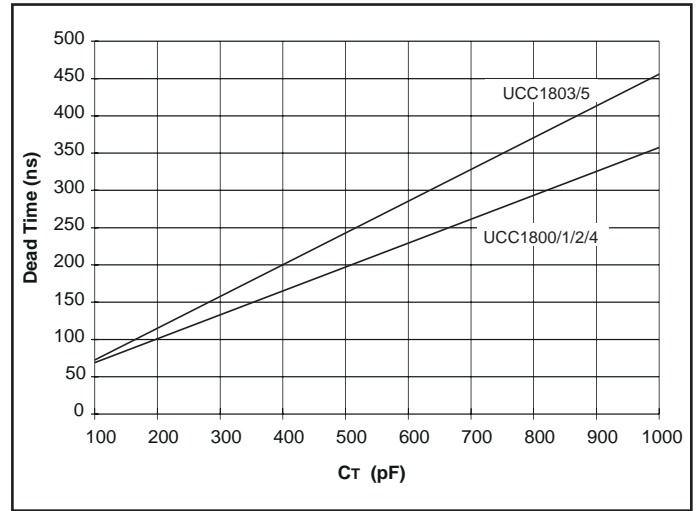

Figure 9. Dead time vs. C_T , $R_T = 100k$.

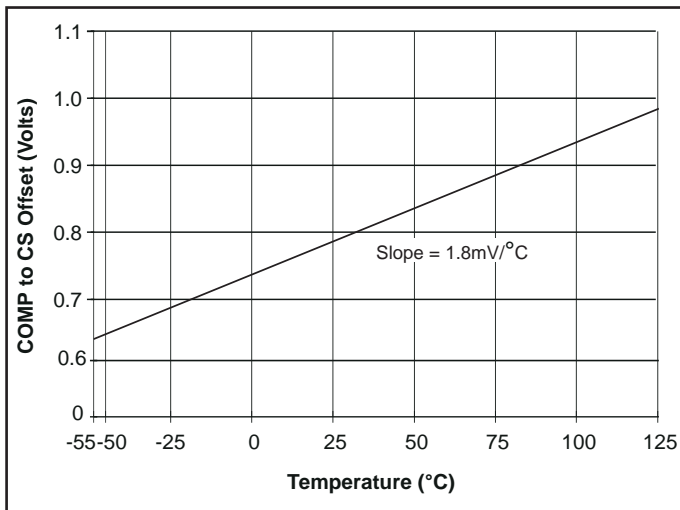

Figure 10. COMP to CS offset vs. temperature, CS = 0V.

CONTACT INFORMATION

If you should have any questions or wish additional information, please contact Jody Bustamante at (903) 868-6132 or e-mail at j-busta@ti.com.

IMPORTANT NOTICE

Texas Instruments Incorporated and its subsidiaries (TI) reserve the right to make corrections, modifications, enhancements, improvements, and other changes to its products and services at any time and to discontinue any product or service without notice. Customers should obtain the latest relevant information before placing orders and should verify that such information is current and complete. All products are sold subject to TI's terms and conditions of sale supplied at the time of order acknowledgment.

TI warrants performance of its hardware products to the specifications applicable at the time of sale in accordance with TI's standard warranty. Testing and other quality control techniques are used to the extent TI deems necessary to support this warranty. Except where mandated by government requirements, testing of all parameters of each product is not necessarily performed.

TI assumes no liability for applications assistance or customer product design. Customers are responsible for their products and applications using TI components. To minimize the risks associated with customer products and applications, customers should provide adequate design and operating safeguards.

TI does not warrant or represent that any license, either express or implied, is granted under any TI patent right, copyright, mask work right, or other TI intellectual property right relating to any combination, machine, or process in which TI products or services are used. Information published by TI regarding third-party products or services does not constitute a license from TI to use such products or services or a warranty or endorsement thereof. Use of such information may require a license from a third party under the patents or other intellectual property of the third party, or a license from TI under the patents or other intellectual property of TI.

Reproduction of information in TI data books or data sheets is permissible only if reproduction is without alteration and is accompanied by all associated warranties, conditions, limitations, and notices. Reproduction of this information with alteration is an unfair and deceptive business practice. TI is not responsible or liable for such altered documentation.

Resale of TI products or services with statements different from or beyond the parameters stated by TI for that product or service voids all express and any implied warranties for the associated TI product or service and is an unfair and deceptive business practice. TI is not responsible or liable for any such statements.

Following are URLs where you can obtain information on other Texas Instruments products and application solutions:

Products		Applications	
Amplifiers	amplifier.ti.com	Audio	www.ti.com/audio
Data Converters	dataconverter.ti.com	Automotive	www.ti.com/automotive
DSP	dsp.ti.com	Broadband	www.ti.com/broadband
Interface	interface.ti.com	Digital Control	www.ti.com/digitalcontrol
Logic	logic.ti.com	Military	www.ti.com/military
Power Mgmt	power.ti.com	Optical Networking	www.ti.com/opticalnetwork
Microcontrollers	microcontroller.ti.com	Security	www.ti.com/security
		Telephony	www.ti.com/telephony
		Video & Imaging	www.ti.com/video
		Wireless	www.ti.com/wireless

Mailing Address: Texas Instruments
Post Office Box 655303 Dallas, Texas 75265