

POSITIVE-VOLTAGE REGULATORS

 Check for Samples: [uA78M00 SERIES](#)

FEATURES

- 3-Terminal Regulators
- Output Current up to 500 mA
- No External Components
- Internal Thermal-Overload Protection
- High Power-Dissipation Capability
- Internal Short-Circuit Current Limiting
- Output Transistor Safe-Area Compensation

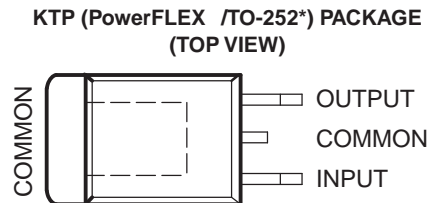
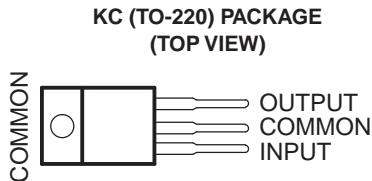

* Complies with JEDEC TO-252, variation AC

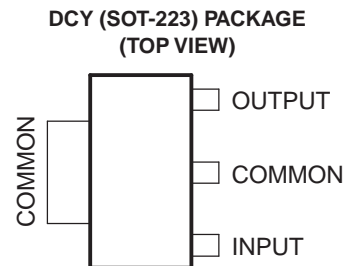
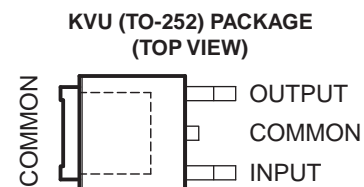
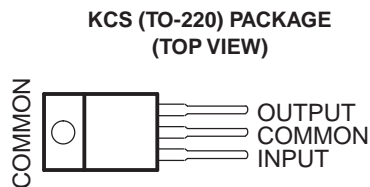

DESCRIPTION

This series of fixed-voltage integrated-circuit voltage regulators is designed for a wide range of applications. These applications include on-card regulation for elimination of noise and distribution problems associated with single-point regulation. Each of these regulators can deliver up to 500 mA of output current. The internal current-limiting and thermal-shutdown features of these regulators essentially make them immune to overload. In addition to use as fixed-voltage regulators, these devices can be used with external components to obtain adjustable output voltages and currents and also as the power-pass element in precision regulators.

ORDERING INFORMATION

For package and ordering information, see the Package Option Addendum at the end of this document.



Please be aware that an important notice concerning availability, standard warranty, and use in critical applications of Texas Instruments semiconductor products and disclaimers thereto appears at the end of this data sheet.

PowerPAD is a trademark of Texas Instruments.

PRODUCTION DATA information is current as of publication date. Products conform to specifications per the terms of the Texas Instruments standard warranty. Production processing does not necessarily include testing of all parameters.

Copyright © 1976–2013, Texas Instruments Incorporated

SCHEMATIC

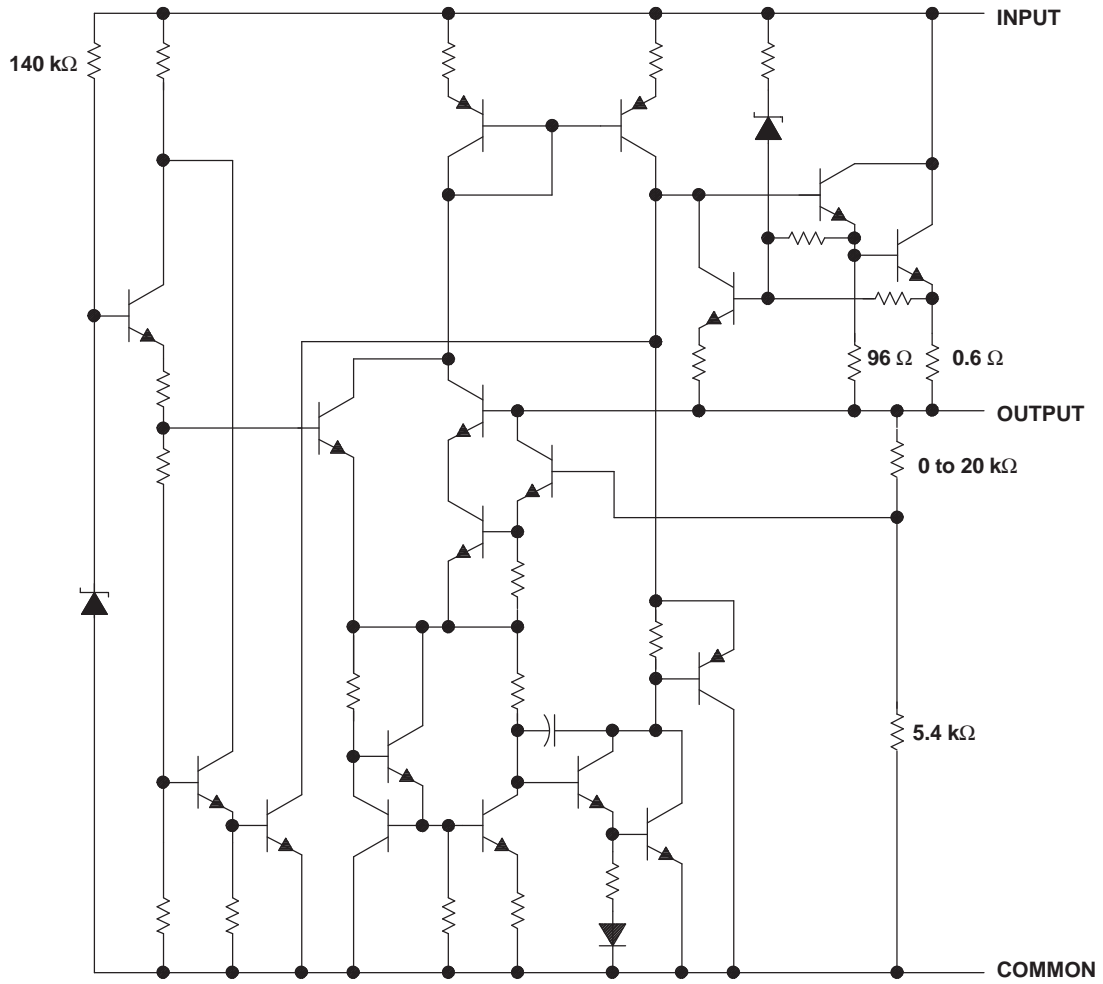

Resistor values shown are nominal.

Absolute Maximum Ratings⁽¹⁾

over virtual junction temperature range (unless otherwise noted)

		MIN	MAX	UNIT
V_I	Input voltage		35	V
T_J	Operating virtual junction temperature		150	°C
T_{stg}	Storage temperature range	-65	150	°C

- (1) Stresses beyond those listed under "absolute maximum ratings" may cause permanent damage to the device. These are stress ratings only, and functional operation of the device at these or any other conditions beyond those indicated under "recommended operating conditions" is not implied. Exposure to absolute-maximum-rated conditions for extended periods may affect device reliability.

Package Thermal Data⁽¹⁾

PACKAGE	BOARD	θ_{JP} ⁽²⁾	θ_{JC}	θ_{JA}
PowerFLEX/TO-252 – KTP	High K, JESD 51-5	1.4°C/W	19°C/W	28°C/W
SOT-223 – DCY	High K, JESD 51-7		30.6°C/W	53°C/W
TO-220 – KC	High K, JESD 51-5	3°C/W	17°C/W	19°C/W
TO-220 – KCS	High K, JESD 51-5	3°C/W	17°C/W	19°C/W
TO-252 – KVVU	High K, JESD 51-5			30.3°C/W

- (1) Maximum power dissipation is a function of $T_J(\max)$, θ_{JA} , and T_A . The maximum allowable power dissipation at any allowable ambient temperature is $P_D = (T_J(\max) - T_A)/\theta_{JA}$. Operating at the absolute maximum T_J of 150°C can affect reliability.
- (2) For packages with exposed thermal pads, such as QFN, PowerPAD™, or PowerFLEX, θ_{JP} is defined as the thermal resistance between the die junction and the bottom of the exposed pad.

Recommended Operating Conditions

		MIN	MAX	UNIT	
V_I	Input voltage	uA78M33	5.3	25	V
		uA78M05	7	25	
		uA78M06	8	25	
		uA78M08	10.5	25	
		uA78M09	11.5	26	
		uA78M10	12.5	28	
		uA78M12	14.5	30	
		uA78M15	17.5	30	
I_O	Output current		500	mA	
T_J	Operating virtual junction temperature	uA78MxxC	0	125	°C
		uA78MxxI	-40	125	

Electrical Characteristics

at specified virtual junction temperature, $V_I = 8\text{ V}$, $I_O = 350\text{ mA}$, $T_J = 25^\circ\text{C}$ (unless otherwise noted)

PARAMETER	TEST CONDITIONS ⁽¹⁾		uA78M33C			UNIT
			MIN	TYP	MAX	
Output voltage ⁽²⁾	$I_O = 5\text{ mA to }350\text{ mA}$, $V_I = 8\text{ V to }20\text{ V}$	$T_J = 0^\circ\text{C to }125^\circ\text{C}$	3.2	3.3	3.4	V
			3.1	3.3	3.5	
Input voltage regulation	$I_O = 200\text{ mA}$	$V_I = 5.3\text{ V to }25\text{ V}$		9	100	mV
		$V_I = 8\text{ V to }25\text{ V}$		3	50	
Ripple rejection	$V_I = 8\text{ V to }18\text{ V}$, $f = 120\text{ Hz}$	$I_O = 100\text{ mA}$, $T_J = 0^\circ\text{C to }125^\circ\text{C}$	62			dB
		$I_O = 300\text{ mA}$	62	80		
Output voltage regulation	$V_I = 8\text{ V}$,	$I_O = 5\text{ mA to }500\text{ mA}$		20	100	mV
Temperature coefficient of output voltage	$I_O = 5\text{ mA}$,	$T_J = 0^\circ\text{C to }125^\circ\text{C}$		-1		mV/°C
Output noise voltage	$f = 10\text{ Hz to }100\text{ kHz}$		40	200		µV
Dropout voltage				2		V
Bias current				4.5	6	mA
Bias current change	$I_O = 200\text{ mA}$, $V_I = 8\text{ V to }25\text{ V}$, $T_J = 0^\circ\text{C to }125^\circ\text{C}$				0.8	mA
	$I_O = 5\text{ mA to }350\text{ mA}$, $T_J = 0^\circ\text{C to }125^\circ\text{C}$				0.5	
Short-circuit output current	$V_I = 35\text{ V}$			300		mA
Peak output current				700		mA

- (1) All characteristics are measured with a 0.33-µF capacitor across the input and a 0.1-µF capacitor across the output. Pulse-testing techniques maintain T_J as close to T_A as possible. Thermal effects must be taken into account separately.
- (2) This specification applies only for dc power dissipation permitted by absolute maximum ratings

Electrical Characteristics

at specified virtual junction temperature, $V_I = 10\text{ V}$, $I_O = 350\text{ mA}$, $T_J = 25^\circ\text{C}$ (unless otherwise noted)

PARAMETER	TEST CONDITIONS ⁽¹⁾		uA78M05C			UNIT
			MIN	TYP	MAX	
Output voltage	$I_O = 5\text{ mA to }350\text{ mA}$, $V_I = 7\text{ V to }20\text{ V}$	$T_J = 0^\circ\text{C to }125^\circ\text{C}$	4.8	5	5.2	V
			4.75		5.25	
Input voltage regulation	$I_O = 200\text{ mA}$	$V_I = 7\text{ V to }25\text{ V}$		3	100	mV
		$V_I = 8\text{ V to }25\text{ V}$		1	50	
Ripple rejection	$V_I = 8\text{ V to }18\text{ V}$, $f = 120\text{ Hz}$	$I_O = 100\text{ mA}$, $T_J = 0^\circ\text{C to }125^\circ\text{C}$	62			dB
		$I_O = 300\text{ mA}$	62	80		
Output voltage regulation	$I_O = 5\text{ mA to }500\text{ mA}$			20	100	mV
	$I_O = 5\text{ mA to }200\text{ mA}$			10	50	
Temperature coefficient of output voltage	$I_O = 5\text{ mA}$,	$T_J = 0^\circ\text{C to }125^\circ\text{C}$		-1		mV/°C
Output noise voltage	$f = 10\text{ Hz to }100\text{ kHz}$		40	200		µV
Dropout voltage				2		V
Bias current				4.5	6	mA
Bias current change	$I_O = 200\text{ mA}$, $V_I = 8\text{ V to }25\text{ V}$, $T_J = 0^\circ\text{C to }125^\circ\text{C}$				0.8	mA
	$I_O = 5\text{ mA to }350\text{ mA}$, $T_J = 0^\circ\text{C to }125^\circ\text{C}$				0.5	
Short-circuit output current	$V_I = 35\text{ V}$			300		mA
Peak output current				0.7		A

- (1) All characteristics are measured with a 0.33-µF capacitor across the input and a 0.1-µF capacitor across the output. Pulse-testing techniques maintain T_J as close to T_A as possible. Thermal effects must be taken into account separately.

Electrical Characteristics

at specified virtual junction temperature, $V_I = 10\text{ V}$, $I_O = 350\text{ mA}$, $T_J = 25^\circ\text{C}$ (unless otherwise noted)

PARAMETER	TEST CONDITIONS ⁽¹⁾		uA78M05I			UNIT
			MIN	TYP	MAX	
Output voltage	$I_O = 5\text{ mA to }350\text{ mA}$, $V_I = 7\text{ V to }20\text{ V}$		4.8	5	5.2	V
		$T_J = -40^\circ\text{C to }125^\circ\text{C}$	4.75		5.25	
Input voltage regulation	$I_O = 200\text{ mA}$	$V_I = 7\text{ V to }25\text{ V}$		3	100	mV
		$V_I = 8\text{ V to }25\text{ V}$		1	50	
Ripple rejection	$V_I = 8\text{ V to }18\text{ V}$, $f = 120\text{ Hz}$	$I_O = 100\text{ mA}$, $T_J = -40^\circ\text{C to }125^\circ\text{C}$	62			dB
		$I_O = 300\text{ mA}$	62	80		
Output voltage regulation	$I_O = 5\text{ mA to }500\text{ mA}$			20	100	mV
	$I_O = 5\text{ mA to }200\text{ mA}$			10	50	
Temperature coefficient of output voltage	$I_O = 5\text{ mA}$,	$T_J = -40^\circ\text{C to }125^\circ\text{C}$		-1		mV/°C
Output noise voltage	$f = 10\text{ Hz to }100\text{ kHz}$			40	200	μV
Dropout voltage				2		V
Bias current				4.5	6	mA
Bias current change	$I_O = 200\text{ mA}$, $V_I = 8\text{ V to }25\text{ V}$, $T_J = -40^\circ\text{C to }125^\circ\text{C}$		0.8			mA
	$I_O = 5\text{ mA to }350\text{ mA}$, $T_J = -40^\circ\text{C to }125^\circ\text{C}$		0.5			
Short-circuit output current	$V_I = 35\text{ V}$		300			mA
Peak output current			0.7			A

(1) All characteristics are measured with a 0.33- μF capacitor across the input and a 0.1- μF capacitor across the output. Pulse-testing techniques maintain T_J as close to T_A as possible. Thermal effects must be taken into account separately.

Electrical Characteristics

at specified virtual junction temperature, $V_I = 11\text{ V}$, $I_O = 350\text{ mA}$, $T_J = 25^\circ\text{C}$ (unless otherwise noted)

PARAMETER	TEST CONDITIONS ⁽¹⁾		uA78M06C			UNIT	
			MIN	TYP	MAX		
Output voltage	$I_O = 5\text{ mA to }350\text{ mA}$,	$V_I = 8\text{ V to }21\text{ V}$		5.75	6	6.25	V
		$T_J = 0^\circ\text{C to }125^\circ\text{C}$		5.7		6.3	
Input voltage regulation	$I_O = 200\text{ mA}$	$V_I = 8\text{ V to }25\text{ V}$		5	100	mV	
		$V_I = 9\text{ V to }25\text{ V}$		1.5	50		
Ripple rejection	$V_I = 8\text{ V to }18\text{ V}$,	$f = 120\text{ Hz}$	$I_O = 100\text{ mA}$, $T_J = 0^\circ\text{C to }125^\circ\text{C}$	59			dB
			$I_O = 300\text{ mA}$	59	80		
Output voltage regulation	$I_O = 5\text{ mA to }500\text{ mA}$			20	120	mV	
	$I_O = 5\text{ mA to }200\text{ mA}$			10	60		
Temperature coefficient of output voltage	$I_O = 5\text{ mA}$,	$T_J = 0^\circ\text{C to }125^\circ\text{C}$		-1		mV/°C	
Output noise voltage	$f = 10\text{ Hz to }100\text{ kHz}$			45		μV	
Dropout voltage				2		V	
Bias current				4.5	6	mA	
Bias current change	$V_I = 9\text{ V to }25\text{ V}$, $I_O = 200\text{ mA}$, $T_J = 0^\circ\text{C to }125^\circ\text{C}$		0.8			mA	
	$I_O = 5\text{ mA to }350\text{ mA}$, $T_J = 0^\circ\text{C to }125^\circ\text{C}$		0.5				
Short-circuit output current	$V_I = 35\text{ V}$		270			mA	
Peak output current			0.7			A	

(1) All characteristics are measured with a 0.33- μF capacitor across the input and a 0.1- μF capacitor across the output. Pulse-testing techniques maintain T_J as close to T_A as possible. Thermal effects must be taken into account separately.

Electrical Characteristics

at specified virtual junction temperature, $V_I = 14\text{ V}$, $I_O = 350\text{ mA}$, $T_J = 25^\circ\text{C}$ (unless otherwise noted)

PARAMETER	TEST CONDITIONS ⁽¹⁾		uA78M08C			UNIT
			MIN	TYP	MAX	
Output voltage	$V_I = 10.5\text{ V to }23\text{ V}$, $I_O = 5\text{ mA to }350\text{ mA}$	$T_J = 0^\circ\text{C to }125^\circ\text{C}$	7.7	8	8.3	V
			7.6		8.4	
Input voltage regulation	$I_O = 200\text{ mA}$	$V_I = 10.5\text{ V to }25\text{ V}$	6	100	mV	
		$V_I = 11\text{ V to }25\text{ V}$	2	50		
Ripple rejection	$V_I = 11\text{ V to }21.5\text{ V}$, $f = 120\text{ Hz}$	$I_O = 100\text{ mA}$, $T_J = 0^\circ\text{C to }125^\circ\text{C}$	56		dB	
		$I_O = 300\text{ mA}$	56	80		
Output voltage regulation	$I_O = 5\text{ mA to }500\text{ mA}$		25	160	mV	
	$I_O = 5\text{ mA to }200\text{ mA}$		10	80		
Temperature coefficient of output voltage	$I_O = 5\text{ mA}$, $T_J = 0^\circ\text{C to }125^\circ\text{C}$		-1		mV/°C	
Output noise voltage	$f = 10\text{ Hz to }100\text{ kHz}$		52		μV	
Dropout voltage			2		V	
Bias current			4.6	6	mA	
Bias current change	$V_I = 10.5\text{ V to }25\text{ V}$, $I_O = 200\text{ mA}$, $T_J = 0^\circ\text{C to }125^\circ\text{C}$			0.8	mA	
	$I_O = 5\text{ mA to }350\text{ mA}$, $T_J = 0^\circ\text{C to }125^\circ\text{C}$			0.5		
Short-circuit output current	$V_I = 35\text{ V}$		250		mA	
Peak output current			0.7		A	

(1) All characteristics are measured with a 0.33-μF capacitor across the input and a 0.1-μF capacitor across the output. Pulse-testing techniques maintain T_J as close to T_A as possible. Thermal effects must be taken into account separately.

Electrical Characteristics

at specified virtual junction temperature, $V_I = 16\text{ V}$, $I_O = 350\text{ mA}$, $T_J = 25^\circ\text{C}$ (unless otherwise noted)

PARAMETER	TEST CONDITIONS ⁽¹⁾		uA78M09C			UNIT
			MIN	TYP	MAX	
Output voltage	$V_I = 11.5\text{ V to }24\text{ V}$, $I_O = 5\text{ mA to }350\text{ mA}$	$T_J = 0^\circ\text{C to }125^\circ\text{C}$	8.6	9	9.4	V
			8.5		9.5	
Input voltage regulation	$I_O = 200\text{ mA}$	$V_I = 11.5\text{ V to }26\text{ V}$	6	100	mV	
		$V_I = 12\text{ V to }26\text{ V}$	2	50		
Ripple rejection	$V_I = 13\text{ V to }23\text{ V}$, $f = 120\text{ Hz}$	$I_O = 100\text{ mA}$, $T_J = 0^\circ\text{C to }125^\circ\text{C}$	56		dB	
		$I_O = 300\text{ mA}$	56	80		
Output voltage regulation	$I_O = 5\text{ mA to }500\text{ mA}$		25	180	mV	
	$I_O = 5\text{ mA to }200\text{ mA}$		10	90		
Temperature coefficient of output voltage	$I_O = 5\text{ mA}$, $T_J = 0^\circ\text{C to }125^\circ\text{C}$		-1		mV/°C	
Output noise voltage	$f = 10\text{ Hz to }100\text{ kHz}$		58		μV	
Dropout voltage			2		V	
Bias current			4.6	6	mA	
Bias current change	$V_I = 11.5\text{ V to }26\text{ V}$, $I_O = 200\text{ mA}$, $T_J = 0^\circ\text{C to }125^\circ\text{C}$			0.8	mA	
	$I_O = 5\text{ mA to }350\text{ mA}$, $T_J = 0^\circ\text{C to }125^\circ\text{C}$			0.5		
Short-circuit output current	$V_I = 35\text{ V}$		250		mA	
Peak output current			0.7		A	

(1) All characteristics are measured with a 0.33-μF capacitor across the input and a 0.1-μF capacitor across the output. Pulse-testing techniques maintain T_J as close to T_A as possible. Thermal effects must be taken into account separately.

Electrical Characteristics

at specified virtual junction temperature, $V_I = 17\text{ V}$, $I_O = 350\text{ mA}$, $T_J = 25^\circ\text{C}$ (unless otherwise noted)

PARAMETER	TEST CONDITIONS ⁽¹⁾		uA78M10C			UNIT
			MIN	TYP	MAX	
Output voltage	$V_I = 12.5\text{ V to }25\text{ V}$,	$I_O = 5\text{ mA to }350\text{ mA}$	$T_J = 0^\circ\text{C to }125^\circ\text{C}$			V
			9.6	10	10.4	
Input voltage regulation	$I_O = 200\text{ mA}$	$V_I = 12.5\text{ V to }28\text{ V}$			mV	
		$V_I = 14\text{ V to }28\text{ V}$				
Ripple rejection	$V_I = 15\text{ V to }25\text{ V}$, $f = 120\text{ Hz}$	$I_O = 100\text{ mA}$, $I_O = 300\text{ mA}$	$T_J = 0^\circ\text{C to }125^\circ\text{C}$			dB
			59			
Output voltage regulation	$I_O = 5\text{ mA to }500\text{ mA}$		25 200			mV
	$I_O = 5\text{ mA to }200\text{ mA}$		10 100			
Temperature coefficient of output voltage	$I_O = 5\text{ mA}$,	$T_J = 0^\circ\text{C to }125^\circ\text{C}$			-1	mV/°C
Output noise voltage	$f = 10\text{ Hz to }100\text{ kHz}$		64			μV
Dropout voltage			2			V
Bias current			4.7 6			mA
Bias current change	$V_I = 12.5\text{ V to }28\text{ V}$,	$I_O = 200\text{ mA}$,	$T_J = 0^\circ\text{C to }125^\circ\text{C}$			mA
	$I_O = 5\text{ mA to }350\text{ mA}$,	$T_J = 0^\circ\text{C to }125^\circ\text{C}$	0.8			
Short-circuit output current	$V_I = 35\text{ V}$		245			mA
Peak output current			0.7			A

(1) All characteristics are measured with a 0.33-μF capacitor across the input and a 0.1-μF capacitor across the output. Pulse-testing techniques maintain T_J as close to T_A as possible. Thermal effects must be taken into account separately.

Electrical Characteristics

at specified virtual junction temperature, $V_I = 19\text{ V}$, $I_O = 350\text{ mA}$, $T_J = 25^\circ\text{C}$ (unless otherwise noted)

PARAMETER	TEST CONDITIONS ⁽¹⁾		uA78M12C			UNIT
			MIN	TYP	MAX	
Output voltage	$V_I = 14.5\text{ V to }27\text{ V}$,	$I_O = 5\text{ mA to }350\text{ mA}$	$T_J = 0^\circ\text{C to }125^\circ\text{C}$			V
			11.5	12	12.5	
Input voltage regulation	$I_O = 200\text{ mA}$	$V_I = 14.5\text{ V to }30\text{ V}$			mV	
		$V_I = 16\text{ V to }30\text{ V}$				
Ripple rejection	$V_I = 15\text{ V to }25\text{ V}$, $f = 120\text{ Hz}$	$I_O = 100\text{ mA}$, $I_O = 300\text{ mA}$	$T_J = 0^\circ\text{C to }125^\circ\text{C}$			dB
			55			
Output voltage regulation	$I_O = 5\text{ mA to }500\text{ mA}$		25 240			mV
	$I_O = 5\text{ mA to }200\text{ mA}$		10 120			
Temperature coefficient of output voltage	$I_O = 5\text{ mA}$,	$T_J = 0^\circ\text{C to }125^\circ\text{C}$			-1	mV/°C
Output noise voltage	$f = 10\text{ Hz to }100\text{ kHz}$		75			μV
Dropout voltage			2			V
Bias current			4.8 6			mA
Bias current change	$V_I = 14.5\text{ V to }30\text{ V}$,	$I_O = 200\text{ mA}$,	$T_J = 0^\circ\text{C to }125^\circ\text{C}$			mA
	$I_O = 5\text{ mA to }350\text{ mA}$,	$T_J = 0^\circ\text{C to }125^\circ\text{C}$	0.8			
Short-circuit output current	$V_I = 35\text{ V}$		240			mA
Peak output current			0.7			A

(1) All characteristics are measured with a 0.33-μF capacitor across the input and a 0.1-μF capacitor across the output. Pulse-testing techniques maintain T_J as close to T_A as possible. Thermal effects must be taken into account separately.

REVISION HISTORY

Changes from Revision Q (April 2010) to Revision R Page

- Removed obsolete part information from document. 1
-

Changes from Revision R (February 2013) to Revision S Page

- Removed ordering information table. 1
-

PACKAGING INFORMATION

Orderable Device	Status (1)	Package Type	Package Drawing	Pins	Package Qty	Eco Plan (2)	Lead/Ball Finish	MSL Peak Temp (3)	Op Temp (°C)	Device Marking (4/5)	Samples
UA78M05CDCY	ACTIVE	SOT-223	DCY	4	80	Green (RoHS & no Sb/Br)	CU SN	Level-2-260C-1 YEAR	0 to 125	C5	Samples
UA78M05CDCYG3	ACTIVE	SOT-223	DCY	4	80	Green (RoHS & no Sb/Br)	CU SN	Level-2-260C-1 YEAR	0 to 125	C5	Samples
UA78M05CDCYR	ACTIVE	SOT-223	DCY	4	2500	Green (RoHS & no Sb/Br)	CU SN	Level-2-260C-1 YEAR	0 to 125	C5	Samples
UA78M05CDCYRG3	ACTIVE	SOT-223	DCY	4	2500	Green (RoHS & no Sb/Br)	CU SN	Level-2-260C-1 YEAR	0 to 125	C5	Samples
UA78M05CKC	OBSOLETE	TO-220	KC	3		TBD	Call TI	Call TI	0 to 125	UA78M05C	
UA78M05CKCS	ACTIVE	TO-220	KCS	3	50	Pb-Free (RoHS)	CU SN	N / A for Pkg Type	0 to 125	UA78M05C	Samples
UA78M05CKCSE3	ACTIVE	TO-220	KCS	3	50	Pb-Free (RoHS)	CU SN	N / A for Pkg Type	0 to 125	UA78M05C	Samples
UA78M05CKTPR	OBSOLETE	PFM	KTP	2		TBD	Call TI	Call TI	0 to 125	UA78M05C	
UA78M05CKTPRG3	OBSOLETE	PFM	KTP	2		TBD	Call TI	Call TI	0 to 125	UA78M05C	
UA78M05CKVURG3	ACTIVE	TO-252	KVU	3	2500	Green (RoHS & no Sb/Br)	CU SN	Level-3-260C-168 HR	0 to 125	78M05C	Samples
UA78M05IDCY	ACTIVE	SOT-223	DCY	4	80	Green (RoHS & no Sb/Br)	CU SN	Level-2-260C-1 YEAR	-40 to 125	J5	Samples
UA78M05IDCYG3	ACTIVE	SOT-223	DCY	4	80	Green (RoHS & no Sb/Br)	CU SN	Level-2-260C-1 YEAR	-40 to 125	J5	Samples
UA78M05IDCYR	ACTIVE	SOT-223	DCY	4	2500	Green (RoHS & no Sb/Br)	CU SN	Level-2-260C-1 YEAR	-40 to 125	J5	Samples
UA78M05IDCYRG3	ACTIVE	SOT-223	DCY	4	2500	Green (RoHS & no Sb/Br)	CU SN	Level-2-260C-1 YEAR	-40 to 125	J5	Samples
UA78M05IKC	OBSOLETE	TO-220	KC	3		TBD	Call TI	Call TI	-40 to 125	UA78M05I	
UA78M05IKCE3	OBSOLETE	TO-220	KC	3		TBD	Call TI	Call TI	-40 to 125	UA78M05I	
UA78M05IKCS	ACTIVE	TO-220	KCS	3	50	Pb-Free (RoHS)	CU SN	N / A for Pkg Type	-40 to 125	UA78M05I	Samples
UA78M05IKCSE3	ACTIVE	TO-220	KCS	3	50	Pb-Free (RoHS)	CU SN	N / A for Pkg Type	-40 to 125	UA78M05I	Samples
UA78M05IKTPR	OBSOLETE	PFM	KTP	2		TBD	Call TI	Call TI	-40 to 125	UA78M05I	
UA78M05IKTPRG3	OBSOLETE	PFM	KTP	2		TBD	Call TI	Call TI	-40 to 125	UA78M05I	

Orderable Device	Status (1)	Package Type	Package Drawing	Pins	Package Qty	Eco Plan (2)	Lead/Ball Finish	MSL Peak Temp (3)	Op Temp (°C)	Device Marking (4/5)	Samples
UA78M05IKVURG3	ACTIVE	TO-252	KVU	3	2500	Green (RoHS & no Sb/Br)	CU SN	Level-3-260C-168 HR	-40 to 125	78M05I	Samples
UA78M06CKC	OBSOLETE	TO-220	KC	3		TBD	Call TI	Call TI	0 to 125		
UA78M06CKTPR	OBSOLETE	PFM	KTP	2		TBD	Call TI	Call TI	0 to 125	UA78M06C	
UA78M06CKTPRG3	OBSOLETE	PFM	KTP	2		TBD	Call TI	Call TI	0 to 125	UA78M06C	
UA78M06CKVURG3	ACTIVE	TO-252	KVU	3	2500	Green (RoHS & no Sb/Br)	CU SN	Level-3-260C-168 HR	0 to 125	78M06C	Samples
UA78M08CDCY	ACTIVE	SOT-223	DCY	4	80	Green (RoHS & no Sb/Br)	CU SN	Level-2-260C-1 YEAR	0 to 125	C8	Samples
UA78M08CDCYG3	ACTIVE	SOT-223	DCY	4	80	Green (RoHS & no Sb/Br)	CU SN	Level-2-260C-1 YEAR	0 to 125	C8	Samples
UA78M08CDCYR	ACTIVE	SOT-223	DCY	4	2500	Green (RoHS & no Sb/Br)	CU SN	Level-2-260C-1 YEAR	0 to 125	C8	Samples
UA78M08CDCYRG3	ACTIVE	SOT-223	DCY	4	2500	Green (RoHS & no Sb/Br)	CU SN	Level-2-260C-1 YEAR	0 to 125	C8	Samples
UA78M08CKC	OBSOLETE	TO-220	KC	3		TBD	Call TI	Call TI	0 to 125	UA78M08C	
UA78M08CKCE3	OBSOLETE	TO-220	KC	3		TBD	Call TI	Call TI	0 to 125	UA78M08C	
UA78M08CKCS	ACTIVE	TO-220	KCS	3	50	Pb-Free (RoHS)	CU SN	N / A for Pkg Type	0 to 125	UA78M08C	Samples
UA78M08CKCSE3	ACTIVE	TO-220	KCS	3	50	Pb-Free (RoHS)	CU SN	N / A for Pkg Type	0 to 125	UA78M08C	Samples
UA78M08CKTPR	OBSOLETE	PFM	KTP	2		TBD	Call TI	Call TI	0 to 125	UA78M08C	
UA78M08CKTPRG3	OBSOLETE	PFM	KTP	2		TBD	Call TI	Call TI	0 to 125	UA78M08C	
UA78M08CKVURG3	ACTIVE	TO-252	KVU	3	2500	Green (RoHS & no Sb/Br)	CU SN	Level-3-260C-168 HR	0 to 125	78M08C	Samples
UA78M09CKC	OBSOLETE	TO-220	KC	3		TBD	Call TI	Call TI	0 to 125		
UA78M09CKTP	OBSOLETE	PFM	KTP	2		TBD	Call TI	Call TI	0 to 125		
UA78M09CKTPR	OBSOLETE	PFM	KTP	2		TBD	Call TI	Call TI	0 to 125	UA78M09C	
UA78M09CKTPRG3	OBSOLETE	PFM	KTP	2		TBD	Call TI	Call TI	0 to 125	UA78M09C	
UA78M09CKVURG3	ACTIVE	TO-252	KVU	3	2500	Green (RoHS & no Sb/Br)	CU SN	Level-3-260C-168 HR	0 to 125	78M09C	Samples
UA78M10CKC	OBSOLETE	TO-220	KC	3		TBD	Call TI	Call TI	0 to 125		
UA78M10CKTPR	OBSOLETE	PFM	KTP	2		TBD	Call TI	Call TI	0 to 125	UA78M10C	
UA78M10CKTPRG3	OBSOLETE	PFM	KTP	2		TBD	Call TI	Call TI	0 to 125	UA78M10C	

Orderable Device	Status (1)	Package Type	Package Drawing	Pins	Package Qty	Eco Plan (2)	Lead/Ball Finish	MSL Peak Temp (3)	Op Temp (°C)	Device Marking (4/5)	Samples
UA78M10CKVURG3	ACTIVE	TO-252	KVU	3	2500	Green (RoHS & no Sb/Br)	CU SN	Level-3-260C-168 HR	0 to 125	78M10C	Samples
UA78M12CKC	OBSOLETE	TO-220	KC	3		TBD	Call TI	Call TI	0 to 125	UA78M12C	
UA78M12CKCS	ACTIVE	TO-220	KCS	3	50	Pb-Free (RoHS)	CU SN	N / A for Pkg Type	0 to 125	UA78M12C	Samples
UA78M12CKCSE3	ACTIVE	TO-220	KCS	3	50	Pb-Free (RoHS)	CU SN	N / A for Pkg Type	0 to 125	UA78M12C	Samples
UA78M12CKTPR	OBSOLETE	PFM	KTP	2		TBD	Call TI	Call TI	0 to 125	UA78M12C	
UA78M12CKTPRG3	OBSOLETE	PFM	KTP	2		TBD	Call TI	Call TI	0 to 125	UA78M12C	
UA78M12CKVURG3	ACTIVE	TO-252	KVU	3	2500	Green (RoHS & no Sb/Br)	CU SN	Level-3-260C-168 HR	0 to 125	78M12C	Samples
UA78M33CDCY	ACTIVE	SOT-223	DCY	4	80	Green (RoHS & no Sb/Br)	CU SN	Level-2-260C-1 YEAR	0 to 125	C3	Samples
UA78M33CDCYG3	ACTIVE	SOT-223	DCY	4	80	Green (RoHS & no Sb/Br)	CU SN	Level-2-260C-1 YEAR	0 to 125	C3	Samples
UA78M33CDCYR	ACTIVE	SOT-223	DCY	4	2500	Green (RoHS & no Sb/Br)	CU SN	Level-2-260C-1 YEAR	0 to 125	C3	Samples
UA78M33CDCYRG3	ACTIVE	SOT-223	DCY	4	2500	Green (RoHS & no Sb/Br)	CU SN	Level-2-260C-1 YEAR	0 to 125	C3	Samples
UA78M33CKC	OBSOLETE	TO-220	KC	3		TBD	Call TI	Call TI	0 to 125	UA78M33C	
UA78M33CKCE3	OBSOLETE	TO-220	KC	3		TBD	Call TI	Call TI	0 to 125	UA78M33C	
UA78M33CKCS	ACTIVE	TO-220	KCS	3	50	Pb-Free (RoHS)	CU SN	N / A for Pkg Type	0 to 125	UA78M33C	Samples
UA78M33CKCSE3	ACTIVE	TO-220	KCS	3	50	Pb-Free (RoHS)	CU SN	N / A for Pkg Type	0 to 125	UA78M33C	Samples
UA78M33CKTPR	OBSOLETE	PFM	KTP	2		TBD	Call TI	Call TI	0 to 125	UA78M33C	
UA78M33CKTPRG3	OBSOLETE	PFM	KTP	2		TBD	Call TI	Call TI	0 to 125	UA78M33C	
UA78M33CKVURG3	ACTIVE	TO-252	KVU	3	2500	Green (RoHS & no Sb/Br)	CU SN	Level-3-260C-168 HR	0 to 125	78M33C	Samples

(1) The marketing status values are defined as follows:

ACTIVE: Product device recommended for new designs.

LIFEBUY: TI has announced that the device will be discontinued, and a lifetime-buy period is in effect.

NRND: Not recommended for new designs. Device is in production to support existing customers, but TI does not recommend using this part in a new design.

PREVIEW: Device has been announced but is not in production. Samples may or may not be available.

OBSOLETE: TI has discontinued the production of the device.

⁽²⁾ Eco Plan - The planned eco-friendly classification: Pb-Free (RoHS), Pb-Free (RoHS Exempt), or Green (RoHS & no Sb/Br) - please check <http://www.ti.com/productcontent> for the latest availability information and additional product content details.

TBD: The Pb-Free/Green conversion plan has not been defined.

Pb-Free (RoHS): TI's terms "Lead-Free" or "Pb-Free" mean semiconductor products that are compatible with the current RoHS requirements for all 6 substances, including the requirement that lead not exceed 0.1% by weight in homogeneous materials. Where designed to be soldered at high temperatures, TI Pb-Free products are suitable for use in specified lead-free processes.

Pb-Free (RoHS Exempt): This component has a RoHS exemption for either 1) lead-based flip-chip solder bumps used between the die and package, or 2) lead-based die adhesive used between the die and leadframe. The component is otherwise considered Pb-Free (RoHS compatible) as defined above.

Green (RoHS & no Sb/Br): TI defines "Green" to mean Pb-Free (RoHS compatible), and free of Bromine (Br) and Antimony (Sb) based flame retardants (Br or Sb do not exceed 0.1% by weight in homogeneous material)

⁽³⁾ MSL, Peak Temp. -- The Moisture Sensitivity Level rating according to the JEDEC industry standard classifications, and peak solder temperature.

⁽⁴⁾ There may be additional marking, which relates to the logo, the lot trace code information, or the environmental category on the device.

⁽⁵⁾ Multiple Device Markings will be inside parentheses. Only one Device Marking contained in parentheses and separated by a "~" will appear on a device. If a line is indented then it is a continuation of the previous line and the two combined represent the entire Device Marking for that device.

Important Information and Disclaimer: The information provided on this page represents TI's knowledge and belief as of the date that it is provided. TI bases its knowledge and belief on information provided by third parties, and makes no representation or warranty as to the accuracy of such information. Efforts are underway to better integrate information from third parties. TI has taken and continues to take reasonable steps to provide representative and accurate information but may not have conducted destructive testing or chemical analysis on incoming materials and chemicals. TI and TI suppliers consider certain information to be proprietary, and thus CAS numbers and other limited information may not be available for release.

In no event shall TI's liability arising out of such information exceed the total purchase price of the TI part(s) at issue in this document sold by TI to Customer on an annual basis.

OTHER QUALIFIED VERSIONS OF UA78M05, UA78M10, UA78M33 :

- Automotive: [UA78M05-Q1](#), [UA78M10-Q1](#), [UA78M33-Q1](#)

NOTE: Qualified Version Definitions:

- Automotive - Q100 devices qualified for high-reliability automotive applications targeting zero defects

DCY (R-PDSO-G4)

PLASTIC SMALL-OUTLINE

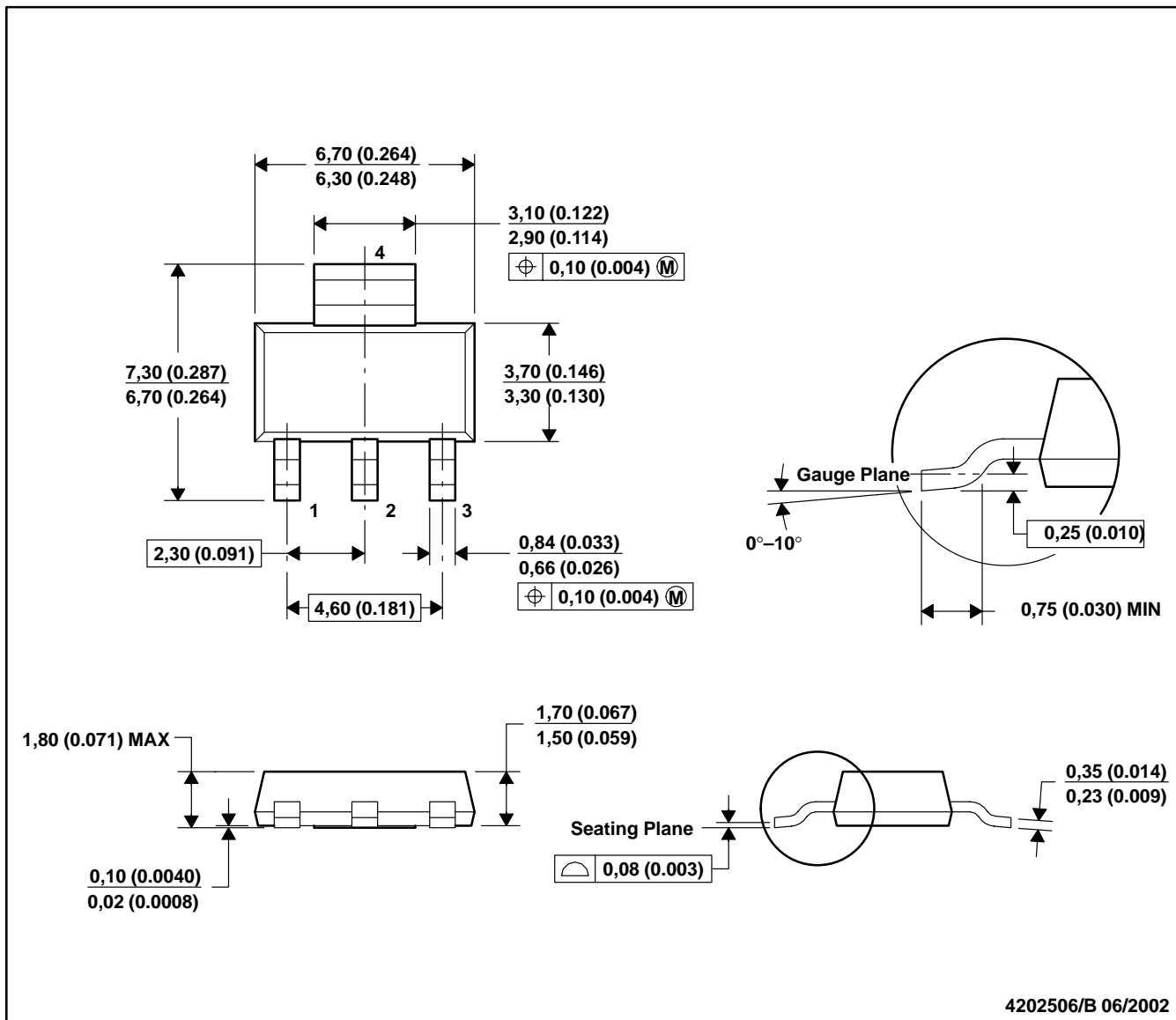

- NOTES: A. All linear dimensions are in millimeters (inches).
 B. This drawing is subject to change without notice.
 C. Body dimensions do not include mold flash or protrusion.
 D. Falls within JEDEC TO-261 Variation AA.

KTP (R-PSFM-G2)

PowerFLEX™ PLASTIC FLANGE-MOUNT PACKAGE

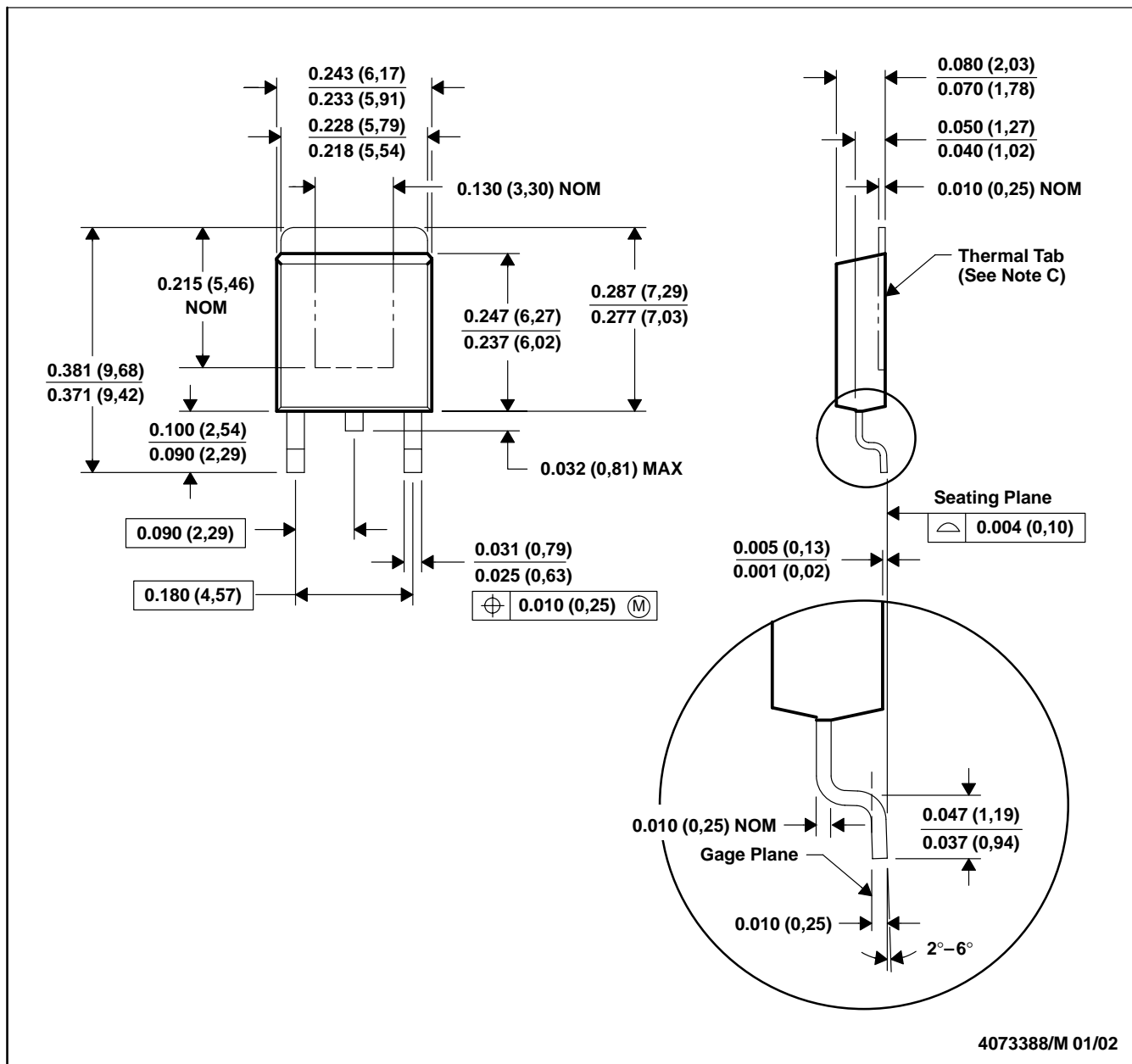

- NOTES: A. All linear dimensions are in inches (millimeters).
 B. This drawing is subject to change without notice.
 C. The center lead is in electrical contact with the thermal tab.
 D. Dimensions do not include mold protrusions, not to exceed 0.006 (0,15).
 E. Falls within JEDEC TO-252 variation AC.

PowerFLEX is a trademark of Texas Instruments.



MECHANICAL DATA

KVU (R-PSFM-G3)

PLASTIC FLANGE-MOUNT PACKAGE

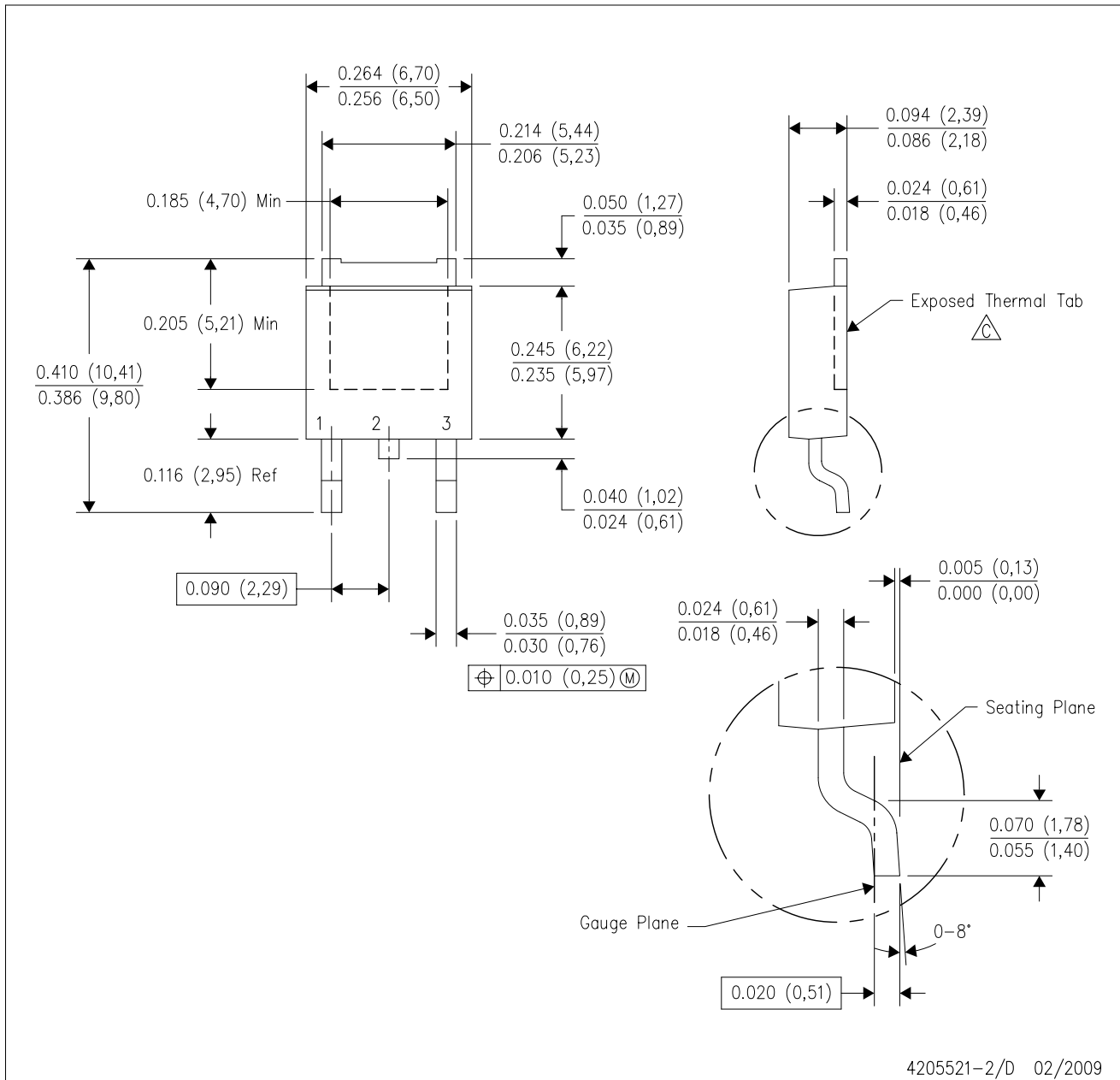

- NOTES:
- A. All linear dimensions are in inches (millimeters).
 - B. This drawing is subject to change without notice.
 -  The center lead is in electrical contact with the exposed thermal tab.
 - D. Body Dimensions do not include mold flash or protrusions. Mold flash and protrusion shall not exceed 0.006 (0,15) per side.
 - E. Falls within JEDEC TO-252 variation AA.

IMPORTANT NOTICE

Texas Instruments Incorporated and its subsidiaries (TI) reserve the right to make corrections, enhancements, improvements and other changes to its semiconductor products and services per JESD46, latest issue, and to discontinue any product or service per JESD48, latest issue. Buyers should obtain the latest relevant information before placing orders and should verify that such information is current and complete. All semiconductor products (also referred to herein as "components") are sold subject to TI's terms and conditions of sale supplied at the time of order acknowledgment.

TI warrants performance of its components to the specifications applicable at the time of sale, in accordance with the warranty in TI's terms and conditions of sale of semiconductor products. Testing and other quality control techniques are used to the extent TI deems necessary to support this warranty. Except where mandated by applicable law, testing of all parameters of each component is not necessarily performed.

TI assumes no liability for applications assistance or the design of Buyers' products. Buyers are responsible for their products and applications using TI components. To minimize the risks associated with Buyers' products and applications, Buyers should provide adequate design and operating safeguards.

TI does not warrant or represent that any license, either express or implied, is granted under any patent right, copyright, mask work right, or other intellectual property right relating to any combination, machine, or process in which TI components or services are used. Information published by TI regarding third-party products or services does not constitute a license to use such products or services or a warranty or endorsement thereof. Use of such information may require a license from a third party under the patents or other intellectual property of the third party, or a license from TI under the patents or other intellectual property of TI.

Reproduction of significant portions of TI information in TI data books or data sheets is permissible only if reproduction is without alteration and is accompanied by all associated warranties, conditions, limitations, and notices. TI is not responsible or liable for such altered documentation. Information of third parties may be subject to additional restrictions.

Resale of TI components or services with statements different from or beyond the parameters stated by TI for that component or service voids all express and any implied warranties for the associated TI component or service and is an unfair and deceptive business practice. TI is not responsible or liable for any such statements.

Buyer acknowledges and agrees that it is solely responsible for compliance with all legal, regulatory and safety-related requirements concerning its products, and any use of TI components in its applications, notwithstanding any applications-related information or support that may be provided by TI. Buyer represents and agrees that it has all the necessary expertise to create and implement safeguards which anticipate dangerous consequences of failures, monitor failures and their consequences, lessen the likelihood of failures that might cause harm and take appropriate remedial actions. Buyer will fully indemnify TI and its representatives against any damages arising out of the use of any TI components in safety-critical applications.

In some cases, TI components may be promoted specifically to facilitate safety-related applications. With such components, TI's goal is to help enable customers to design and create their own end-product solutions that meet applicable functional safety standards and requirements. Nonetheless, such components are subject to these terms.

No TI components are authorized for use in FDA Class III (or similar life-critical medical equipment) unless authorized officers of the parties have executed a special agreement specifically governing such use.

Only those TI components which TI has specifically designated as military grade or "enhanced plastic" are designed and intended for use in military/aerospace applications or environments. Buyer acknowledges and agrees that any military or aerospace use of TI components which have **not** been so designated is solely at the Buyer's risk, and that Buyer is solely responsible for compliance with all legal and regulatory requirements in connection with such use.

TI has specifically designated certain components as meeting ISO/TS16949 requirements, mainly for automotive use. In any case of use of non-designated products, TI will not be responsible for any failure to meet ISO/TS16949.

Products

Audio	www.ti.com/audio
Amplifiers	amplifier.ti.com
Data Converters	dataconverter.ti.com
DLP® Products	www.dlp.com
DSP	dsp.ti.com
Clocks and Timers	www.ti.com/clocks
Interface	interface.ti.com
Logic	logic.ti.com
Power Mgmt	power.ti.com
Microcontrollers	microcontroller.ti.com
RFID	www.ti-rfid.com
OMAP Applications Processors	www.ti.com/omap
Wireless Connectivity	www.ti.com/wirelessconnectivity

Applications

Automotive and Transportation	www.ti.com/automotive
Communications and Telecom	www.ti.com/communications
Computers and Peripherals	www.ti.com/computers
Consumer Electronics	www.ti.com/consumer-apps
Energy and Lighting	www.ti.com/energy
Industrial	www.ti.com/industrial
Medical	www.ti.com/medical
Security	www.ti.com/security
Space, Avionics and Defense	www.ti.com/space-avionics-defense
Video and Imaging	www.ti.com/video

TI E2E Community

e2e.ti.com