

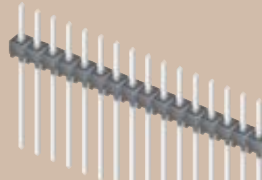

TSW-108-05-L-Q

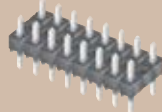

TSW-116-11-G-S

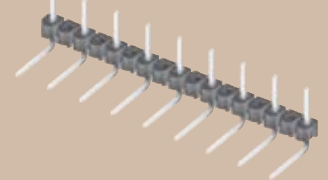

(2,54 mm) .100"

TSW, HTSW SERIES

THROUGH-HOLE .025" SQ POST HEADER

Mates with:

SSW, SSQ, SSM, ESW, ESQ, BCS, BSW, CES, SLW, IDSD, IDSS, SMSD, SMSS

SPECIFICATIONS

For complete specifications see www.samtec.com?TSW

TSW

Insulator Material:
Black Glass Filled Polyester
Terminal Material:
Phosphor Bronze
Plating:
Au or Sn over 50µ" (1,27 µm) Ni



Operating Temp Range:
-55°C to +125°C with Gold
-55°C to +105°C with Tin

Voltage Rating:
550 VAC mated with SSW;
500 VAC mated with BCS or ESQ;
450 VAC -RA/-RE mated with BCS or SSM

RoHS Compliant:
Yes
Lead-Free Solderable:
Wave Only

TYPE STRIP

TSW = Standard Strip

HTSW = Hi-Temp Strip

PIN CENTERS

-1 = .100" (2,54 mm) Centers, All Positions Filled

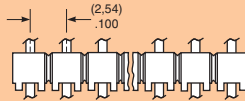

-2 = .200" (5,08 mm) Centers, Every Other Position Filled

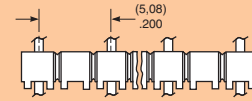

NO. PINS PER ROW

CURRENT RATING (PER CONTACT)						
AMBIENT TEMP	TSW mated with					
	ESW	SSW	SLW	SSQ	SSM	BCS
20°C	6.9A	6.9A	7.1A	7.6A	6.9A	5.9A
40°C	6A	6.1A	6.2A	6.9A	6A	5.2A
60°C	5.3A	5.3A	5.8A	5.9A	5.3A	4.7A
95°C	3.5A	3.5A	3.7A	3.9A	3.5A	3A

6 POSITIONS (2x3) POWERED

Straight Pin Versions

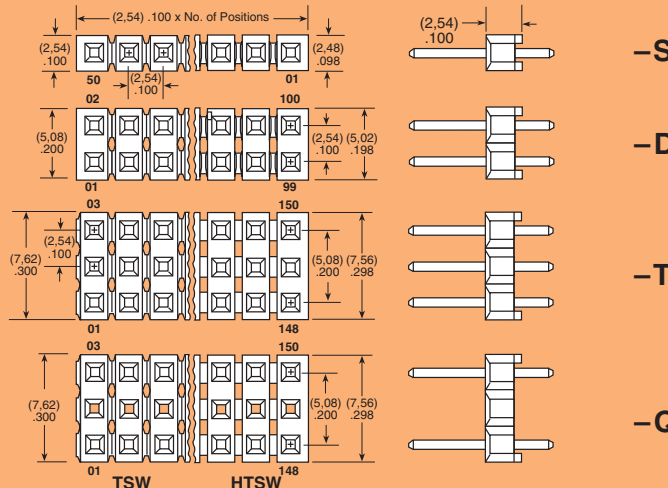

01 thru 50
= .100" (2,54 mm) Center Version

Right Angle Versions

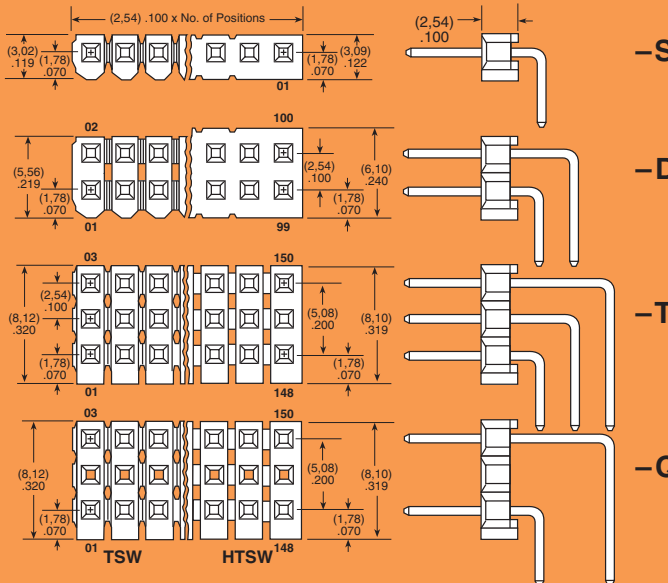

02 thru 25
= .200" (5,08 mm) Center Version

SPECIFICATIONS

For complete specifications see www.samtec.com?HTSW

HTSW

Same as TSW except:
Insulator Material:
Natural Liquid Crystal Polymer



ALSO AVAILABLE

Shunts. See SNT Series

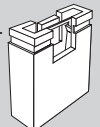

APPLICATIONS

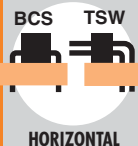

Note: Some lengths, styles and options are non-standard, non-returnable.

Due to technical progress, all designs, specifications and components are subject to change without notice.

WWW.SAMTEC.COM

TSW-109-10-F-D-RA

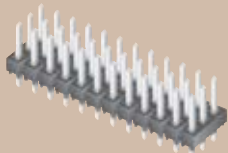

TSW-112-07-G-T

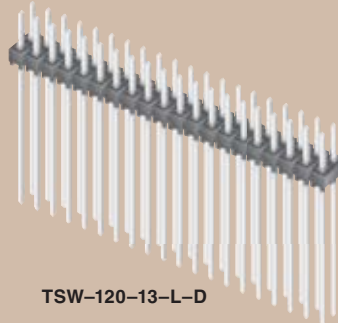

TSW-120-13-L-D

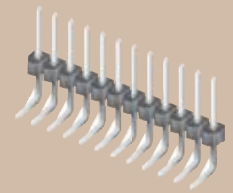

TSW-112-16-T-S-RE

LEAD STYLE

PLATING OPTION

ROW OPTION

OTHER OPTIONS

- F**
= Gold flash on post, Matte Tin on tail
- L**
= 10µ" (0,25 µm) Gold on post, Matte Tin on tail
- G**
= 10µ" (0,25 µm) Gold on post, Gold flash on balance
- T**
= Matte Tin

- S**
= Single Row
- D**
= Double Row
- T**
= Triple Row
- Q**
= Double Row (5,08 mm) .200" row space

- RA or -RE**
= Right Angle
- NA**
= Right Angle (using straight body for coplanar mating with SSW-RA series)
- LL**
= Locking Lead

- LC**
= Locking Clip (Styles -08 thru -13 & -22 only)
- LA**
= -RA Option with -LL Option
- “XXX”**
= Polarized Position

Note: Other Gold plating options available. Contact Samtec.

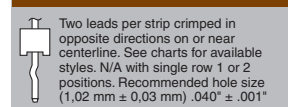
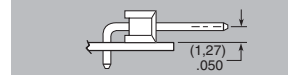
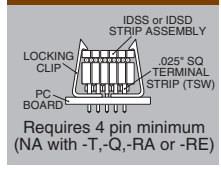

Straight Pin Versions

(Specify "LEAD STYLE" from chart)

STYLE	A	B	C
* -05	(3,30) .130	(8,51) .335	(2,67) .105
* -06	(2,41) .095	(7,62) .300	(2,67) .105
* -07	(2,54) .100	(10,92) .430	
* -08	(5,08) .200	(13,46) .530	
-09	(10,16) .400	(18,54) .730	
-10	(12,70) .500	(21,08) .830	(5,84) .230
-11	(15,24) .600	(23,62) .930	
-12	(17,78) .700	(26,16) 1,030	
-13	(22,86) .900	(31,24) 1,230	
-14	(2,79) .110	(13,46) .530	(8,13) .320
* -15		(18,54) .730	(13,21) .520
* -16	(7,87) .310		(8,13) .320
* -17	(2,79) .110	(21,08) .830	(15,74) .620

STYLE	A	B	C
* -18		(23,62) .930	(18,29) .720
* -19	(2,79) .110	(26,16) 1,030	(20,83) .820
* -20		(31,24) 1,230	(25,91) 1,020
* -21		(36,32) 1,430	(30,99) 1,220
* -22	(7,62) .300	(16,00) .630	(5,84) .230
* -23	(2,92) .115	(11,30) .445	(6,73) .265
* -24	(5,33) .210	(16,00) .630	(8,13) .320
* -25	(3,20) .126	(11,58) .456	
▲ -26	(25,40) 1,000	(33,78) 1,330	(5,84) .230
* -28	(20,32) .800	(28,70) 1,130	
* -29	(23,11) .910	(33,78) 1,330	(8,13) .320
* -30	(18,03) .035	(28,70) 1,130	
+ -41	(0,89) .035	(9,27) .365	(5,84) .230
+ -42	(1,27) .050	(11,94) .470	(8,13) .320

* Available with -LL (Locking Lead) Option

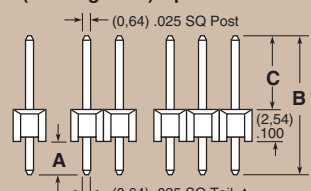

Specify -07 for best mate with IDXX Series IDC Cable

+ Style -41 & -42 available with HTSW only.
▲ Except: Style -26 (0,46) .018 DIA Tail

Right Angle Versions

(Specify "LEAD STYLE" from chart and select -RA or -RE from other options)

-RA LEAD STYLE	SINGLE (-S)		DOUBLE (-D)	TRIPLE (-T & -Q)	-RE LEAD STYLE	SINGLE (A)	C
	A	C	A	A			
-08	(2,29) .090		(2,29) .090	(2,29) .090	-09	(4,83) .190	
-09	(7,37) .290		(7,37) .290	(7,37) .290	-10	(7,37) .290	
-10	(9,91) .390	(5,84) .230	(9,91) .390	(9,91) .390	-11	(9,91) .390	(5,84) .230
-11	(12,45) .490		(12,45) .490	(12,45) .490	-12	(12,45) .490	
-12	(14,99) .590		(14,99) .590	(14,99) .590	-13	(17,53) .690	
-13	(20,07) .790		(20,07) .790	N/A	-16	(2,54) .100	(8,13) .320
* -16	(5,08) .200	(8,13) .320	(5,08) .200	(5,08) .200	-21	(22,61) .890	
-21	(25,15) .990	(5,84) .230	N/A	N/A	-22	(2,29) .090	(5,84) .230
* -22	(4,83) .190		(4,83) .190	(4,83) .190	-27	(20,07) .790	
* -25	(2,54) .100	(8,13) .320	(2,54) .100	(2,54) .100	-28	(17,53) .690	
-27	(22,61) .890	(5,84) .230	N/A	N/A	-29	(20,32) .800	
-28	(17,53) .690		(17,53) .690	N/A	-30	(15,24) .600	
-29	(20,32) .800	(8,13) .320	N/A	N/A			
-30	(15,24) .600		(15,24) .600				

* Available with -LA (Locking Lead) Option

ALSO AVAILABLE

Elevated Right Angle option. Call Samtec.

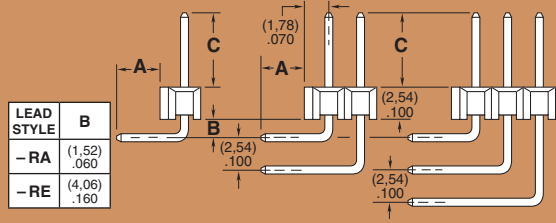

Due to technical progress, all designs, specifications and components are subject to change without notice.

WWW.SAMTEC.COM