

Low-Noise, Wide-Bandwidth, High PSRR, Low-Dropout 1-A Linear Regulator

FEATURES

- Low-Dropout 1-A Regulator with Enable
- Adjustable Output Voltage: 0.8 V to 6.0 V
- Wide-Bandwidth High PSRR:
 - 80 dB at 1 kHz
 - 60 dB at 100 kHz
 - 54 dB at 1 MHz
- Low Noise: 23.5 μV_{RMS} typical (100 Hz to 100 kHz)
- Stable with a 4.7- μF Capacitance
- Excellent Load/Line Transient Response
- 3% Overall Accuracy (over Load/Line/Temperature)
- Over-Current and Over-Temperature Protection
- Very Low Dropout: 170 mV Typical at 1 A
- Package: 3-mm \times 3-mm SON-8

APPLICATIONS

- Telecom Infrastructure
- Audio
- High-Speed I/F (PLL/VCO)

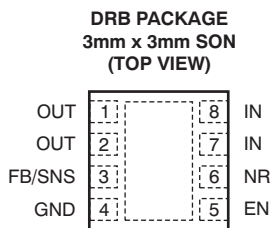

DESCRIPTION

The TPS7A8101 low-dropout linear regulator (LDO) offers very good performance in noise and power-supply rejection ratio (PSRR) at the output. This LDO uses an advanced BiCMOS process and a PMOSFET pass device to achieve very low noise, excellent transient response, and excellent PSRR performance.

The TPS7A8101 is stable with a 4.7- μF ceramic output capacitor, and uses a precision voltage reference and feedback loop to achieve a worst-case accuracy of 3% over all load, line, process, and temperature variations.

This device is fully specified over the temperature range of $T_J = -40^\circ\text{C}$ to $+125^\circ\text{C}$ and is offered in a 3-mm \times 3-mm, SON-8 package with a thermal pad.

Typical Application Circuit

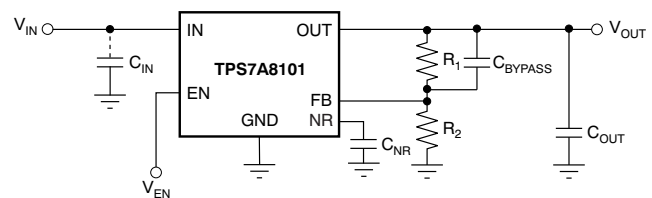

TYPICAL POWER-SUPPLY RIPPLE REJECTION

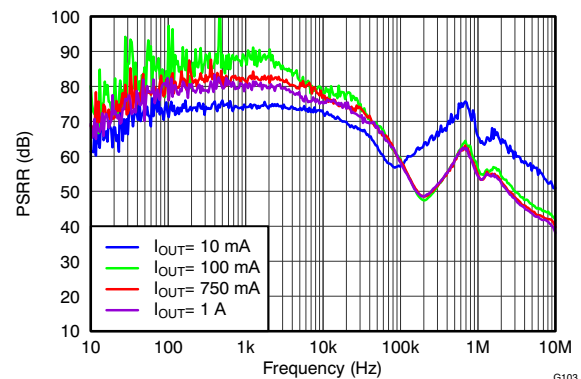

G103



Please be aware that an important notice concerning availability, standard warranty, and use in critical applications of Texas Instruments semiconductor products and disclaimers thereto appears at the end of this data sheet.

All trademarks are the property of their respective owners.



This integrated circuit can be damaged by ESD. Texas Instruments recommends that all integrated circuits be handled with appropriate precautions. Failure to observe proper handling and installation procedures can cause damage.

ESD damage can range from subtle performance degradation to complete device failure. Precision integrated circuits may be more susceptible to damage because very small parametric changes could cause the device not to meet its published specifications.

ORDERING INFORMATION⁽¹⁾

PRODUCT	V _{OUT}
TPS7A8101yyyz	YYY is package designator. Z is package quantity.

(1) For the most current package and ordering information see the Package Option Addendum at the end of this document, or visit the device product folder on www.ti.com.

ABSOLUTE MAXIMUM RATINGS

Over operating free-air temperature range (unless otherwise noted).⁽¹⁾

		VALUE		UNIT
		MIN	MAX	
Voltage	IN	-0.3	+7.0	V
	FB, NR	-0.3	+3.6	V
	EN	-0.3	V _{IN} + 0.3 ⁽²⁾	V
	OUT	-0.3	+7.0	V
Current	OUT	Internally Limited		A
Temperature	Operating virtual junction, T _J	-55	+150	°C
	Storage, T _{stg}	-55	+150	°C
Electrostatic Discharge Rating ⁽³⁾	Human body model (HBM) QSS 009-105 (JESD22-A114A)	2		kV
	Charged device model (CDM) QSS 009-147 (JESD22-C101B.01)	500		V

(1) Stresses beyond those listed under *Absolute Maximum Ratings* may cause permanent damage to the device. These are stress ratings only, and functional operation of the device at these or any other conditions beyond those indicated is not implied. Exposure to absolute-maximum-rated conditions for extended periods may affect device reliability.

(2) V_{EN} absolute maximum rating is V_{IN} + 0.3 V or +7.0 V, whichever is smaller.

(3) ESD testing is performed according to the respective JESD22 JEDEC standard.

THERMAL INFORMATION

THERMAL METRIC ⁽¹⁾		TPS7A8101	UNITS
		DRB ⁽²⁾	
		8 PINS	
θ_{JA}	Junction-to-ambient thermal resistance ⁽³⁾	45.7	°C/W
θ_{JcTop}	Junction-to-case (top) thermal resistance ⁽⁴⁾	53.2	
θ_{JB}	Junction-to-board thermal resistance ⁽⁵⁾	21.3	
ψ_{JT}	Junction-to-top characterization parameter ⁽⁶⁾	0.9	
ψ_{JB}	Junction-to-board characterization parameter ⁽⁷⁾	21.4	
θ_{JcBot}	Junction-to-case (bottom) thermal resistance ⁽⁸⁾	5.2	

- (1) For more information about traditional and new thermal metrics, see the [IC Package Thermal Metrics application report, SPRA953A](#).
- (2) Thermal data for the DRB package are derived by thermal simulations based on JEDEC-standard methodology as specified in the JESD51 series. The following assumptions are used in the simulations:
 - (a) The exposed pad is connected to the PCB ground layer through a 2x2 thermal via array.
 - (b) The top and bottom copper layers are assumed to have a 20% thermal conductivity of copper representing a 20% copper coverage.
 - (c) This data were generated with only a single device at the center of a JEDEC high-K (2s2p) board with 3in × 3in copper area. To understand the effects of the copper area on thermal performance, refer to the [Power Dissipation](#) and [Estimating Junction Temperature](#) sections.
- (3) The junction-to-ambient thermal resistance under natural convection is obtained in a simulation on a JEDEC-standard, high-K board, as specified in JESD51-7, in an environment described in JESD51-2a.
- (4) The junction-to-case (top) thermal resistance is obtained by simulating a cold plate test on the top of the package. No specific JEDEC-standard test exists, but a close description can be found in the ANSI SEMI standard G30-88.
- (5) The junction-to-board thermal resistance is obtained by simulating in an environment with a ring cold plate fixture to control the PCB temperature, as described in JESD51-8.
- (6) The junction-to-top characterization parameter, ψ_{JT} , estimates the junction temperature of a device in a real system and is extracted from the simulation data to obtain θ_{JA} using a procedure described in JESD51-2a (sections 6 and 7).
- (7) The junction-to-board characterization parameter, ψ_{JB} , estimates the junction temperature of a device in a real system and is extracted from the simulation data to obtain θ_{JA} using a procedure described in JESD51-2a (sections 6 and 7).
- (8) The junction-to-case (bottom) thermal resistance is obtained by simulating a cold plate test on the exposed (power) pad. No specific JEDEC standard test exists, but a close description can be found in the ANSI SEMI standard G30-88.

ELECTRICAL CHARACTERISTICS

Over the operating temperature range of $T_J = -40^\circ\text{C}$ to $+125^\circ\text{C}$, $V_{IN} = V_{OUT(TYP)} + 0.5\text{ V}$ or 2.2 V (whichever is greater), $I_{OUT} = 1\text{ mA}$, $V_{EN} = 2.2\text{ V}$, $C_{OUT} = 4.7\text{ }\mu\text{F}$, $C_{NR} = 0.01\text{ }\mu\text{F}$, and $C_{BYPASS} = 0\text{ }\mu\text{F}$, unless otherwise noted. TPS7A8101 is tested at $V_{OUT} = 0.8\text{ V}$ and $V_{OUT} = 6.0\text{ V}$. Typical values are at $T_J = +25^\circ\text{C}$.

PARAMETER	TEST CONDITIONS	TPS7A8101			UNIT	
		MIN	TYP	MAX		
V_{IN}	Input voltage range ⁽¹⁾	2.2		6.5	V	
V_{NR}	Internal reference	0.790	0.800	0.810	V	
V_{OUT}	Output voltage range	0.8		6.0	V	
	Output accuracy ⁽²⁾	$V_{OUT} + 0.5\text{ V} \leq V_{IN} \leq 6.0\text{ V}$, $V_{IN} \geq 2.5\text{ V}$, $100\text{ mA} \leq I_{OUT} \leq 500\text{ mA}$, $0^\circ\text{C} \leq T_J \leq 85^\circ\text{C}$	-2.0		+2.0	%
		$V_{OUT} + 0.5\text{ V} \leq V_{IN} \leq 6.5\text{ V}$, $V_{IN} \geq 2.2\text{ V}$, $100\text{ mA} \leq I_{OUT} \leq 1\text{ A}$	-3.0	± 0.3	+3.0	%
$\Delta V_{O(\Delta VI)}$	Line regulation	$V_{OUT(NOM)} + 0.5\text{ V} \leq V_{IN} \leq 6.5\text{ V}$, $V_{IN} \geq 2.2\text{ V}$, $I_{OUT} = 100\text{ mA}$		150		$\mu\text{V/V}$
$\Delta V_{O(\Delta IL)}$	Load regulation	$100\text{ mA} \leq I_{OUT} \leq 1\text{ A}$		2		$\mu\text{V/mA}$
V_{DO}	Dropout voltage ⁽³⁾	$V_{OUT} + 0.5\text{ V} \leq V_{IN} \leq 6.5\text{ V}$, $V_{IN} \geq 2.2\text{ V}$, $I_{OUT} = 500\text{ mA}$, $V_{FB} = \text{GND}$ or $V_{SNS} = \text{GND}$			250	mV
		$V_{OUT} + 0.5\text{ V} \leq V_{IN} \leq 6.5\text{ V}$, $V_{IN} \geq 2.5\text{ V}$, $I_{OUT} = 750\text{ mA}$, $V_{FB} = \text{GND}$ or $V_{SNS} = \text{GND}$			350	mV
		$V_{OUT} + 0.5\text{ V} \leq V_{IN} \leq 6.5\text{ V}$, $V_{IN} \geq 2.5\text{ V}$, $I_{OUT} = 1\text{ A}$, $V_{FB} = \text{GND}$ or $V_{SNS} = \text{GND}$			500	mV
I_{LIM}	Output current limit	$V_{OUT} = 0.85 \times V_{OUT(NOM)}$, $V_{IN} \geq 3.3\text{ V}$	1100	1400	2000	mA
I_{GND}	Ground pin current	$I_{OUT} = 1\text{ mA}$		60	100	μA
		$I_{OUT} = 1\text{ A}$			350	μA
I_{SHDN}	Shutdown current (I_{GND})	$V_{EN} \leq 0.4\text{ V}$, $V_{IN} \geq 2.2\text{ V}$, $R_L = 1\text{ k}\Omega$, $0^\circ\text{C} \leq T_J \leq 85^\circ\text{C}$		0.20	2	μA
I_{FB}	Feedback pin current	$V_{IN} = 6.5\text{ V}$, $V_{FB} = 0.8\text{ V}$		0.02	1.0	μA
PSRR	Power-supply rejection ratio	$V_{IN} = 4.3\text{ V}$, $V_{OUT} = 3.3\text{ V}$, $I_{OUT} = 750\text{ mA}$	$f = 100\text{ Hz}$		80	dB
			$f = 1\text{ kHz}$		82	dB
			$f = 10\text{ kHz}$		78	dB
			$f = 100\text{ kHz}$		60	dB
			$f = 1\text{ MHz}$		54	dB
V_n	Output noise voltage	$BW = 100\text{ Hz}$ to 100 kHz , $V_{IN} = 3.8\text{ V}$, $V_{OUT} = 3.3\text{ V}$, $I_{OUT} = 100\text{ mA}$, $C_{NR} = C_{BYPASS} = 470\text{ nF}$		23.5		μV_{RMS}
$V_{EN(HI)}$	Enable high (enabled)	$2.2\text{ V} \leq V_{IN} \leq 3.6\text{ V}$, $R_L = 1\text{ k}\Omega$	1.2			V
		$3.6\text{ V} < V_{IN} \leq 6.5\text{ V}$, $R_L = 1\text{ k}\Omega$	1.35			V
$V_{EN(LO)}$	Enable low (shutdown)	$R_L = 1\text{ k}\Omega$	0		0.4	V
$I_{EN(HI)}$	Enable pin current, enabled	$V_{IN} = V_{EN} = 6.5\text{ V}$		0.02	1.0	μA
t_{STR}	Startup time	$V_{OUT(NOM)} = 3.3\text{ V}$, $V_{OUT} = 0\%$ to $90\% V_{OUT(NOM)}$, $R_L = 3.3\text{ k}\Omega$, $C_{OUT} = 10\text{ }\mu\text{F}$, $C_{NR} = 470\text{ nF}$		80		ms
UVLO	Undervoltage lockout	V_{IN} rising, $R_L = 1\text{ k}\Omega$	1.86	2	2.10	V
	Hysteresis	V_{IN} falling, $R_L = 1\text{ k}\Omega$		75		mV
T_{SD}	Thermal shutdown temperature	Shutdown, temperature increasing		+160		$^\circ\text{C}$
		Reset, temperature decreasing		+140		$^\circ\text{C}$
T_J	Operating junction temperature		-40		+125	$^\circ\text{C}$

(1) Minimum $V_{IN} = V_{OUT} + V_{DO}$ or 2.2 V , whichever is greater.

(2) The TPS7A8101 does not include external resistor tolerances and it is not tested at this condition: $V_{OUT} = 0.8\text{ V}$, $4.5\text{ V} \leq V_{IN} \leq 6.5\text{ V}$, and $750\text{ mA} \leq I_{OUT} \leq 1\text{ A}$ because the power dissipation is greater than the maximum rating of the package.

(3) V_{DO} is not measured for fixed output voltage devices with $V_{OUT} < 1.7\text{ V}$ because minimum $V_{IN} = 2.2\text{ V}$.

FUNCTIONAL BLOCK DIAGRAM

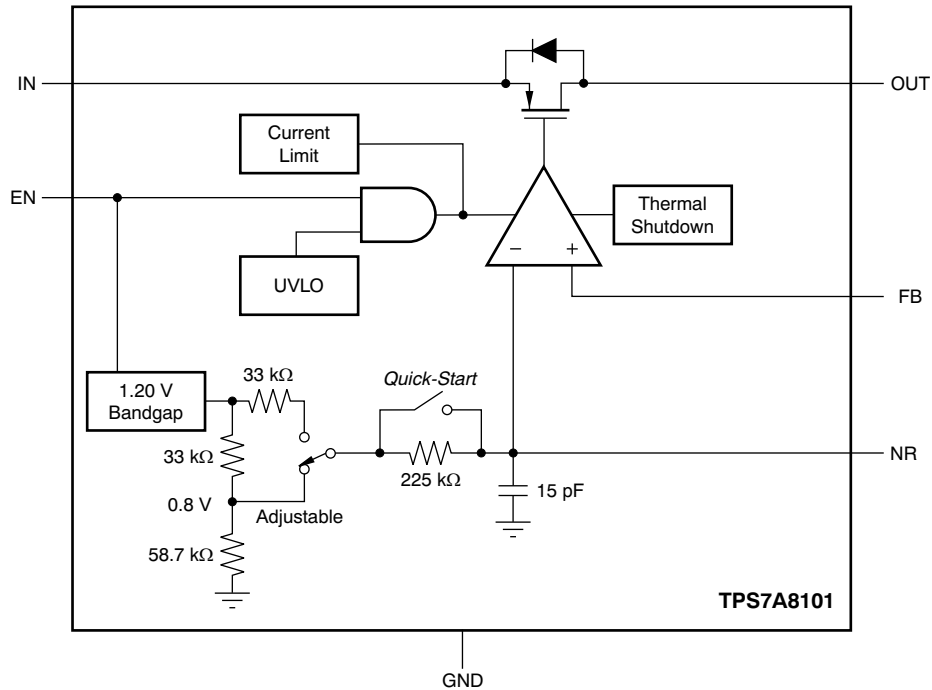
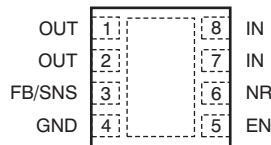

Figure 1. Functional Block Diagram

PIN CONFIGURATION

DRB PACKAGE
3mm x 3mm SON-8
(TOP VIEW)



PIN DESCRIPTIONS

PIN		
NAME	NO.	DESCRIPTION
EN	5	Driving this pin high turns on the regulator. Driving this pin low puts the regulator into shutdown mode. Refer to the <i>Shutdown</i> section for more details. EN must not be left floating and can be connected to IN if not used.
FB	3	This pin is the input to the control-loop error amplifier and is used to set the output voltage of the device.
GND	4, pad	Ground
IN	7, 8	Unregulated input supply
NR	6	Connect an external capacitor between this pin and ground to reduce output noise to very low levels. The capacitor also slows down the V _{OUT} ramp (RC softstart).
OUT	1, 2	Regulator output. A 4.7-μF or larger capacitor of any type is required for stability.

TYPICAL CHARACTERISTICS: TPS7A8101

At $V_{OUT(TYP)} = 3.3\text{ V}$, $V_{IN} = V_{OUT(TYP)} + 0.5\text{ V}$ or 2.2 V (whichever is greater), $I_{OUT} = 100\text{ mA}$, $V_{EN} = V_{IN}$, $C_{IN} = 1\text{ }\mu\text{F}$, $C_{OUT} = 4.7\text{ }\mu\text{F}$, and $C_{NR} = 0.01\text{ }\mu\text{F}$; all temperature values refer to T_J , unless otherwise noted.

LOAD REGULATION

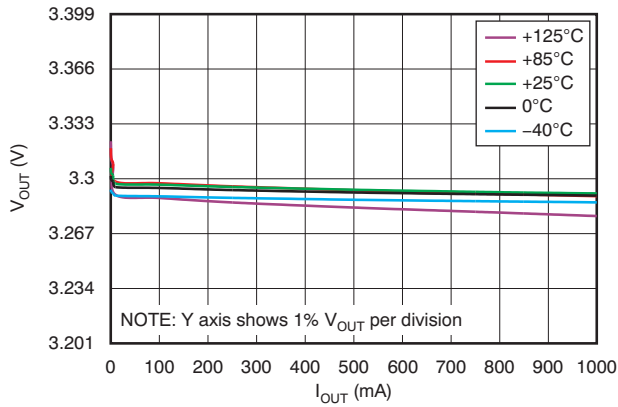

Figure 2.

LOAD REGULATION UNDER LIGHT LOADS

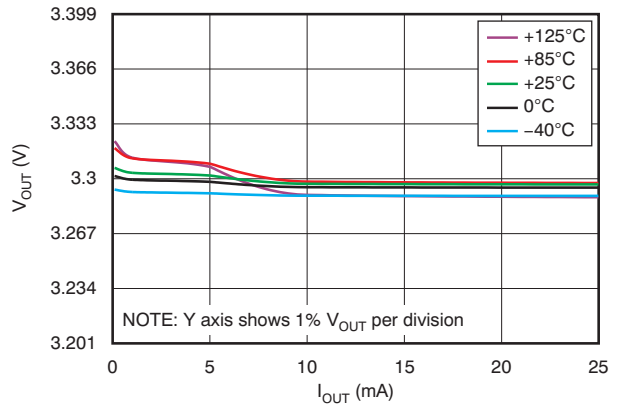

Figure 3.

LINE REGULATION

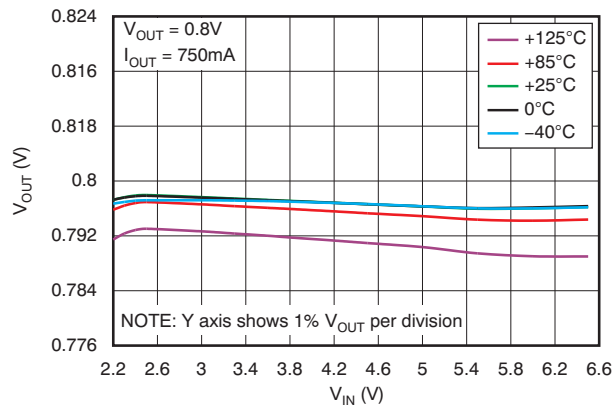

Figure 4.

LINE REGULATION UNDER LIGHT LOADS

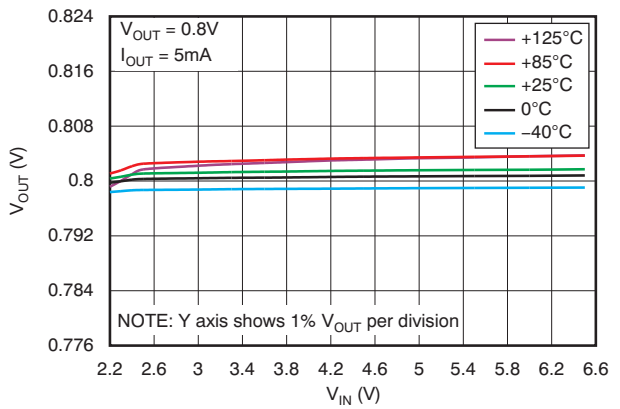

Figure 5.

TYPICAL CHARACTERISTICS: TPS7A8101 (continued)

At $V_{OUT(TYP)} = 3.3\text{ V}$, $V_{IN} = V_{OUT(TYP)} + 0.5\text{ V}$ or 2.2 V (whichever is greater), $I_{OUT} = 100\text{ mA}$, $V_{EN} = V_{IN}$, $C_{IN} = 1\text{ }\mu\text{F}$, $C_{OUT} = 4.7\text{ }\mu\text{F}$, and $C_{NR} = 0.01\text{ }\mu\text{F}$; all temperature values refer to T_J , unless otherwise noted.

DROPOUT VOLTAGE vs INPUT VOLTAGE

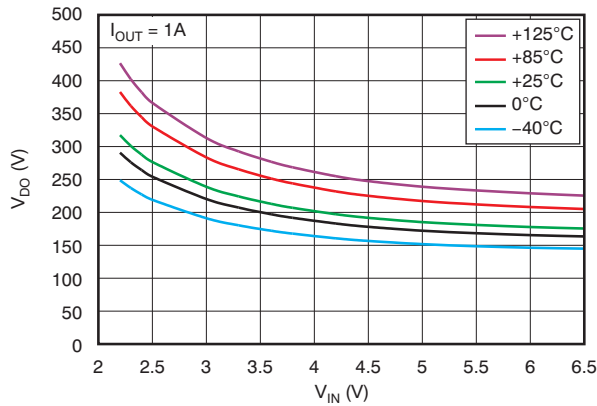

Figure 6.

DROPOUT VOLTAGE vs INPUT VOLTAGE

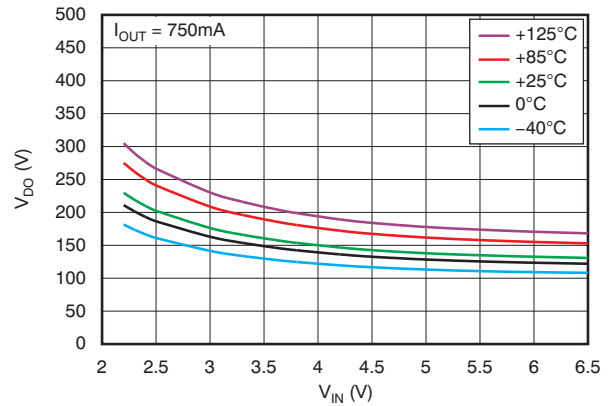

Figure 7.

DROPOUT VOLTAGE vs INPUT VOLTAGE

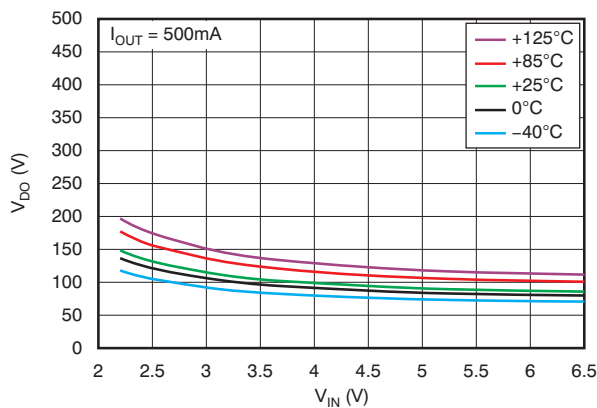

Figure 8.

DROPOUT VOLTAGE vs LOAD CURRENT

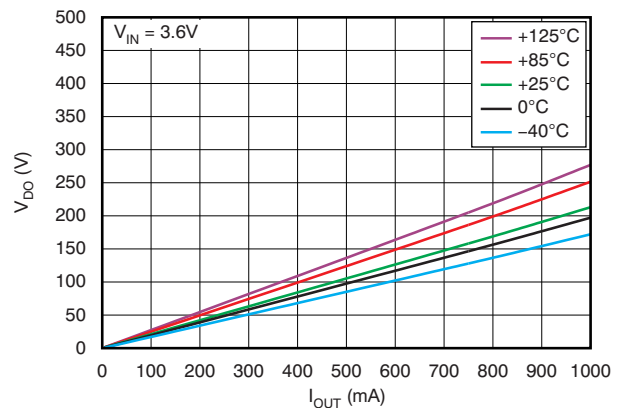

Figure 9.

DROPOUT VOLTAGE vs TEMPERATURE

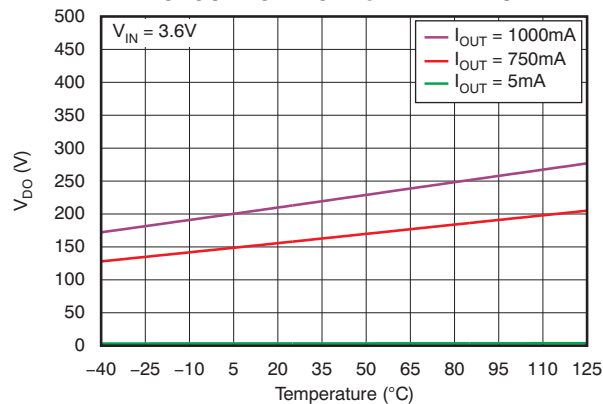

Figure 10.

TYPICAL CHARACTERISTICS: TPS7A8101 (continued)

At $V_{OUT(TYP)} = 3.3\text{ V}$, $V_{IN} = V_{OUT(TYP)} + 0.5\text{ V}$ or 2.2 V (whichever is greater), $I_{OUT} = 100\text{ mA}$, $V_{EN} = V_{IN}$, $C_{IN} = 1\text{ }\mu\text{F}$, $C_{OUT} = 4.7\text{ }\mu\text{F}$, and $C_{NR} = 0.01\text{ }\mu\text{F}$; all temperature values refer to T_J , unless otherwise noted.

GROUND PIN CURRENT vs INPUT VOLTAGE

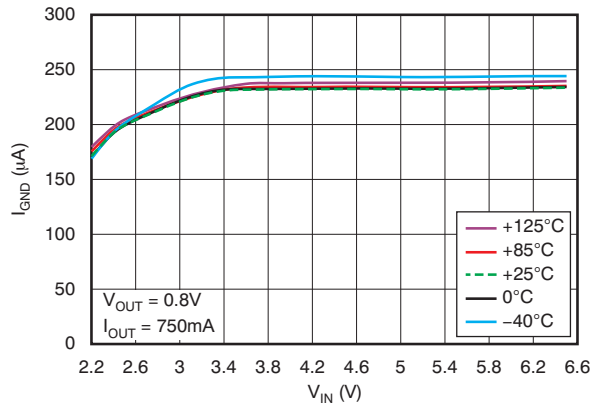

Figure 11.

GROUND PIN CURRENT vs LOAD CURRENT

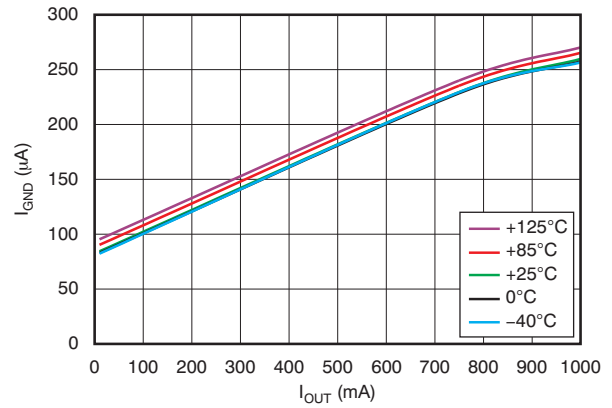

Figure 12.

SHUTDOWN CURRENT vs TEMPERATURE

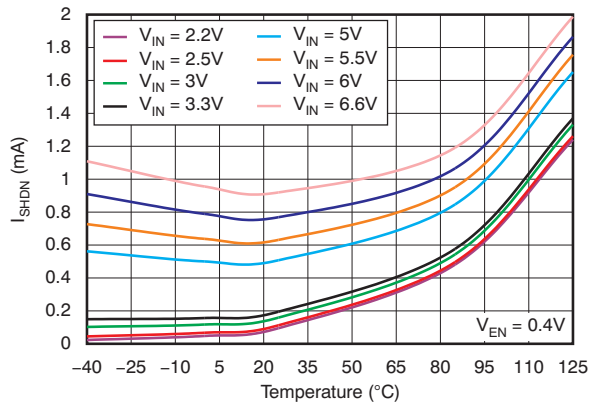

Figure 13.

CURRENT LIMIT vs TEMPERATURE

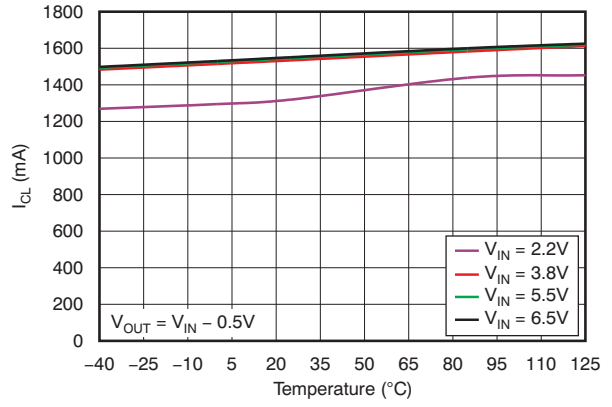

Figure 14.

TYPICAL CHARACTERISTICS: TPS7A8101 (continued)

At $V_{OUT(TYP)} = 3.3\text{ V}$, $V_{IN} = V_{OUT(TYP)} + 0.5\text{ V}$ or 2.2 V (whichever is greater), $I_{OUT} = 100\text{ mA}$, $V_{EN} = V_{IN}$, $C_{IN} = 1\text{ }\mu\text{F}$, $C_{OUT} = 4.7\text{ }\mu\text{F}$, and $C_{NR} = 0.01\text{ }\mu\text{F}$; all temperature values refer to T_J , unless otherwise noted.

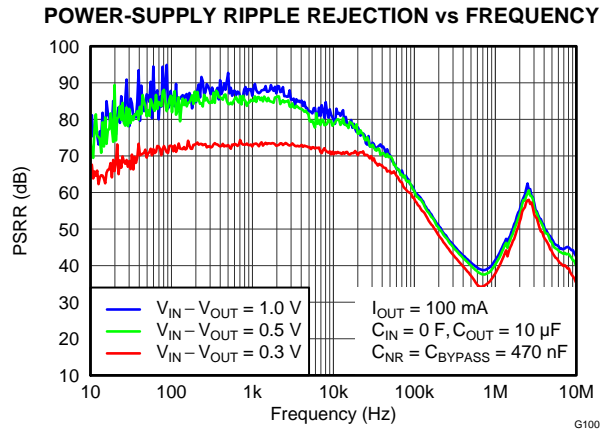

Figure 15.

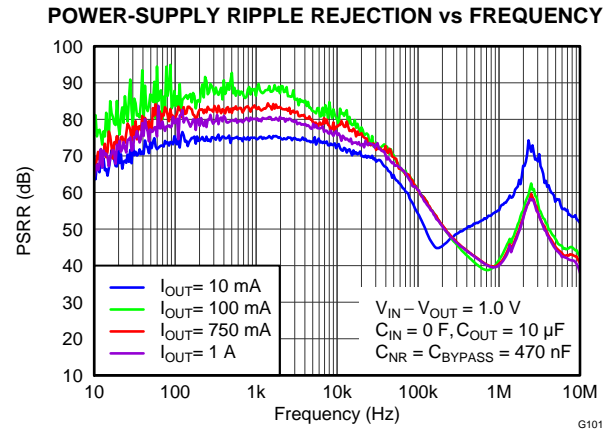

Figure 16.

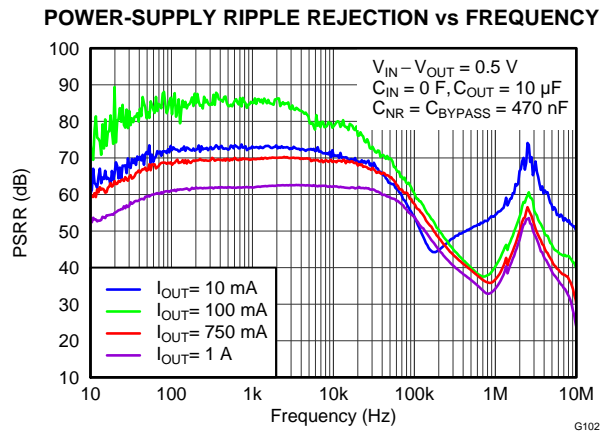

Figure 17.

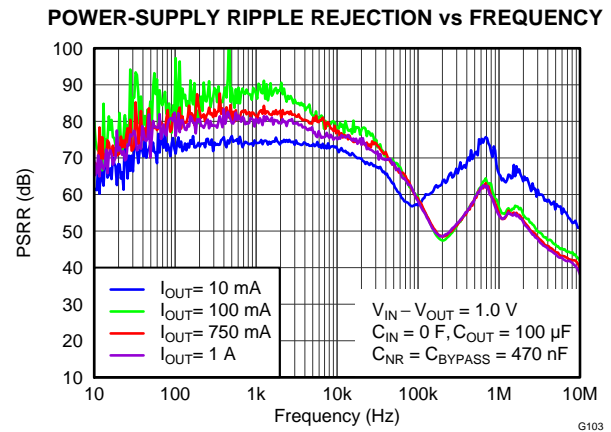

Figure 18.

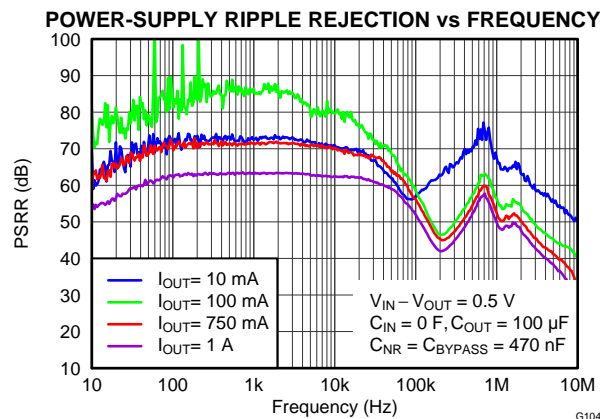

Figure 19.

TYPICAL CHARACTERISTICS: TPS7A8101 (continued)

At $V_{OUT(TYP)} = 3.3\text{ V}$, $V_{IN} = V_{OUT(TYP)} + 0.5\text{ V}$ or 2.2 V (whichever is greater), $I_{OUT} = 100\text{ mA}$, $V_{EN} = V_{IN}$, $C_{IN} = 1\text{ }\mu\text{F}$, $C_{OUT} = 4.7\text{ }\mu\text{F}$, and $C_{NR} = 0.01\text{ }\mu\text{F}$; all temperature values refer to T_J , unless otherwise noted.

POWER-SUPPLY RIPPLE REJECTION vs DROPOUT VOLTAGE

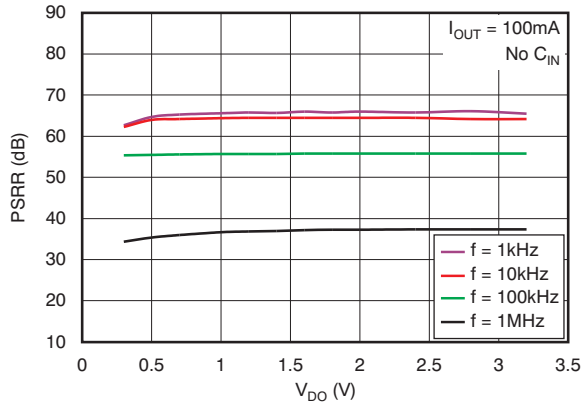

Figure 20.

POWER-SUPPLY RIPPLE REJECTION vs DROPOUT VOLTAGE

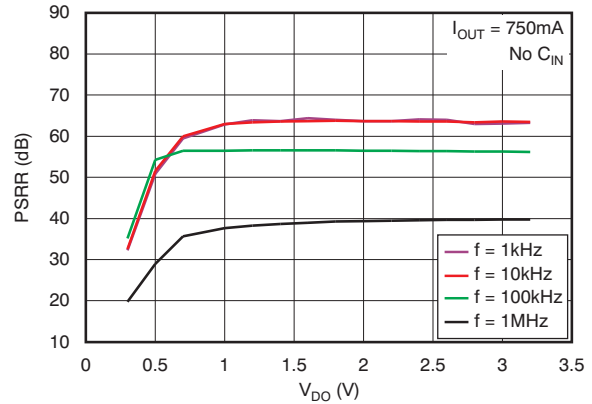

Figure 21.

OUTPUT SPECTRAL NOISE DENSITY vs FREQUENCY

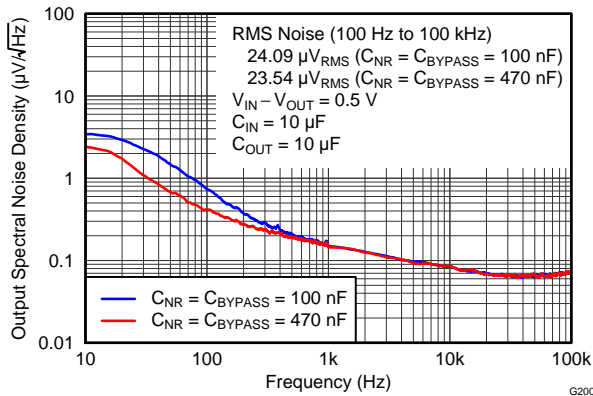

Figure 22.

OUTPUT SPECTRAL NOISE DENSITY vs FREQUENCY

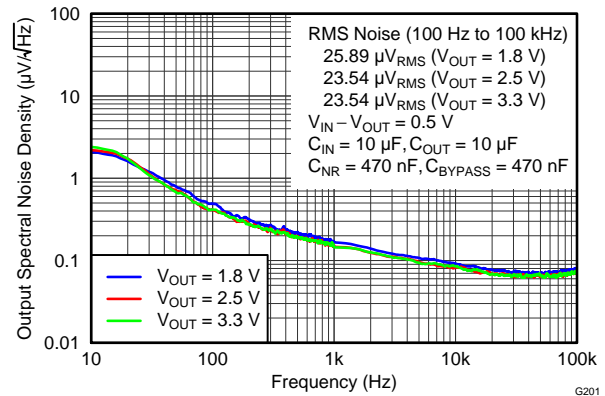

Figure 23.

OUTPUT SPECTRAL NOISE DENSITY vs FREQUENCY

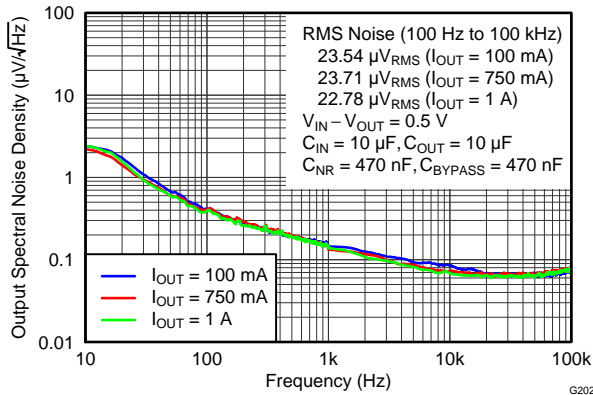

Figure 24.

OUTPUT SPECTRAL NOISE DENSITY vs FREQUENCY

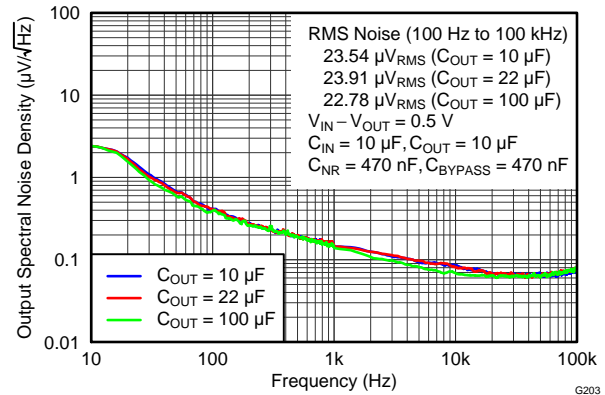

Figure 25.

TYPICAL CHARACTERISTICS: TPS7A8101 (continued)

At $V_{OUT(TYP)} = 3.3\text{ V}$, $V_{IN} = V_{OUT(TYP)} + 0.5\text{ V}$ or 2.2 V (whichever is greater), $I_{OUT} = 100\text{ mA}$, $V_{EN} = V_{IN}$, $C_{IN} = 1\text{ }\mu\text{F}$, $C_{OUT} = 4.7\text{ }\mu\text{F}$, and $C_{NR} = 0.01\text{ }\mu\text{F}$; all temperature values refer to T_J , unless otherwise noted.

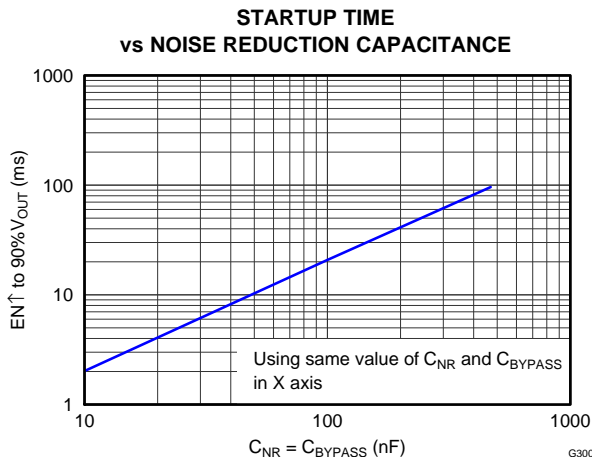

Figure 26.

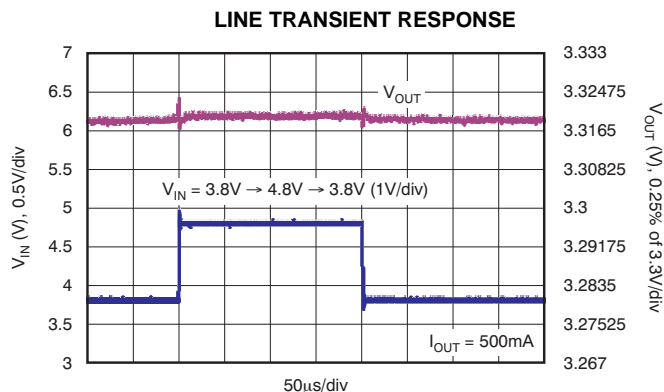

Figure 27.

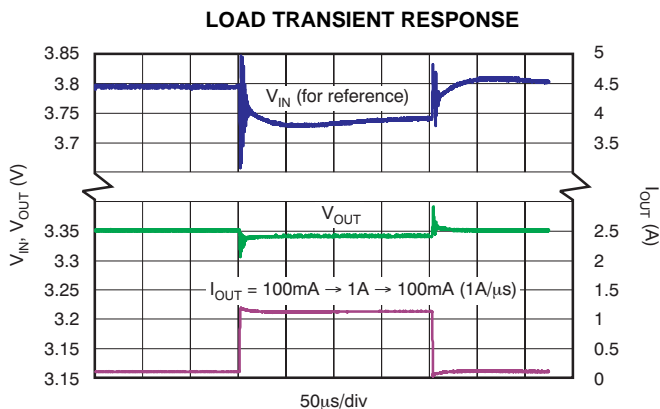

Figure 28.

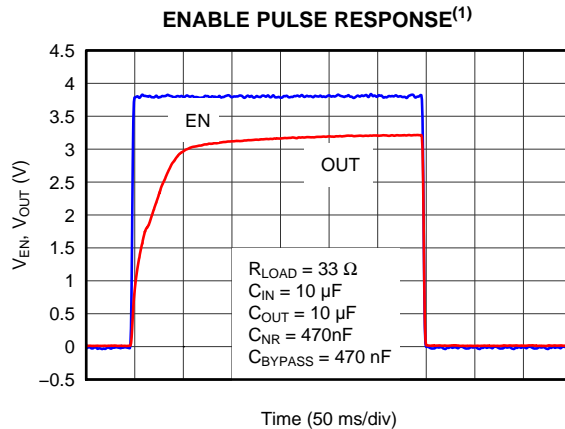

Figure 29.

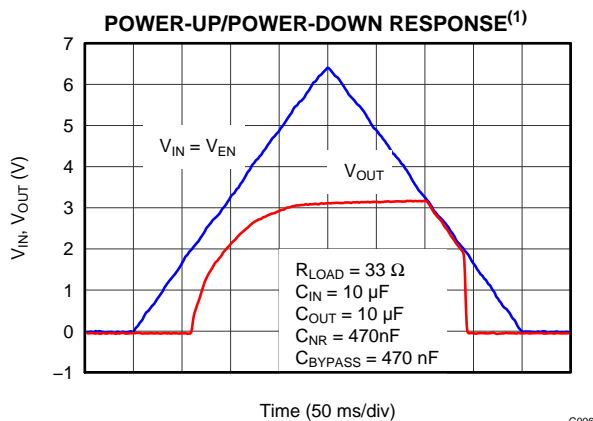

Figure 30.

(1) The internal reference requires approximately 80 ms of rampup time (see [STARTUP](#)) from the enable event; therefore, V_{OUT} fully reaches the target output voltage of 3.3 V in 80 ms from startup.

APPLICATION INFORMATION

OVERVIEW

The TPS7A8101 belongs to a family of new generation LDO regulators that use innovative circuitry to achieve wide bandwidth and high loop gain, resulting in extremely high PSRR (over a 1-MHz range) at very low headroom ($V_{IN} - V_{OUT}$). A noise reduction capacitor (C_{NR}) at the NR pin and a bypass capacitor (C_{BYPASS}) bypass noise generated by the bandgap reference in order to improve PSRR, while a quick-start circuit fast-charges the noise reduction capacitor. This family of regulators offers sub-bandgap output voltages, current limit, and thermal protection, and is fully specified from -40°C to $+125^{\circ}\text{C}$.

Recommended Component Values

Table 1. Recommended Capacitor Values

SYMBOL	NAME	VALUE
C_{IN}	Input capacitor	10 μF
C_{OUT}	Output capacitor	10 μF
C_{NR}	Noise reduction capacitor between NR and GND	470 nF
C_{BYPASS}	Noise reduction capacitor across R_1	470 nF

Table 2. Recommended Feedback Resistor Values for Common Output Voltages

V_{OUT}	R_1	R_2
0.8 V	0 Ω (Short)	10.0 k Ω
1.0 V	2.49 k Ω	10.0 k Ω
1.2 V	4.99 k Ω	10.0 k Ω
1.5 V	8.87 k Ω	10.0 k Ω
1.8 V	12.5 k Ω	10.0 k Ω
2.5 V	21.0 k Ω	10.0 k Ω
3.3 V	30.9 k Ω	10.0 k Ω
5.0 V	52.3 k Ω	10.0 k Ω

TYPICAL APPLICATION CONFIGURATION

Figure 31 illustrates the connections for the device.

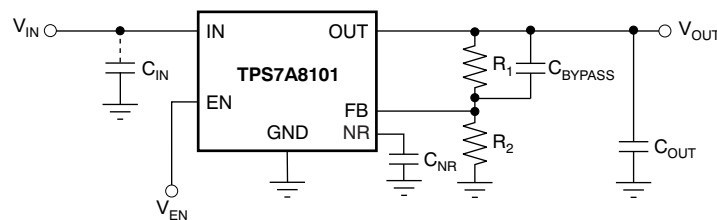

Figure 31. Typical Application Circuit (Adjustable Voltage Version)

The voltage on the FB pin sets the output voltage and is determined by the values of R_1 and R_2 . The values of R_1 and R_2 can be calculated for any voltage using the formula given in Equation 1:

$$V_{OUT} = \frac{(R_1 + R_2)}{R_2} \times 0.800 \quad (1)$$

Table 2 shows sample resistor values for common output voltages. In Table 2, E96 series resistors are used, and all values meet 1% of the target V_{OUT} , assuming resistors with zero error. For the actual design, pay attention to any resistor error factors. Using lower values for R_1 and R_2 reduces the noise injected from the FB pin.

INPUT AND OUTPUT CAPACITOR REQUIREMENTS

Although an input capacitor is not required for stability, it is good analog design practice to connect a 0.1- μF to 1.0- μF low equivalent series resistance (ESR) capacitor across the input supply near the regulator. This capacitor counteracts reactive input sources and improves transient response, noise rejection, and ripple rejection. A higher-value capacitor may be necessary if large, fast rise-time load transients are anticipated or if the device is located several inches from the power source. If source impedance is not sufficiently low, a 0.1- μF input capacitor may be necessary to ensure stability.

The TPS7A8101 is designed to be stable with standard ceramic capacitors of capacitance values 4.7 μF or larger. This device is evaluated using a 10- μF ceramic capacitor of 10-V rating, 10% tolerance, X5R type, and 0805 size (2.0 mm x 1.25 mm).

X5R- and X7R-type capacitors are highly recommended because they have minimal variation in value and ESR over temperature. Maximum ESR should be less than 1.0 Ω .

OUTPUT NOISE

In most LDOs, the bandgap is the dominant noise source. If a noise reduction capacitor (C_{NR}) is used with the TPS7A8101, the bandgap does not contribute significantly to noise. Instead, noise is dominated by the output resistor divider and the error amplifier input. If a bypass capacitor (C_{BYPASS}) across the high-side feedback resistor (R_1) is used with the TPS7A8101 in addition to C_{NR} , noise from these other sources can also be significantly reduced.

To maximize noise performance in a given application, use a 0.47- μF noise-reduction capacitor plus a 0.47- μF bypass capacitor.

BOARD LAYOUT RECOMMENDATIONS TO IMPROVE PSRR AND NOISE PERFORMANCE

To improve ac performance such as PSRR, output noise, and transient response, it is recommended that the board be designed with separate ground planes for V_{IN} and V_{OUT} , with each ground plane connected only at the GND pin of the device. In addition, the ground connection for the bypass capacitor should connect directly to the GND pin of the device.

INTERNAL CURRENT LIMIT

The TPS7A8101 internal current limit helps protect the regulator during fault conditions. During current limit, the output sources a fixed amount of current that is largely independent of output voltage. For reliable operation, the device should not be operated in a current limit state for extended periods of time.

The PMOS pass element in the TPS7A8101 has a built-in body diode that conducts current when the voltage at OUT exceeds the voltage at IN. This current is not limited, so if extended reverse voltage operation is anticipated, external limiting may be appropriate.

SHUTDOWN

The enable pin (EN) is active high and is compatible with standard and low voltage, TTL-CMOS levels. When shutdown capability is not required, EN can be connected to IN.

DROPOUT VOLTAGE

The TPS7A8101 uses a PMOS pass transistor to achieve low dropout. When ($V_{\text{IN}} - V_{\text{OUT}}$) is less than the dropout voltage (V_{DO}), the PMOS pass device is in its linear region of operation and the input-to-output resistance is the $R_{\text{DS(ON)}}$ of the PMOS pass element. V_{DO} scales approximately with output current because the PMOS device in dropout behaves the same way as a resistor.

As with any linear regulator, PSRR and transient response are degraded as ($V_{\text{IN}} - V_{\text{OUT}}$) approaches dropout. This effect is shown in [Figure 20](#) and [Figure 21](#) in the *Typical Characteristics* section.

STARTUP

Through a lower resistance, the bandgap reference can quickly charge the noise reduction capacitor (C_{NR}). The TPS7A8101 has a *quick-start* circuit to quickly charge C_{NR} , if present; see the [Functional Block Diagrams](#). At startup, this quick-start switch is closed, with only 33 k Ω of resistance between the bandgap reference and the NR pin. The quick-start switch opens approximately 100 ms after any device enabling event, and the resistance between the bandgap reference and the NR pin becomes higher in value (approximately 250 k Ω) to form a very good low-pass (RC) filter. This low-pass filter achieves very good noise reduction for the reference voltage.

Inrush current can be a problem in many applications. The 33-k Ω resistance during the startup period is intentionally put there to slow down the reference voltage ramp up, thus reducing the inrush current. For example, the capacitance of connecting the recommended C_{NR} value of 0.47 μ F along with the 33-k Ω resistance causes approximately 80-ms RC delay. Startup time with the other C_{NR} values can be calculated as:

$$t_{STR} (s) = 170,000 \times C_{NR} (F) \quad (2)$$

Although the noise reduction effect is nearly saturated at 0.47 μ F, connecting a C_{NR} value greater than 0.47 μ F can help reduce noise slightly more; however, startup time will be extremely long because the quick-start switch opens after approximately 100 ms. That is, if C_{NR} is not fully charged during this 100-ms period, C_{NR} finishes charging through a higher resistance of 250 k Ω , and takes much longer to fully charge.

Note that a low leakage C_{NR} should be used; most ceramic capacitors are suitable.

TRANSIENT RESPONSE

As with any regulator, increasing the size of the output capacitor reduces over/undershoot magnitude but increases duration of the transient response. Line transient performance can be improved by using a larger noise reduction capacitor (C_{NR}) and/or bypass capacitor (C_{BYPASS}).

UNDERVOLTAGE LOCK-OUT (UVLO)

The TPS7A8101 uses an undervoltage lock-out circuit to keep the output shut off until the internal circuitry is operating properly. The UVLO circuit has a de-glitch feature so that it typically ignores undershoot transients on the input if they are less than 50- μ s duration.

MINIMUM LOAD

The TPS7A8101 is stable and well-behaved with no output load. Traditional PMOS LDO regulators suffer from lower loop gain at very light output loads. The TPS7A8101 employs an innovative low-current mode circuit to increase loop gain under very light or no-load conditions, resulting in improved output voltage regulation performance down to zero output current.

THERMAL INFORMATION

Thermal Protection

Thermal protection disables the output when the junction temperature rises to approximately +160 $^{\circ}$ C, allowing the device to cool. When the junction temperature cools to approximately +140 $^{\circ}$ C the output circuitry is again enabled. Depending on power dissipation, thermal resistance, and ambient temperature, the thermal protection circuit may cycle on and off. This cycling limits the dissipation of the regulator, protecting it from damage because of overheating.

Any tendency to activate the thermal protection circuit indicates excessive power dissipation or an inadequate heatsink. For reliable operation, junction temperature should be limited to +125 $^{\circ}$ C maximum. To estimate the margin of safety in a complete design (including heatsink), increase the ambient temperature until the thermal protection is triggered; use worst-case loads and signal conditions. For good reliability, thermal protection should trigger at least +35 $^{\circ}$ C above the maximum expected ambient condition of your particular application. This configuration produces a worst-case junction temperature of +125 $^{\circ}$ C at the highest expected ambient temperature and worst-case load.

The internal protection circuitry of the TPS7A8101 has been designed to protect against overload conditions. It was not intended to replace proper heatsinking. Continuously running the TPS7A8101 into thermal shutdown degrades device reliability.

Power Dissipation

Knowing the device power dissipation and proper sizing of the thermal plane that is connected to the tab or pad is critical to avoiding thermal shutdown and ensuring reliable operation.

Power dissipation of the device depends on input voltage and load conditions and can be calculated using Equation 3:

$$P_D = (V_{IN} - V_{OUT}) \times I_{OUT} \quad (3)$$

Power dissipation can be minimized and greater efficiency can be achieved by using the lowest possible input voltage necessary to achieve the required output voltage regulation.

On the SON (DRB) package, the primary conduction path for heat is through the exposed pad to the printed circuit board (PCB). The pad can be connected to ground or be left floating; however, it should be attached to an appropriate amount of copper PCB area to ensure the device does not overheat. The maximum junction-to-ambient thermal resistance depends on the maximum ambient temperature, maximum device junction temperature, and power dissipation of the device and can be calculated using Equation 4:

$$R_{\theta JA} = \frac{(+125^{\circ}\text{C} - T_A)}{P_D} \quad (4)$$

Knowing the maximum $R_{\theta JA}$, the minimum amount of PCB copper area needed for appropriate heatsinking can be estimated using Figure 32.

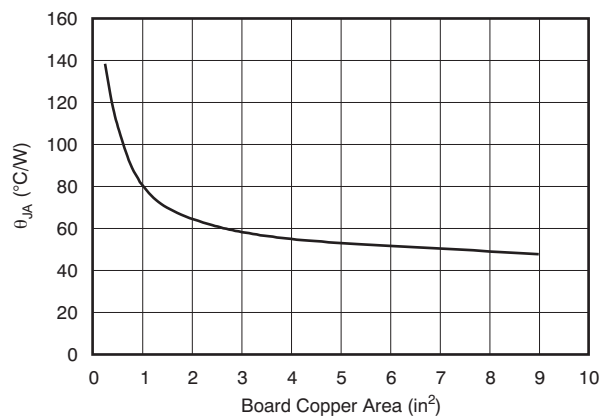

Note: θ_{JA} value at board size of 9 in² (that is, 3 in × 3 in) is a JEDEC standard.

Figure 32. θ_{JA} vs Board Size

Figure 32 shows the variation of θ_{JA} as a function of ground plane copper area in the board. It is intended only as a guideline to demonstrate the effects of heat spreading in the ground plane and should not be used to estimate actual thermal performance in real application environments.

NOTE: When the device is mounted on an application PCB, it is strongly recommended to use Ψ_{JT} and Ψ_{JB} , as explained in the *Estimating Junction Temperature* section.

Estimating Junction Temperature

Using the thermal metrics Ψ_{JT} and Ψ_{JB} , as shown in the *Thermal Information* table, the junction temperature can be estimated with corresponding formulas (given in Equation 5). For backwards compatibility, an older $\theta_{JC,Top}$ parameter is listed as well.

$$\Psi_{JT}: T_J = T_T + \Psi_{JT} \cdot P_D$$

$$\Psi_{JB}: T_J = T_B + \Psi_{JB} \cdot P_D \tag{5}$$

Where P_D is the power dissipation shown by Equation 4, T_T is the temperature at the center-top of the IC package, and T_B is the PCB temperature measured 1 mm away from the IC package on the PCB surface (as Figure 33 shows).

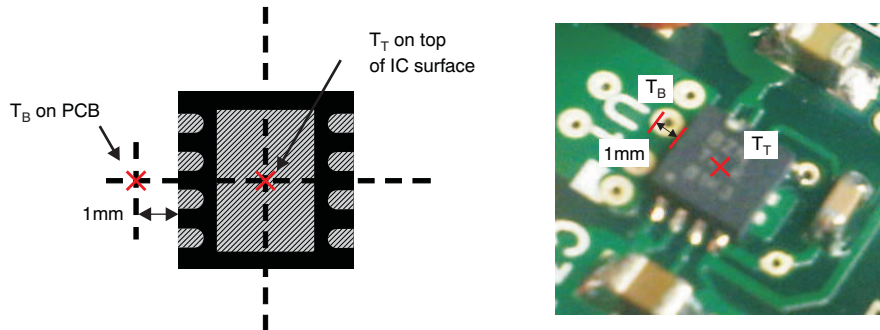

Figure 33. Measuring Points for T_T and T_B

NOTE: Both T_T and T_B can be measured on actual application boards using an infrared thermometer.

For more information about measuring T_T and T_B , see the application note [SBVA025, Using New Thermal Metrics](#), available for download at [www.ti.com](#).

By looking at Figure 34, the new thermal metrics (Ψ_{JT} and Ψ_{JB}) have very little dependency on board size. That is, using Ψ_{JT} or Ψ_{JB} with Equation 5 is a good way to estimate T_J by simply measuring T_T or T_B , regardless of the application board size.

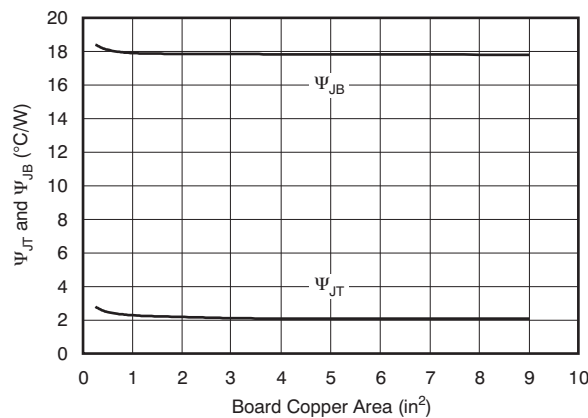

Figure 34. Ψ_{JT} and Ψ_{JB} vs Board Size

For a more detailed discussion of why TI does not recommend using $\theta_{JC(top)}$ to determine thermal characteristics, refer to application report [SBVA025, Using New Thermal Metrics](#), available for download at [www.ti.com](#). For further information, refer to application report [SPRA953, IC Package Thermal Metrics](#), also available on the TI website.

PACKAGING INFORMATION

Orderable Device	Status ⁽¹⁾	Package Type	Package Drawing	Pins	Package Qty	Eco Plan ⁽²⁾	Lead/ Ball Finish	MSL Peak Temp ⁽³⁾	Samples (Requires Login)
TPS7A8101DRBR	ACTIVE	SON	DRB	8	3000	Green (RoHS & no Sb/Br)	CU NIPDAU	Level-2-260C-1 YEAR	
TPS7A8101DRBT	ACTIVE	SON	DRB	8	250	Green (RoHS & no Sb/Br)	CU NIPDAU	Level-2-260C-1 YEAR	

⁽¹⁾ The marketing status values are defined as follows:

ACTIVE: Product device recommended for new designs.

LIFEBUY: TI has announced that the device will be discontinued, and a lifetime-buy period is in effect.

NRND: Not recommended for new designs. Device is in production to support existing customers, but TI does not recommend using this part in a new design.

PREVIEW: Device has been announced but is not in production. Samples may or may not be available.

OBSOLETE: TI has discontinued the production of the device.

⁽²⁾ Eco Plan - The planned eco-friendly classification: Pb-Free (RoHS), Pb-Free (RoHS Exempt), or Green (RoHS & no Sb/Br) - please check <http://www.ti.com/productcontent> for the latest availability information and additional product content details.

TBD: The Pb-Free/Green conversion plan has not been defined.

Pb-Free (RoHS): TI's terms "Lead-Free" or "Pb-Free" mean semiconductor products that are compatible with the current RoHS requirements for all 6 substances, including the requirement that lead not exceed 0.1% by weight in homogeneous materials. Where designed to be soldered at high temperatures, TI Pb-Free products are suitable for use in specified lead-free processes.

Pb-Free (RoHS Exempt): This component has a RoHS exemption for either 1) lead-based flip-chip solder bumps used between the die and package, or 2) lead-based die adhesive used between the die and leadframe. The component is otherwise considered Pb-Free (RoHS compatible) as defined above.

Green (RoHS & no Sb/Br): TI defines "Green" to mean Pb-Free (RoHS compatible), and free of Bromine (Br) and Antimony (Sb) based flame retardants (Br or Sb do not exceed 0.1% by weight in homogeneous material)

⁽³⁾ MSL, Peak Temp. -- The Moisture Sensitivity Level rating according to the JEDEC industry standard classifications, and peak solder temperature.

Important Information and Disclaimer: The information provided on this page represents TI's knowledge and belief as of the date that it is provided. TI bases its knowledge and belief on information provided by third parties, and makes no representation or warranty as to the accuracy of such information. Efforts are underway to better integrate information from third parties. TI has taken and continues to take reasonable steps to provide representative and accurate information but may not have conducted destructive testing or chemical analysis on incoming materials and chemicals. TI and TI suppliers consider certain information to be proprietary, and thus CAS numbers and other limited information may not be available for release.

In no event shall TI's liability arising out of such information exceed the total purchase price of the TI part(s) at issue in this document sold by TI to Customer on an annual basis.

DRB (S-PVSON-N8)

PLASTIC SMALL OUTLINE NO-LEAD

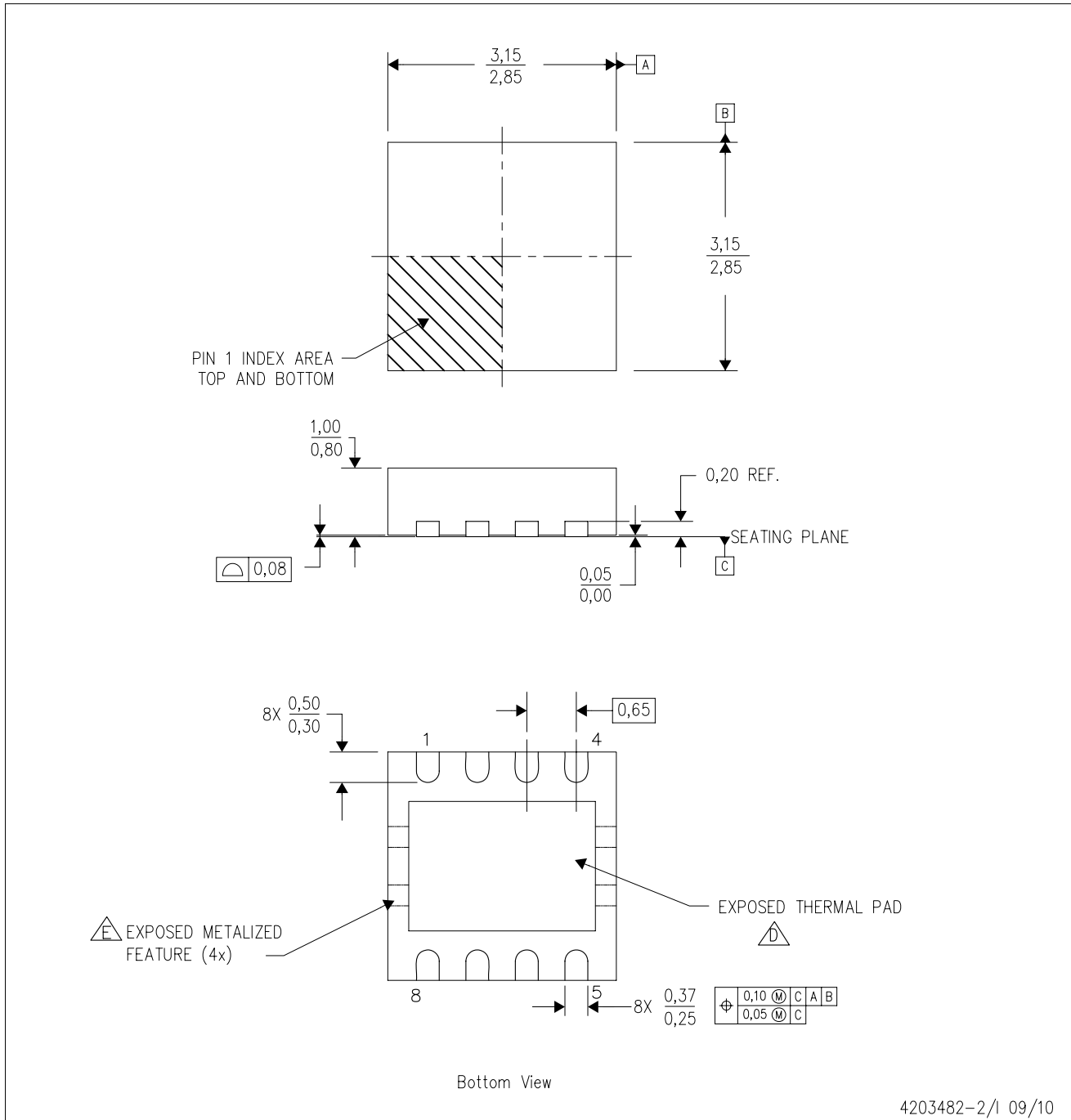

- NOTES:
- A. All linear dimensions are in millimeters. Dimensioning and tolerancing per ASME Y14.5M-1994.
 - B. This drawing is subject to change without notice.
 - C. Small Outline No-Lead (SON) package configuration.
 - The package thermal pad must be soldered to the board for thermal and mechanical performance.
 - See the Product Data Sheet for details regarding the exposed thermal pad features and dimensions.

IMPORTANT NOTICE

Texas Instruments Incorporated and its subsidiaries (TI) reserve the right to make corrections, modifications, enhancements, improvements, and other changes to its products and services at any time and to discontinue any product or service without notice. Customers should obtain the latest relevant information before placing orders and should verify that such information is current and complete. All products are sold subject to TI's terms and conditions of sale supplied at the time of order acknowledgment.

TI warrants performance of its hardware products to the specifications applicable at the time of sale in accordance with TI's standard warranty. Testing and other quality control techniques are used to the extent TI deems necessary to support this warranty. Except where mandated by government requirements, testing of all parameters of each product is not necessarily performed.

TI assumes no liability for applications assistance or customer product design. Customers are responsible for their products and applications using TI components. To minimize the risks associated with customer products and applications, customers should provide adequate design and operating safeguards.

TI does not warrant or represent that any license, either express or implied, is granted under any TI patent right, copyright, mask work right, or other TI intellectual property right relating to any combination, machine, or process in which TI products or services are used. Information published by TI regarding third-party products or services does not constitute a license from TI to use such products or services or a warranty or endorsement thereof. Use of such information may require a license from a third party under the patents or other intellectual property of the third party, or a license from TI under the patents or other intellectual property of TI.

Reproduction of TI information in TI data books or data sheets is permissible only if reproduction is without alteration and is accompanied by all associated warranties, conditions, limitations, and notices. Reproduction of this information with alteration is an unfair and deceptive business practice. TI is not responsible or liable for such altered documentation. Information of third parties may be subject to additional restrictions.

Resale of TI products or services with statements different from or beyond the parameters stated by TI for that product or service voids all express and any implied warranties for the associated TI product or service and is an unfair and deceptive business practice. TI is not responsible or liable for any such statements.

TI products are not authorized for use in safety-critical applications (such as life support) where a failure of the TI product would reasonably be expected to cause severe personal injury or death, unless officers of the parties have executed an agreement specifically governing such use. Buyers represent that they have all necessary expertise in the safety and regulatory ramifications of their applications, and acknowledge and agree that they are solely responsible for all legal, regulatory and safety-related requirements concerning their products and any use of TI products in such safety-critical applications, notwithstanding any applications-related information or support that may be provided by TI. Further, Buyers must fully indemnify TI and its representatives against any damages arising out of the use of TI products in such safety-critical applications.

TI products are neither designed nor intended for use in military/aerospace applications or environments unless the TI products are specifically designated by TI as military-grade or "enhanced plastic." Only products designated by TI as military-grade meet military specifications. Buyers acknowledge and agree that any such use of TI products which TI has not designated as military-grade is solely at the Buyer's risk, and that they are solely responsible for compliance with all legal and regulatory requirements in connection with such use.

TI products are neither designed nor intended for use in automotive applications or environments unless the specific TI products are designated by TI as compliant with ISO/TS 16949 requirements. Buyers acknowledge and agree that, if they use any non-designated products in automotive applications, TI will not be responsible for any failure to meet such requirements.

Following are URLs where you can obtain information on other Texas Instruments products and application solutions:

Products

Audio	www.ti.com/audio
Amplifiers	amplifier.ti.com
Data Converters	dataconverter.ti.com
DLP® Products	www.dlp.com
DSP	dsp.ti.com
Clocks and Timers	www.ti.com/clocks
Interface	interface.ti.com
Logic	logic.ti.com
Power Mgmt	power.ti.com
Microcontrollers	microcontroller.ti.com
RFID	www.ti-rfid.com
OMAP Mobile Processors	www.ti.com/omap
Wireless Connectivity	www.ti.com/wirelessconnectivity

Applications

Communications and Telecom	www.ti.com/communications
Computers and Peripherals	www.ti.com/computers
Consumer Electronics	www.ti.com/consumer-apps
Energy and Lighting	www.ti.com/energy
Industrial	www.ti.com/industrial
Medical	www.ti.com/medical
Security	www.ti.com/security
Space, Avionics and Defense	www.ti.com/space-avionics-defense
Transportation and Automotive	www.ti.com/automotive
Video and Imaging	www.ti.com/video

TI E2E Community Home Page

e2e.ti.com

Mailing Address: Texas Instruments, Post Office Box 655303, Dallas, Texas 75265
Copyright © 2011, Texas Instruments Incorporated