

LOW INPUT VOLTAGE, 1-A LOW-DROPOUT LINEAR REGULATORS WITH SUPERVISOR

Check for Samples: [TPS726126](#), [TPS72615](#), [TPS72616](#), [TPS72618](#), [TPS72625](#)

FEATURES

- 1-A Low-Dropout Regulator Supports Input Voltages Down to 1.8-V
- Available in 1.26-V, 1.5-V, 1.6-V, 1.8-V, 2.5-V
- Stable With Any Type/Value Output Capacitor
- $\pm 2\%$ Output Voltage Tolerance Over Line, Load, and Temperature (-40°C to $+125^{\circ}\text{C}$)
- Integrated Supervisor (SVS) With 200-ms RESET Delay Time
- Low 170-mV Dropout Voltage at 1 A (TPS72625)
- Low 210- μA Ground Current at Full Load
- Less than 1- μA Standby Current
- Integrated UVLO with Thermal and Overcurrent Protection
- 5-Lead SOT223 or DPAK Surface-Mount Package

APPLICATIONS

- PCI Cards
- Modem Banks and Telecom Boards
- DSP, FPGA, and Microprocessor Power Supplies
- Portable, Battery-Powered Applications
- 1.26-V Core Voltage for the Following DSPs:
 - TMS320vC5501
 - TMS320vC5502

DESCRIPTION

The TPS726xx family of 1-A low-dropout (LDO) linear regulators has fixed voltage options available that are commonly used to power the latest DSPs, FPGAs, and microcontrollers. The integrated supervisory circuitry provides an active low RESET signal when the output falls out of regulation. The no capacitor/any capacitor feature allows the customer to tailor output transient performance as needed. Therefore, compared to other regulators capable of providing the same output current, this family of regulators can provide a stand alone power supply solution or a post regulator for a switch mode power supply.

These regulators operate over a wide range of input voltages (1.8 V to 6 V) and have very low dropout (170 mV at 1-A). Ground current is typically 210 μA at full load and drops to less than 80 μA at no load. Standby current is less than 1 μA .

Unlike some regulators that have a minimum current requirement, the TPS726xx family is stable with no output load current. The low noise capability of this family, coupled with its high current operation and ease of power dissipation, make it ideal for telecom boards, modem banks, and other noise sensitive applications.

The TPS726xx is available in either a SOT223 or DPAK package. The TPS726126 is available in a SOT223 package only.

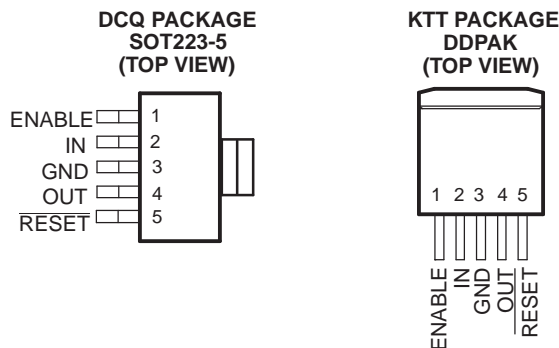

Note: Tab is GND for both packages



Please be aware that an important notice concerning availability, standard warranty, and use in critical applications of Texas Instruments semiconductor products and disclaimers thereto appears at the end of this data sheet.



This integrated circuit can be damaged by ESD. Texas Instruments recommends that all integrated circuits be handled with appropriate precautions. Failure to observe proper handling and installation procedures can cause damage.

ESD damage can range from subtle performance degradation to complete device failure. Precision integrated circuits may be more susceptible to damage because very small parametric changes could cause the device not to meet its published specifications.

ORDERING INFORMATION⁽¹⁾

PRODUCT	V _{OUT}
TPS726xx <i>xyyy</i> z	XXX is nominal output voltage (for example, 126 = 1.26V, 15 = 1.5V). YYY is package designator. Z is package quantity.

(1) For the most current package and ordering information, see the Package Option Addendum at the end of this document, or see the TI website at www.ti.com.

ABSOLUTE MAXIMUM RATINGS

over operating free-air temperature range unless otherwise noted⁽¹⁾

		UNIT
Input voltage, V _I ⁽²⁾	-0.3 to 7	V
Voltage range at EN	-0.3 to V _I + 0.3	V
Voltage on $\overline{\text{RESET}}$	V _{IN} + 0.3	V
Voltage on OUT	6	V
ESD rating, HBM	2	kV
Continuous total power dissipation	See Dissipation Rating Table	
Operating junction temperature range, T _J	-50 to 150	°C
Maximum junction temperature range, T _J	150	°C
Storage temperature, T _{stg}	-65 to 150	°C

(1) Stresses beyond those listed under *absolute maximum ratings* may cause permanent damage to the device. These are stress ratings only, and functional operation of the device at these or any other conditions beyond those indicated under *recommended operating conditions* is not implied. Exposure to absolute-maximum-rated conditions for extended periods may affect device reliability.

(2) All voltage values are with respect to network ground terminal.

PACKAGE DISSIPATION RATINGS

PACKAGE	BOARD	R _{θJC}	R _{θJA}
DDPAK	High K ⁽¹⁾	2 °C/W	23 °C/W
SOT223	Low K ⁽²⁾	15 °C/W	53 °C/W

(1) The JEDEC high K (2s2p) board design used to derive this data was a 3-inch x 3-inch (7,5-cm x 7,5-cm), multilayer board with 1 ounce internal power and ground planes and 2 ounce copper traces on top and bottom of the board.

(2) The JEDEC low K (1s) board design used to derive this data was a 3-inch x 3-inch (7,5-cm x 7,5-cm), two-layer board with 2 ounce copper traces on top of the board.

ELECTRICAL CHARACTERISTICS

over recommended operating free-air temperature range $V_I = V_{O(\text{typ})} + 1 \text{ V}$, $I_O = 1 \text{ mA}$, $EN = IN$, $C_O = 1 \mu\text{F}$, $C_I = 1 \mu\text{F}$ (unless otherwise noted). Typical values are at +25°C.

PARAMETER		TEST CONDITIONS		MIN	TYP	MAX	UNIT	
V_I ⁽¹⁾	Input voltage			1.8		6	V	
I_O	Continuous output current			0		1	A	
	Bandgap voltage reference			1.177	1.220	1.263	V	
V_O	Output voltage	TPS726126	$0 \mu\text{A} < I_O < 1 \text{ A}$	$1.8 \text{ V} \leq V_I \leq 5.5 \text{ V}$	1.222	1.26	1.298	V
		TPS72615	$0 \mu\text{A} < I_O < 1 \text{ A}$	$1.8 \text{ V} \leq V_I \leq 5.5 \text{ V}$	1.47	1.5	1.53	
		TPS72616	$0 \mu\text{A} < I_O < 1 \text{ A}$	$2.6 \text{ V} \leq V_I \leq 5.5 \text{ V}$	1.568	1.6	1.632	
		TPS72618	$0 \mu\text{A} < I_O < 1 \text{ A}$	$2.8 \text{ V} \leq V_I \leq 5.5 \text{ V}$	1.764	1.8	1.836	
		TPS72625	$0 \mu\text{A} < I_O < 1 \text{ A}$	$3.5 \text{ V} \leq V_I \leq 5.5 \text{ V}$	2.45	2.5	2.55	
I	Ground current	$I_O = 0 \mu\text{A}$			75	120	μA	
		$I_O = 1 \text{ A}$			210	300		
	Standby current	$EN < 0.4 \text{ V}$			0.2	1	μA	
V_n	Output noise voltage	$BW = 200 \text{ Hz to } 100 \text{ kHz}$	$C_O = 10 \mu\text{F}$		150		μV	
PSRR	Ripple rejection	$f = 1 \text{ kHz}, C_O = 10 \mu\text{F}$			60		dB	
	Current limit ⁽²⁾			1.1	1.6	2.3	A	
	Output voltage line regulation $(\Delta V_O/V_O)$ ⁽³⁾	$V_O + 1 \text{ V} < V_I \leq 5.5 \text{ V}$		-0.15	0.02	0.15	%/V	
	Output voltage load regulation	$0 \mu\text{A} < I_O < 1 \text{ A}$		-0.25	0.05	0.25	%/A	
V_{IH}	EN high level input			1.3			V	
V_{IL}	EN low level input			-0.2		0.4		
I_I	EN input current	$EN = 0 \text{ V or } V_I$			0.01	100	nA	
	UVLO threshold	V_{CC} rising		1.45	1.57	1.70	V	
	UVLO hysteresis	V_{CC} rising			50		mV	
	UVLO deglitch	V_{CC} rising			10		μs	
	UVLO delay	V_{CC} rising			100		μs	
V_{DO}	Dropout voltage ⁽⁴⁾	TPS72625	$I_O = 1 \text{ A}$		170	280	mV	
		TPS72618	$I_O = 1 \text{ A}$		210	320		
RESET	Minimum input voltage for valid RESET (V_{RES})				1.3		V	
	Trip threshold voltage				90	93	96	% V_O
	Hysteresis voltage					10		mV
	$t_{(\text{RESET})}$ delay time				100	200	300	ms
	Rising edge deglitch					10		μs
	Output low voltage (at 700 μA)				-0.3		0.4	V
	Leakage current						100	nA
T_J	Operating junction temperature			-40		+125	°C	

(1) Minimum V_{IN} is 1.800 V or $V_O + V_{DO}$, whichever is greater.

(2) Test condition includes, output voltage $V_O = V_O - 15\%$ and pulse duration = 10 ms.

(3) $V_{I\text{min}} = (V_O + 1)$ or 1.8 V whichever is greater.

$$\text{Line regulation (mV)} = (\%/\text{V}) \times \frac{V_O(5.5 \text{ V} - V_{I\text{min}})}{100} \times 1000$$

(4) Dropout voltage is defined as the differential voltage between V_O and V_I when V_O drops 100 mV below the value measured with $V_I = V_O + 1 \text{ V}$.

FUNCTIONAL BLOCK DIAGRAM

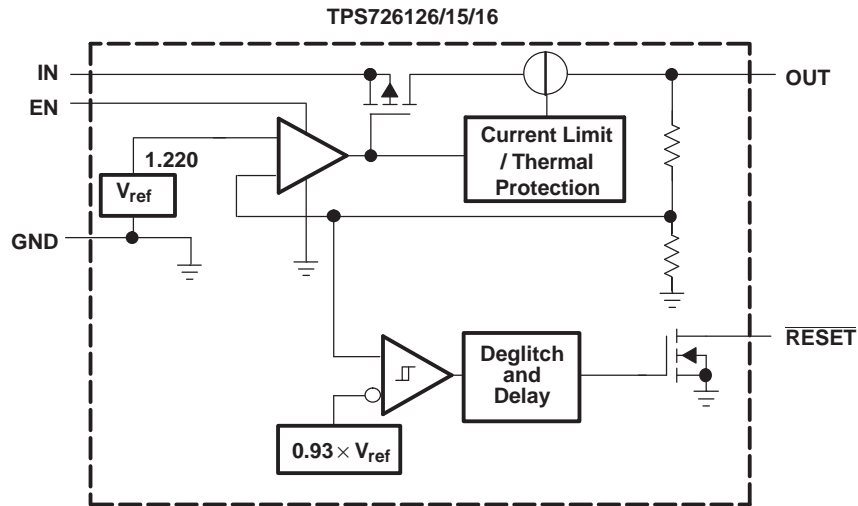

Terminal Functions

TERMINAL NAME	NO.	DESCRIPTION
GND	3	Ground
ENABLE	1	Enable input
IN	2	Input supply voltage
$\overline{\text{RESET}}$	5	This terminal is the $\overline{\text{RESET}}$ output. When used with a pull-up resistor, this open-drain output provides the active low $\overline{\text{RESET}}$ signal when the regulator output voltage drops more than 5% below its nominal output voltage. The $\overline{\text{RESET}}$ delay time is typically 200 ms.
OUT	4	Regulated output voltage

$\overline{\text{RESET}}$ TIMING DIAGRAM

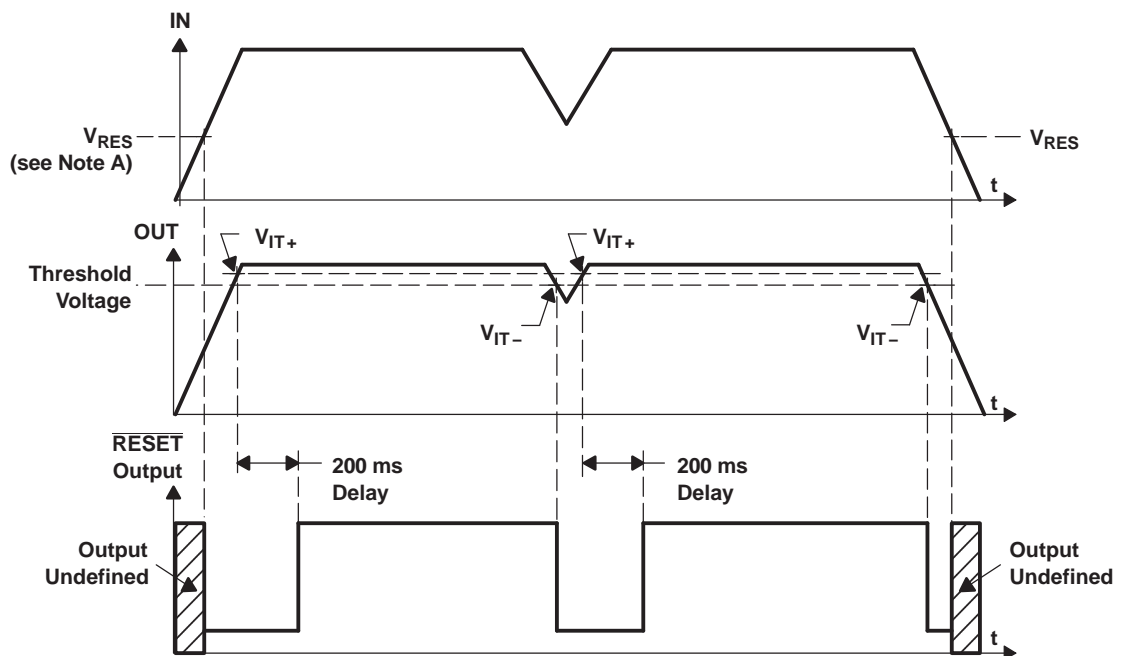

NOTES:A. V_{RES} is the minimum input voltage for a valid $\overline{\text{RESET}}$.

TYPICAL CHARACTERISTICS

TPS72618 OUTPUT VOLTAGE vs OUTPUT CURRENT

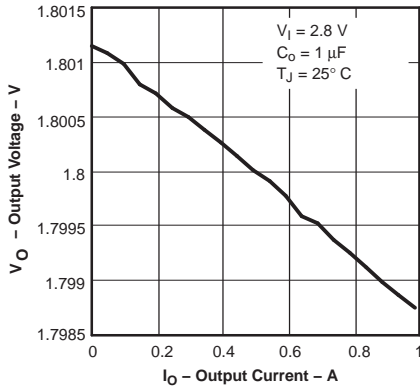

Figure 1.

TPS72618 OUTPUT VOLTAGE vs JUNCTION TEMPERATURE

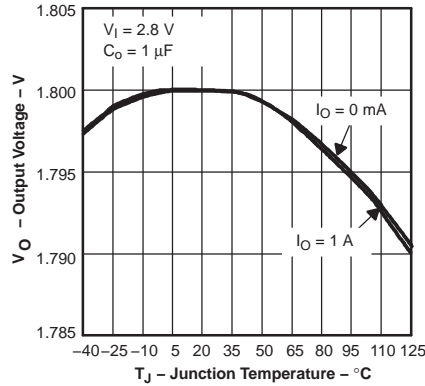

Figure 2.

TPS72618 GROUND CURRENT vs JUNCTION TEMPERATURE

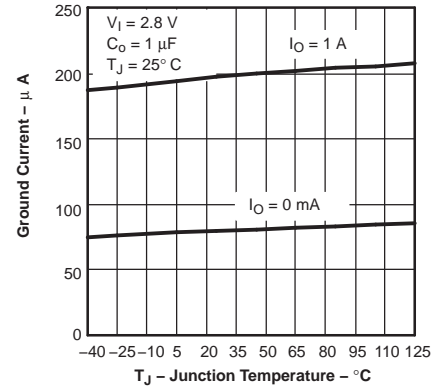

Figure 3.

TPS72618 GROUND CURRENT vs OUTPUT CURRENT

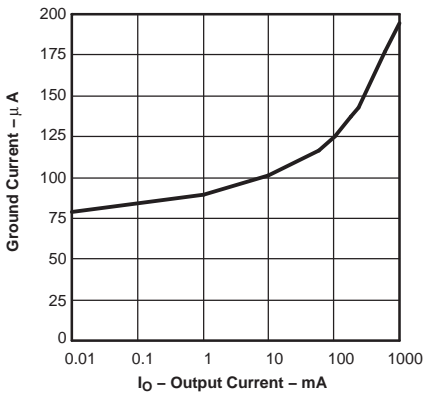

Figure 4.

TPS72625 DC DROPOUT VOLTAGE vs OUTPUT CURRENT

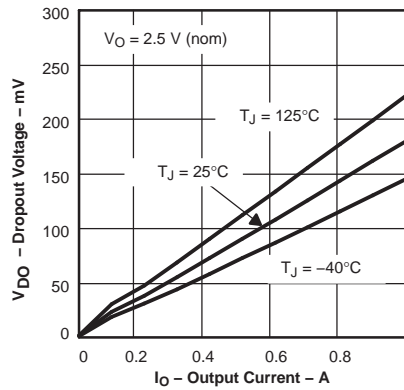

Figure 5.

TPS72618 DROPOUT VOLTAGE vs JUNCTION TEMPERATURE

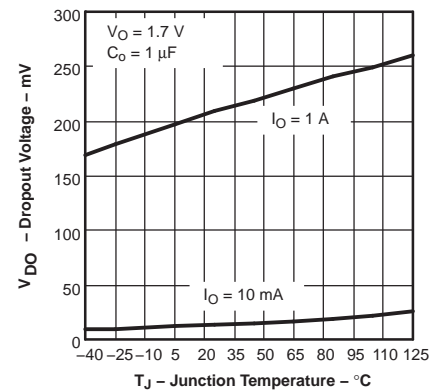

Figure 6.

TYPICAL CHARACTERISTICS (continued)

MINIMUM REQUIRED
 INPUT VOLTAGE
 vs
 OUTPUT VOLTAGE

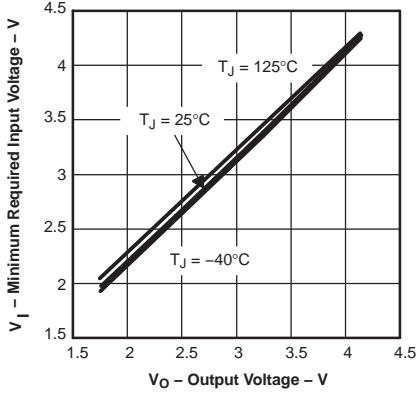

Figure 7.

TPS72618
 LINE TRANSIENT
 RESPONSE

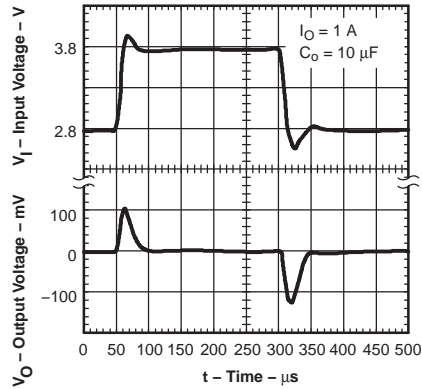

Figure 8.

TPS72618
 LOAD TRANSIENT
 RESPONSE

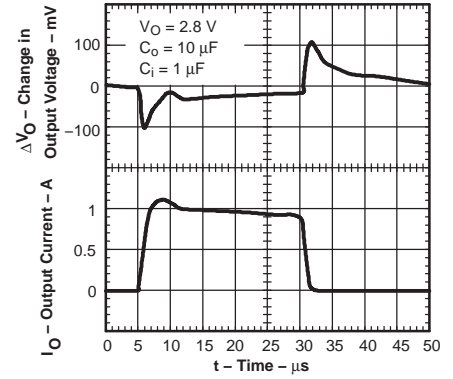

Figure 9.

TPS72618
 LOAD TRANSIENT
 RESPONSE

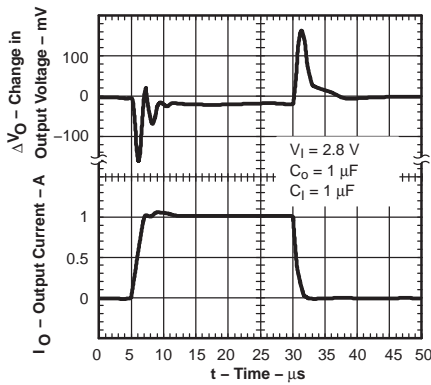

Figure 10.

TPS72618
 OUTPUT VOLTAGE,
 ENABLE VOLTAGE
 vs
 TIME (START-UP)

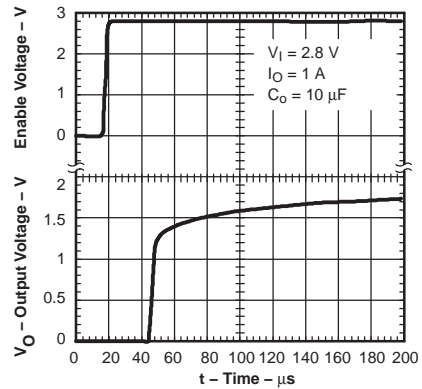

Figure 11.

TPS72618
 POWER UP/POWER DOWN

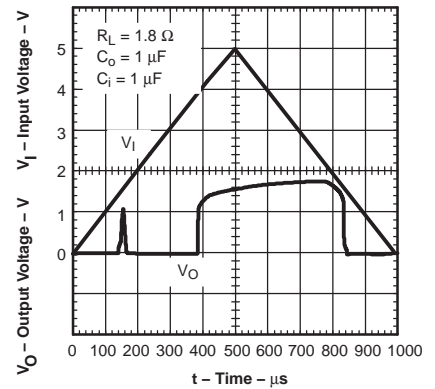

Figure 12.

TYPICAL CHARACTERISTICS (continued)

TPS72618
OUTPUT SPECTRAL NOISE
DENSITY
vs
FREQUENCY

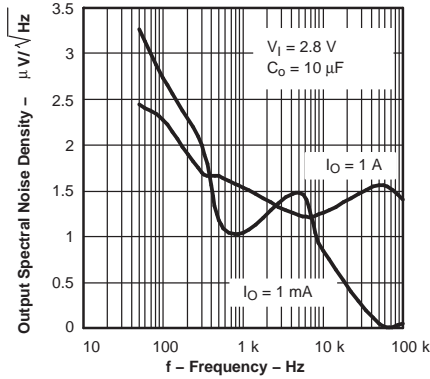

Figure 13.

TPS72618
RIPPLE REJECTION
vs
FREQUENCY

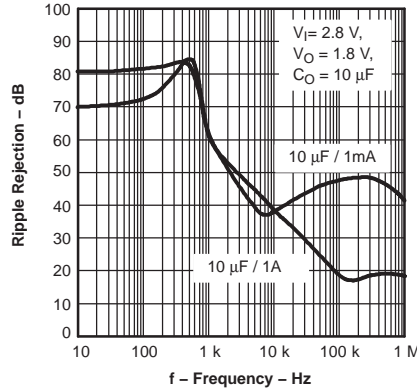

Figure 14.

CURRENT LIMIT
vs
INPUT VOLTAGE

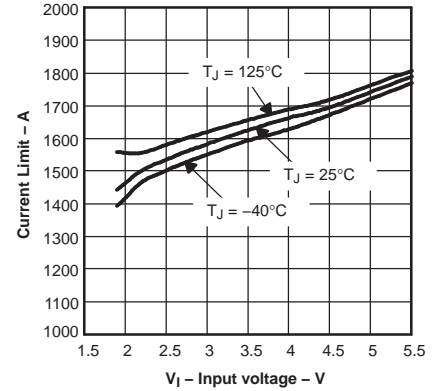

Figure 15.

TPS72615
GROUND CURRENT
vs
INPUT VOLTAGE

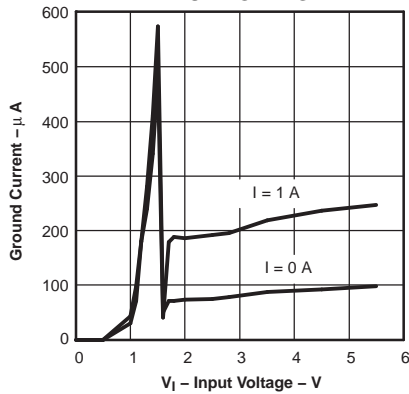

Figure 16.

DROPOUT VOLTAGE
vs
INPUT VOLTAGE

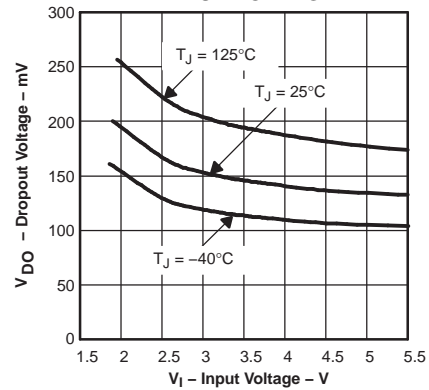

Figure 17.

APPLICATION INFORMATION

The TPS726xx family of low-dropout (LDO) regulators have numerous features that make it apply to a wide range of applications. The family operates with very low input voltage (≥ 1.8 V) and low dropout voltage (typically 200 mV at full load), making it an efficient stand-alone power supply or post regulator for battery or switch mode power supplies. Both the active low RESET and 1-A output current, make the TPS726xx family ideal for powering processor and FPGA supplies. The TPS726xx family also has low output noise (typically $150 \mu\text{V}_{\text{RMS}}$ with 10- μF output capacitor), making it ideal for use in telecom equipment.

External Capacitor Requirements

A 1- μF or larger ceramic input bypass capacitor, connected between IN and GND and located close to the TPS726xx, is required for stability. To improve transient response, noise rejection, and ripple rejection, an additional 10- μF or larger, low ESR capacitor is recommended. A higher-value, low ESR input capacitor may be necessary if large, fast-rise-time load transients are anticipated and the device is located several inches from the power source, especially if the minimum input voltage of 1.8 V is used.

Although an output capacitor is not required for stability, transient response and output noise are improved with a 10- μF output capacitor.

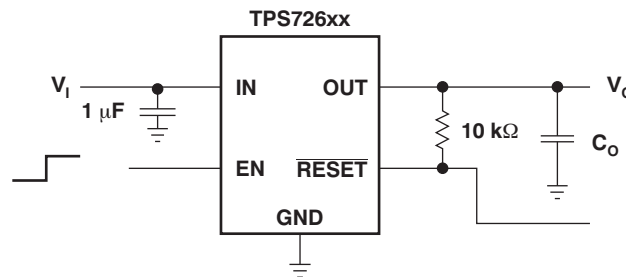

Figure 18. TPS726xx Fixed Output Typical Application Diagram

Regulator Protection

The TPS726xx pass element has a built-in back diode that safely conducts reverse current when the input voltage drops below the output voltage (e.g., during power down). Current is conducted from the output to the input and is not internally limited. If extended reverse voltage is anticipated, external limiting might be appropriate.

The TPS726xx also features internal current limiting and thermal protection. During normal operation, the TPS726xx limits output current to approximately 1.6 A. When current limiting engages, the output voltage scales back linearly until the overcurrent condition ends. While current limiting is designed to prevent gross device failure, care should be taken not to exceed the power dissipation ratings of the package. If the temperature of the device exceeds 165°C , thermal-protection circuitry shuts it down. Once the device has cooled down to below 145°C , regulator operation resumes.

THERMAL INFORMATION

The amount of heat that an LDO linear regulator generates is directly proportional to the amount of power it dissipates during operation. All integrated circuits have a maximum allowable junction temperature (T_{Jmax}) above which normal operation is not assured. A system designer must design the operating environment so that the operating junction temperature (T_{J}) does not exceed the maximum junction temperature (T_{Jmax}). The two main environmental variables that a designer can use to improve thermal performance are air flow and external heatsinks. The purpose of this information is to aid the designer in determining the proper operating environment for a linear regulator that is operating at a specific power level.

In general, the maximum expected power ($P_{D(max)}$) consumed by a linear regulator is computed as:

$$P_{Dmax} = (V_{I(avg)} - V_{O(avg)}) \times I_{O(avg)} + V_{I(avg)} \times I_{(Q)} \quad (1)$$

Where:

- $V_{I(avg)}$ is the average input voltage.
- $V_{O(avg)}$ is the average output voltage.
- $I_{O(avg)}$ is the average output current.
- $I_{(Q)}$ is the quiescent current.

For most TI LDO regulators, the quiescent current is insignificant compared to the average output current; therefore, the term $V_{I(avg)} \times I_{(Q)}$ can be neglected. The operating junction temperature is computed by adding the ambient temperature (T_A) and the increase in temperature due to the regulator's power dissipation. The temperature rise is computed by multiplying the maximum expected power dissipation by the sum of the thermal resistances between the junction and the case ($R_{\theta JC}$), the case to heatsink ($R_{\theta CS}$), and the heatsink to ambient ($R_{\theta SA}$). Thermal resistances are measures of how effectively an object dissipates heat. Typically, the larger the device, the more surface area available for power dissipation and the lower the object's thermal resistance.

Figure 19 illustrates these thermal resistances for (a) a SOT223 package mounted in a JEDEC low-K board, and (b) a DDPAK package mounted on a JEDEC high-K board.

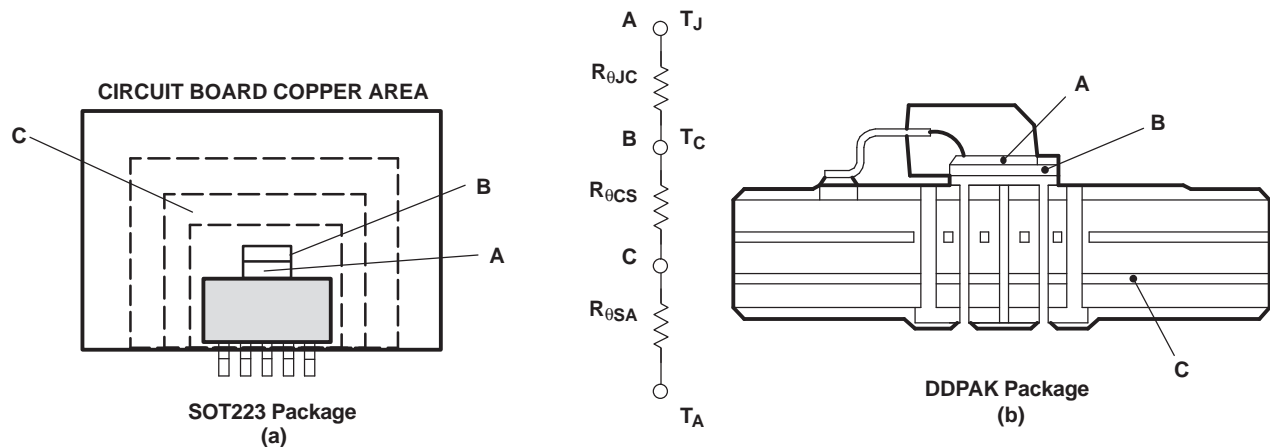

Figure 19. Thermal Resistances

Equation 2 summarizes the computation:

$$T_J = T_A + P_{Dmax} \times (R_{\theta JC} + R_{\theta CS} + R_{\theta SA}) \quad (2)$$

The $R_{\theta JC}$ is specific to each regulator as determined by its package, lead frame, and die size provided in the regulator's data sheet. The $R_{\theta SA}$ is a function of the type and size of heatsink. For example, *black body radiator* type heatsinks can have $R_{\theta CS}$ values ranging from 5°C/W for very large heatsinks to 50°C/W for very small heatsinks. The $R_{\theta CS}$ is a function of how the package is attached to the heatsink. For example, if a thermal compound is used to attach a heatsink to a SOT223 package, $R_{\theta CS}$ of 1°C/W is reasonable.

Even if no external *black body radiator* type heatsink is attached to the package, the board on which the regulator is mounted provides some heatsinking through the pin solder connections. Some packages, like the DDPAK and SOT223 packages, use a copper plane underneath the package or the circuit board's ground plane for additional heatsinking to improve their thermal performance. Computer-aided thermal modeling can be used to compute very accurate approximations of an integrated circuit's thermal performance in different operating environments (e.g., different types of circuit boards, different types and sizes of heatsinks, and different air flows, etc.). Using these models, the three thermal resistances can be combined into one thermal resistance between junction and ambient ($R_{\theta JA}$). This $R_{\theta JA}$ is valid only for the specific operating environment used in the computer model.

Equation 2 simplifies into Equation 3:

$$T_J = T_A + P_{D\max} \times R_{\theta JA} \quad (3)$$

Rearranging Equation 3 gives Equation 4:

$$R_{\theta JA} = \frac{T_J - T_A}{P_{D\max}} \quad (4)$$

Using Equation 3 and the computer model generated curves shown in Figure 20 and Figure 23, a designer can quickly compute the required heatsink thermal resistance/board area for a given ambient temperature, power dissipation, and operating environment.

DDPAK Power Dissipation

The DDPACK package provides an effective means of managing power dissipation in surface mount applications. The DDPACK package dimensions are provided in the *Mechanical Data* section at the end of the data sheet. The addition of a copper plane directly underneath the DDPACK package enhances the thermal performance of the package.

To illustrate, the TPS72625 in a DDPACK package was chosen. For this example, the average input voltage is 5 V, the output voltage is 2.5 V, the average output current is 1 A, the ambient temperature 55°C, the air flow is 150 LFM, and the operating environment is the same as documented below. Neglecting the quiescent current, the maximum average power is:

$$P_{D\max} = (5 - 2.5) \text{ V} \times 1 \text{ A} = 2.5 \text{ W} \quad (5)$$

Substituting $T_{J\max}$ for T_J into Equation 4 gives Equation 6:

$$R_{\theta JA\max} = (125 - 55)^\circ\text{C} / 2.5 \text{ W} = 28^\circ\text{C/W} \quad (6)$$

From Figure 20, *DDPAK Thermal Resistance vs Copper Heatsink Area*, the ground plane needs to be 1 cm² for the part to dissipate 2.5 W. The operating environment used in the computer model to construct Figure 20 consisted of a standard JEDEC High-K board (2S2P) with a 1 oz. internal copper plane and ground plane. The package is soldered to a 2 oz. copper pad. The pad is tied through thermal vias to the 1 oz. ground plane. Figure 21 shows the side view of the operating environment used in the computer model.

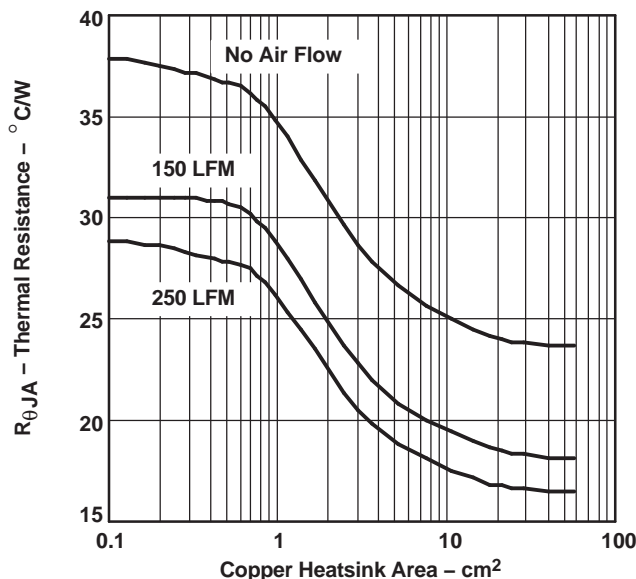

Figure 20. DDPACK Thermal Resistance vs Copper Heatsink Area

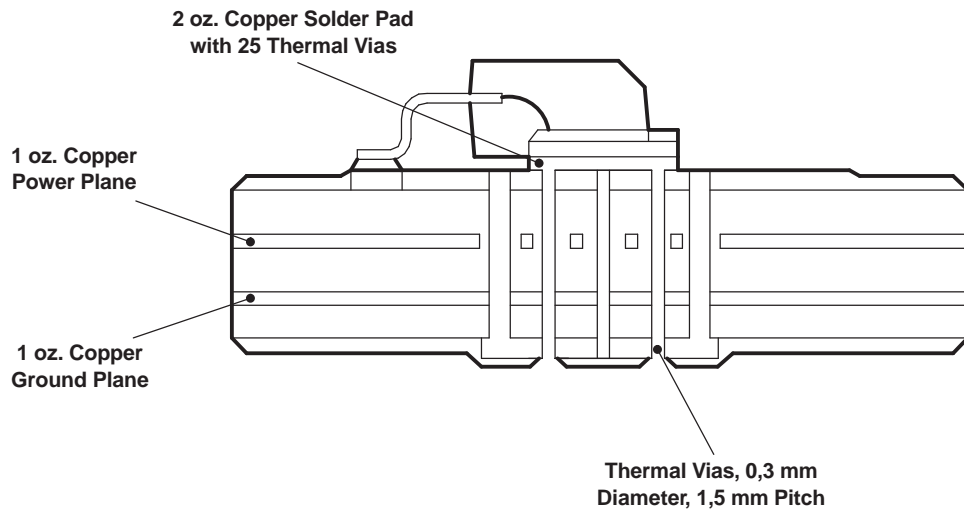

Figure 21. DPAK Thermal Resistance

From the data in Figure 22 and rearranging Equation 4, the maximum power dissipation for a different ground plane area and a specific ambient temperature can be computed.

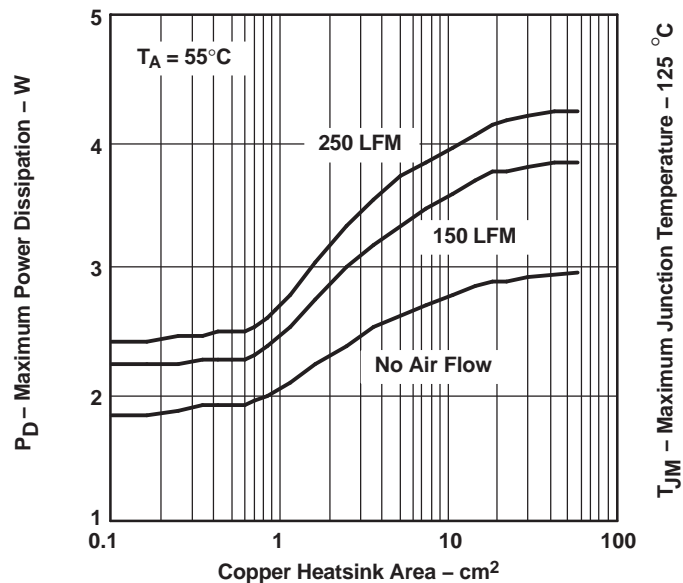

Figure 22. Maximum Power Dissipation vs Copper Heatsink Area

SOT223 Power Dissipation

The SOT223 package provides an effective means of managing power dissipation in surface mount applications. The SOT223 package dimensions are provided in the *Mechanical Data* section at the end of the data sheet. The addition of a copper plane directly underneath the SOT223 package enhances the thermal performance of the package.

To illustrate, the TPS72625 in a SOT223 package was chosen. For this example, the average input voltage is 3.3 V, the output voltage is 2.5 V, the average output current is 1 A, the ambient temperature 55°C, no air flow is present, and the operating environment is the same as documented below. Neglecting the quiescent current, the maximum average power is:

$$P_{D,max} = (3.3 - 2.5) V \times 1 A = 800 \text{ mW} \quad (7)$$

Substituting $T_{j,max}$ for T_j into Equation 4 gives Equation 8:

$$R_{\theta JA}^{\max} = (125 - 55)^{\circ}\text{C}/800 \text{ mW} = 87.5^{\circ}\text{C}/\text{W} \quad (8)$$

From Figure 23, $R_{\theta JA}$ vs PCB Copper Area, the ground plane needs to be 0.55 in² for the part to dissipate 800 mW. The operating environment used to construct Figure 23 consisted of a board with 1 oz. copper planes. The package is soldered to a 1 oz. copper pad on the top of the board. The pad is tied through thermal vias to the 1 oz. ground plane.

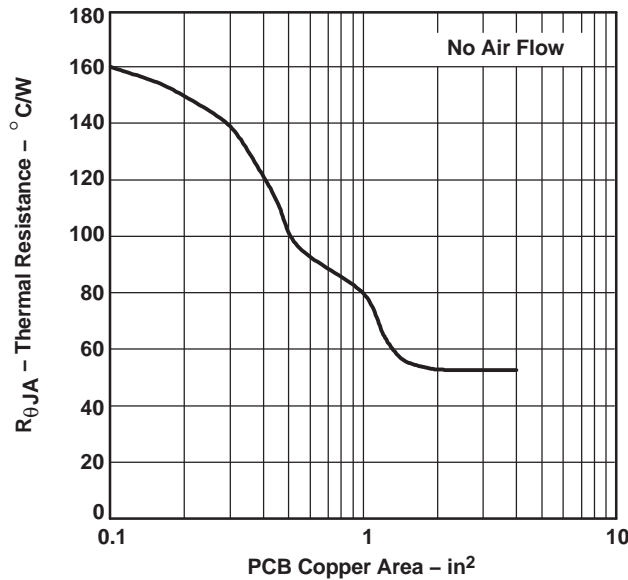

Figure 23. SOT223 Thermal Resistance vs PCB AREA

From the data in Figure 23 and rearranging Equation 4, the maximum power dissipation for a different ground plane area and a specific ambient temperature can be computed (as shown in Figure 24).

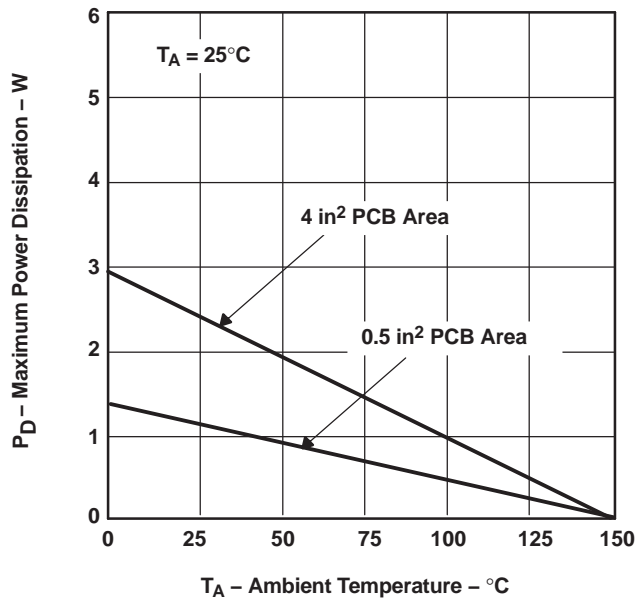

Figure 24. SOT223 Power Dissipation

REVISION HISTORY

NOTE: Page numbers for previous revisions may differ from page numbers in the current version.

Changes from Revision G (May 2006) to Revision H	Page
• Deleted Figure 14, <i>Output Impedance vs Frequency</i>	7
• Added Figure 18	8

PACKAGING INFORMATION

Orderable Device	Status (1)	Package Type	Package Drawing	Pins	Package Qty	Eco Plan (2)	Lead/Ball Finish (6)	MSL Peak Temp (3)	Op Temp (°C)	Device Marking (4/5)	Samples
TPS726126DCQ	ACTIVE	SOT-223	DCQ	6	78	Green (RoHS & no Sb/Br)	CU NIPDAU	Level-2-260C-1 YEAR	-40 to 125	726126	Samples
TPS726126DCQG4	ACTIVE	SOT-223	DCQ	6	78	Green (RoHS & no Sb/Br)	CU NIPDAU	Level-2-260C-1 YEAR	-40 to 125	726126	Samples
TPS726126DCQR	ACTIVE	SOT-223	DCQ	6	2500	Green (RoHS & no Sb/Br)	CU NIPDAU	Level-2-260C-1 YEAR	-40 to 125	726126	Samples
TPS726126DCQRG4	ACTIVE	SOT-223	DCQ	6	2500	Green (RoHS & no Sb/Br)	CU NIPDAU	Level-2-260C-1 YEAR	-40 to 125	726126	Samples
TPS72615DCQ	ACTIVE	SOT-223	DCQ	6	78	Green (RoHS & no Sb/Br)	CU NIPDAU	Level-2-260C-1 YEAR	-40 to 125	PS72615	Samples
TPS72615DCQG4	ACTIVE	SOT-223	DCQ	6	78	Green (RoHS & no Sb/Br)	CU NIPDAU	Level-2-260C-1 YEAR	-40 to 125	PS72615	Samples
TPS72615DCQR	ACTIVE	SOT-223	DCQ	6	2500	Green (RoHS & no Sb/Br)	CU NIPDAU	Level-2-260C-1 YEAR	-40 to 125	PS72615	Samples
TPS72615KTT	OBSOLETE	DDPAK/ TO-263	KTT	5		TBD	Call TI	Call TI	-40 to 125		
TPS72615KTTR	ACTIVE	DDPAK/ TO-263	KTT	5	500	Green (RoHS & no Sb/Br)	CU SN	Level-2-260C-1 YEAR	-40 to 125	TPS 72615	Samples
TPS72615KTTRG3	ACTIVE	DDPAK/ TO-263	KTT	5	500	Green (RoHS & no Sb/Br)	CU SN	Level-2-260C-1 YEAR	-40 to 125	TPS 72615	Samples
TPS72615KTTT	ACTIVE	DDPAK/ TO-263	KTT	5	50	Green (RoHS & no Sb/Br)	CU SN	Level-2-260C-1 YEAR	-40 to 125	TPS 72615	Samples
TPS72615KTTTG3	ACTIVE	DDPAK/ TO-263	KTT	5	50	Green (RoHS & no Sb/Br)	CU SN	Level-2-260C-1 YEAR	-40 to 125	TPS 72615	Samples
TPS72616DCQ	ACTIVE	SOT-223	DCQ	6	78	Green (RoHS & no Sb/Br)	CU NIPDAU	Level-2-260C-1 YEAR	-40 to 125	PS72616	Samples
TPS72616DCQR	ACTIVE	SOT-223	DCQ	6	2500	Green (RoHS & no Sb/Br)	CU NIPDAU	Level-2-260C-1 YEAR	-40 to 125	PS72616	Samples
TPS72616KTT	OBSOLETE	DDPAK/ TO-263	KTT	5		TBD	Call TI	Call TI	-40 to 125		
TPS72616KTTR	ACTIVE	DDPAK/ TO-263	KTT	5	500	Green (RoHS & no Sb/Br)	CU SN	Level-2-260C-1 YEAR		TPS 72616	Samples
TPS72616KTTRG3	ACTIVE	DDPAK/ TO-263	KTT	5	500	Green (RoHS & no Sb/Br)	CU SN	Level-2-260C-1 YEAR		TPS 72616	Samples

Orderable Device	Status (1)	Package Type	Package Drawing	Pins	Package Qty	Eco Plan (2)	Lead/Ball Finish (6)	MSL Peak Temp (3)	Op Temp (°C)	Device Marking (4/5)	Samples
TPS72616KTTT	ACTIVE	DDPAK/ TO-263	KTT	5	50	Green (RoHS & no Sb/Br)	CU SN	Level-2-260C-1 YEAR	-40 to 125	TPS 72616	Samples
TPS72618DCQ	ACTIVE	SOT-223	DCQ	6	78	Green (RoHS & no Sb/Br)	CU NIPDAU	Level-2-260C-1 YEAR		PS72618	Samples
TPS72618DCQR	ACTIVE	SOT-223	DCQ	6	2500	Green (RoHS & no Sb/Br)	CU NIPDAU	Level-2-260C-1 YEAR		PS72618	Samples
TPS72618DCQRG4	ACTIVE	SOT-223	DCQ	6	2500	Green (RoHS & no Sb/Br)	CU NIPDAU	Level-2-260C-1 YEAR		PS72618	Samples
TPS72618KTT	OBSOLETE	DDPAK/ TO-263	KTT	5		TBD	Call TI	Call TI	-40 to 125		
TPS72618KTTR	ACTIVE	DDPAK/ TO-263	KTT	5	500	Green (RoHS & no Sb/Br)	CU SN	Level-2-260C-1 YEAR		TPS 72618	Samples
TPS72618KTTT	ACTIVE	DDPAK/ TO-263	KTT	5	50	Green (RoHS & no Sb/Br)	CU SN	Level-2-260C-1 YEAR	-40 to 125	TPS 72618	Samples
TPS72625DCQ	ACTIVE	SOT-223	DCQ	6	78	Green (RoHS & no Sb/Br)	CU NIPDAU	Level-2-260C-1 YEAR		PS72625	Samples
TPS72625DCQG4	ACTIVE	SOT-223	DCQ	6	78	Green (RoHS & no Sb/Br)	CU NIPDAU	Level-2-260C-1 YEAR		PS72625	Samples
TPS72625DCQR	ACTIVE	SOT-223	DCQ	6	2500	Green (RoHS & no Sb/Br)	CU NIPDAU	Level-2-260C-1 YEAR		PS72625	Samples
TPS72625KTT	OBSOLETE	DDPAK/ TO-263	KTT	5		TBD	Call TI	Call TI	-40 to 125		
TPS72625KTTT	ACTIVE	DDPAK/ TO-263	KTT	5	50	Green (RoHS & no Sb/Br)	CU SN	Level-2-260C-1 YEAR	-40 to 125	TPS 72625	Samples

(1) The marketing status values are defined as follows:

ACTIVE: Product device recommended for new designs.

LIFEBUY: TI has announced that the device will be discontinued, and a lifetime-buy period is in effect.

NRND: Not recommended for new designs. Device is in production to support existing customers, but TI does not recommend using this part in a new design.

PREVIEW: Device has been announced but is not in production. Samples may or may not be available.

OBSOLETE: TI has discontinued the production of the device.

(2) Eco Plan - The planned eco-friendly classification: Pb-Free (RoHS), Pb-Free (RoHS Exempt), or Green (RoHS & no Sb/Br) - please check <http://www.ti.com/productcontent> for the latest availability information and additional product content details.

TBD: The Pb-Free/Green conversion plan has not been defined.

Pb-Free (RoHS): TI's terms "Lead-Free" or "Pb-Free" mean semiconductor products that are compatible with the current RoHS requirements for all 6 substances, including the requirement that lead not exceed 0.1% by weight in homogeneous materials. Where designed to be soldered at high temperatures, TI Pb-Free products are suitable for use in specified lead-free processes.

Pb-Free (RoHS Exempt): This component has a RoHS exemption for either 1) lead-based flip-chip solder bumps used between the die and package, or 2) lead-based die adhesive used between the die and leadframe. The component is otherwise considered Pb-Free (RoHS compatible) as defined above.

Green (RoHS & no Sb/Br): TI defines "Green" to mean Pb-Free (RoHS compatible), and free of Bromine (Br) and Antimony (Sb) based flame retardants (Br or Sb do not exceed 0.1% by weight in homogeneous material)

⁽³⁾ MSL, Peak Temp. - The Moisture Sensitivity Level rating according to the JEDEC industry standard classifications, and peak solder temperature.

⁽⁴⁾ There may be additional marking, which relates to the logo, the lot trace code information, or the environmental category on the device.

⁽⁵⁾ Multiple Device Markings will be inside parentheses. Only one Device Marking contained in parentheses and separated by a "~" will appear on a device. If a line is indented then it is a continuation of the previous line and the two combined represent the entire Device Marking for that device.

⁽⁶⁾ Lead/Ball Finish - Orderable Devices may have multiple material finish options. Finish options are separated by a vertical ruled line. Lead/Ball Finish values may wrap to two lines if the finish value exceeds the maximum column width.

Important Information and Disclaimer: The information provided on this page represents TI's knowledge and belief as of the date that it is provided. TI bases its knowledge and belief on information provided by third parties, and makes no representation or warranty as to the accuracy of such information. Efforts are underway to better integrate information from third parties. TI has taken and continues to take reasonable steps to provide representative and accurate information but may not have conducted destructive testing or chemical analysis on incoming materials and chemicals. TI and TI suppliers consider certain information to be proprietary, and thus CAS numbers and other limited information may not be available for release.

In no event shall TI's liability arising out of such information exceed the total purchase price of the TI part(s) at issue in this document sold by TI to Customer on an annual basis.

TAPE AND REEL INFORMATION



QUADRANT ASSIGNMENTS FOR PIN 1 ORIENTATION IN TAPE



*All dimensions are nominal

Device	Package Type	Package Drawing	Pins	SPQ	Reel Diameter (mm)	Reel Width W1 (mm)	A0 (mm)	B0 (mm)	K0 (mm)	P1 (mm)	W (mm)	Pin1 Quadrant
TPS726126DCQR	SOT-223	DCQ	6	2500	330.0	12.4	7.1	7.45	1.88	8.0	12.0	Q3
TPS72615DCQR	SOT-223	DCQ	6	2500	330.0	12.4	7.1	7.45	1.88	8.0	12.0	Q3
TPS72615KTTR	DDPAK/ TO-263	KTT	5	500	330.0	24.4	10.6	15.6	4.9	16.0	24.0	Q2
TPS72615KTTT	DDPAK/ TO-263	KTT	5	50	330.0	24.4	10.6	15.6	4.9	16.0	24.0	Q2
TPS72616DCQR	SOT-223	DCQ	6	2500	330.0	12.4	7.1	7.45	1.88	8.0	12.0	Q3
TPS72616KTTR	DDPAK/ TO-263	KTT	5	500	330.0	24.4	10.6	15.6	4.9	16.0	24.0	Q2
TPS72616KTTT	DDPAK/ TO-263	KTT	5	50	330.0	24.4	10.6	15.6	4.9	16.0	24.0	Q2
TPS72618DCQR	SOT-223	DCQ	6	2500	330.0	12.4	7.1	7.45	1.88	8.0	12.0	Q3
TPS72618KTTR	DDPAK/ TO-263	KTT	5	500	330.0	24.4	10.6	15.6	4.9	16.0	24.0	Q2
TPS72618KTTT	DDPAK/ TO-263	KTT	5	50	330.0	24.4	10.6	15.6	4.9	16.0	24.0	Q2
TPS72625DCQR	SOT-223	DCQ	6	2500	330.0	12.4	7.1	7.45	1.88	8.0	12.0	Q3
TPS72625KTTT	DDPAK/ TO-263	KTT	5	50	330.0	24.4	10.6	15.6	4.9	16.0	24.0	Q2

TAPE AND REEL BOX DIMENSIONS

*All dimensions are nominal

Device	Package Type	Package Drawing	Pins	SPQ	Length (mm)	Width (mm)	Height (mm)
TPS726126DCQR	SOT-223	DCQ	6	2500	406.0	348.0	63.0
TPS72615DCQR	SOT-223	DCQ	6	2500	358.0	335.0	35.0
TPS72615KTTR	DDPAK/TO-263	KTT	5	500	367.0	367.0	45.0
TPS72615KTTT	DDPAK/TO-263	KTT	5	50	367.0	367.0	45.0
TPS72616DCQR	SOT-223	DCQ	6	2500	406.0	348.0	63.0
TPS72616KTTR	DDPAK/TO-263	KTT	5	500	367.0	367.0	45.0
TPS72616KTTT	DDPAK/TO-263	KTT	5	50	367.0	367.0	45.0
TPS72618DCQR	SOT-223	DCQ	6	2500	358.0	335.0	35.0
TPS72618KTTR	DDPAK/TO-263	KTT	5	500	367.0	367.0	45.0
TPS72618KTTT	DDPAK/TO-263	KTT	5	50	367.0	367.0	45.0
TPS72625DCQR	SOT-223	DCQ	6	2500	406.0	348.0	63.0
TPS72625KTTT	DDPAK/TO-263	KTT	5	50	367.0	367.0	45.0

DCQ (R-PDSO-G6)

PLASTIC SMALL-OUTLINE



4202109/D 06/09

- NOTES:
- A. All linear dimensions are in inches (millimeters).
 - B. This drawing is subject to change without notice.
 - C. Controlling dimension in inches.
 - $\triangle D$ Body length and width dimensions are determined at the outermost extremes of the plastic body exclusive of mold flash, tie bar burrs, gate burrs, and interlead flash, but including any mismatch between the top and the bottom of the plastic body.
 - $\triangle E$ Lead width dimension does not include dambar protrusion.
 - $\triangle F$ Lead width and thickness dimensions apply to solder plated leads.
 - G. Interlead flash allow 0.008 inch max.
 - H. Gate burr/protrusion max. 0.006 inch.
 - I. Datums A and B are to be determined at Datum H.

DCQ (R-PDSO-G6)

PLASTIC SMALL OUTLINE



- NOTES:
- All linear dimensions are in millimeters.
 - This drawing is subject to change without notice.
 - Publication IPC-SM-782 is recommended for alternate designs.
 - Laser cutting apertures with trapezoidal walls and also rounding corners will offer better paste release. Customers should contact their board assembly site for stencil design recommendations.
 - Customers should contact their board fabrication site for solder mask tolerances between and around signal pads.
 - Please refer to the product data sheet for specific via and thermal dissipation requirements.

KTT (R-PSFM-G5)

PLASTIC FLANGE-MOUNT PACKAGE



- NOTES:
- A. All linear dimensions are in millimeters.
 - B. This drawing is subject to change without notice.
 - C. Body dimensions do not include mold flash or protrusion. Mold flash or protrusion not to exceed 0.005 (0,13) per side.
- △ Falls within JEDEC TO-263 variation BA, except minimum lead thickness, maximum seating height, and minimum body length.

KTT (R-PSFM-G5)

PLASTIC FLANGE-MOUNT PACKAGE

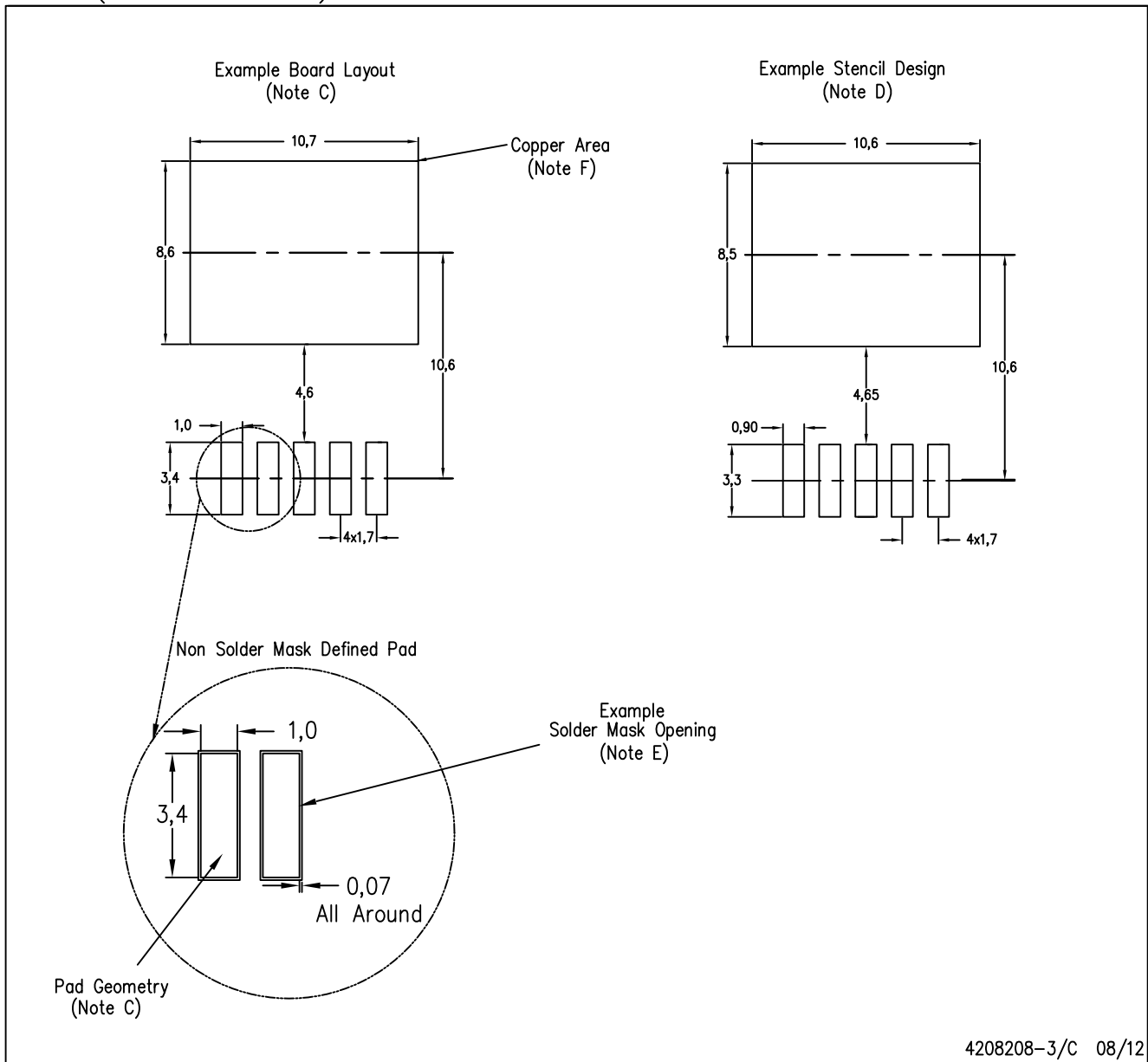

4208208-3/C 08/12

- NOTES:
- All linear dimensions are in millimeters.
 - This drawing is subject to change without notice.
 - Publication IPC-SM-782 is recommended for alternate designs.
 - Laser cutting apertures with trapezoidal walls and also rounding corners will offer better paste release. Customers should contact their board assembly site for stencil design recommendations. Refer to IPC-7525.
 - Customers should contact their board fabrication site for solder mask tolerances between and around signal pads.
 - This package is designed to be soldered to a thermal pad on the board. Refer to the Product Datasheet for specific thermal information, via requirements, and recommended thermal pad size. For thermal pad sizes larger than shown a solder mask defined pad is recommended in order to maintain the solderable pad geometry while increasing copper area.

IMPORTANT NOTICE

Texas Instruments Incorporated and its subsidiaries (TI) reserve the right to make corrections, enhancements, improvements and other changes to its semiconductor products and services per JESD46, latest issue, and to discontinue any product or service per JESD48, latest issue. Buyers should obtain the latest relevant information before placing orders and should verify that such information is current and complete. All semiconductor products (also referred to herein as "components") are sold subject to TI's terms and conditions of sale supplied at the time of order acknowledgment.

TI warrants performance of its components to the specifications applicable at the time of sale, in accordance with the warranty in TI's terms and conditions of sale of semiconductor products. Testing and other quality control techniques are used to the extent TI deems necessary to support this warranty. Except where mandated by applicable law, testing of all parameters of each component is not necessarily performed.

TI assumes no liability for applications assistance or the design of Buyers' products. Buyers are responsible for their products and applications using TI components. To minimize the risks associated with Buyers' products and applications, Buyers should provide adequate design and operating safeguards.

TI does not warrant or represent that any license, either express or implied, is granted under any patent right, copyright, mask work right, or other intellectual property right relating to any combination, machine, or process in which TI components or services are used. Information published by TI regarding third-party products or services does not constitute a license to use such products or services or a warranty or endorsement thereof. Use of such information may require a license from a third party under the patents or other intellectual property of the third party, or a license from TI under the patents or other intellectual property of TI.

Reproduction of significant portions of TI information in TI data books or data sheets is permissible only if reproduction is without alteration and is accompanied by all associated warranties, conditions, limitations, and notices. TI is not responsible or liable for such altered documentation. Information of third parties may be subject to additional restrictions.

Resale of TI components or services with statements different from or beyond the parameters stated by TI for that component or service voids all express and any implied warranties for the associated TI component or service and is an unfair and deceptive business practice. TI is not responsible or liable for any such statements.

Buyer acknowledges and agrees that it is solely responsible for compliance with all legal, regulatory and safety-related requirements concerning its products, and any use of TI components in its applications, notwithstanding any applications-related information or support that may be provided by TI. Buyer represents and agrees that it has all the necessary expertise to create and implement safeguards which anticipate dangerous consequences of failures, monitor failures and their consequences, lessen the likelihood of failures that might cause harm and take appropriate remedial actions. Buyer will fully indemnify TI and its representatives against any damages arising out of the use of any TI components in safety-critical applications.

In some cases, TI components may be promoted specifically to facilitate safety-related applications. With such components, TI's goal is to help enable customers to design and create their own end-product solutions that meet applicable functional safety standards and requirements. Nonetheless, such components are subject to these terms.

No TI components are authorized for use in FDA Class III (or similar life-critical medical equipment) unless authorized officers of the parties have executed a special agreement specifically governing such use.

Only those TI components which TI has specifically designated as military grade or "enhanced plastic" are designed and intended for use in military/aerospace applications or environments. Buyer acknowledges and agrees that any military or aerospace use of TI components which have **not** been so designated is solely at the Buyer's risk, and that Buyer is solely responsible for compliance with all legal and regulatory requirements in connection with such use.

TI has specifically designated certain components as meeting ISO/TS16949 requirements, mainly for automotive use. In any case of use of non-designated products, TI will not be responsible for any failure to meet ISO/TS16949.

Products

Audio	www.ti.com/audio
Amplifiers	amplifier.ti.com
Data Converters	dataconverter.ti.com
DLP® Products	www.dlp.com
DSP	dsp.ti.com
Clocks and Timers	www.ti.com/clocks
Interface	interface.ti.com
Logic	logic.ti.com
Power Mgmt	power.ti.com
Microcontrollers	microcontroller.ti.com
RFID	www.ti-rfid.com
OMAP Applications Processors	www.ti.com/omap
Wireless Connectivity	www.ti.com/wirelessconnectivity

Applications

Automotive and Transportation	www.ti.com/automotive
Communications and Telecom	www.ti.com/communications
Computers and Peripherals	www.ti.com/computers
Consumer Electronics	www.ti.com/consumer-apps
Energy and Lighting	www.ti.com/energy
Industrial	www.ti.com/industrial
Medical	www.ti.com/medical
Security	www.ti.com/security
Space, Avionics and Defense	www.ti.com/space-avionics-defense
Video and Imaging	www.ti.com/video

TI E2E Community

e2e.ti.com