

## 200mA Low-Noise, High-PSRR Negative Output Low-Dropout Linear Regulators

### FEATURES

- **Ultralow Noise:** 60 $\mu$ V<sub>RMS</sub> Typical
- **High PSRR:** 65dB Typical at 1kHz
- **Low Dropout Voltage:** 280mV Typical at 200mA, 2.5V
- **Available in –2.5V and Adjustable (–1.2V to –10V) Versions**
- **Stable With a 2.2 $\mu$ F Ceramic Output Capacitor**
- **Less Than 2 $\mu$ A Typical Quiescent Current in Shutdown Mode**
- **2% Overall Accuracy (Line, Load, Temperature)**
- **Thermal and Over-Current Protection**
- **SOT23-5 (DBV) Package**
- **Operating Junction Temperature Range:** –40°C to +125°C

### APPLICATIONS

- Optical Drives
- Optical Networking
- Noise Sensitive Circuitry
- GaAs FET Gate Bias
- Video Amplifiers

### DESCRIPTION

The TPS723xx family of low-dropout (LDO) negative voltage regulators offers an ideal combination of features to support low noise applications. These devices are capable of operating with input voltages from –10V to –2.7V, and support outputs from –10V to –1.2V. These regulators are stable with small, low-cost ceramic capacitors, and include enable (EN) and noise reduction (NR) functions. Thermal short-circuit and over-current protections are provided by internal detection and shutdown logic. High PSRR (65dB at 1kHz) and low noise (60 $\mu$ V<sub>RMS</sub>) make the TPS723xx ideal for low-noise applications.

The TPS723xx uses a precision voltage reference to achieve 2% overall accuracy over load, line, and temperature variations. Available in a small SOT23-5 package, the TPS723xx family is fully specified over a temperature range of –40°C to +125°C.

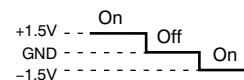
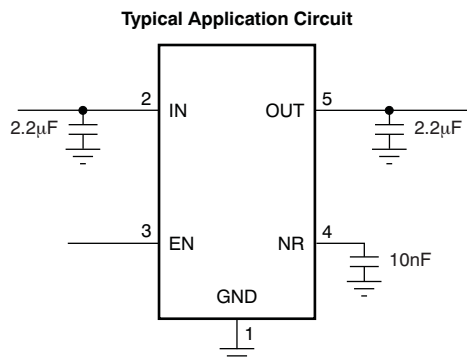

**DBV Package (Top View)  
TPS72301**

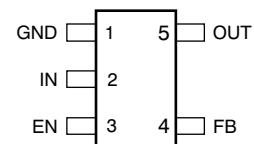

Adjustable Option

**DBV Package (Top View)  
TPS723xx**

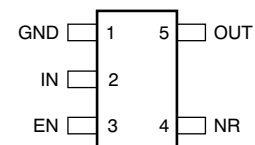

Fixed Option



Please be aware that an important notice concerning availability, standard warranty, and use in critical applications of Texas Instruments semiconductor products and disclaimers thereto appears at the end of this data sheet.

All trademarks are the property of their respective owners.



This integrated circuit can be damaged by ESD. Texas Instruments recommends that all integrated circuits be handled with appropriate precautions. Failure to observe proper handling and installation procedures can cause damage.

ESD damage can range from subtle performance degradation to complete device failure. Precision integrated circuits may be more susceptible to damage because very small parametric changes could cause the device not to meet its published specifications.

### ORDERING INFORMATION<sup>(1)</sup>

PRODUCT	V <sub>OUT</sub> <sup>(2)</sup>
TPS723xyyz	XX is nominal output voltage (for example, 25 = 2.5V, 01 = Adjustable.) YYY is package designator. Z is package quantity.

- (1) For the most current package and ordering information see the Package Option Addendum at the end of this document, or see the TI web site at [www.ti.com](http://www.ti.com).
- (2) Output voltages from –1.2V to –9V in 100mV increments are available. Minimum order quantities apply; contact factory for details and availability.

### ABSOLUTE MAXIMUM RATINGS<sup>(1)(2)</sup>

Over operating temperature range, unless otherwise noted.

	VALUE	UNITS
Input voltage range, V <sub>IN</sub>	–11 to +0.3	V
Noise reduction pin voltage range, V <sub>NR</sub>	–11 to +5.5	V
Enable voltage range, V <sub>EN</sub>	–V <sub>IN</sub> to +5.5	V
Output voltage range, V <sub>OUT</sub>	–11 to +0.3	V
Output current, I <sub>OUT</sub>	Internally limited	
Output short-circuit duration	Indefinite	
Continuous total power dissipation, P <sub>D</sub>	See <a href="#">Power Dissipation Ratings</a> table	
Junction temperature range, T <sub>J</sub>	–55 to +150	°C
Storage temperature range, T <sub>stg</sub>	–65 to +150	°C

- (1) Stresses beyond those listed under *absolute maximum ratings* may cause permanent damage to the device. These are stress ratings only, and functional operation of the device at these or any other conditions beyond those indicated under *recommended operating conditions* is not implied. Exposure to absolute-maximum-rated conditions for extended periods may affect device reliability.
- (2) All voltage values are with respect to network ground terminal.

### POWER DISSIPATION RATINGS

BOARD	PACKAGE	R <sub>θJC</sub>	R <sub>θJA</sub>	DERATING FACTOR ABOVE T <sub>A</sub> = +25°C	T <sub>A</sub> ≤ +25°C POWER RATING	T <sub>A</sub> = +70°C POWER RATING	T <sub>A</sub> = +85°C POWER RATING
Low-K <sup>(1)</sup>	DBV	64°C/W	255°C/W	3.9mW/°C	390mW	215mW	155mW
High-K <sup>(2)</sup>	DBV	64°C/W	180°C/W	5.6mW/°C	560mW	310mW	225mW

- (1) The JEDEC Low-K (1s) board design used to derive this data was a 3 inch × 3 inch, two-layer board with 2-ounce copper traces on top of the board.
- (2) The JEDEC High-K (2s2p) board design used to derive this data was a 3 inch × 3 inch, multilayer board with 1-ounce internal power and ground planes and 2-ounce copper traces on the top and bottom of the board.

## ELECTRICAL CHARACTERISTICS

Over operating junction temperature range,  $V_{IN} = V_{OUTnom} - 0.5V$ ,  $I_{OUT} = 1mA$ ,  $V_{EN} = 1.5V$ ,  $C_{OUT} = 2.2\mu F$ , and  $C_{NR} = 0.01\mu F$ , unless otherwise noted. Typical values are at  $T_J = +25^\circ C$ .

PARAMETER		TEST CONDITIONS	TPS723xx			UNITS	
			MIN	TYP	MAX		
$V_{IN}$	Input voltage range <sup>(1)</sup>		-10		-2.7	V	
$V_{FB}$	Feedback reference voltage	TPS72301 $T_J = +25^\circ C$	-1.210	-1.186	-1.162	V	
$V_{OUT}$	Output voltage range	TPS72301	$-10 + V_{DO}$		$V_{FB}$	V	
	Accuracy	Nominal	$T_J = +25^\circ C$	-1	1	%	
		TPS72325 vs $V_{IN}/I_{OUT}/T$	$-10V \leq V_{IN} \leq V_{OUT} - 0.5V$ , $10\mu A \leq I_{OUT} \leq 200mA$	-2	$\pm 1$	2	%
TPS72301 vs $V_{IN}/I_{OUT}/T$	-3	$\pm 1$		3	%		
$V_{OUT}\%/V_{IN}$	Line regulation		$-10V \leq V_{IN} \leq V_{OUT(nom)} - 0.5V$	0.04		%/V	
$V_{OUT}\%/I_{OUT}$	Load regulation		$0mA \leq I_{OUT} \leq 200mA$	0.002		%/mA	
$V_{DO}$	Dropout voltage at $V_{OUT} = 0.96 \times V_{OUTnom}$	TPS72325	$I_{OUT} = 200mA$	280	500	mV	
$I_{CL}$	Current limit		$V_{OUT} = 0.85 \times V_{OUT(nom)}$	300	550	800	mA
$I_{GND}$	Ground pin current		$I_{OUT} = 0mA (I_Q)$ , $-10V \leq V_{IN} \leq V_{OUT} - 0.5V$	130	200	$\mu A$	
			$I_{OUT} = 200mA$ , $-10V \leq V_{IN} \leq V_{OUT} - 0.5V$	350	500		
$I_{SHDN}$	Shutdown ground pin current		$-0.4V \leq V_{EN} \leq 0.4V$ , $-10V \leq V_{IN} \leq V_{OUT} - 0.5V$	0.1	2.0	$\mu A$	
$I_{FB}$	Feedback pin current		$-10V \leq V_{IN} \leq V_{OUT} - 0.5V$	0.05	1.0	$\mu A$	
PSRR	Power-supply rejection ratio	TPS72325	$I_{OUT} = 200mA, 1kHz$ , $C_{IN} = C_{OUT} = 10\mu F$	65		dB	
			$I_{OUT} = 200mA, 10kHz$ , $C_{IN} = C_{OUT} = 10\mu F$	48			
$V_n$	Output noise voltage	TPS72325	$C_{OUT} = 10\mu F, 10Hz$ to $100kHz$ , $I_{OUT} = 200mA$	60		$\mu V_{RMS}$	
$t_{STR}$	Startup time		$V_{OUT} = -2.5V, C_{OUT} = 1\mu F$ , $R_L = 25\Omega$	1		ms	
$V_{EN(HI)}$	Enable threshold positive		1.5			V	
$V_{EN(LO)}$	Enable threshold negative				-1.5	V	
$V_{DIS(HI)}$	Disable threshold positive				0.4	V	
$V_{DIS(LO)}$	Disable threshold negative		-0.4			V	
$I_{EN}$	Enable pin current		$-10V \leq V_{IN} \leq V_{OUT} - 0.5V$ , $-10V \leq V_{EN} \leq \pm 3.5V$	0.1	2.0	$\mu A$	
$T_{SD}$	Thermal shutdown temperature		Shutdown, temperature increasing	+165		$^\circ C$	
			Reset, temperature decreasing	+145			
$T_J$	Operating junction temperature			-40	+125	$^\circ C$	

(1) Maximum  $V_{IN} = (V_{OUT} - V_{DO})$  or  $-2.7V$ , whichever is more negative.

FUNCTIONAL BLOCK DIAGRAM

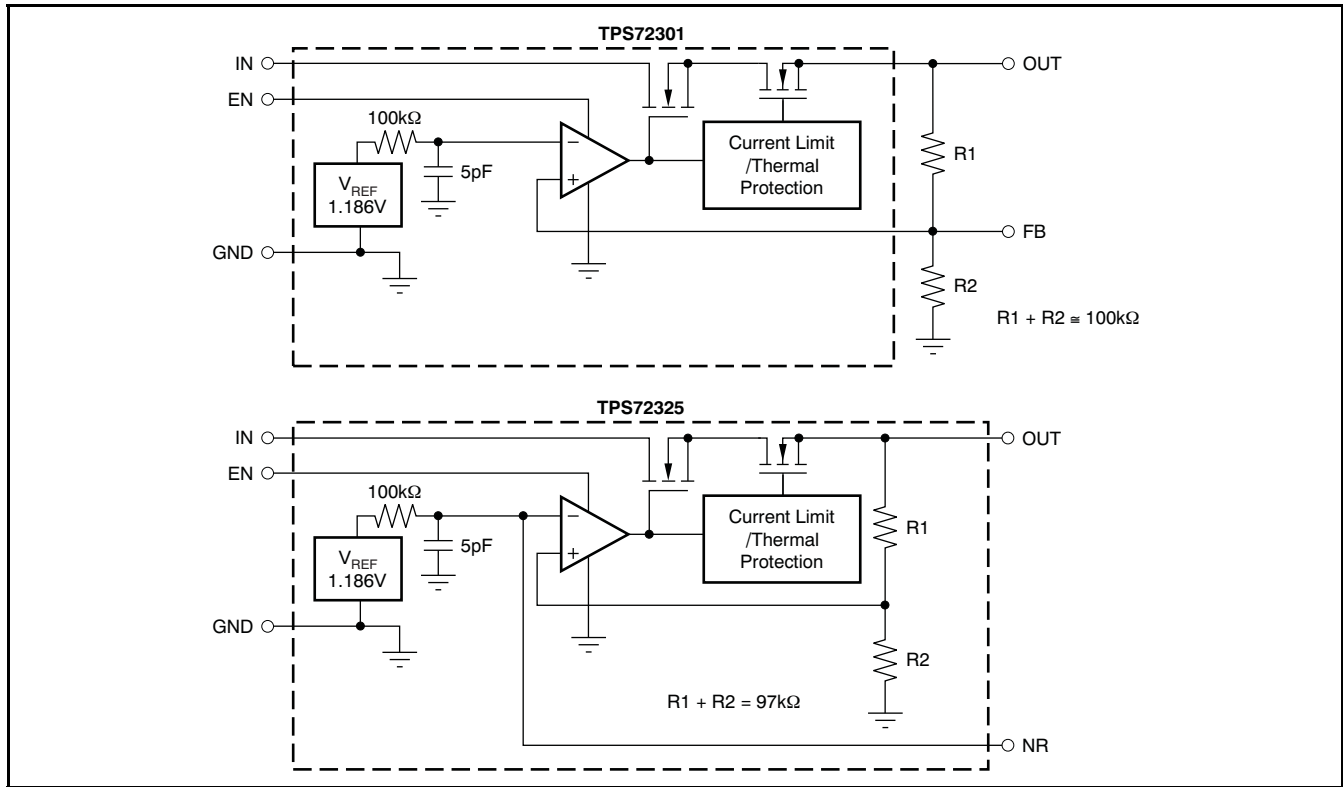

TERMINAL FUNCTIONS

TERMINAL		DESCRIPTION
NAME	NO.	
GND	1	Ground
IN	2	Input supply
EN	3	Bipolar enable pin. Driving this pin above the positive enable threshold or below the negative enable threshold turns on the regulator. Driving this pin below the positive disable threshold and above the negative disable threshold puts the regulator into shutdown mode.
NR	4	Fixed voltage versions only. Connecting an external capacitor between this pin and ground, bypasses noise generated by the internal bandgap. This configuration allows output noise to be reduced to very low levels.
FB	4	Adjustable voltage version only. This pin is the input to the control loop error amplifier. It is used to set the output voltage of the device.
OUT	5	Regulated output voltage. A small 2.2μF ceramic capacitor is needed from this pin to GND to ensure stability.

**TYPICAL CHARACTERISTICS**

TPS72325 at  $V_{IN} = V_{OUTnom} - 0.5V$ ,  $I_{OUT} = 1mA$ ,  $V_{EN} = 1.5V$ ,  $C_{OUT} = 2.2\mu F$ , and  $C_{NR} = 0.01\mu F$ , unless otherwise noted.

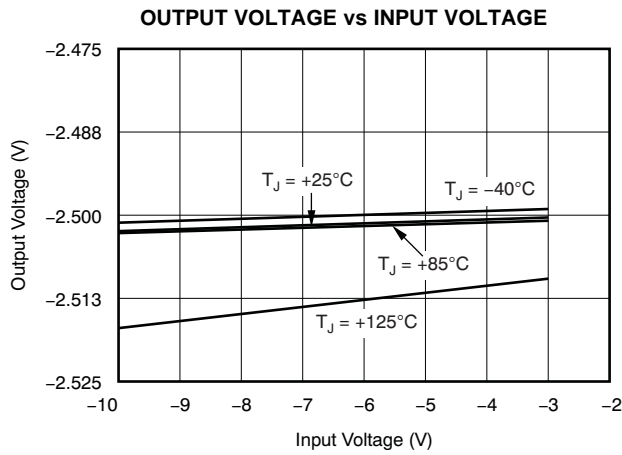

Figure 1.

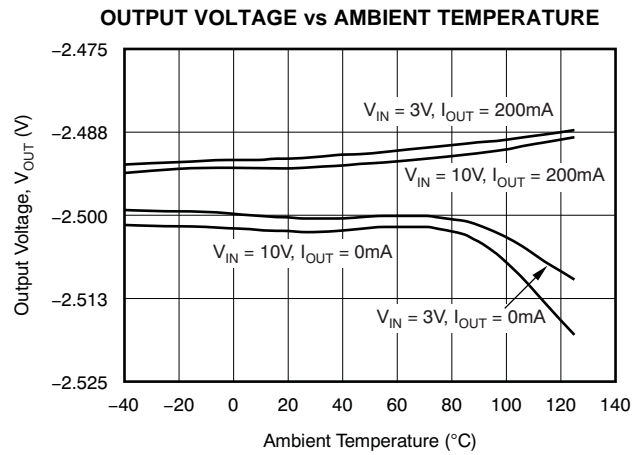

Figure 2.

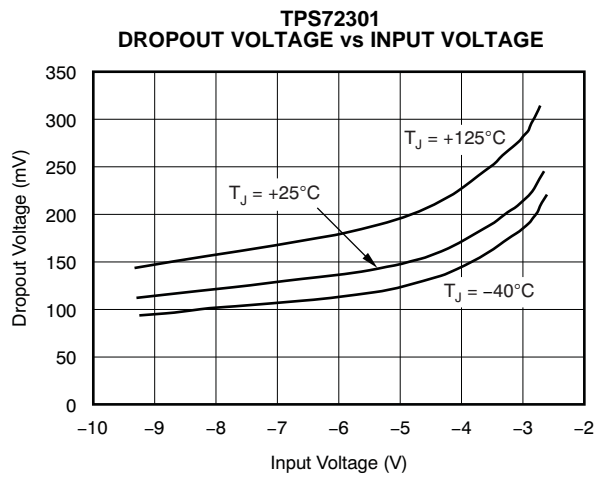

Figure 3.

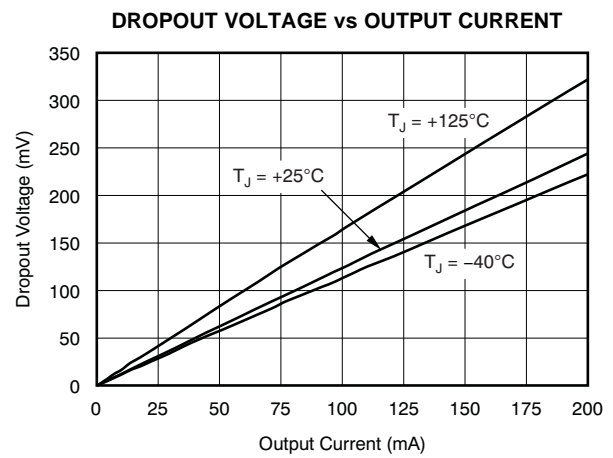

Figure 4.

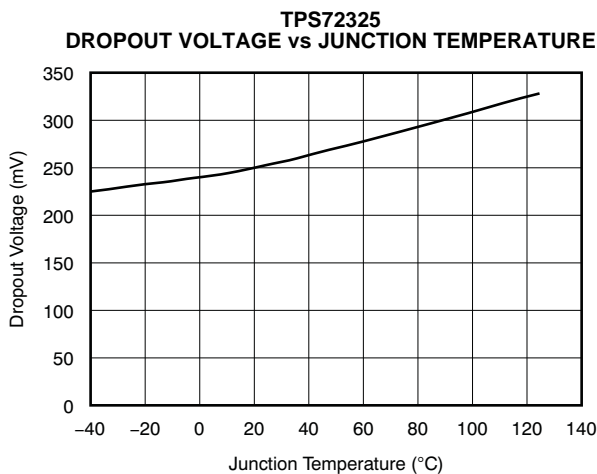

Figure 5.

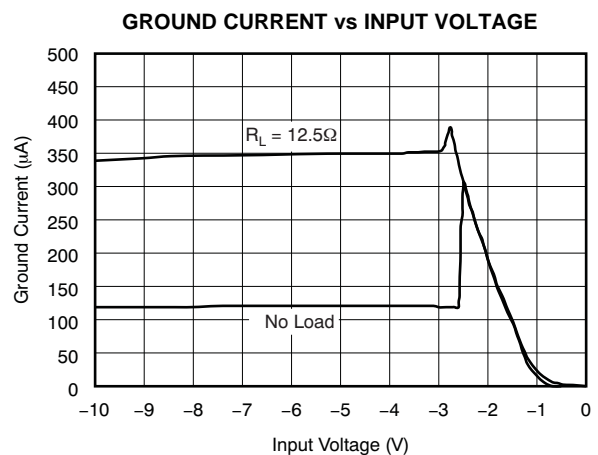

Figure 6.

**TYPICAL CHARACTERISTICS (continued)**

TPS72325 at  $V_{IN} = V_{OUTnom} - 0.5V$ ,  $I_{OUT} = 1mA$ ,  $V_{EN} = 1.5V$ ,  $C_{OUT} = 2.2\mu F$ , and  $C_{NR} = 0.01\mu F$ , unless otherwise noted.

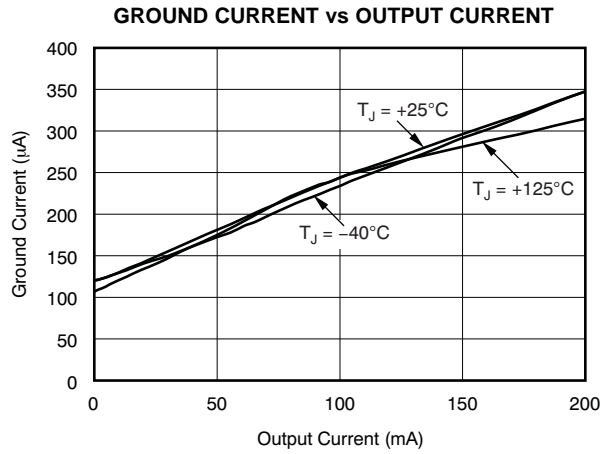

Figure 7.

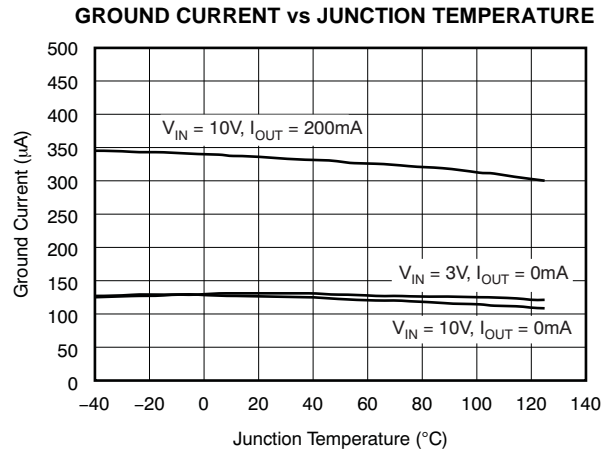

Figure 8.

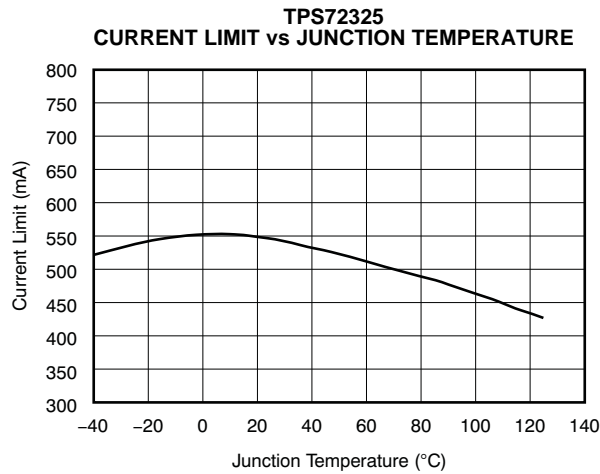

Figure 9.

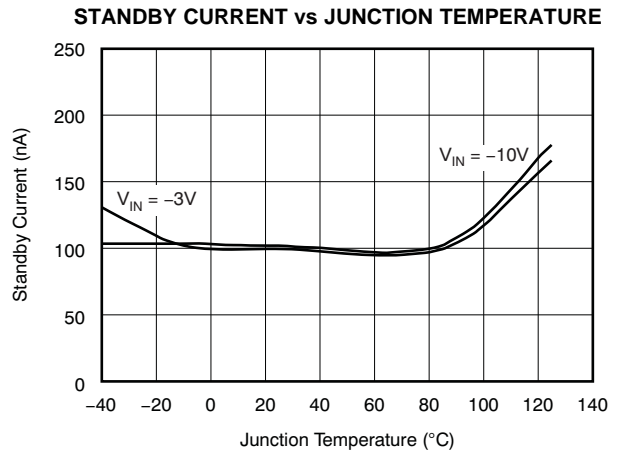

Figure 10.

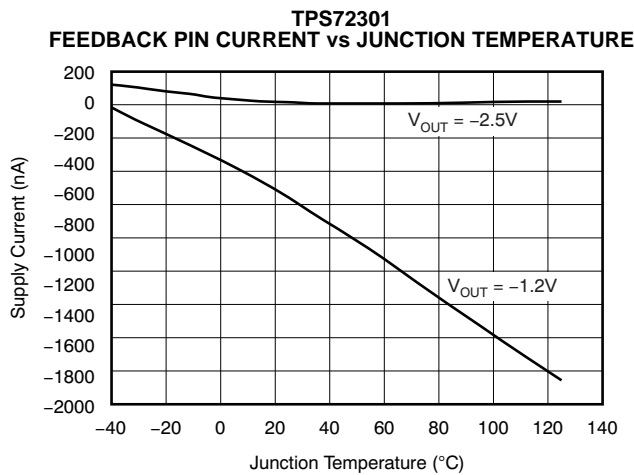

Figure 11.

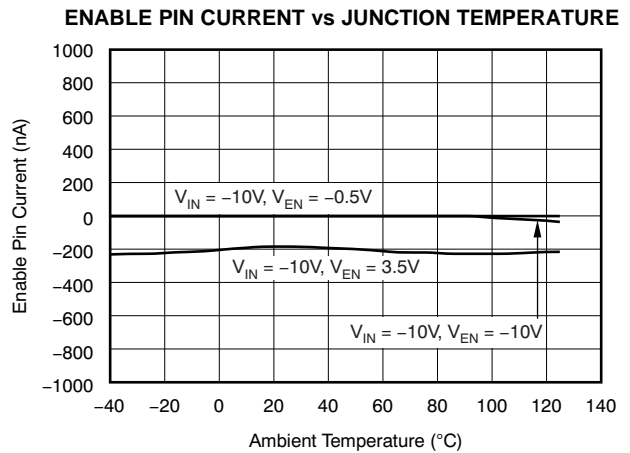
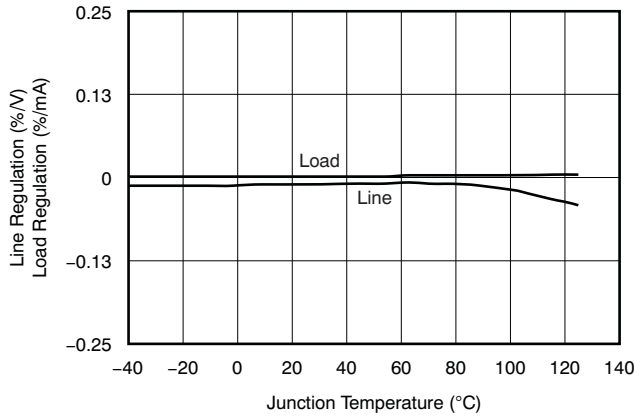

Figure 12.

**TYPICAL CHARACTERISTICS (continued)**

TPS72325 at  $V_{IN} = V_{OUTnom} - 0.5V$ ,  $I_{OUT} = 1mA$ ,  $V_{EN} = 1.5V$ ,  $C_{OUT} = 2.2\mu F$ , and  $C_{NR} = 0.01\mu F$ , unless otherwise noted.

**LINE AND LOAD REGULATION vs JUNCTION TEMPERATURE**



**Figure 13.**

**TPS72301 MINIMUM REQUIRED INPUT VOLTAGE vs OUTPUT VOLTAGE**

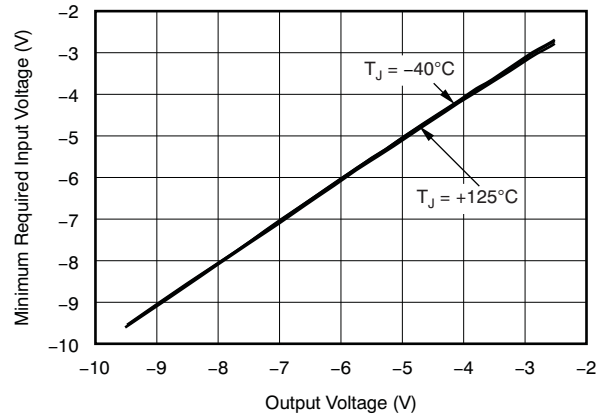

**Figure 14.**

**TPS72325 LINE TRANSIENT RESPONSE**

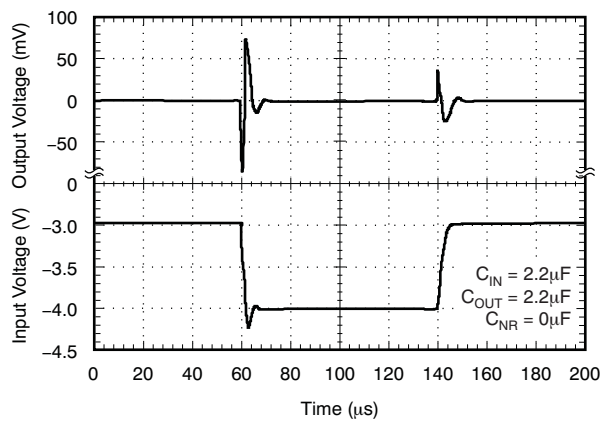

**Figure 15.**

**TPS72325 LOAD TRANSIENT RESPONSE**

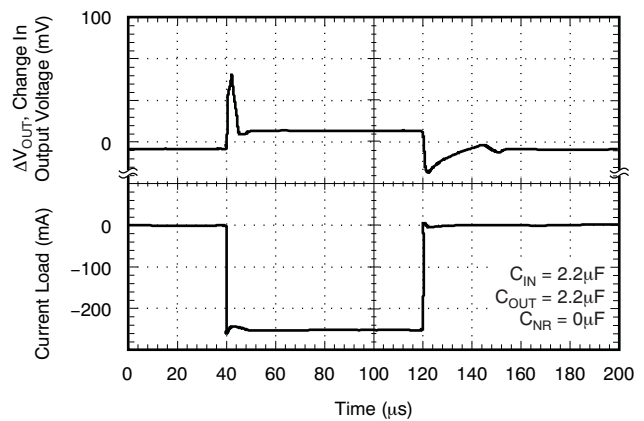

**Figure 16.**

**TPS72325 LOAD TRANSIENT RESPONSE**

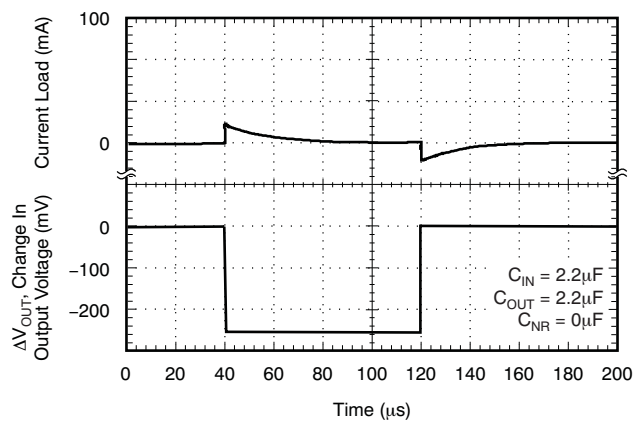

**Figure 17.**

**TPS72325 START-UP RESPONSE**

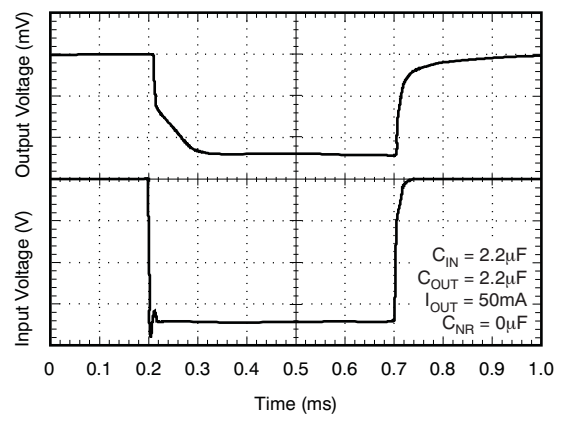

**Figure 18.**

**TYPICAL CHARACTERISTICS (continued)**

TPS72325 at  $V_{IN} = V_{OUTnom} - 0.5V$ ,  $I_{OUT} = 1mA$ ,  $V_{EN} = 1.5V$ ,  $C_{OUT} = 2.2\mu F$ , and  $C_{NR} = 0.01\mu F$ , unless otherwise noted.

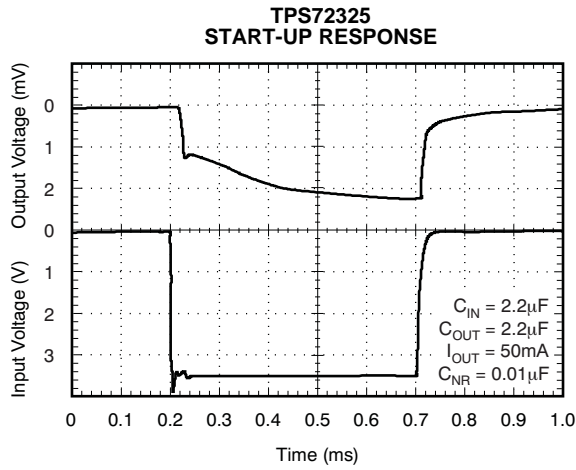

Figure 19.

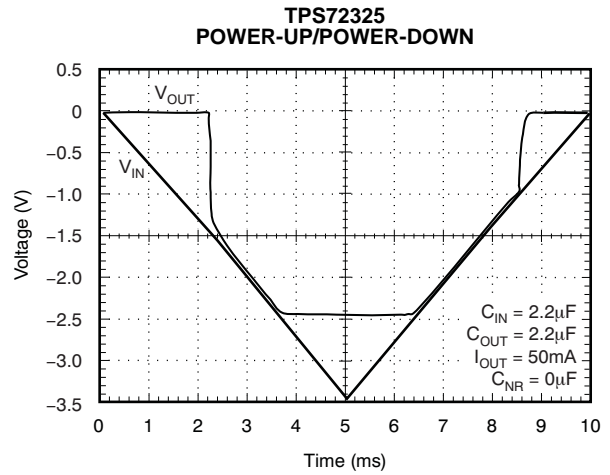

Figure 20.

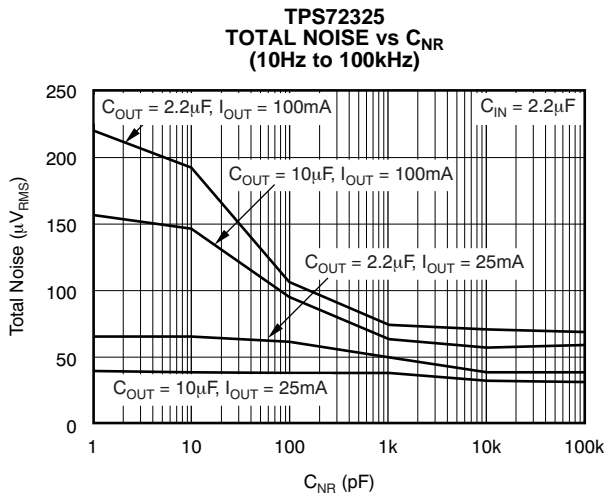

Figure 21.

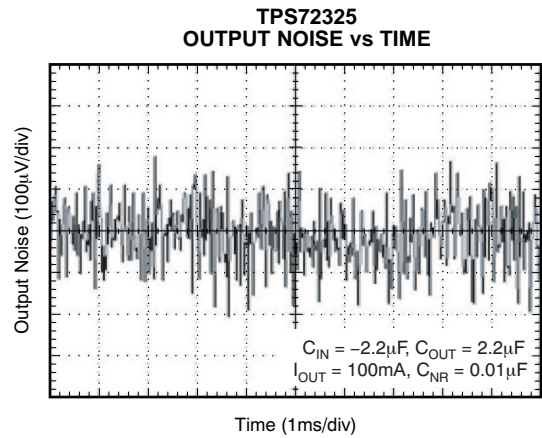

Figure 22.

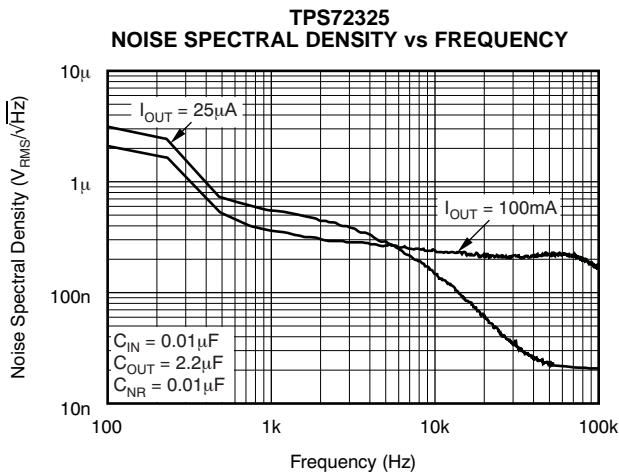

Figure 23.

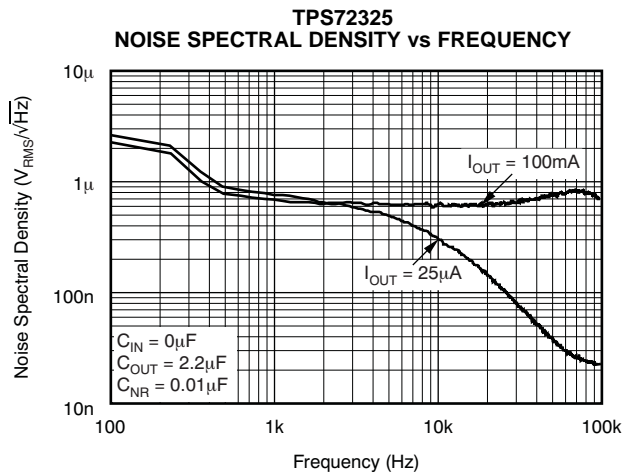
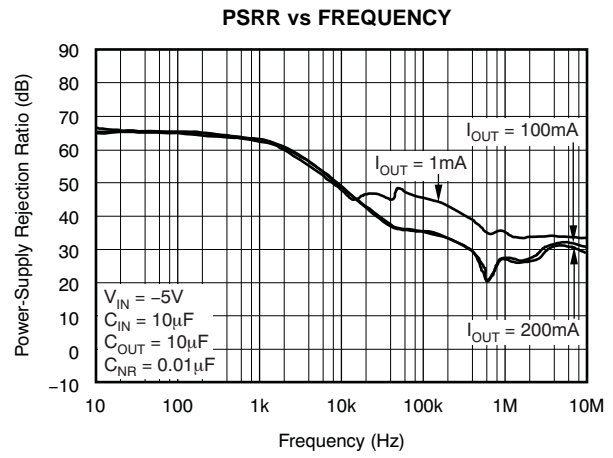
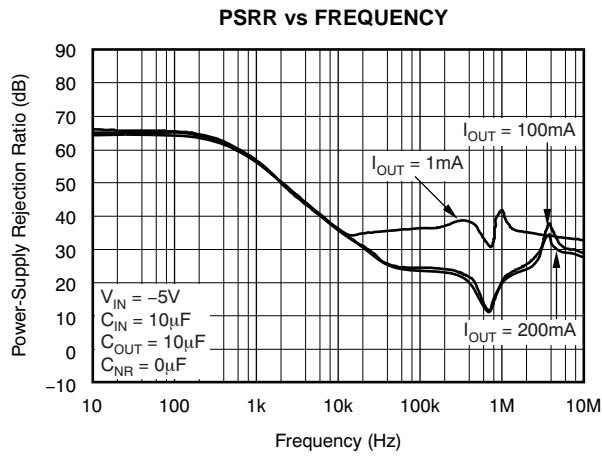

Figure 24.

**TYPICAL CHARACTERISTICS (continued)**

TPS72325 at  $V_{IN} = V_{OUTnom} - 0.5V$ ,  $I_{OUT} = 1mA$ ,  $V_{EN} = 1.5V$ ,  $C_{OUT} = 2.2\mu F$ , and  $C_{NR} = 0.01\mu F$ , unless otherwise noted.



## APPLICATION INFORMATION

### DEVICE OPERATION

The TPS723xx is a low-dropout negative linear voltage regulator with a rated current of 200mA. It is offered in trimmed output voltages between  $-1.5\text{V}$  and  $-5.2\text{V}$  and as an adjustable regulator from  $-1.2\text{V}$  to  $-10\text{V}$ . It features very low noise and high power-supply rejection ratio (PSRR), making it ideal for high-sensitivity analog and RF applications. A shutdown mode is available, reducing ground current to  $2\mu\text{A}$  maximum over temperature and process. The TPS723xx is offered in a small SOT23 package and is specified over a  $-40^\circ\text{C}$  to  $+125^\circ\text{C}$  junction temperature range.

### ENABLE

The enable pin is active above  $+1.5\text{V}$  and below  $-1.5\text{V}$ , allowing it to be controlled by a standard TTL signal or by connection to  $V_I$  if not used. When driven to GND most internal circuitry is turned off, putting the TPS723xx into shutdown mode, drawing  $2\mu\text{A}$  maximum ground current.

### ADJUSTABLE VOLTAGE APPLICATIONS

The TPS72301 allows designers to specify any output voltage from  $-10\text{V}$  to  $-1.2\text{V}$ . As shown in the application circuit in [Figure 27](#), an external resistor divider is used to scale the output voltage ( $V_{\text{OUT}}$ ) to the reference voltage. For best accuracy, use precision resistors for R1 and R2. Use the equations in [Figure 27](#) to determine the values for the resistor divider.

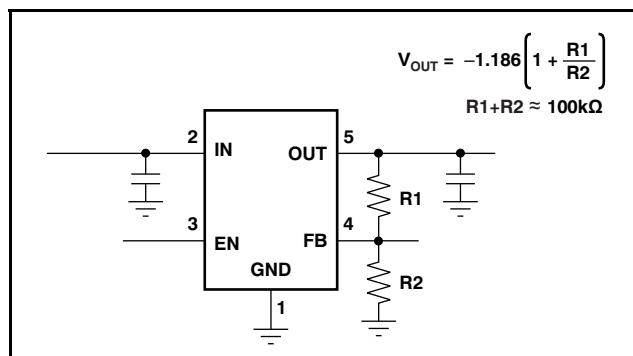

**Figure 27. TPS72301 Adjustable LDO Regulator Programming**

### CAPACITOR SELECTION FOR STABILITY

Appropriate input and output capacitors should be used for the intended application. The TPS723xx only requires a  $2.2\mu\text{F}$  ceramic output capacitor to be

used for stable operation. Both the capacitor value and ESR affect stability, output noise, PSRR, and transient response. For typical applications, a  $2.2\mu\text{F}$  ceramic output capacitor located close to the regulator is sufficient.

### OUTPUT NOISE

Without external bypassing, output noise of the TPS723xx from  $10\text{Hz}$  to  $100\text{kHz}$  is  $200\mu\text{V}_{\text{RMS}}$  typical. The dominant contributor to output noise is the internal bandgap reference. Adding an external  $0.01\mu\text{F}$  capacitor to ground reduces noise to  $60\mu\text{V}_{\text{RMS}}$ . Best noise performance is achieved using appropriate low ESR capacitors for bypassing noise at the NR and OUT pins. See [Figure 21](#) in the [Typical Characteristics](#) section.

### POWER-SUPPLY REJECTION

The TPS723xx offers a very high PSRR for applications with noisy input sources or highly sensitive output supply lines. For best PSRR, use high-quality input and output capacitors.

### CURRENT LIMIT

The TPS723xx has internal circuitry that monitors and limits output current to protect the regulator from damage under all load conditions. When output current reaches the output current limit ( $550\text{mA}$  typical), protection circuitry turns on, reducing output voltage to ensure that current does not increase. See [Figure 9](#) in the [Typical Characteristics](#) section.

Do not drive the output more than  $0.3\text{V}$  above the input. Doing so will bias the body diode in the pass FET, allowing current to flow from the output to the input. This current is not limited by the device. If this condition is expected, care should be taken to externally limit the reverse current.

### THERMAL PROTECTION

As protection from damage due to excessive junction temperatures, the TPS723xx has internal protection circuitry. When junction temperature reaches approximately  $+165^\circ\text{C}$ , the output device is turned off. After the device has cooled by about  $20^\circ\text{C}$ , the output device is enabled, allowing normal operation. For reliable operation, design is for worst-case junction temperature of  $\leq +125^\circ\text{C}$  taking into account worst-case ambient temperature and load conditions.

**PACKAGING INFORMATION**

Orderable Device	Status <sup>(1)</sup>	Package Type	Package Drawing	Pins	Package Qty	Eco Plan <sup>(2)</sup>	Lead/Ball Finish	MSL Peak Temp <sup>(3)</sup>
TPS72301DBVR	ACTIVE	SOT-23	DBV	5	3000	Green (RoHS & no Sb/Br)	CU NIPDAU	Level-1-260C-UNLIM
TPS72301DBVRG4	ACTIVE	SOT-23	DBV	5	3000	Green (RoHS & no Sb/Br)	CU NIPDAU	Level-1-260C-UNLIM
TPS72301DBVT	ACTIVE	SOT-23	DBV	5	250	Green (RoHS & no Sb/Br)	CU NIPDAU	Level-1-260C-UNLIM
TPS72301DBVTG4	ACTIVE	SOT-23	DBV	5	250	Green (RoHS & no Sb/Br)	CU NIPDAU	Level-1-260C-UNLIM
TPS72325DBVR	ACTIVE	SOT-23	DBV	5	3000	Green (RoHS & no Sb/Br)	CU NIPDAU	Level-1-260C-UNLIM
TPS72325DBVRG4	ACTIVE	SOT-23	DBV	5	3000	Green (RoHS & no Sb/Br)	CU NIPDAU	Level-1-260C-UNLIM
TPS72325DBVT	ACTIVE	SOT-23	DBV	5	250	Green (RoHS & no Sb/Br)	CU NIPDAU	Level-1-260C-UNLIM
TPS72325DBVTG4	ACTIVE	SOT-23	DBV	5	250	Green (RoHS & no Sb/Br)	CU NIPDAU	Level-1-260C-UNLIM

<sup>(1)</sup> The marketing status values are defined as follows:

**ACTIVE:** Product device recommended for new designs.

**LIFEBUY:** TI has announced that the device will be discontinued, and a lifetime-buy period is in effect.

**NRND:** Not recommended for new designs. Device is in production to support existing customers, but TI does not recommend using this part in a new design.

**PREVIEW:** Device has been announced but is not in production. Samples may or may not be available.

**OBSOLETE:** TI has discontinued the production of the device.

<sup>(2)</sup> Eco Plan - The planned eco-friendly classification: Pb-Free (RoHS), Pb-Free (RoHS Exempt), or Green (RoHS & no Sb/Br) - please check <http://www.ti.com/productcontent> for the latest availability information and additional product content details.

**TBD:** The Pb-Free/Green conversion plan has not been defined.

**Pb-Free (RoHS):** TI's terms "Lead-Free" or "Pb-Free" mean semiconductor products that are compatible with the current RoHS requirements for all 6 substances, including the requirement that lead not exceed 0.1% by weight in homogeneous materials. Where designed to be soldered at high temperatures, TI Pb-Free products are suitable for use in specified lead-free processes.

**Pb-Free (RoHS Exempt):** This component has a RoHS exemption for either 1) lead-based flip-chip solder bumps used between the die and package, or 2) lead-based die adhesive used between the die and leadframe. The component is otherwise considered Pb-Free (RoHS compatible) as defined above.

**Green (RoHS & no Sb/Br):** TI defines "Green" to mean Pb-Free (RoHS compatible), and free of Bromine (Br) and Antimony (Sb) based flame retardants (Br or Sb do not exceed 0.1% by weight in homogeneous material)

<sup>(3)</sup> MSL, Peak Temp. -- The Moisture Sensitivity Level rating according to the JEDEC industry standard classifications, and peak solder temperature.

**Important Information and Disclaimer:**The information provided on this page represents TI's knowledge and belief as of the date that it is provided. TI bases its knowledge and belief on information provided by third parties, and makes no representation or warranty as to the accuracy of such information. Efforts are underway to better integrate information from third parties. TI has taken and continues to take reasonable steps to provide representative and accurate information but may not have conducted destructive testing or chemical analysis on incoming materials and chemicals. TI and TI suppliers consider certain information to be proprietary, and thus CAS numbers and other limited information may not be available for release.

In no event shall TI's liability arising out of such information exceed the total purchase price of the TI part(s) at issue in this document sold by TI to Customer on an annual basis.

**TAPE AND REEL INFORMATION**



**QUADRANT ASSIGNMENTS FOR PIN 1 ORIENTATION IN TAPE**



\*All dimensions are nominal

Device	Package Type	Package Drawing	Pins	SPQ	Reel Diameter (mm)	Reel Width W1 (mm)	A0 (mm)	B0 (mm)	K0 (mm)	P1 (mm)	W (mm)	Pin1 Quadrant
TPS72301DBVR	SOT-23	DBV	5	3000	179.0	8.4	3.2	3.2	1.4	4.0	8.0	Q3
TPS72301DBVT	SOT-23	DBV	5	250	179.0	8.4	3.2	3.2	1.4	4.0	8.0	Q3
TPS72325DBVR	SOT-23	DBV	5	3000	179.0	8.4	3.2	3.2	1.4	4.0	8.0	Q3
TPS72325DBVT	SOT-23	DBV	5	250	179.0	8.4	3.2	3.2	1.4	4.0	8.0	Q3

**TAPE AND REEL BOX DIMENSIONS**



\*All dimensions are nominal

Device	Package Type	Package Drawing	Pins	SPQ	Length (mm)	Width (mm)	Height (mm)
TPS72301DBVR	SOT-23	DBV	5	3000	195.0	200.0	45.0
TPS72301DBVT	SOT-23	DBV	5	250	195.0	200.0	45.0
TPS72325DBVR	SOT-23	DBV	5	3000	195.0	200.0	45.0
TPS72325DBVT	SOT-23	DBV	5	250	195.0	200.0	45.0

DBV (R-PDSO-G5)

PLASTIC SMALL-OUTLINE PACKAGE

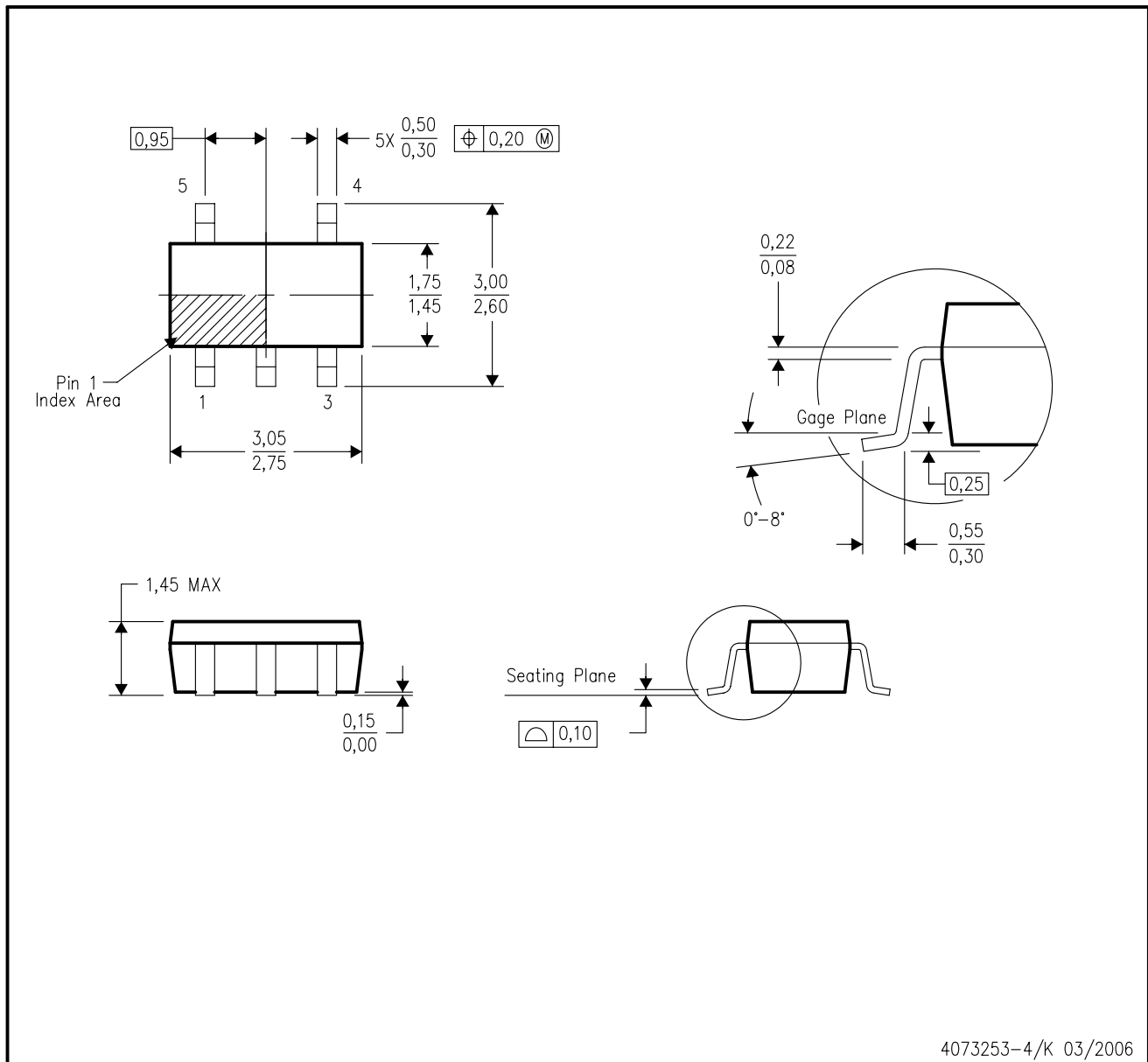

- NOTES:
- A. All linear dimensions are in millimeters.
  - B. This drawing is subject to change without notice.
  - C. Body dimensions do not include mold flash or protrusion. Mold flash and protrusion shall not exceed 0.15 per side.
  - D. Falls within JEDEC MO-178 Variation AA.

## IMPORTANT NOTICE

Texas Instruments Incorporated and its subsidiaries (TI) reserve the right to make corrections, modifications, enhancements, improvements, and other changes to its products and services at any time and to discontinue any product or service without notice. Customers should obtain the latest relevant information before placing orders and should verify that such information is current and complete. All products are sold subject to TI's terms and conditions of sale supplied at the time of order acknowledgment.

TI warrants performance of its hardware products to the specifications applicable at the time of sale in accordance with TI's standard warranty. Testing and other quality control techniques are used to the extent TI deems necessary to support this warranty. Except where mandated by government requirements, testing of all parameters of each product is not necessarily performed.

TI assumes no liability for applications assistance or customer product design. Customers are responsible for their products and applications using TI components. To minimize the risks associated with customer products and applications, customers should provide adequate design and operating safeguards.

TI does not warrant or represent that any license, either express or implied, is granted under any TI patent right, copyright, mask work right, or other TI intellectual property right relating to any combination, machine, or process in which TI products or services are used. Information published by TI regarding third-party products or services does not constitute a license from TI to use such products or services or a warranty or endorsement thereof. Use of such information may require a license from a third party under the patents or other intellectual property of the third party, or a license from TI under the patents or other intellectual property of TI.

Reproduction of TI information in TI data books or data sheets is permissible only if reproduction is without alteration and is accompanied by all associated warranties, conditions, limitations, and notices. Reproduction of this information with alteration is an unfair and deceptive business practice. TI is not responsible or liable for such altered documentation. Information of third parties may be subject to additional restrictions.

Resale of TI products or services with statements different from or beyond the parameters stated by TI for that product or service voids all express and any implied warranties for the associated TI product or service and is an unfair and deceptive business practice. TI is not responsible or liable for any such statements.

TI products are not authorized for use in safety-critical applications (such as life support) where a failure of the TI product would reasonably be expected to cause severe personal injury or death, unless officers of the parties have executed an agreement specifically governing such use. Buyers represent that they have all necessary expertise in the safety and regulatory ramifications of their applications, and acknowledge and agree that they are solely responsible for all legal, regulatory and safety-related requirements concerning their products and any use of TI products in such safety-critical applications, notwithstanding any applications-related information or support that may be provided by TI. Further, Buyers must fully indemnify TI and its representatives against any damages arising out of the use of TI products in such safety-critical applications.

TI products are neither designed nor intended for use in military/aerospace applications or environments unless the TI products are specifically designated by TI as military-grade or "enhanced plastic." Only products designated by TI as military-grade meet military specifications. Buyers acknowledge and agree that any such use of TI products which TI has not designated as military-grade is solely at the Buyer's risk, and that they are solely responsible for compliance with all legal and regulatory requirements in connection with such use.

TI products are neither designed nor intended for use in automotive applications or environments unless the specific TI products are designated by TI as compliant with ISO/TS 16949 requirements. Buyers acknowledge and agree that, if they use any non-designated products in automotive applications, TI will not be responsible for any failure to meet such requirements.

Following are URLs where you can obtain information on other Texas Instruments products and application solutions:

### Products

Amplifiers	<a href="http://amplifier.ti.com">amplifier.ti.com</a>
Data Converters	<a href="http://dataconverter.ti.com">dataconverter.ti.com</a>
DSP	<a href="http://dsp.ti.com">dsp.ti.com</a>
Clocks and Timers	<a href="http://www.ti.com/clocks">www.ti.com/clocks</a>
Interface	<a href="http://interface.ti.com">interface.ti.com</a>
Logic	<a href="http://logic.ti.com">logic.ti.com</a>
Power Mgmt	<a href="http://power.ti.com">power.ti.com</a>
Microcontrollers	<a href="http://microcontroller.ti.com">microcontroller.ti.com</a>
RFID	<a href="http://www.ti-rfid.com">www.ti-rfid.com</a>
RF/IF and ZigBee® Solutions	<a href="http://www.ti.com/lprf">www.ti.com/lprf</a>

### Applications

Audio	<a href="http://www.ti.com/audio">www.ti.com/audio</a>
Automotive	<a href="http://www.ti.com/automotive">www.ti.com/automotive</a>
Broadband	<a href="http://www.ti.com/broadband">www.ti.com/broadband</a>
Digital Control	<a href="http://www.ti.com/digitalcontrol">www.ti.com/digitalcontrol</a>
Medical	<a href="http://www.ti.com/medical">www.ti.com/medical</a>
Military	<a href="http://www.ti.com/military">www.ti.com/military</a>
Optical Networking	<a href="http://www.ti.com/opticalnetwork">www.ti.com/opticalnetwork</a>
Security	<a href="http://www.ti.com/security">www.ti.com/security</a>
Telephony	<a href="http://www.ti.com/telephony">www.ti.com/telephony</a>
Video & Imaging	<a href="http://www.ti.com/video">www.ti.com/video</a>
Wireless	<a href="http://www.ti.com/wireless">www.ti.com/wireless</a>

Mailing Address: Texas Instruments, Post Office Box 655303, Dallas, Texas 75265  
Copyright © 2008, Texas Instruments Incorporated