

Distributed by:

JAMECO[®]
ELECTRONICS

www.Jameco.com ♦ 1-800-831-4242

The content and copyrights of the attached
material are the property of its owner.

Jameco Part Number 1116531

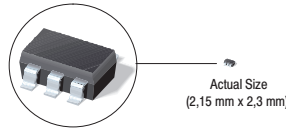

50 mA, 24 V, 3.2 μ A Supply Current Low-Dropout Linear Regulator in SC70 Package

FEATURES

- 24-V Maximum Input Voltage
- Low 3.2- μ A Quiescent Current at 50 mA
- Stable With Any Capacitor ($\geq 0.47 \mu\text{F}$)
- 50-mA Low-Dropout Regulator
- Available in 1.8 V, 1.9 V, 2.3 V, 2.5 V, 3.0 V, 3.3 V, 3.45 V, 5.0 V, and Adjustable (1.2 V to 15 V)
- Designed to Support **MSP430** Families:
 - 1.9 V version ensured to be higher than minimum V_{IN} of 1.8 V
 - 2.3 V version ensured to meet 2.2 V minimum V_{IN} for FLASH on MSP430F2xx
 - 3.45 V version ensured to be lower than maximum V_{IN} of 3.6 V
 - Wide variety of fixed output voltage options to match V_{IN} to the minimum required for desired MSP430 speed
- Minimum/Maximum Specified Current Limit
- 5-Pin SC70/SOT-323 (DCK) Package
- -40°C to $+125^{\circ}\text{C}$ Specified Junction Temperature Range
- For 80 mA Rated Current and Higher Power Package, see **TPS715Axx**

DESCRIPTION

The TPS715xx low-dropout (LDO) voltage regulators offer the benefits of high input voltage, low-dropout voltage, low-power operation, and miniaturized packaging. The devices, which operate over an input range of 2.5 V to 24 V, are stable with any capacitor ($\geq 0.47 \mu\text{F}$). The low dropout voltage and low quiescent current allow operations at extremely low power levels. Therefore, the devices are ideal for powering battery management ICs. Specifically, since the devices are enabled as soon as the applied voltage reaches the minimum input voltage, the output is quickly available to power continuously operating battery charging ICs.

The usual PNP pass transistor has been replaced by a PMOS pass element. Because the PMOS pass element behaves as a low-value resistor, the low dropout voltage, typically 415 mV at 50 mA of load current, is directly proportional to the load current. The low quiescent current (3.2 μA typically) is stable over the entire range of output load current (0 mA to 50 mA).

APPLICATIONS

- Ultra Low Power Microcontrollers
- Cellular/Cordless Handsets
- Portable/Battery-Powered Equipment

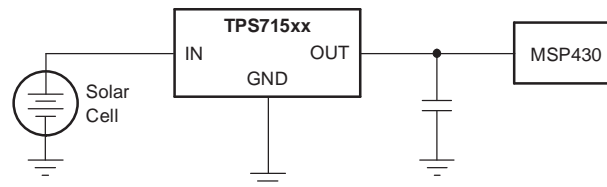
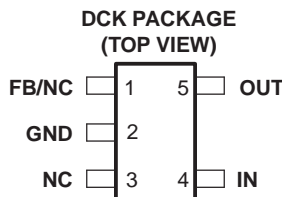

Please be aware that an important notice concerning availability, standard warranty, and use in critical applications of Texas Instruments semiconductor products and disclaimers thereto appears at the end of this data sheet.

All trademarks are the property of their respective owners.



This integrated circuit can be damaged by ESD. Texas Instruments recommends that all integrated circuits be handled with appropriate precautions. Failure to observe proper handling and installation procedures can cause damage.

ESD damage can range from subtle performance degradation to complete device failure. Precision integrated circuits may be more susceptible to damage because very small parametric changes could cause the device not to meet its published specifications.

ORDERING INFORMATION⁽¹⁾

| PRODUCT | V _{OUT} ⁽²⁾ |
|--------------|---|
| TPS715xxyyyz | XX is nominal output voltage (for example, 28 = 2.8 V, 285 = 2.85 V, 01 = Adjustable). YYY is package designator. Z is package quantity. |

- (1) For the most current package and ordering information see the Package Option Addendum at the end of this document, or see the TI web site at www.ti.com.
- (2) Output voltages from 1.25 V to 5.4 V in 50 mV increments are available through the use of innovative factory EEPROM programming; minimum order quantities may apply. Contact factory for details and availability.

ABSOLUTE MAXIMUM RATINGS

over operating temperature range (unless otherwise noted)⁽¹⁾⁽²⁾

| | UNIT |
|---|------------------------------|
| V _{IN} range | –0.3 V to +24 V |
| V _{OUT} range | –0.3 V to +16.5 V |
| Peak output current | Internally limited |
| ESD rating, HBM | 2 kV |
| ESD rating, CDM | 500 V |
| Continuous total power dissipation | See Dissipation Rating Table |
| Junction temperature range, T _J | –40°C to +150°C |
| Storage temperature range, T _{stg} | –65°C to +150°C |

- (1) Stresses beyond those listed under *absolute maximum ratings* may cause permanent damage to the device. These are stress ratings only, and functional operation of the device at these or any other conditions beyond those indicated under *recommended operating conditions* is not implied. Exposure to absolute-maximum-rated conditions for extended periods may affect device reliability.
- (2) All voltage values are with respect to network ground terminal.

DISSIPATION RATING TABLE

| BOARD | PACKAGE | R _{θJC} °C/W | R _{θJA} °C/W | DERATING FACTOR ABOVE T _A = +25°C | T _A ≤ 25°C POWER RATING | T _A = +70°C POWER RATING | T _A = +85°C POWER RATING |
|-----------------------|---------|-----------------------|-----------------------|--|------------------------------------|-------------------------------------|-------------------------------------|
| Low-K ⁽¹⁾ | DCK | 165 | 395 | 2.52 mW/°C | 250 mW | 140 mW | 100 mW |
| High-K ⁽²⁾ | DCK | 165 | 315 | 3.18 mW/°C | 320 mW | 175 mW | 130 mW |

- (1) The JEDEC Low-K (1s) board design used to derive this data was a 3 inch × 3 inch, two-layer board with 2 ounce copper traces on top of the board.
- (2) The JEDEC High-K (2s2p) board design used to derive this data was a 3 inch × 3 inch, multilayer board with 1 ounce internal power and ground planes and 2 ounce copper traces on top and bottom of the board.

ELECTRICAL CHARACTERISTICS

Over operating junction temperature range ($T_J = -40^\circ\text{C}$ to $+125^\circ\text{C}$), $V_{IN} = V_{OUT(NOM)} + 1\text{ V}$, $I_{OUT} = 1\text{ mA}$, and $C_{OUT} = 1\text{ }\mu\text{F}$, unless otherwise noted. Typical values are at $T_J = +25^\circ\text{C}$.

| PARAMETER | | TEST CONDITIONS | MIN | TYP | MAX | UNIT |
|---|-----------------------------------|---|------|-----|------|---------------------|
| Input voltage ⁽¹⁾ | V_{IN} | $I_O = 10\text{ mA}$ | 2.5 | | 24 | V |
| | | $I_O = 50\text{ mA}$ | 3 | | 24 | |
| V_{OUT} voltage range (TPS71501) | | | 1.2 | | 15 | V |
| V_{OUT} accuracy ⁽¹⁾ | Over V_{IN} , I_{OUT} , and T | $V_{IN} + 1.0\text{ V} \leq V_{IN} \leq 24\text{ V}$ $100\text{ }\mu\text{A} \leq I_{OUT} \leq 50\text{ mA}$ | -4.0 | | +4.0 | % |
| Ground pin current ⁽²⁾ | I_{GND} | $0 \leq I_{OUT} \leq 50\text{ mA}$, $T_J = -40^\circ\text{C}$ to $+85^\circ\text{C}$ | | 3.2 | 4.2 | μA |
| | | $0\text{ mA} \leq I_{OUT} \leq 50\text{ mA}$ | | 3.2 | 4.8 | |
| | | $0\text{ mA} \leq I_{OUT} \leq 50\text{ mA}$, $V_{IN} = 24\text{ V}$ | | | 5.8 | |
| Load regulation | $\Delta V_{OUT}/\Delta I_{OUT}$ | $I_{OUT} = 100\text{ }\mu\text{A}$ to 50 mA | | 22 | | mV |
| Output voltage line regulation ⁽¹⁾ | $\Delta V_{OUT}/\Delta V_{IN}$ | $V_{OUT} + 1\text{ V} < V_{IN} \leq 24\text{ V}$ | | 20 | 60 | mV |
| Output noise voltage | V_n | BW = 200 Hz to 100 kHz, $C_{OUT} = 10\text{ }\mu\text{F}$, $I_{OUT} = 50\text{ mA}$ | | 575 | | μV_{rms} |
| Output current limit | I_{CL} | $V_{OUT} = 0\text{ V}$, $V_{IN} \geq 3.5\text{ V}$ | 125 | | 750 | mA |
| | | $V_{OUT} = 0\text{ V}$, $V_{IN} < 3.5\text{ V}$ | 90 | | 750 | mA |
| Power-supply ripple rejection | PSRR | $f = 100\text{ kHz}$, $C_{OUT} = 10\text{ }\mu\text{F}$ | | 60 | | dB |
| Dropout voltage $V_{IN} = V_{OUT(NOM)} - 1\text{ V}$ | V_{DO} | $I_{OUT} = 50\text{ mA}$ | | 415 | 750 | mV |

(1) Minimum $V_{IN} = V_{OUT} + V_{DO}$ or the value shown for *Input voltage* in this table, whichever is greater.

(2) See [Figure 1](#). The TPS715xx family employs a leakage null control circuit. This circuit is active only if output current is less than pass FET leakage current. The circuit is typically active when output load is less than $5\text{ }\mu\text{A}$, V_{IN} is greater than 18 V, and die temperature is greater than 100°C .

FUNCTIONAL BLOCK DIAGRAMS

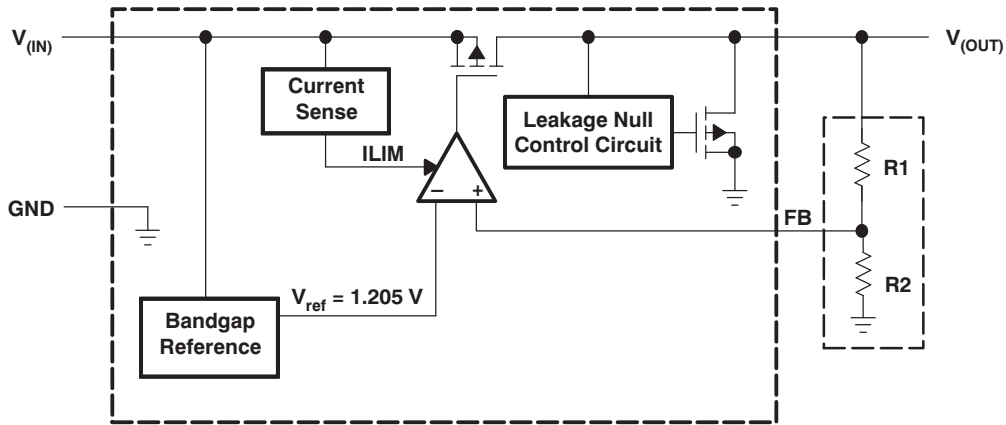

Figure 1. Functional Block Diagram—Adjustable Version

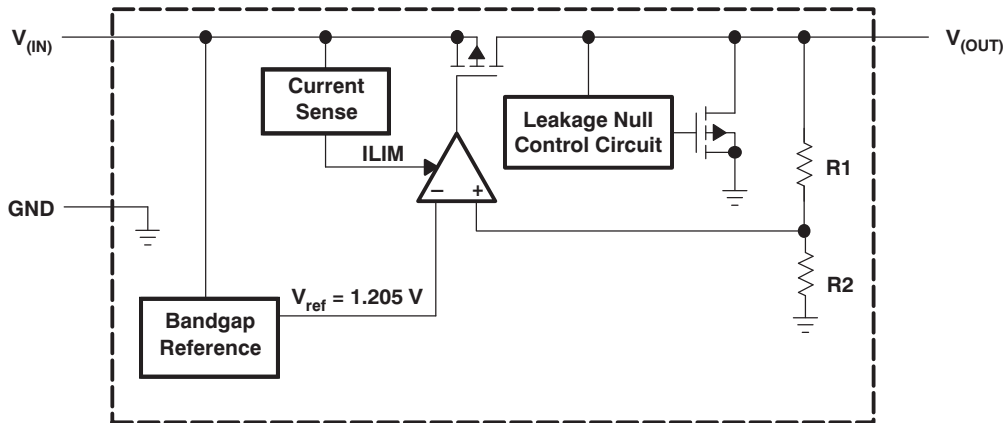

Figure 2. Functional Block Diagram—Fixed Version

Table 1. Terminal Functions

| TERMINAL | | | DESCRIPTION |
|----------|-------|------|--|
| NAME | NO. | | |
| | FIXED | ADJ. | |
| FB | | 1 | Adjustable version. This terminal is used to set the output voltage. |
| NC | 1 | | No connection |
| GND | 2 | 2 | Ground |
| NC | 3 | 3 | No connection |
| IN | 4 | 4 | Input supply. |
| OUT | 5 | 5 | Output of the regulator, any output capacitor $\geq 0.47 \mu\text{F}$ can be used for stability. |

TYPICAL CHARACTERISTICS

OUTPUT VOLTAGE
vs
OUTPUT CURRENT

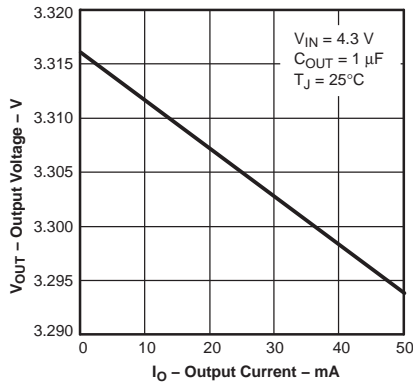

Figure 3.

OUTPUT VOLTAGE
vs
JUNCTION TEMPERATURE

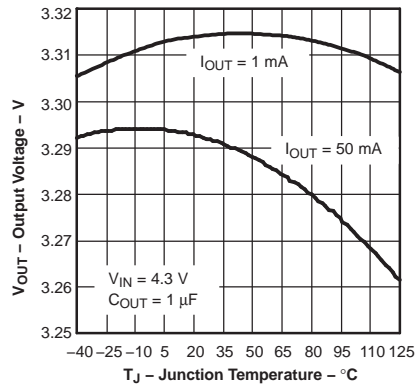

Figure 4.

QUIESCENT CURRENT
vs
JUNCTION TEMPERATURE

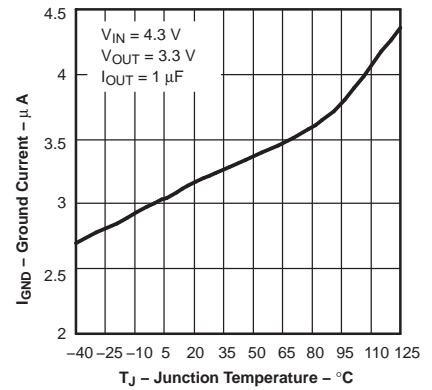

Figure 5.

OUTPUT SPECTRAL
NOISE DENSITY
vs
FREQUENCY

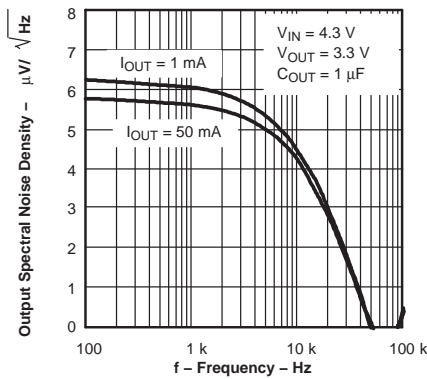

Figure 6.

OUTPUT IMPEDANCE
vs
FREQUENCY

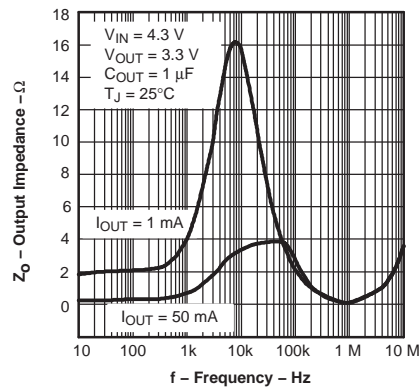

Figure 7.

DROPOUT VOLTAGE
vs
OUTPUT CURRENT

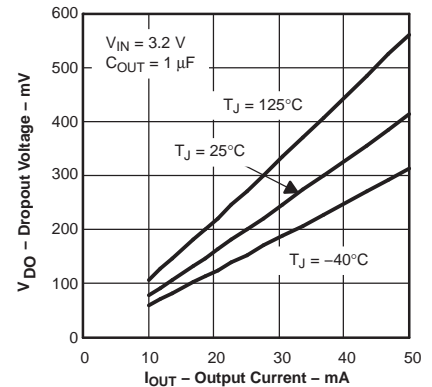

Figure 8.

TPS71501
DROPOUT VOLTAGE
vs
INPUT VOLTAGE

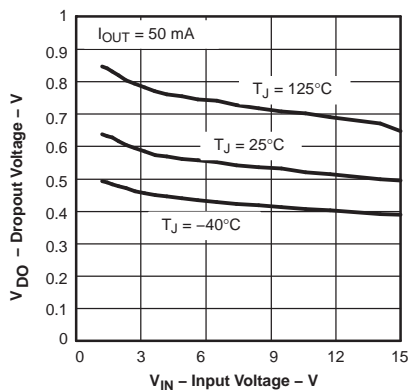

Figure 9.

DROPOUT VOLTAGE
vs
JUNCTION TEMPERATURE

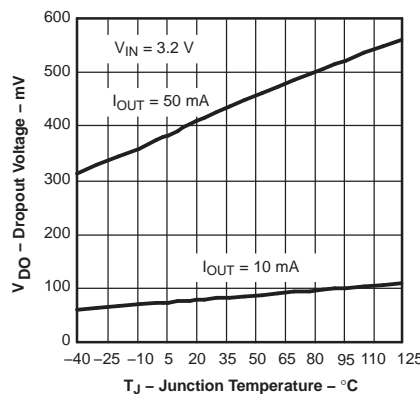

Figure 10.

POWER-SUPPLY
RIPPLE REJECTION
vs
FREQUENCY

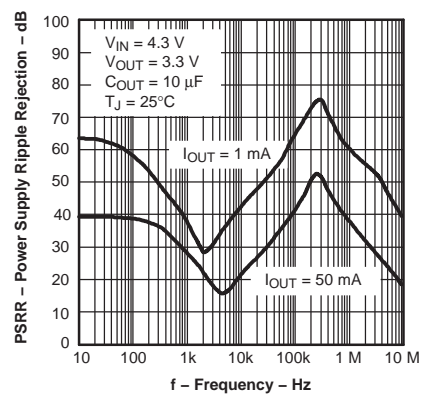

Figure 11.

TYPICAL CHARACTERISTICS (continued)

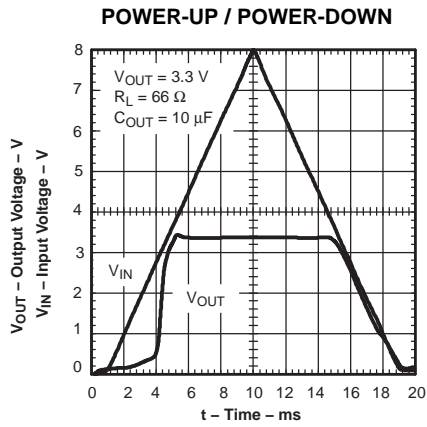

Figure 12.

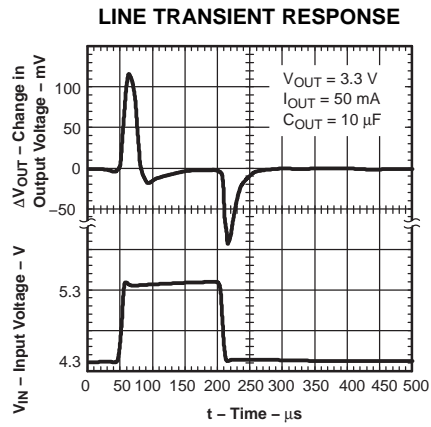

Figure 13.

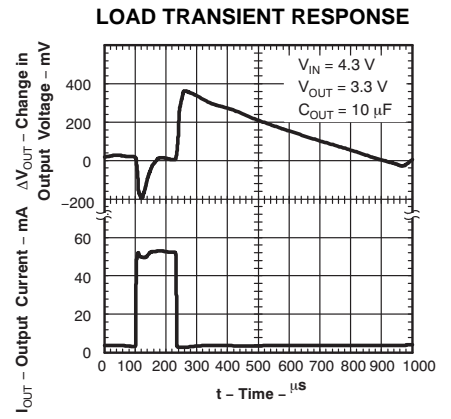

Figure 14.

APPLICATION INFORMATION

The TPS715xx family of LDO regulators has been optimized for ultra-low power applications such as the [MSP430](#) microcontroller. Its ultra-low supply current maximizes efficiency at light loads, and its high input voltage range makes it suitable for supplies such as unconditioned solar panels.

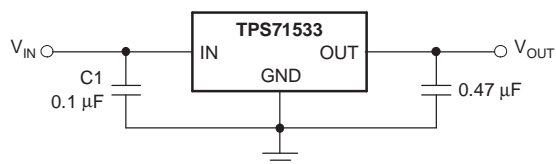

Figure 15. Typical Application Circuit (Fixed Voltage Version)

External Capacitor Requirements

Although not required, a 0.047- μF or larger input bypass capacitor, connected between IN and GND and located close to the device, is recommended to improve transient response and noise rejection of the power supply as a whole. A higher-value input capacitor may be necessary if large, fast-rise-time load transients are anticipated and the device is located several inches from the power source.

The TPS715xx requires an output capacitor connected between OUT and GND to stabilize the internal control loop. Any capacitor (including ceramic and tantalum) $\geq 0.47 \mu\text{F}$ properly stabilizes this loop. X7R type capacitors are recommended but X5R and others may be used.

Power Dissipation and Junction Temperature

To ensure reliable operation, worst-case junction temperature should not exceed $+125^\circ\text{C}$. This restriction limits the power dissipation the regulator can handle in any given application. To ensure the junction temperature is within acceptable limits, calculate the maximum allowable dissipation, $P_{D(\text{max})}$, and the actual dissipation, P_D , which must be less than or equal to $P_{D(\text{max})}$.

The maximum-power-dissipation limit is determined using the following equation:

$$P_{D(\text{max})} = \frac{T_{J\text{max}} - T_A}{R_{\theta\text{JA}}} \quad (1)$$

where:

- $T_{J\text{max}}$ is the maximum allowable junction temperature.
- $R_{\theta\text{JA}}$ is the thermal resistance junction-to-ambient for the package (see the [Dissipation Ratings](#) table).
- T_A is the ambient temperature.

The regulator dissipation is calculated using:

$$P_D = (V_{\text{IN}} - V_{\text{OUT}}) \times I_{\text{OUT}} \quad (2)$$

For a higher power package version of the TPS715xx, see the [TPS715Axx](#).

Regulator Protection

The TPS715xx PMOS-pass transistor has a built-in back diode that conducts reverse current when the input voltage drops below the output voltage (e.g., during power-down). Current is conducted from the output to the input and is not internally limited. If extended reverse voltage operation is anticipated, external limiting might be appropriate.

The TPS715xx features internal current limiting. During normal operation, the TPS715xx limits output current to approximately 500 mA. When current limiting engages, the output voltage scales back linearly until the overcurrent condition ends. Take care not to exceed the power dissipation ratings of the package.

APPLICATION INFORMATION (continued)

Programming the TPS71501 Adjustable LDO Regulator

The output voltage of the TPS71501 adjustable regulator is programmed using an external resistor divider as shown in Figure 16. The output voltage operating range is 1.2 V to 15 V, and is calculated using:

$$V_{OUT} = V_{REF} \times \left(1 + \frac{R1}{R2}\right) \quad (3)$$

where:

- $V_{REF} = 1.205$ V typ (the internal reference voltage)

Resistors R1 and R2 should be chosen for approximately 1.5- μ A divider current. Lower value resistors can be used for improved noise performance, but the solution consumes more power. Higher resistor values should be avoided as leakage current into/out of FB across R1/R2 creates an offset voltage that artificially increases/decreases the feedback voltage and thus erroneously decreases/increases V_{OUT} . The recommended design procedure is to choose $R2 = 1$ M Ω to set the divider current at 1.5 μ A, and then calculate R1 using Equation 4:

$$R1 = \left(\frac{V_{OUT}}{V_{REF}} - 1\right) \times R2 \quad (4)$$

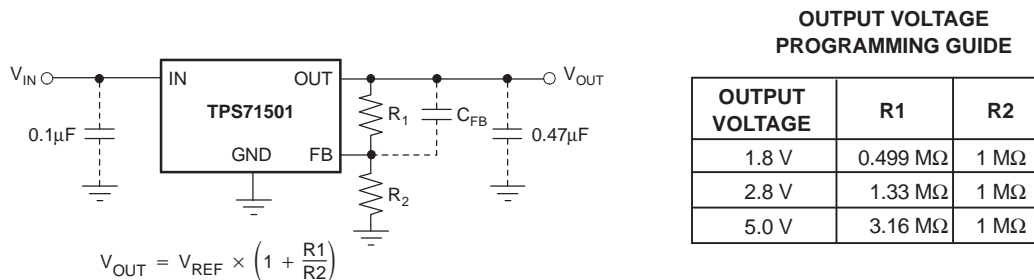

Figure 16. TPS71501 Adjustable LDO Regulator Programming

Power the MSP430 Microcontroller

Several versions of the TPS715xx are ideal for powering the MSP430 microcontroller. Table 2 shows potential applications of some voltage versions.

Table 2. Typical MSP430 Applications

| DEVICE | V_{OUT} (TYP) | APPLICATION |
|-----------|-----------------|---|
| TPS71519 | 1.9 V | $V_{OUT, MIN} > 1.800$ V required by many MSP430s. Allows lowest power consumption operation. |
| TPS71523 | 2.3 V | $V_{OUT, MIN} > 2.200$ V required by some MSP430s FLASH operation. |
| TPS71530 | 3.0 V | $V_{OUT, MIN} > 2.700$ V required by some MSP430s FLASH operation. |
| TPS715345 | 3.45 V | $V_{OUT, MIN} < 3.600$ V required by some MSP430s. Allows highest speed operation. |

The TPS715xx family offers many output voltage versions to allow designers to minimize the supply voltage for the processing speed required of the MSP430. This minimizes the supply current consumed by the MSP430.

PACKAGING INFORMATION

| Orderable Device | Status ⁽¹⁾ | Package Type | Package Drawing | Pins | Package Qty | Eco Plan ⁽²⁾ | Lead/Ball Finish | MSL Peak Temp ⁽³⁾ |
|------------------|-----------------------|--------------|-----------------|------|-------------|-------------------------|------------------|------------------------------|
| BQ71525DCKR | ACTIVE | SC70 | DCK | 5 | 3000 | Green (RoHS & no Sb/Br) | CU NIPDAU | Level-1-260C-UNLIM |
| BQ71525DCKRG4 | ACTIVE | SC70 | DCK | 5 | 3000 | Green (RoHS & no Sb/Br) | CU NIPDAU | Level-1-260C-UNLIM |
| BQ71533DCKR | ACTIVE | SC70 | DCK | 5 | 3000 | Green (RoHS & no Sb/Br) | CU NIPDAU | Level-1-260C-UNLIM |
| BQ71533DCKRG4 | ACTIVE | SC70 | DCK | 5 | 3000 | Green (RoHS & no Sb/Br) | CU NIPDAU | Level-1-260C-UNLIM |
| TPS71501DCKR | ACTIVE | SC70 | DCK | 5 | 3000 | Green (RoHS & no Sb/Br) | CU NIPDAU | Level-1-260C-UNLIM |
| TPS71501DCKRG4 | ACTIVE | SC70 | DCK | 5 | 3000 | Green (RoHS & no Sb/Br) | CU NIPDAU | Level-1-260C-UNLIM |
| TPS71518DCKR | ACTIVE | SC70 | DCK | 5 | 3000 | Green (RoHS & no Sb/Br) | CU NIPDAU | Level-1-260C-UNLIM |
| TPS71518DCKRG4 | ACTIVE | SC70 | DCK | 5 | 3000 | Green (RoHS & no Sb/Br) | CU NIPDAU | Level-1-260C-UNLIM |
| TPS71519DCKR | ACTIVE | SC70 | DCK | 5 | 3000 | Green (RoHS & no Sb/Br) | CU NIPDAU | Level-1-260C-UNLIM |
| TPS71519DCKRG4 | ACTIVE | SC70 | DCK | 5 | 3000 | Green (RoHS & no Sb/Br) | CU NIPDAU | Level-1-260C-UNLIM |
| TPS71523DCKR | ACTIVE | SC70 | DCK | 5 | 3000 | Green (RoHS & no Sb/Br) | CU NIPDAU | Level-1-260C-UNLIM |
| TPS71523DCKRG4 | ACTIVE | SC70 | DCK | 5 | 3000 | Green (RoHS & no Sb/Br) | CU NIPDAU | Level-1-260C-UNLIM |
| TPS71525DCKR | ACTIVE | SC70 | DCK | 5 | 3000 | Green (RoHS & no Sb/Br) | CU NIPDAU | Level-1-260C-UNLIM |
| TPS71525DCKRG4 | ACTIVE | SC70 | DCK | 5 | 3000 | Green (RoHS & no Sb/Br) | CU NIPDAU | Level-1-260C-UNLIM |
| TPS71530DCKR | ACTIVE | SC70 | DCK | 5 | 3000 | Green (RoHS & no Sb/Br) | CU NIPDAU | Level-1-260C-UNLIM |
| TPS71530DCKRG4 | ACTIVE | SC70 | DCK | 5 | 3000 | Green (RoHS & no Sb/Br) | CU NIPDAU | Level-1-260C-UNLIM |
| TPS71533DCKR | ACTIVE | SC70 | DCK | 5 | 3000 | Green (RoHS & no Sb/Br) | CU NIPDAU | Level-1-260C-UNLIM |
| TPS71533DCKRG4 | ACTIVE | SC70 | DCK | 5 | 3000 | Green (RoHS & no Sb/Br) | CU NIPDAU | Level-1-260C-UNLIM |
| TPS715345DCKR | ACTIVE | SC70 | DCK | 5 | 3000 | Green (RoHS & no Sb/Br) | CU NIPDAU | Level-1-260C-UNLIM |
| TPS715345DCKRG4 | ACTIVE | SC70 | DCK | 5 | 3000 | Green (RoHS & no Sb/Br) | CU NIPDAU | Level-1-260C-UNLIM |
| TPS71550DCKR | ACTIVE | SC70 | DCK | 5 | 3000 | Green (RoHS & no Sb/Br) | CU NIPDAU | Level-1-260C-UNLIM |
| TPS71550DCKRG4 | ACTIVE | SC70 | DCK | 5 | 3000 | Green (RoHS & no Sb/Br) | CU NIPDAU | Level-1-260C-UNLIM |

⁽¹⁾ The marketing status values are defined as follows:

ACTIVE: Product device recommended for new designs.

LIFEBUY: TI has announced that the device will be discontinued, and a lifetime-buy period is in effect.

NRND: Not recommended for new designs. Device is in production to support existing customers, but TI does not recommend using this part in a new design.

PREVIEW: Device has been announced but is not in production. Samples may or may not be available.

OBSOLETE: TI has discontinued the production of the device.

⁽²⁾ Eco Plan - The planned eco-friendly classification: Pb-Free (RoHS), Pb-Free (RoHS Exempt), or Green (RoHS & no Sb/Br) - please check <http://www.ti.com/productcontent> for the latest availability information and additional product content details.

TBD: The Pb-Free/Green conversion plan has not been defined.

Pb-Free (RoHS): TI's terms "Lead-Free" or "Pb-Free" mean semiconductor products that are compatible with the current RoHS requirements for all 6 substances, including the requirement that lead not exceed 0.1% by weight in homogeneous materials. Where designed to be soldered at high temperatures, TI Pb-Free products are suitable for use in specified lead-free processes.

Pb-Free (RoHS Exempt): This component has a RoHS exemption for either 1) lead-based flip-chip solder bumps used between the die and package, or 2) lead-based die adhesive used between the die and leadframe. The component is otherwise considered Pb-Free (RoHS compatible) as defined above.

Green (RoHS & no Sb/Br): TI defines "Green" to mean Pb-Free (RoHS compatible), and free of Bromine (Br) and Antimony (Sb) based flame retardants (Br or Sb do not exceed 0.1% by weight in homogeneous material)

⁽³⁾ MSL, Peak Temp. -- The Moisture Sensitivity Level rating according to the JEDEC industry standard classifications, and peak solder temperature.

Important Information and Disclaimer:The information provided on this page represents TI's knowledge and belief as of the date that it is provided. TI bases its knowledge and belief on information provided by third parties, and makes no representation or warranty as to the accuracy of such information. Efforts are underway to better integrate information from third parties. TI has taken and continues to take reasonable steps to provide representative and accurate information but may not have conducted destructive testing or chemical analysis on incoming materials and chemicals. TI and TI suppliers consider certain information to be proprietary, and thus CAS numbers and other limited information may not be available for release.

In no event shall TI's liability arising out of such information exceed the total purchase price of the TI part(s) at issue in this document sold by TI to Customer on an annual basis.

TAPE AND REEL INFORMATION

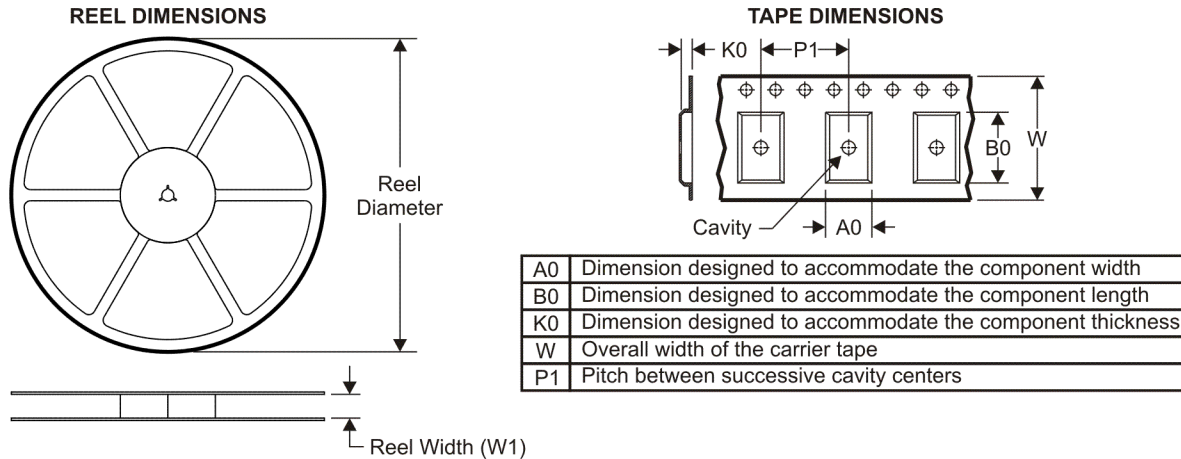

QUADRANT ASSIGNMENTS FOR PIN 1 ORIENTATION IN TAPE



*All dimensions are nominal

| Device | Package Type | Package Drawing | Pins | SPQ | Reel Diameter (mm) | Reel Width W1 (mm) | A0 (mm) | B0 (mm) | K0 (mm) | P1 (mm) | W (mm) | Pin1 Quadrant |
|---------------|--------------|-----------------|------|------|--------------------|--------------------|---------|---------|---------|---------|--------|---------------|
| BQ71525DCKR | SC70 | DCK | 5 | 3000 | 180.0 | 9.2 | 2.24 | 1.22 | 2.34 | 4.0 | 8.0 | Q3 |
| BQ71533DCKR | SC70 | DCK | 5 | 3000 | 180.0 | 9.2 | 2.24 | 1.22 | 2.34 | 4.0 | 8.0 | Q3 |
| TPS71501DCKR | SC70 | DCK | 5 | 3000 | 180.0 | 9.2 | 2.24 | 1.22 | 2.34 | 4.0 | 8.0 | Q3 |
| TPS71518DCKR | SC70 | DCK | 5 | 3000 | 180.0 | 9.2 | 2.24 | 1.22 | 2.34 | 4.0 | 8.0 | Q3 |
| TPS71519DCKR | SC70 | DCK | 5 | 3000 | 180.0 | 9.2 | 2.24 | 1.22 | 2.34 | 4.0 | 8.0 | Q3 |
| TPS71523DCKR | SC70 | DCK | 5 | 3000 | 180.0 | 9.2 | 2.24 | 1.22 | 2.34 | 4.0 | 8.0 | Q3 |
| TPS71525DCKR | SC70 | DCK | 5 | 3000 | 180.0 | 9.2 | 2.24 | 1.22 | 2.34 | 4.0 | 8.0 | Q3 |
| TPS71530DCKR | SC70 | DCK | 5 | 3000 | 180.0 | 9.2 | 2.24 | 1.22 | 2.34 | 4.0 | 8.0 | Q3 |
| TPS71533DCKR | SC70 | DCK | 5 | 3000 | 180.0 | 9.2 | 2.24 | 1.22 | 2.34 | 4.0 | 8.0 | Q3 |
| TPS715345DCKR | SC70 | DCK | 5 | 3000 | 180.0 | 9.2 | 2.24 | 1.22 | 2.34 | 4.0 | 8.0 | Q3 |
| TPS71550DCKR | SC70 | DCK | 5 | 3000 | 180.0 | 9.2 | 2.24 | 1.22 | 2.34 | 4.0 | 8.0 | Q3 |

TAPE AND REEL BOX DIMENSIONS



*All dimensions are nominal

| Device | Package Type | Package Drawing | Pins | SPQ | Length (mm) | Width (mm) | Height (mm) |
|---------------|--------------|-----------------|------|------|-------------|------------|-------------|
| BQ71525DCKR | SC70 | DCK | 5 | 3000 | 180.0 | 180.0 | 85.0 |
| BQ71533DCKR | SC70 | DCK | 5 | 3000 | 180.0 | 180.0 | 85.0 |
| TPS71501DCKR | SC70 | DCK | 5 | 3000 | 180.0 | 180.0 | 85.0 |
| TPS71518DCKR | SC70 | DCK | 5 | 3000 | 180.0 | 180.0 | 85.0 |
| TPS71519DCKR | SC70 | DCK | 5 | 3000 | 180.0 | 180.0 | 85.0 |
| TPS71523DCKR | SC70 | DCK | 5 | 3000 | 180.0 | 180.0 | 85.0 |
| TPS71525DCKR | SC70 | DCK | 5 | 3000 | 180.0 | 180.0 | 85.0 |
| TPS71530DCKR | SC70 | DCK | 5 | 3000 | 180.0 | 180.0 | 85.0 |
| TPS71533DCKR | SC70 | DCK | 5 | 3000 | 180.0 | 180.0 | 85.0 |
| TPS715345DCKR | SC70 | DCK | 5 | 3000 | 180.0 | 180.0 | 85.0 |
| TPS71550DCKR | SC70 | DCK | 5 | 3000 | 180.0 | 180.0 | 85.0 |

DCK (R-PDSO-G5)

PLASTIC SMALL-OUTLINE PACKAGE

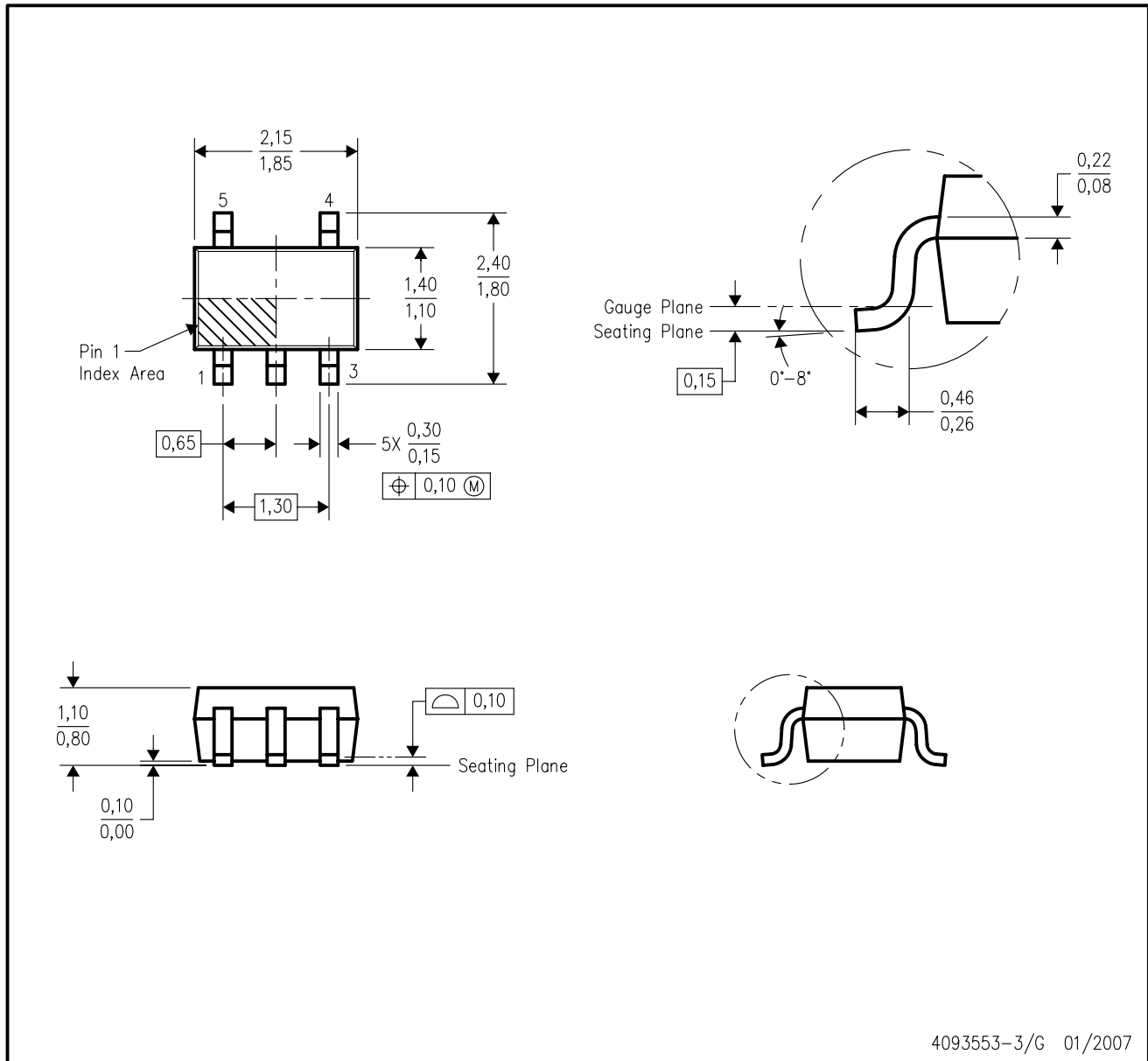

- NOTES:
- A. All linear dimensions are in millimeters.
 - B. This drawing is subject to change without notice.
 - C. Body dimensions do not include mold flash or protrusion. Mold flash and protrusion shall not exceed 0.15 per side.
 - D. Falls within JEDEC MO-203 variation AA.

IMPORTANT NOTICE

Texas Instruments Incorporated and its subsidiaries (TI) reserve the right to make corrections, modifications, enhancements, improvements, and other changes to its products and services at any time and to discontinue any product or service without notice. Customers should obtain the latest relevant information before placing orders and should verify that such information is current and complete. All products are sold subject to TI's terms and conditions of sale supplied at the time of order acknowledgment.

TI warrants performance of its hardware products to the specifications applicable at the time of sale in accordance with TI's standard warranty. Testing and other quality control techniques are used to the extent TI deems necessary to support this warranty. Except where mandated by government requirements, testing of all parameters of each product is not necessarily performed.

TI assumes no liability for applications assistance or customer product design. Customers are responsible for their products and applications using TI components. To minimize the risks associated with customer products and applications, customers should provide adequate design and operating safeguards.

TI does not warrant or represent that any license, either express or implied, is granted under any TI patent right, copyright, mask work right, or other TI intellectual property right relating to any combination, machine, or process in which TI products or services are used. Information published by TI regarding third-party products or services does not constitute a license from TI to use such products or services or a warranty or endorsement thereof. Use of such information may require a license from a third party under the patents or other intellectual property of the third party, or a license from TI under the patents or other intellectual property of TI.

Reproduction of TI information in TI data books or data sheets is permissible only if reproduction is without alteration and is accompanied by all associated warranties, conditions, limitations, and notices. Reproduction of this information with alteration is an unfair and deceptive business practice. TI is not responsible or liable for such altered documentation. Information of third parties may be subject to additional restrictions.

Resale of TI products or services with statements different from or beyond the parameters stated by TI for that product or service voids all express and any implied warranties for the associated TI product or service and is an unfair and deceptive business practice. TI is not responsible or liable for any such statements.

TI products are not authorized for use in safety-critical applications (such as life support) where a failure of the TI product would reasonably be expected to cause severe personal injury or death, unless officers of the parties have executed an agreement specifically governing such use. Buyers represent that they have all necessary expertise in the safety and regulatory ramifications of their applications, and acknowledge and agree that they are solely responsible for all legal, regulatory and safety-related requirements concerning their products and any use of TI products in such safety-critical applications, notwithstanding any applications-related information or support that may be provided by TI. Further, Buyers must fully indemnify TI and its representatives against any damages arising out of the use of TI products in such safety-critical applications.

TI products are neither designed nor intended for use in military/aerospace applications or environments unless the TI products are specifically designated by TI as military-grade or "enhanced plastic." Only products designated by TI as military-grade meet military specifications. Buyers acknowledge and agree that any such use of TI products which TI has not designated as military-grade is solely at the Buyer's risk, and that they are solely responsible for compliance with all legal and regulatory requirements in connection with such use.

TI products are neither designed nor intended for use in automotive applications or environments unless the specific TI products are designated by TI as compliant with ISO/TS 16949 requirements. Buyers acknowledge and agree that, if they use any non-designated products in automotive applications, TI will not be responsible for any failure to meet such requirements.

Following are URLs where you can obtain information on other Texas Instruments products and application solutions:

Products

| | |
|-----------------------------|--|
| Amplifiers | amplifier.ti.com |
| Data Converters | dataconverter.ti.com |
| DSP | dsp.ti.com |
| Clocks and Timers | www.ti.com/clocks |
| Interface | interface.ti.com |
| Logic | logic.ti.com |
| Power Mgmt | power.ti.com |
| Microcontrollers | microcontroller.ti.com |
| RFID | www.ti-rfid.com |
| RF/IF and ZigBee® Solutions | www.ti.com/lprf |

Applications

| | |
|--------------------|--|
| Audio | www.ti.com/audio |
| Automotive | www.ti.com/automotive |
| Broadband | www.ti.com/broadband |
| Digital Control | www.ti.com/digitalcontrol |
| Medical | www.ti.com/medical |
| Military | www.ti.com/military |
| Optical Networking | www.ti.com/opticalnetwork |
| Security | www.ti.com/security |
| Telephony | www.ti.com/telephony |
| Video & Imaging | www.ti.com/video |
| Wireless | www.ti.com/wireless |

Mailing Address: Texas Instruments, Post Office Box 655303, Dallas, Texas 75265
Copyright © 2008, Texas Instruments Incorporated