



## POWER AND BATTERY MANAGEMENT IC FOR Li-ION POWERED SYSTEMS

### FEATURES

- Linear Charger Management for Single Li-Ion or Li-Polymer Cells
- Dual Input Ports for Charging From USB or From Wall Plug, Handles 100-mA / 500-mA USB Requirements
- Charge Current Programmable Via External Resistor
- 1 A, 95% Efficient Step-Down Converter for I/O and Peripheral Components (VMAIN)
- 400 mA, 90% Efficient Step-Down Converter for Processor Core (VCORE)
- 2x 200-mA LDOs for I/O and Peripheral Components, LDO Enable via Bus
- Serial Interface Compatible With I<sup>2</sup>C, Supports 100-kHz, 400-kHz Operation
- LOW\_PWR Pin to Lower or Disable Processor Core Supply Voltage in Deep Sleep Mode
- 70- $\mu$ A Quiescent Current
- 1% Reference Voltage
- Thermal Shutdown Protection

### APPLICATIONS

- All Single Li-Ion Cell Operated Products Requiring Multiple Supplies Including:
  - PDA
  - Cellular/Smart Phone
  - Internet Audio Player
  - Digital Still Camera
- Digital Radio Player
- Split Supply DSP and  $\mu$ P Solutions

### DESCRIPTION

The TPS65010 is an integrated power and battery management IC for applications powered by one Li-Ion or Li-Polymer cell, and which require multiple power rails. The TPS65010 provides two highly efficient, step-down converters targeted at providing the core voltage and peripheral, I/O rails in a processor-based system. Both step-down converters enter a low power mode at light load for maximum efficiency across the widest possible range of load currents. The LOW\_PWR pin allows the core converter to lower its output voltage when the application processor goes into deep sleep. The TPS65010 also integrates two 200-mA LDO voltage regulators, which are enabled via the serial interface. Each LDO operates with an input voltage range between 1.8 V and 6.5 V, allowing them to be supplied from one of the step-down converters or directly from the battery.

The TPS65010 also has a highly integrated and flexible Li-Ion linear charger and system power management. It offers integrated USB-port and ac-adaptor supply management with autonomous power-source selection, power FET and current sensor, high accuracy current and voltage regulation, charge status, and charge termination.

The TPS65010 charger automatically selects the USB-Port or the ac-adaptor as the power source for the system. In the USB configuration, the host can increase the charge current from the default value of maximum 100 mA to 500 mA via the interface. In the ac-adaptor configuration an external resistor sets the maximum value of charge current.

The battery is charged in three phases: conditioning, constant current, and constant voltage. Charge is normally terminated based on minimum current. An internal charge timer provides a safety backup for charge termination. The TPS65010 automatically restarts the charge if the battery voltage falls below an internal threshold. The charger automatically enters sleep mode when both supplies are removed.



Please be aware that an important notice concerning availability, standard warranty, and use in critical applications of Texas Instruments semiconductor products and disclaimers thereto appears at the end of this data sheet.

I<sup>2</sup>C is a trademark of Phillips.

PowerPAD is a trademark of Texas Instruments.



These devices have limited built-in ESD protection. The leads should be shorted together or the device placed in conductive foam during storage or handling to prevent electrostatic damage to the MOS gates.

The serial interface can be used for dynamic voltage scaling, for collecting information on and controlling the battery charger status, for optionally controlling 2 LED driver outputs, a vibrator driver, masking interrupts, or for disabling/enabling and setting the LDO output voltages. The interface is compatible with the fast/standard mode I<sup>2</sup>C™ specification allowing transfers at up to 400 kHz.

**ORDERING INFORMATION**

T <sub>A</sub>	PACKAGE	PART NUMBER <sup>(1)</sup>
-40°C to 85°C	7 mm × 7 mm, 48-pin QFN	TPS65010RGZ

- (1) The RGZ package is available in tape and reel. Add R suffix (TPS65010RGZR) to order quantities of 2500 parts per reel. Add T suffix (TPS65010RGZT) to order quantities of 250 parts per reel.

**ABSOLUTE MAXIMUM RATINGS**

over operating free-air temperature range unless otherwise noted<sup>(1)</sup>

	UNIT
Input voltage on VAC pin with respect to AGND	20 V
Input voltage range on all other pins except AGND/PGND pins with respect to AGND	-0.3 V to 7 V
HBM and CBM capabilities at pins VIB, PG, and LED2	1 kV
Current at AC, VBAT, VINMAIN, L1, PGND1	1800 mA
Peak current at all other pins	1000 mA
Continuous power dissipation	See Dissipation Rating Table
Operating free-air temperature, T <sub>A</sub>	-40°C to 85°C
Maximum junction temperature, T <sub>J</sub>	125°C
Storage temperature, T <sub>stg</sub>	-65°C to 150°C
Lead temperature 1,6 mm (1/16 inch) from case for 10 seconds	260°C

- (1) Stresses beyond those listed under *absolute maximum ratings* may cause permanent damage to the device. These are stress ratings only, and functional operation of the device at these or any other conditions beyond those indicated under *recommended operating conditions* is not implied. Exposure to absolute-maximum-rated conditions for extended periods may affect device reliability.

**PACKAGE DISSIPATION RATINGS<sup>(1)</sup>**

AMBIENT TEMPERATURE	MAX POWER DISSIPATION FOR T <sub>J</sub> = 125°C <sup>(2)</sup>	DERATING FACTOR ABOVE T <sub>A</sub> = 55°C
25°C	3 W	30 mW/°C
55°C	2.1 W	

- (1) The TPS65010 is housed in a 48-pin QFN package with exposed leadframe on the underside. This 7 mm × 7 mm package exhibits a thermal impedance (junction-to-ambient) of 33 K/W when mounted on a JEDEC high-k board.  
 (2) Consideration needs to be given to the maximum charge current when the assembled application board exhibits a thermal impedance which differs significantly from the JEDEC high-k board.

**RECOMMENDED OPERATING CONDITIONS**

		<b>MIN</b>	<b>NOM</b>	<b>MAX</b>	<b>UNIT</b>
$V_{(AC)}$	Supply voltage from ac adapter	4.5		5.5	V
$V_{(USB)}$	Supply voltage from USB	4.4		5.25	V
$V_{(BAT)}$	Voltage at charger output/battery	2.5		4.2	V
$C_{I(AC)}$	Input capacitor at ac input		1		$\mu\text{F}$
$C_{I(USB)}$	Input capacitor at USB input		1		$\mu\text{F}$
$C_{I(BAT)}$	Input capacitor at VBAT output		0.1		$\mu\text{F}$
$V_{I(MAIN)}, V_{I(CORE)}, V_{CC}$	Input voltage range step-down convertors	2.5		6.0	V
$V_{O(MAIN)}$	Output voltage range for main step-down convertor	2.5		3.3	V
$V_{I(CORE)}$	Output voltage range for core step-down convertor	0.85		1.6	
$V_{I(LDO1)}, V_{I(LDO2)}$	Input voltage range for LDOs	1.8		6.5	V
$V_{O(LDO1-2)}$	Output voltage range for LDOs	0.9		$V_{I(LDO1-2)}$	V
$I_{O(L1)}$	Maximum output current at L1	1000			mA
$L_{(L1)}$	Inductor at L1 <sup>(1)</sup>		6.8		$\mu\text{H}$
$C_{I(VCC)}$	Input capacitor at VCC <sup>(1)</sup>		1		$\mu\text{F}$
$C_{I(MAIN)}$	Input capacitor at VINMAIN <sup>(1)</sup>		22		$\mu\text{F}$
$C_{I(CORE)}$	Input capacitor at VINCORE <sup>(1)</sup>		10		$\mu\text{F}$
$C_{O(1)}$	Output capacitor at VMAIN <sup>(1)</sup>		22		$\mu\text{F}$
$I_{O(L2)}$	Maximum output current at L2	400			mA
$L_{(L2)}$	Inductor at L2 <sup>(1)</sup>		10		$\mu\text{H}$
$C_{O(2)}$	Output capacitor at VCORE <sup>(1)</sup>		10		$\mu\text{F}$
$C_{I(1-2)}$	Input capacitor at VINLDO1, VINLDO2 <sup>(1)</sup>		1		$\mu\text{F}$
$C_{O(1-2)}$	Output capacitor at VLDO1-2 <sup>(1)</sup>		2.2		$\mu\text{F}$
$I_{O(LDO1,2)}$	Maximum output current at VLDO1,2	200			mA
$T_A$	Operating ambient temperature	-40		85	$^{\circ}\text{C}$
$T_J$	Operating junction temperature	-40		125	$^{\circ}\text{C}$
$R_{(CC)}$	Resistor from $V_{I(main)}, V_{I(core)}$ to $V_{CC}$ used for filtering, $C_{I(VCC)} = 1 \mu\text{F}$		10	100	$\Omega$

(1) See applications section for more information

**ELECTRICAL CHARACTERISTICS**

$V_{I(MAIN)} = V_{I(CORE)} = V_{CC} = V_{I(LDO1)} = V_{I(LDO2)} = 3.6 \text{ V}$ ,  $T_A = -40^{\circ}\text{C}$  to  $85^{\circ}\text{C}$ , typical values are at  $T_A = 25^{\circ}\text{C}$  battery charger specifications are valid in the range  $0^{\circ}\text{C} < T_A < 85^{\circ}\text{C}$  unless otherwise noted

<b>PARAMETER</b>		<b>TEST CONDITIONS</b>	<b>MIN</b>	<b>TYP</b>	<b>MAX</b>	<b>UNIT</b>
<b>Control Signals: LOW_PWR, SCLK, SDAT (Input)</b>						
$V_{IH}$	High level input voltage	$I_{IH} = 20 \mu\text{A}$ <sup>(1)</sup>	2		$V_{CC}$	V
$V_{IL}$	Low level input voltage	$I_{IL} = 10 \mu\text{A}$	0		0.8	V
$I_{IB}$	Input bias current			0.01	1.0	$\mu\text{A}$
<b>Control Signals: PB_ONOFF, HOT_RESET, BATT_COVER</b>						
$V_{IH}$	High level input voltage	$I_{IH} = 20 \mu\text{A}$ <sup>(1)</sup>	$0.8 V_{CC}$		6	V
$V_{IL}$	Low level input voltage	$I_{IL} = 10 \mu\text{A}$	0		0.4	V
$R_{(pb\_onoff)}$	Pulldown resistor at PB_ONOFF			1000		k $\Omega$
$R_{(hot\_reset)}$	Pullup resistor at HOT_RESET, connected to VCC			1000		k $\Omega$
$R_{(batt\_cover)}$	Pulldown resistor at BATT_COVER			2000		k $\Omega$
$t_{(glitch)}$	De-glitch time at all 3 pins		38	56	77	ms

(1) If the input voltage is higher than  $V_{CC}$ , an additional input current, limited by an internal 10-k resistor, flows.

**ELECTRICAL CHARACTERISTICS (continued)**

$V_{I(MAIN)} = V_{I(CORE)} = V_{CC} = V_{I(LDO1)} = V_{I(LDO2)} = 3.6\text{ V}$ ,  $T_A = -40^\circ\text{C}$  to  $85^\circ\text{C}$ , typical values are at  $T_A = 25^\circ\text{C}$  battery charger specifications are valid in the range  $0^\circ\text{C} < T_A < 85^\circ\text{C}$  unless otherwise noted

PARAMETER		TEST CONDITIONS	MIN	TYP	MAX	UNIT
$t_{(batt\_cover)}$	Delay after $t_{(glitch)}$ ( <b>PWRFAIL</b> goes low) before supplies are disabled when <b>BATT_COVER</b> goes low.		1.68	2.4	3.2	ms
<b>CONTROL SIGNALS: MPU_RESET, PWRFAIL, RESPWRON, INT, SDAT (output)</b>						
$V_{OH}$	High level output voltage				6	V
$V_{OL}$	Low level output voltage	$I_{IL} = 10\text{ mA}$	0		0.3	V
$t_{d(mpu\_nreset)}$	Duration of low pulse at <b>MPU_RESET</b>		100			$\mu\text{s}$
$t_{d(nrespwron)}$	Duration of low pulse at <b>RESPWRON</b> after <b>VLDO1</b> is in regulation	<b>CHGCONFIG</b> <7> = 0(Default)	800	1000	1200	ms
		<b>CHGCONFIG</b> <7> = 1	49	69	89	
$t_{d(uvlo)}$	Time between <b>UVLO</b> going active ( <b>PWRFAIL</b> going low) and supplies being disabled		1.68	2.4	3.2	ms
$t_{d(overtemp)}$	Time between chip overtemperature condition being recognized ( <b>PWRFAIL</b> going low) and supplies being disabled		1.68	2.4	3.2	ms
<b>SUPPLY PIN: VCC</b>						
$I_{(Q)}$	Operating quiescent current	$V_I = 3.6\text{ V}$ , current into Main + Core + $V_{CC}$			58	$\mu\text{A}$
$I_{O(SD)}$	Shutdown supply current	$V_I = 3.6\text{ V}$ , <b>BATT_COVER</b> = GND, Current into Main + Core + $V_{CC}$		15	25	$\mu\text{A}$
<b>VMAIN STEP-DOWN CONVERTER</b>						
$V_I$	Input voltage range		2.5		6.0	V
$I_O$	Maximum output current		1000			mA
$I_{O(SD)}$	Shutdown supply current	<b>BATT_COVER</b> = GND		0.1	1	$\mu\text{A}$
$r_{DS(on)}$	P-channel MOSFET on-resistance	$V_{I(MAIN)} = V_{GS} = 3.6\text{ V}$		110	210	$\text{m}\Omega$
$I_{lkg(p)}$	P-channel leakage current	$V_{(DS)} = 6.0\text{ V}$			1	$\mu\text{A}$
$r_{DS(on)}$	N-channel MOSFET on-resistance	$V_{I(MAIN)} = V_{GS} = 3.6\text{ V}$		110	200	$\text{m}\Omega$
$I_{lkg(N)}$	N-channel leakage current	$V_{(DS)} = 6.0\text{ V}$			1	$\mu\text{A}$
$I_L$	P-channel current limit	$2.5\text{ V} < V_{I(MAIN)} < 6.0\text{ V}$	1.4	1.75	2.1	A
$f_S$	Oscillator frequency		1	1.25	1.5	MHz
$V_{O(MAIN)}$	Fixed output voltage	2.5 V	$V_{I(MAIN)} = 2.7\text{ V}$ to $6.0\text{ V}$ ; $I_O = 0\text{ mA}$		0%	3%
			$V_{I(MAIN)} = 2.7\text{ V}$ to $6.0\text{ V}$ ; $0\text{ mA} \leq I_O \leq 1000\text{ mA}$		3%	3%
		2.75 V	$V_{I(MAIN)} = 2.95\text{ V}$ to $6.0\text{ V}$ ; $I_O = 0\text{ mA}$		0%	3%
			$V_{I(MAIN)} = 2.95\text{ V}$ to $6.0\text{ V}$ ; $0\text{ mA} \leq I_O \leq 1000\text{ mA}$		3%	3%
		3.0 V	$V_{I(MAIN)} = 3.2\text{ V}$ to $6.0\text{ V}$ ; $I_O = 0\text{ mA}$		0%	3%
			$V_{I(MAIN)} = 3.2\text{ V}$ to $6.0\text{ V}$ ; $0\text{ mA} \leq I_O \leq 1000\text{ mA}$		3%	3%
		3.3 V	$V_{I(MAIN)} = 3.5\text{ V}$ to $6.0\text{ V}$ ; $I_O = 0\text{ mA}$		0%	3%
			$V_{I(MAIN)} = 3.5\text{ V}$ to $6.0\text{ V}$ ; $0\text{ mA} \leq I_O \leq 1000\text{ mA}$		3%	3%
	Line regulation	$V_{I(MAIN)} = V_{O(MAIN)} + 0.5\text{ V}$ (min. $2.5\text{ V}$ ) to $6.0\text{ V}$ , $I_O = 10\text{ mA}$		0.5		%/V
	Load regulation	$I_O = 10\text{ mA}$ to $1000\text{ mA}$		0.12		%/A
$R_{(VMAIN)}$	VMAIN discharge resistance			400		$\Omega$

**ELECTRICAL CHARACTERISTICS (continued)**

$V_{I(MAIN)} = V_{I(CORE)} = V_{CC} = V_{I(LDO1)} = V_{I(LDO2)} = 3.6\text{ V}$ ,  $T_A = -40^\circ\text{C}$  to  $85^\circ\text{C}$ , typical values are at  $T_A = 25^\circ\text{C}$  battery charger specifications are valid in the range  $0^\circ\text{C} < T_A < 85^\circ\text{C}$  unless otherwise noted

PARAMETER		TEST CONDITIONS	MIN	TYP	MAX	UNIT		
<b>VCORE STEP-DOWN CONVERTER</b>								
$V_I$	Input voltage range		2.5		6.0	V		
$I_O$	Maximum output current		400			mA		
$I_{O(SD)}$	Shutdown supply current	BATT_COVER = GND		0.1	1	$\mu\text{A}$		
$r_{DS(on)}$	P-channel MOSFET on-resistance	$V_{I(CORE)} = V_{GS} = 3.6\text{ V}$		275	530	$\text{m}\Omega$		
$I_{lkg(p)}$	P-channel leakage current	$V_{DS} = 6.0\text{ V}$		0.1	1	$\mu\text{A}$		
$r_{DS(on)}$	N-channel MOSFET on-resistance	$V_{I(CORE)} = V_{GS} = 3.6\text{ V}$		275	500	$\text{m}\Omega$		
$I_{lkg(N)}$	N-channel leakage current	$V_{DS} = 6.0\text{ V}$		0.1	1	$\mu\text{A}$		
$I_L$	P-channel current limit	$2.5\text{ V} < V_{I(CORE)} < 6.0\text{ V}$	600	700	900	mA		
$f_S$	Oscillator frequency		1	1.25	1.5	MHz		
$V_{O(CORE)}$	Fixed output voltage	0.85 V	$V_{I(CORE)} = 2.5\text{ V}$ to $6.0\text{ V}$ ; $I_O = 0\text{ mA}$ , $C_O = 22\text{ }\mu\text{F}$		0%	3%		
			$V_{I(CORE)} = 2.5\text{ V}$ to $6.0\text{ V}$ ; $0\text{ mA} \leq I_O \leq 400\text{ mA}$ , $C_O = 22\text{ }\mu\text{F}$		3%	3%		
		1.0 V	$V_{I(CORE)} = 2.5\text{ V}$ to $6.0\text{ V}$ ; $I_O = 0\text{ mA}$ , $C_O = 22\text{ }\mu\text{F}$		0%	3%		
			$V_{I(CORE)} = 2.5\text{ V}$ to $6.0\text{ V}$ ; $0\text{ mA} \leq I_O \leq 400\text{ mA}$ , $C_O = 22\text{ }\mu\text{F}$		3%	3%		
		1.1 V	$V_{I(CORE)} = 2.5\text{ V}$ to $6.0\text{ V}$ ; $I_O = 0\text{ mA}$ , $C_O = 22\text{ }\mu\text{F}$		0%	3%		
			$V_{I(CORE)} = 2.5\text{ V}$ to $6.0\text{ V}$ ; $0\text{ mA} \leq I_O \leq 400\text{ mA}$ , $C_O = 22\text{ }\mu\text{F}$		3%	3%		
		1.2 V	$V_{I(CORE)} = 2.5\text{ V}$ to $6.0\text{ V}$ ; $I_O = 0\text{ mA}$		0%	3%		
			$V_{I(CORE)} = 2.5\text{ V}$ to $6.0\text{ V}$ ; $0\text{ mA} \leq I_O \leq 400\text{ mA}$		3%	3%		
		1.3 V	$V_{I(CORE)} = 2.5\text{ V}$ to $6.0\text{ V}$ ; $I_O = 0\text{ mA}$		0%	3%		
			$V_{I(CORE)} = 2.5\text{ V}$ to $6.0\text{ V}$ ; $0\text{ mA} \leq I_O \leq 400\text{ mA}$		3%	3%		
		1.4 V	$V_{I(CORE)} = 2.5\text{ V}$ to $6.0\text{ V}$ ; $I_O = 0\text{ mA}$		0%	3%		
			$V_{I(CORE)} = 2.5\text{ V}$ to $6.0\text{ V}$ ; $0\text{ mA} \leq I_O \leq 400\text{ mA}$		3%	3%		
		1.5 V	$V_{I(CORE)} = 2.5\text{ V}$ to $6.0\text{ V}$ ; $I_O = 0\text{ mA}$		0%	3%		
			$V_{I(CORE)} = 2.5\text{ V}$ to $6.0\text{ V}$ ; $0\text{ mA} \leq I_O \leq 400\text{ mA}$		3%	3%		
		1.6 V	$V_{I(CORE)} = 2.5\text{ V}$ to $6.0\text{ V}$ ; $I_O = 0\text{ mA}$		0%	3%		
			$V_{I(CORE)} = 2.5\text{ V}$ to $6.0\text{ V}$ ; $0\text{ mA} \leq I_O \leq 400\text{ mA}$		3%	3%		
		Line regulation		$V_{I(CORE)} = V_{O(MAIN)} + 0.5\text{ V}$ (min. 2.5 V) to $6.00\text{ V}$ , $I_O = 10\text{ mA}$		1		%/V
		Load regulation		$I_O = 10\text{ mA}$ to $400\text{ mA}$		0.002		%/mA
$R_{(VCORE)}$	VCORE discharge resistance			400		$\Omega$		
<b>VLDO1 and VLDO2 LOW-DROPOUT REGULATORS</b>								
$V_I$	Input voltage range		1.8		6.5	V		
$V_O$	LDO1 output voltage range		0.9	VINLDO1		V		
$V_{ref}$	Reference voltage		485	500	515	mV		
$V_O$	LDO2 output voltage range		1.8		3.0	V		
$I_O$	Maximum output current	Full-power mode	200			mA		
		Low-power mode	30					
$I_{(SC)}$	LDO1 & LDO2 short-circuit current limit	VLDO1 = GND, VLDO2 = GND			650	mA		
	Dropout voltage	$I_O = 200\text{ mA}$ , VINLDO1,2 = 1.8 V			300	mV		
	Total accuracy				$\pm 3\%$			
	Line regulation	VINLDO1,2 = VLDO1,2 + 0.5 V (min. 2.5 V) to $6.5\text{ V}$ , $I_O = 10\text{ mA}$		0.75		%/V		

**ELECTRICAL CHARACTERISTICS (continued)**

$V_{I(MAIN)} = V_{I(CORE)} = V_{CC} = V_{I(LDO1)} = V_{I(LDO2)} = 3.6\text{ V}$ ,  $T_A = -40^\circ\text{C}$  to  $85^\circ\text{C}$ , typical values are at  $T_A = 25^\circ\text{C}$  battery charger specifications are valid in the range  $0^\circ\text{C} < T_A < 85^\circ\text{C}$  unless otherwise noted

PARAMETER	TEST CONDITIONS	MIN	TYP	MAX	UNIT
Load regulation	$I_O = 10\text{ mA}$ to $200\text{ mA}$		0.011		%/mA
Regulation time	Load change from 10% to 90%			0.1	ms
	Low-power mode		0.1		
$I_{(QFP)}$	LDO quiescent current (each LDO)		16	30	$\mu\text{A}$
$I_{(QLPM)}$	LDO quiescent current (each LDO)		12	18	$\mu\text{A}$
$I_{(SD)}$	LDO shutdown current (each LDO)		0.1	1	$\mu\text{A}$
$I_{(kg(FB))}$	Leakage current feedback		0.01	0.1	$\mu\text{A}$

**ELECTRICAL CHARACTERISTICS**

Battery Charger,  $V_{O(REG)} + V_{(DO-MAX)} \leq V_{(CHG)} = V_{(AC)}$  or  $V_{(USB)}$ ,  $I_{(TERM)} < I_O \leq 1\text{ A}$ ,  $0^\circ\text{C} < T_A < 85^\circ\text{C}$

PARAMETER	TEST CONDITIONS	MIN	TYP	MAX	UNIT	
$V_{(AC)}$	Input voltage range	4.5		5.5	V	
$V_{(USB)}$	Input voltage range	4.35		5.25	V	
$I_{CC(VCHG)}$	Supply current $V_{(CHG)} > V_{(CHG)min}$		1.2	2	mA	
$I_{CC(SLP)}$	Sleep current Sum of currents into VBAT pin, $V_{(CHG)} < V_{(SLP-ENTRY)}$ , $0^\circ\text{C} \leq T_J \leq 85^\circ\text{C}$		2	5	$\mu\text{A}$	
$I_{CC(STBY)}$	Standby current	Current into USB pin		45	$\mu\text{A}$	
		Current into AC pin	200	400		
<b>VOLTAGE REGULATOR</b>						
$V_O$	Output voltage $V_{(CHG)min} \geq 4.5\text{ V}$	4.15	4.20	4.25	V	
$V_{DO}$	Dropout voltage ( $V_{(AC)} - V_{BAT}$ ) $V_{O(REG)} + V_{(DO-MAX)} \leq V_{(CHG)}$ , $I_{O(OUT)} = 1\text{ A}$		500	800	mV	
	Dropout voltage ( $V_{(USB)} - V_{BAT}$ ) $V_{O(REG)} + V_{(DO-MAX)} \leq V_{(CHG)}$ , $I_{O(OUT)} = 0.5\text{ A}$		300	500		
	Dropout voltage ( $V_{(USB)} - V_{BAT}$ ) $V_{O(REG)} + V_{(DO-MAX)} \leq V_{(CHG)}$ , $I_{O(OUT)} = 0.1\text{ A}$		100	150		
<b>CURRENT REGULATION</b>						
$I_{O(AC)}$	Output current range for ac operation <sup>(1)</sup> $V_{CHG} \geq 4.5\text{ V}$ , $V_{I(OUT)} > V_{(LOWV)}$ , $V_{(AC)} - V_{I(BAT)} > V_{(DO-MAX)}$	100		1000	mA	
$V_{(SET)}$	Output current set voltage for ac operation at ISET pin. 100% output current I <sup>2</sup> C register CHGCONFIG<4:3> = 11		2.45	2.50	2.55	V
	75% output current I <sup>2</sup> C register CHGCONFIG<4:3> = 10	$V_{min} \geq 4.5\text{ V}$ , $V_{I(BAT)} > V_{(LOWV)}$ , $V_{(AC)} - V_{I(BAT)} > V_{(DO-MAX)}$	1.83	1.91	1.99	
	50% output current I <sup>2</sup> C register CHGCONFIG<4:3> = 01		1.23	1.31	1.39	
	32% output current I <sup>2</sup> C register CHGCONFIG<4:3> = 00		0.76	0.81	0.86	
KSET	Output current set factor for ac operation	$100\text{ mA} < I_O < 1000\text{ mA}$	310	330	350	mA
		$10\text{ mA} < I_O < 100\text{ mA}$	300	340	380	
$I_{O(USB)}$	Output current range for USB operation	$V_{(CHG)min} \geq 4.35\text{ V}$ , $V_{I(BAT)} > V_{(LOWV)}$ , $V_{(USB)} - V_{I(BAT)} > V_{(DO-MAX)}$ , I <sup>2</sup> C register CHGCONFIG<2> = 0	80		100	mA
		$V_{(CHG)min} \geq 4.5\text{ V}$ , $V_{I(BAT)} > V_{(LOWV)}$ , $V_{(USB)} - V_{I(BAT)} > V_{(DO-MAX)}$ , I <sup>2</sup> C register CHGCONFIG<2> = 1	400		500	
$R_{(ISET)}$	Resistor range at ISET pin		825	8250	$\Omega$	

$$(1) I_{O(AC)} = \frac{KSET \times V_{(SET)}}{R_{(ISET)}}$$

**ELECTRICAL CHARACTERISTICS (continued)**

Battery Charger,  $V_{O(REG)} + V_{(DO-MAX)} \leq V_{(CHG)} = V_{(AC)}$  or  $V_{(USB)}$ ;  $I_{(TERM)} < I_{O} \leq 1 \text{ A}$ ,  $0^\circ\text{C} < T_A < 85^\circ\text{C}$

PARAMETER	TEST CONDITIONS	MIN	TYP	MAX	UNIT	
<b>PRECHARGE CURRENT REGULATION, SHORT-CIRCUIT CURRENT, AND BATTERY DETECTION CURRENT</b>						
$V_{(LOWV)}$	Precharge to fast-charge transition threshold, voltage on VBAT pin.	$V_{(CHG)min} \geq 4.5V$	2.8	3.0	3.2	V
	Deglintch time	$V_{(CHG)min} \geq 4.5 \text{ V}$ , $V_{(I(OUT))}$ decreasing below threshold; 100-ns fall time, 10-mV overdrive	250	375	500	ms
$I_{(PRECHG)}$	Precharge current <sup>(2)</sup>	$0 \leq V_{(I(OUT))} < V_{(LOWV)}$ , $t < t_{(PRECHG)}$	10		100	mA
$I_{(DETECT)}$	Battery detection current		200			$\mu\text{A}$
$V_{(SET-PRECHG)}$	Voltage at ISET pin	$0 \leq V_{(I(OUT))} < V_{(LOWV)}$ , $t < t_{(PRECHG)}$	240	255	270	mV
<b>CHARGE TAPER AND TERMINATION DETECTION</b>						
$I_{(TAPER)}$	Taper current detect range <sup>(3)</sup>	$V_{(I(OUT))} > V_{(RCH)}$ , $t < t_{(TAPER)}$	10		100	mA
$V_{(SET\_TAPER)}$	Voltage at ISET pin for charge TAPER detection	$V_{(I(OUT))} > V_{(RCH)}$ , $t < t_{(TAPER)}$	235	250	265	mV
$V_{(SET\_TERM)}$	Voltage at ISET pin for charger termination detection <sup>(4)</sup>	$V_{(I(OUT))} > V_{(RCH)}$	11	18	25	mV
	Deglintch time for $I_{(TAPER)}$	$V_{(CHG)min} \geq 4.5V$ , charging current increasing or decreasing above and below; 100-ns fall time, 10-mV overdrive	250	375	500	ms
	Deglintch time for $I_{(TERM)}$	$V_{(CHG)min} \geq 4.5 \text{ V}$ , charging current decreasing below; 100-ns fall time, 10-mV overdrive	250	375	500	ms
<b>TEMPERATURE COMPARATOR</b>						
$V_{(LTF)}$	Low (cold) temperature threshold		2.475	2.50	2.525	V
$V_{(HTF)}$	High (hot) temperature threshold		0.485	0.5	0.515	V
$I_{(TS)}$	TS current source		95	102	110	$\mu\text{A}$
	Deglintch time for temperature fault		250	375	500	ms
<b>BATTERY RECHARGE THRESHOLD</b>						
$V_{(RCH)}$	Recharge threshold	$V_{(CHG)min} \geq 4.5 \text{ V}$	$V_{O(REG)} - 0.115$	$V_{O(REG)} - 0.1$	$V_{O(REG)} - 0.085$	V
	Deglintch time	$V_{(CHG)min} \geq 4.5 \text{ V}$ , $V_{(I(OUT))}$ decreasing below threshold; 100 ns fall time, 10 mV overdrive	250	375	500	ms
<b>TIMERS</b>						
$t_{(PRECHG)}$	Precharge timer	$V_{(CHG)min} \geq 4.5 \text{ V}$	1500	1800	2160	sec
$t_{(TAPER)}$	Taper timer	$V_{(CHG)min} \geq 4.5 \text{ V}$	1500	1800	2160	sec
$t_{(CHG)}$	Charge timer	$V_{(CHG)min} \geq 4.5 \text{ V}$	15000	18000	21600	sec
<b>SLEEP AND STANDBY</b>						
$V_{(SLP\_ENTRY)}$	Sleep-mode entry threshold, $\overline{\text{PG}}$ output = high	$2.3 \text{ V} \leq V_{(I(OUT))} \leq V_{O(REG)}$			$V_{(CHG)} \leq V_{(I(OUT))} + 150 \text{ mV}$	V
$V_{(SLP\_EXIT)}$	Sleep-mode exit threshold, $\overline{\text{PG}}$ output = low	$2.3 \text{ V} \leq V_{(I(OUT))} \leq V_{O(REG)}$			$V_{(CHG)} \geq V_{(I(OUT))} + 190 \text{ mV}$	V
	Deglintch time for sleep mode entry and exit	AC or USB decreasing below threshold; 100-ns fall time, 10-mV overdrive	200	375	500	ms
$t_{(USB\_DEL)}$	Delay between valid USB voltage being applied and start of charging process from USB			375		ms

$$(2) \quad I_{(PRECHG)} = \frac{KSET \times V_{(SET\_PRECHG)}}{R_{(ISET)}}$$

$$(3) \quad I_{(TAPER)} = \frac{KSET \times V_{(SET\_TAPER)}}{R_{(ISET)}}$$

$$(4) \quad I_{(TERM)} = \frac{KSET \times V_{(SET\_TERM)}}{R_{(ISET)}}$$

**ELECTRICAL CHARACTERISTICS (continued)**
 Battery Charger,  $V_{O(REG)} + V_{(DO-MAX)} \leq V_{(CHG)} = V_{(AC)}$  or  $V_{(USB)}$ ,  $I_{(TERM)} < I_O \leq 1 \text{ A}$ ,  $0^\circ\text{C} < T_A < 85^\circ\text{C}$ 

PARAMETER		TEST CONDITIONS	MIN	TYP	MAX	UNIT
<b>CHARGER POWER-ON-RESET, UVLO, AND <math>V_{(IN)}</math> RAMP RATE</b>						
$V_{(CHGUVLO)}$	Charger undervoltage lockout	$V_{(CHG)}$ decreasing	2.27	2.5	2.75	V
	Hysteresis			27		mV
$V_{(CHGOVLO)}$	Charger overvoltage lockout	$V_{(AC)}$ increasing		6.6		V
	Hysteresis				0.5	V
<b>CHARGER OVERTEMPERATURE SUSPEND</b>						
$T_{(suspend)}$	Temperature at which charger suspends operation			145		$^\circ\text{C}$
$T_{(hyst)}$	Hysteresis of suspend threshold			20		$^\circ\text{C}$
<b>LOGIC SIGNALS DEFMAIN, DEFCORE, PS_SEQ, IFLSB</b>						
$V_{IH}$	High level input voltage	$I_{IH} = 20 \mu\text{A}$	$V_{CC}-0.5$		$V_{CC}$	V
$V_{IL}$	Low level input voltage	$I_{IL} = 10 \mu\text{A}$	0		0.4	V
$I_{IB}$	Input bias current			0.01	1.0	$\mu\text{A}$
<b>LOGIC SIGNALS GPIO1-4</b>						
$V_{OL}$	Low level output voltage	$I_{OL} = 1 \text{ mA}$ , configured as an open drain output			0.3	V
$V_{OH}$	High level output voltage	Configured as an open drain output			6	V
$V_{IL}$	Low level input voltage		0		0.8	V
$V_{IH}$	High level input voltage		2		$V_{CC}^{(5)}$	V
$I_I$	Input leakage current				1	$\mu\text{A}$
$r_{DS(on)}$	Internal NMOS	$V_{OL} = 0.3 \text{ V}$		150		$\Omega$
<b>LOGIC SIGNALS <math>\overline{\text{PG}}</math>, LED2</b>						
$V_{OL}$	Low level output voltage	$I_{OL} = 20 \text{ mA}$			0.5	V
$V_{OH}$	High level output voltage				6	V
<b>VIBRATOR DRIVER VIB</b>						
$V_{OL}$	Low level output voltage	$I_{OL} = 100 \text{ mA}$		0.3	0.5	V
$V_{OH}$	High level output voltage				6	V
<b>THERMAL SHUTDOWN</b>						
$T_{(SD)}$	Thermal shutdown	Increasing junction temperature		160		$^\circ\text{C}$
<b>UNDervoltage LOCK OUT</b>						
$V_{(UVLO)}$	Undervoltage lockout threshold	$V_{(UVLO)} 2.5 \text{ V}$	Filter resistor = 10R in series with $V_{CC}$ , $V_{CC}$ decreasing	-3%	3%	
		$V_{(UVLO)} 2.75 \text{ V}$		-3%	3%	
		$V_{(UVLO)} 3.0 \text{ V}$		-3%	3%	
		Default value		$V_{(UVLO)} 3.25 \text{ V}$	-3%	3%
$V_{(UVLO\_HYST)}$	UVLO comparator hysteresis	$V_{CC}$ rising	150		200	mV
<b>POWER GOOD</b>						
		$V_{MAIN}$ , $V_{CORE}$ , $V_{LDO1}$ , $V_{LDO2}$ decreasing	-12%	-10%	-8%	
		$V_{MAIN}$ , $V_{CORE}$ , $V_{LDO1}$ , $V_{LDO2}$ increasing	-7%	-5%	-3%	

(5) If the input voltage is higher than  $V_{CC}$  an additional current, limited by an internal 10-k $\Omega$  resistor, flows.

**SERIAL INTERFACE TIMING REQUIREMENTS**

	<b>MIN</b>	<b>MAX</b>	<b>UNIT</b>
Clock frequency, $f_{MAX}$		400	kHz
Clock high time, $t_{WH(HIGH)}$	600		ns
Clock low time, $t_{WL(LOW)}$	1300		ns
DATA and CLK rise time, $t_R$		300	ns
DATA and CLK fall time, $t_F$		300	ns
Hold time (repeated) START condition (after this period the first clock pulse is generated), $t_{h(STA)}$	600		ns
Setup time for repeated START condition, $t_{h(DATA)}$	600		ns
Data input hold time, $t_{h(DATA)}$	0		ns
Data input setup time, $t_{su(DATA)}$	100		ns
STOP condition setup time, $t_{su(STO)}$	600		ns
Bus free time, $t_{(BUF)}$	1300		ns

**PIN ASSIGNMENTS**

**RGZ PACKAGE  
(TOP VIEW)**

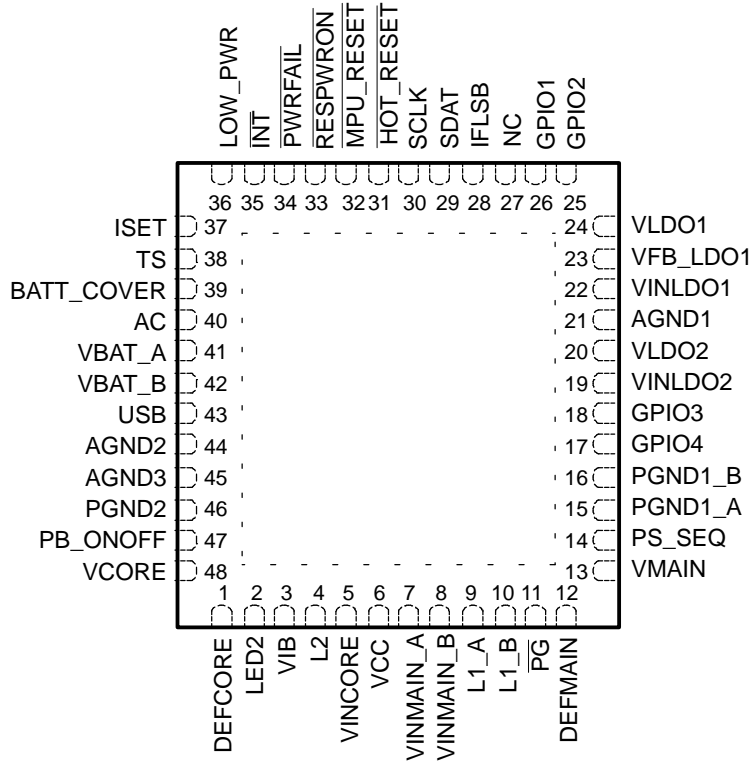

NC - No internal connection

**PIN ASSIGNMENTS (continued)****Terminal Functions**

TERMINAL NAME	NO.	I/O	DESCRIPTION
<b>CHARGER SECTION</b>			
AC	40	I	Charger input voltage from ac adapter. The AC pin can be left open or can be connected to ground if the charger is not used.
USB	43	I	Charger input voltage from USB port. The USB pin can be left open or can be connected to ground if the charger is not used.
ISET	37	I	External charge current setting resistor connection for use with ac adapter
VBAT_A	41	I	Sense input for the battery voltage. Connect directly with the battery.
VBAT_B	42	O	Power output of the battery charger. Connect directly with the battery.
TS	38	I	Battery temperature sense input
$\overline{\text{PG}}$	11	O	Indicates when a valid power supply is present for the charger (open drain)
AGND2	44		Analog ground connection. All analog ground pins are connected internally on the chip.
NC	27		Connect this pin to GND.
PowerPAD™	-		Connect the PowerPAD to GND
<b>SWITCHING REGULATOR SECTION</b>			
AGND3	45		Analog ground connection. All analog ground pins are connected internally on the chip.
VINMAIN_A, VINMAIN_B	7,8	I	Input voltage for VMAIN step-down converter. This must be connected to the same voltage supply as VINCORE and VCC.
L1_A, L1_B	9,10		Switch pin of VMAIN converter. The VMAIN inductor is connected here.
VMAIN	13	I	VMAIN feedback voltage sense input, connect directly to VMAIN
VCC	6	I	Power supply for digital and analog circuitry of MAIN and CORE dc-dc converters. This must be connected to the same voltage supply as VINCORE and VINMAIN. Also supplies serial interface block
PGND1_A, PGND1_B	15,16		Power ground for VMAIN converter
VINCORE	5	I	Input voltage for VCORE step-down converter. This must be connected to the same voltage supply as VINMAIN and VCC.
L2	4		Switch pin of VCORE converter. The VCORE inductor is connected here.
VCORE	48	I	VCORE feedback voltage sense input, connect directly to VCORE
PGND2	46		Power ground for VCORE converter
<b>LDO REGULATOR SECTION</b>			
AGND1	21		Analog ground connection. All analog ground pins are connected internally on the chip.
VINLDO1	22	I	Input voltage for LDO1
VLDO1	24	O	Output voltage for LDO1
VFB_LDO1	23	I	Feedback input from external resistive divider for LDO1
VINLDO2	19	I	Input voltage for LDO2
VLDO2	20	O	Output and feedback voltage for LDO2
<b>DRIVER SECTION</b>			
LED2	2	O	LED driver, with blink rate programmable via serial interface
VIB	3	O	Vibrator driver, enabled via serial interface
<b>CONTROL AND I2C SECTION</b>			
PS_SEQ	14	I	Sets power-up/down sequence of step-down converters
PB_ONOFF	47	I	Push button enable pin, also used to wake-up processor from <i>low power mode</i>
BATT_COVER	39	I	Indicates if battery cover is in place
$\overline{\text{HOT\_RESET}}$	31	I	Push button reset input used to reboot or wake-up processor via TPS65010
$\overline{\text{MPU\_RESET}}$	32	O	Open drain reset output generated by user activated $\overline{\text{HOT\_RESET}}$
$\overline{\text{RESPWRON}}$	33	O	Open drain system reset output, generated according to the state of the LDO1 output voltage

**PIN ASSIGNMENTS (continued)**
**Terminal Functions (continued)**

TERMINAL NAME	NO.	I/O	DESCRIPTION
<b>CHARGER SECTION</b>			
PWRFAIL	34	O	Open drain output. Active low when UVLO comparator indicates low VBAT condition or when shutdown is about to occur due to an overtemperature condition or when the battery cover is removed (BATT_COVER has gone low).
INT	35	O	Indicates a charge fault or termination, or if any of the regulator outputs are below the lower tolerance level, active low (open drain)
LOW_PWR	36	I	Input signal indicating deep sleep mode, V <sub>CORE</sub> is lowered to predefined value or disabled
DEFMAIN	12	I	Input signal indicating default V <sub>MAIN</sub> voltage, 0 = 3.0 V, 1 = 3.3 V
DEFCORE	1	I	Input signal indicating default V <sub>CORE</sub> voltage, 0 = 1.5 V, 1 = 1.6 V
SCLK	30	I	Serial interface clock line
SDAT	29	I/O	Serial interface data/address
IFLSB	28	I	LSB of serial interface address used to distinguish two devices with the same address
GPIO1	26	I/O	General-purpose open-drain input/output
GPIO2	25	I/O	General-purpose open-drain input/output
GPIO3	18	I/O	General-purpose open-drain input/output
GPIO4	17	I/O	General-purpose open-drain input/output

FUNCTIONAL BLOCK DIAGRAM

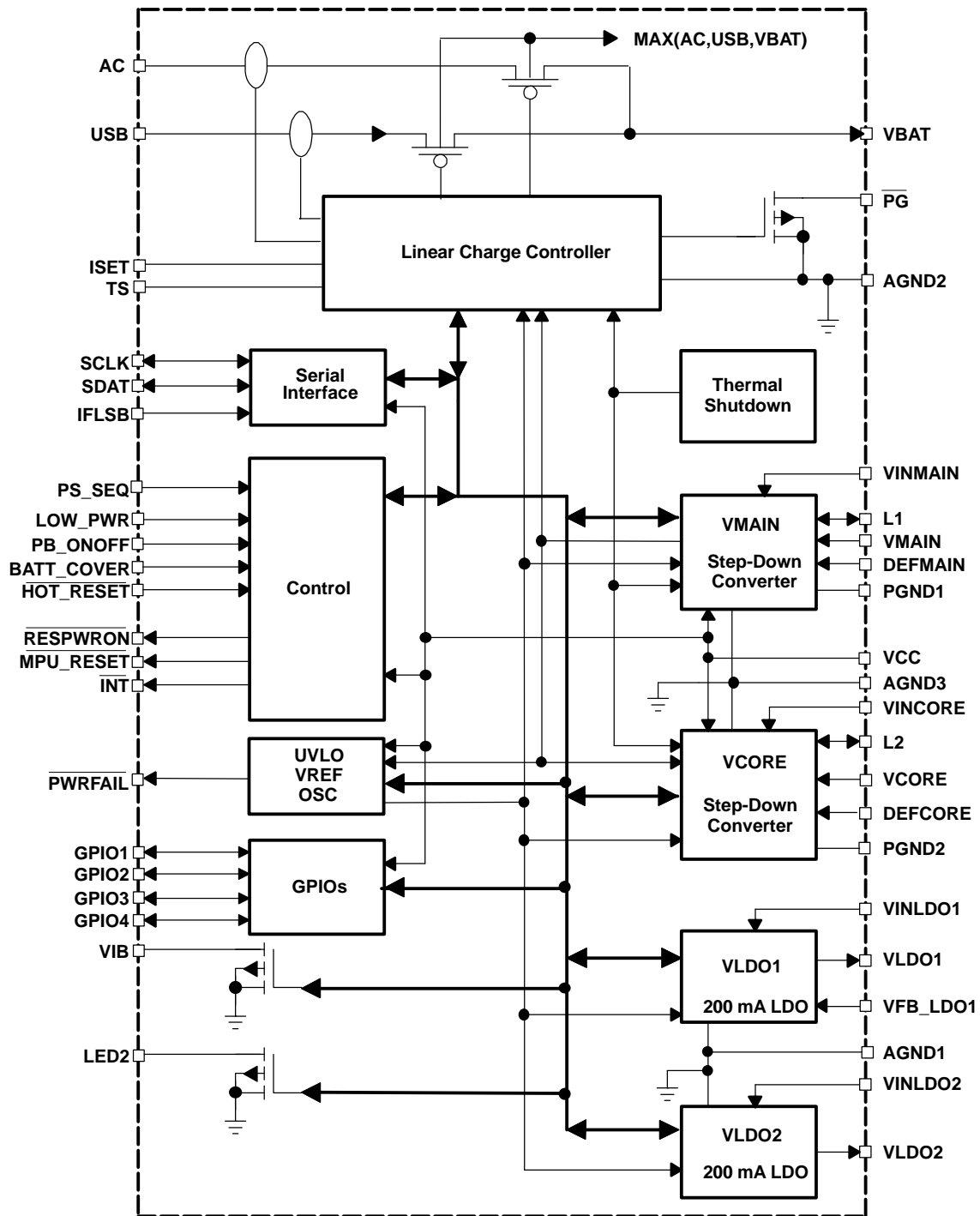

**TYPICAL CHARACTERISTICS**

**Table of Graphs**

		<b>FIGURE</b>
Efficiency	vs Output current	1-4
Quiescent current	vs Input voltage	5
Switching frequency	vs Temperature	6
Output voltage	vs Output current	7, 8
LDO1 Output voltage	vs Output current	9
LDO2 Output voltage	vs Output current	10
Line transient response (main)		11
Line transient response (core)		12
Line transient response (LDO1)		13
Line transient response (LDO2)		14
Load transient response (main)		15
Load transient response (core)		16
Load transient response (LDO1)		17
Load transient response (LDO2)		18
Output Voltage Ripple (PFM)		19
Output Voltage Ripple (PWM)		20
Startup timing		21
Dropout voltage	vs Output current	22, 23
PSRR (LDO1 and LDO2)	vs Frequency	24

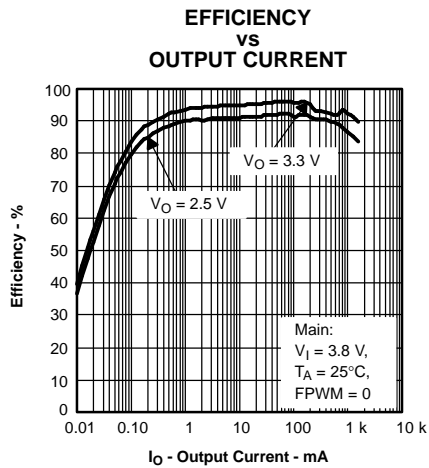

**Figure 1.**

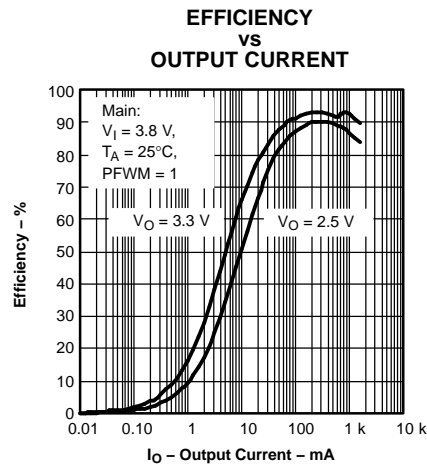

**Figure 2.**

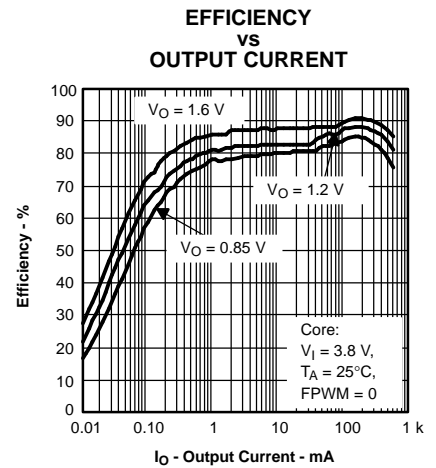

**Figure 3.**

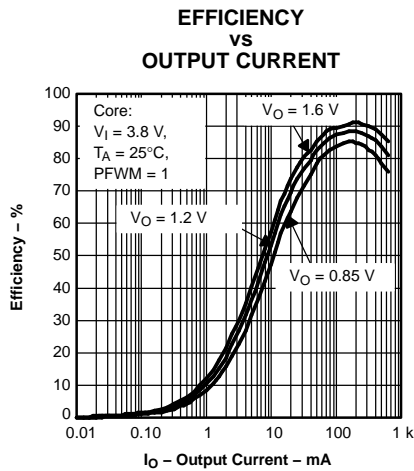

Figure 4.

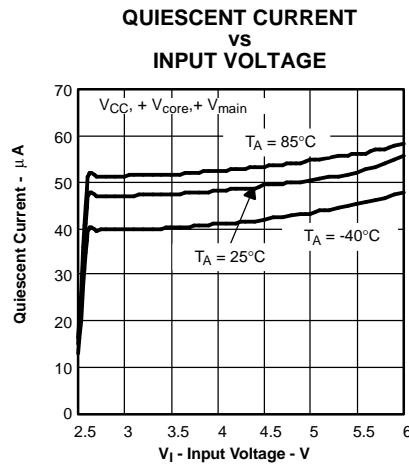

Figure 5.

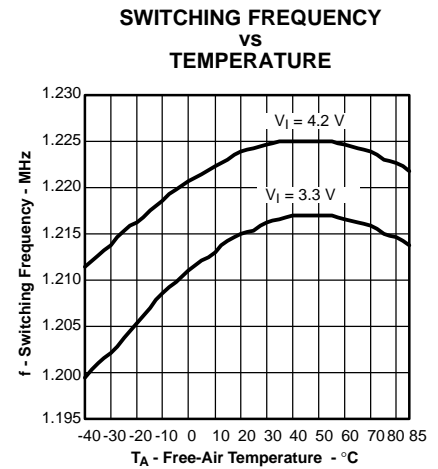

Figure 6.

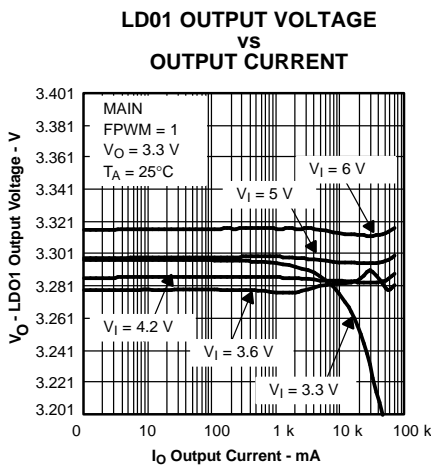

Figure 7.

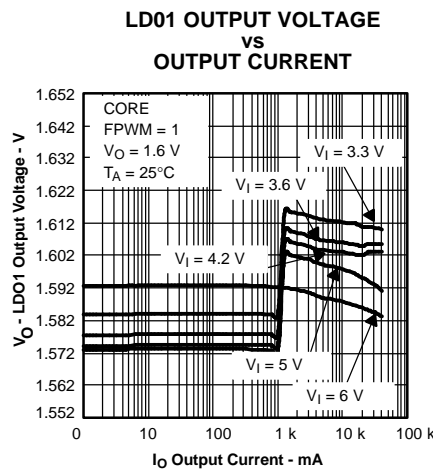

Figure 8.

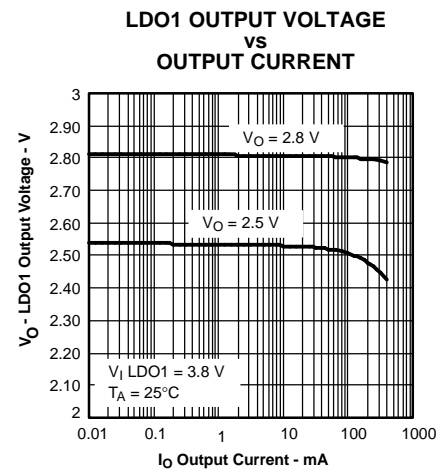

Figure 9.

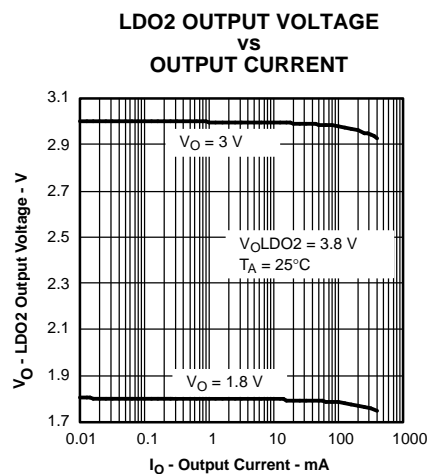

Figure 10.

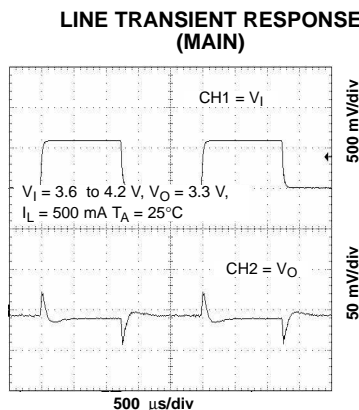

Figure 11.

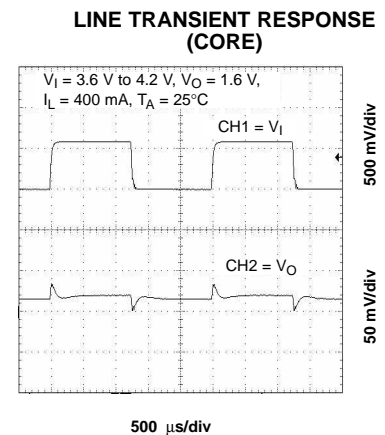

Figure 12.

LINE TRANSIENT RESPONSE  
(LDO1)

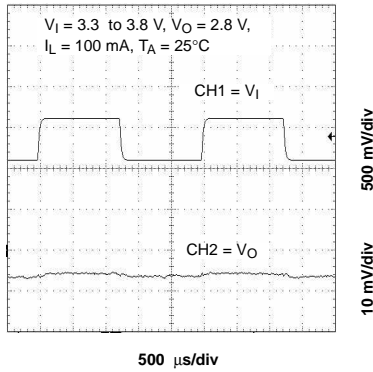

Figure 13.

LINE TRANSIENT RESPONSE  
(LDO2)

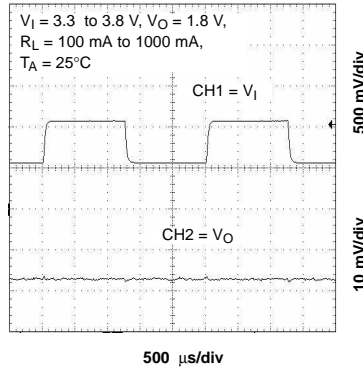

Figure 14.

LINE TRANSIENT RESPONSE  
(CORE)

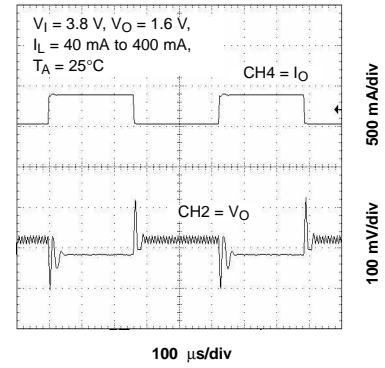

Figure 15.

LINE TRANSIENT RESPONSE  
(MAIN)

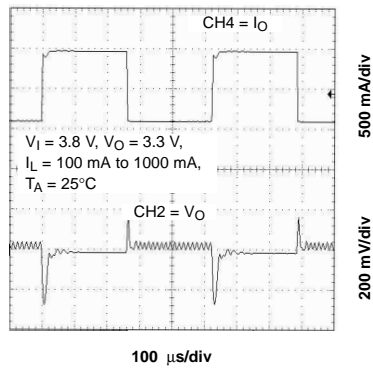

Figure 16.

LINE TRANSIENT RESPONSE  
(LDO1)

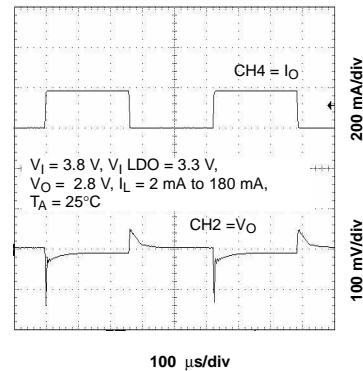

Figure 17.

LINE TRANSIENT RESPONSE  
(LDO2)

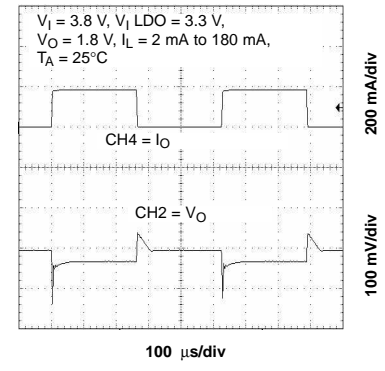

Figure 18.

OUTPUT RIPPLE (PFM)

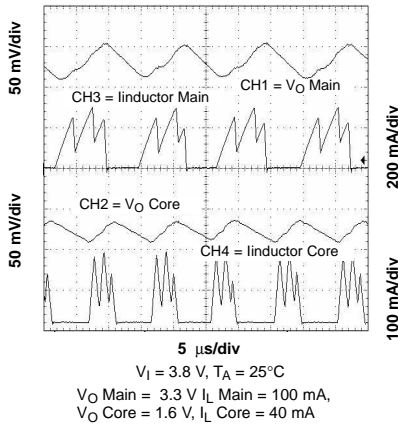

Figure 19.

OUTPUT RIPPLE (PWM)

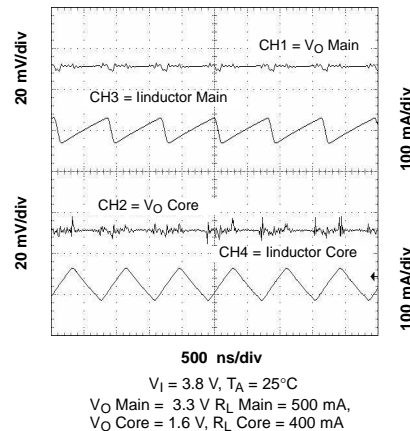

Figure 20.

STARTUP TIMING

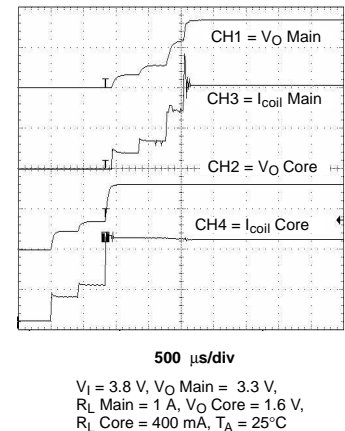

Figure 21.

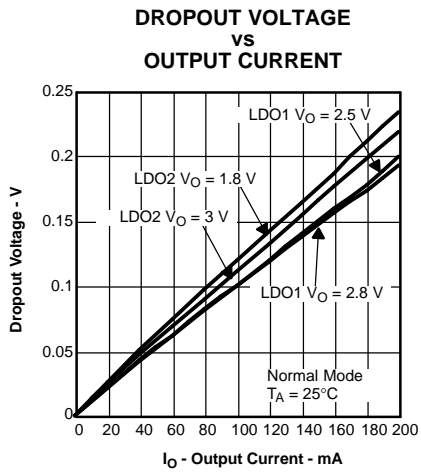

Figure 22.

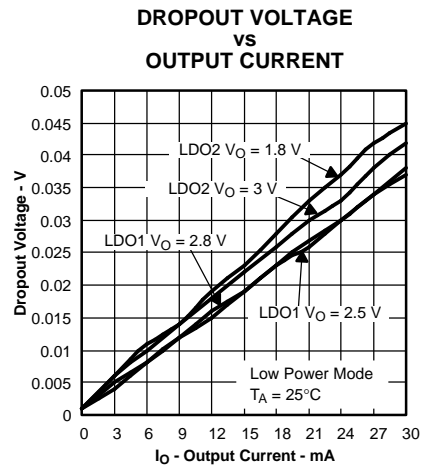

Figure 23.

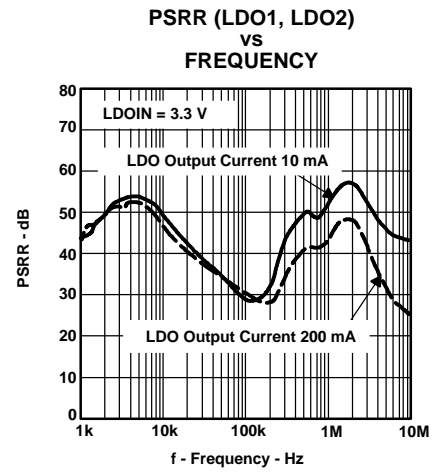

Figure 24.

APPLICATION INFORMATION

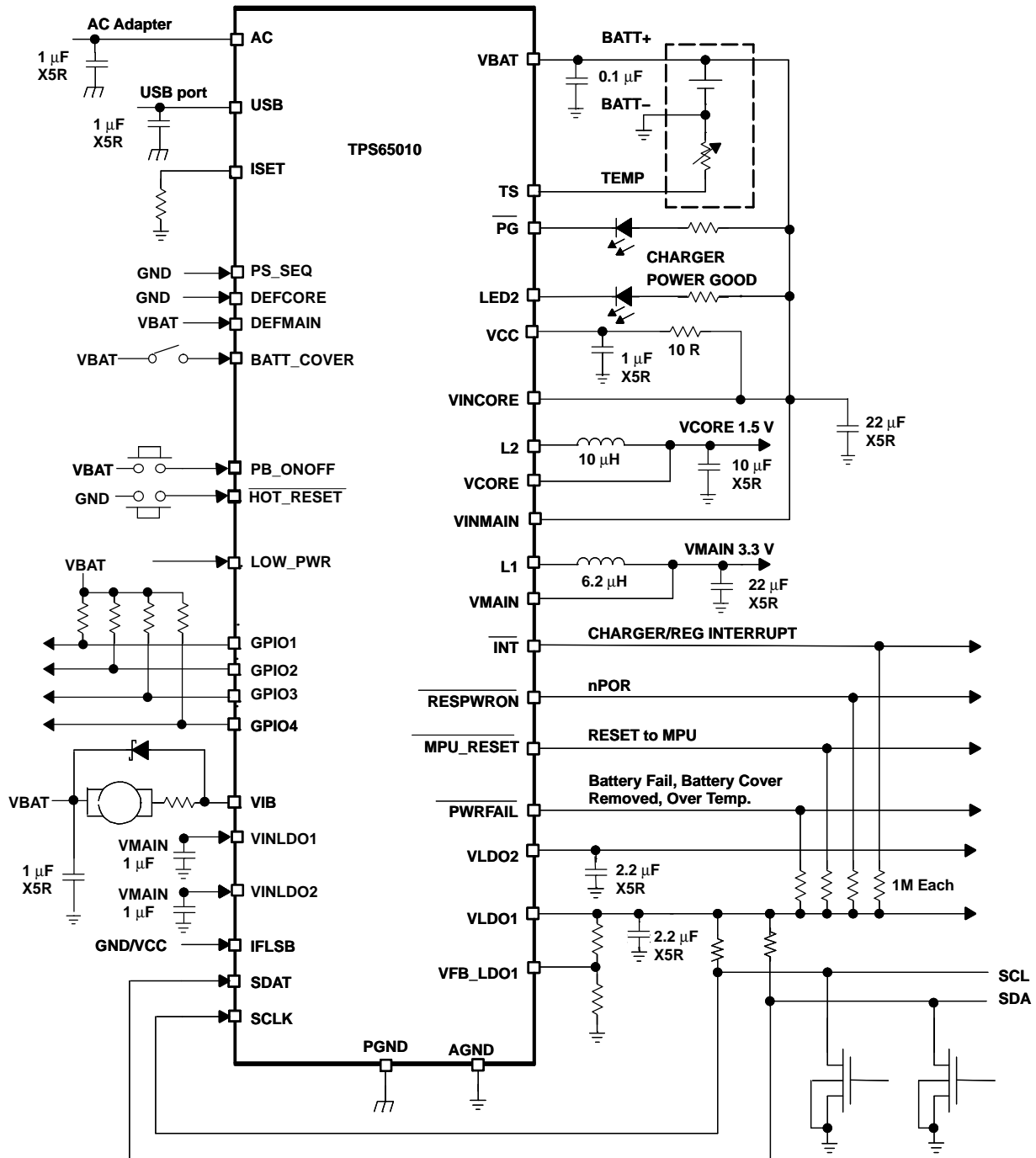

Figure 25. Typical Application Circuit

The VCORE and VMAIN converter are always enabled in a typical application. The VCORE output voltage can be disabled or reduced from 1.5 V to a lower, preset voltage under processor control. When the processor enters the sleep mode, a high signal on the LOW\_PWR pin initiates the change

VCORE typically supplies the digital part of the audio codec. When the processor is in sleep or low power mode, the audio codec is powered off, so the VCORE voltage can be programmed to lower voltages without a problem. A typical audio codec (e.g., TI AIC23) consumes about 20-mA to 30-mA current from the VCORE power supply.

**APPLICATION INFORMATION (continued)**

It is recommended to supply LDO1 from VMAIN as shown in Figure 25. If this is not done, then subsequent to a UVLO, OVERTEMP, or BATT\_COVER = 0 condition, the  $\overline{\text{RESPWRON}}$  signal goes high before the VCORE rail has ramped and stabilized. Therefore, the processor core does not receive a power on reset signal.

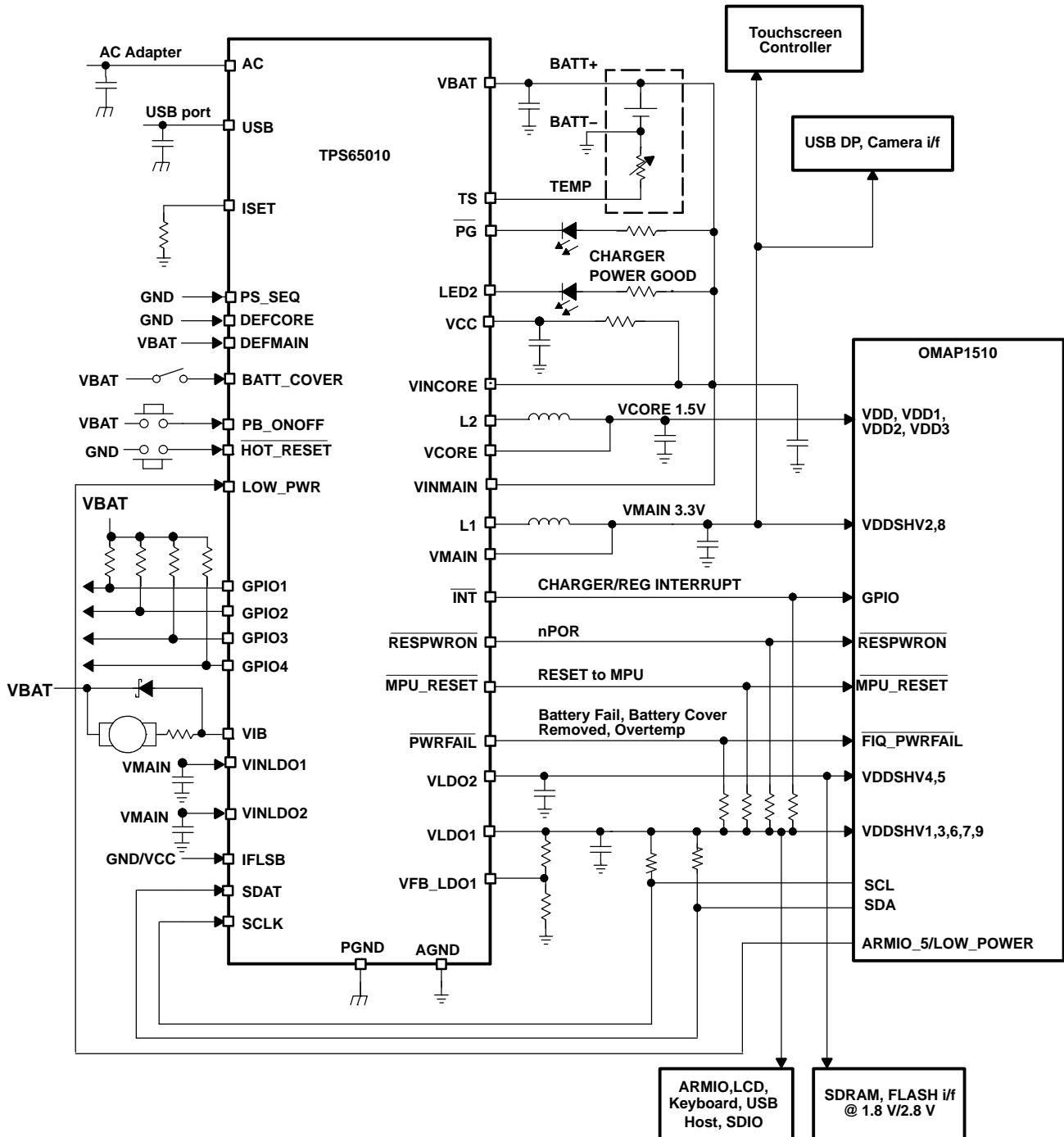

**Figure 26. Typical Application Circuit in Low Power Mode**

## DETAILED DESCRIPTION

### BATTERY CHARGER

The TPS65010 supports a precision Li-Ion or Li-Polymer charging system suitable for single-cells with either coke or graphite anodes. Charging the battery is possible even without the application processor being powered up. The TPS65010 starts charging when an input voltage on either ac or USB input is present, which is greater than the charger UVLO threshold. See Figure 27 for a typical charge profile.

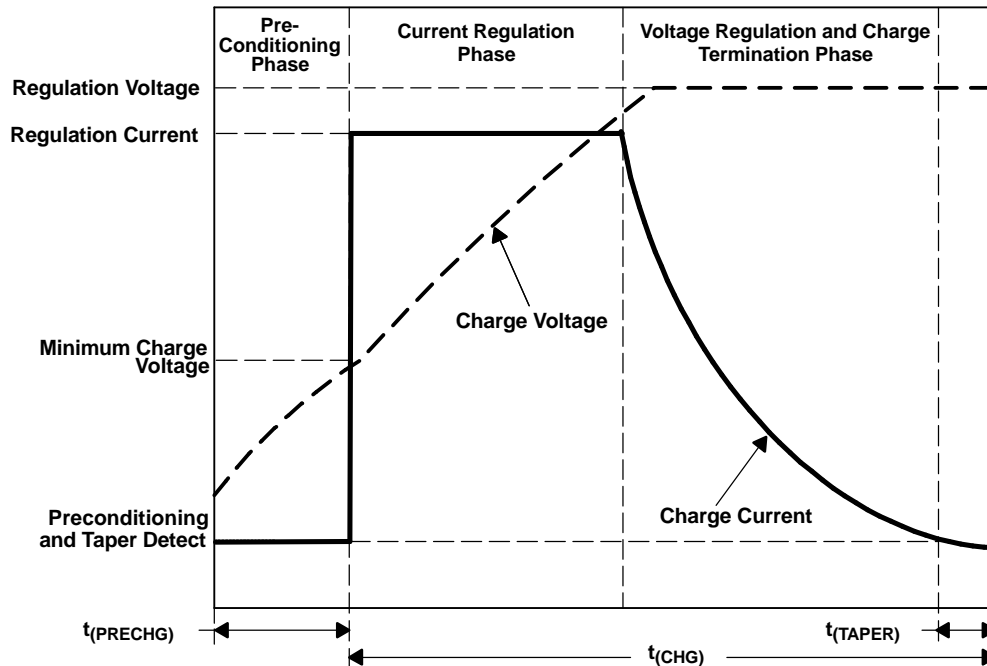

Figure 27. Typical Charging Profile

### Autonomous Power Source Selection

Per default the TPS65010 attempts to charge from the ac input. If ac input is not present, the USB is selected. If both inputs are available, the ac input has priority. The charge current is initially limited to 100 mA when charging from the USB input. This can be increased to 500 mA via the serial interface. The charger can be completely disabled via the interface, and it is also possible just to disable charging from the USB port. The start of the charging process from the USB port is delayed in order to allow the application processor time to disable USB charging, for instance if a USB OTG port is recognized. The recommended input voltage for charging from the ac input is  $4.5\text{ V} < V_{AC} < 5.5\text{ V}$ . However, the TPS65010 is capable of withstanding (but not charging from) up to 20 V. Charging is disabled if  $V_{AC}$  is greater than typically 6.6 V.

### Temperature Qualification

The TPS65010 continuously monitors battery temperature by measuring the voltage between the TS and AGND pins. An internal current source provides the bias for most common 10K negative-temperature coefficient thermistors (NTC) (see Figure 28). The IC compares the voltage on the TS pin against the internal  $V_{(LTF)}$  and  $V_{(HTF)}$  thresholds to determine if charging is allowed. Once a temperature outside the  $V_{(LTF)}$  and  $V_{(HTF)}$  thresholds is detected the IC immediately suspends the charge. The IC suspends charge by turning off the power FET and holding the timer value (i.e., timers are *not* reset). Charge is resumed when the temperature returns to the normal range.

The allowed temperature range for 103AT type thermistor is  $0^{\circ}\text{C}$  to  $45^{\circ}\text{C}$ . However the user may modify these thresholds by adding two external resistors. See Figure 29.

DETAILED DESCRIPTION (continued)

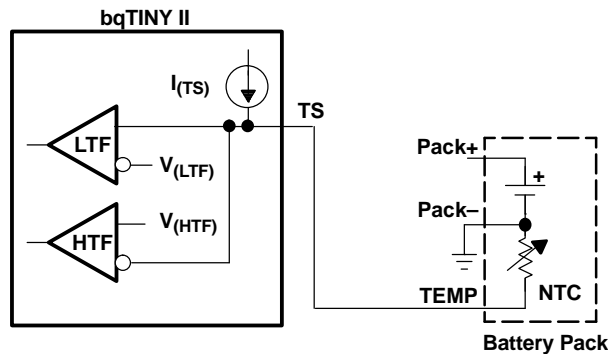

Figure 28. TS Pin Configuration

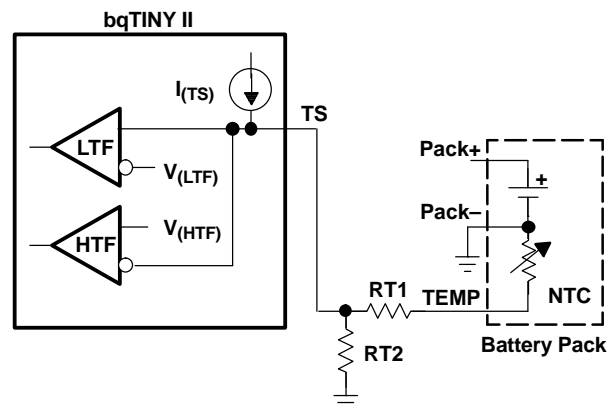

Figure 29. TS Pin Threshold

**Battery Preconditioning**

On power up, if the battery voltage is below the  $V_{(LOWV)}$  threshold, the TPS65010 applies a precharge current,  $I_{(PRECHG)}$ , to the battery. This feature revives deeply discharged cells. The charge current during this phase is one tenth of the value in current regulation phase which is set with  $I_{O(out)} = KSET \times V_{(SET)}/R_{(SET)}$ . The load current in preconditioning phase must be lower than  $I_{(PRECHG)}$  and must allow the battery voltage to rise above  $V_{(LOWV)}$  within  $t_{(PRECHG)}$ . VBAT\_A is the sense pin to the voltage comparator for the battery voltage. This allows a power on sense measurement if the VBAT\_A and VBAT\_B pins are connected together at the battery.

The TPS65010 activates a safety timer,  $t_{(PRECHG)}$ , during the conditioning phase. If  $V_{(LOWV)}$  threshold is not reached within the timer period, the TPS65010 turns off the charger and indicates the fault condition in the CHGSTATUS register. In the case of a fault condition, the TPS65010 reduces the current to  $I_{(DETECT)}$ .  $I_{(DETECT)}$  is used to detect a battery replacement condition. Fault condition is cleared by POR or battery replacement or via the serial interface.

**Battery Charge Current**

TPS65010 offers on-chip current regulation. When charging from an ac adapter, a resistor connected between the ISET1 and AGND pins determines the charge rate. A maximum of 1-A charger current from the ac adapter is allowed. When charging from a USB port either a 100-mA or 500-mA charge rate can be selected via the serial interface, default is 100 mA max. Two bits are available in the CHGCONFIG register in the serial interface to reduce the charge current in 25% steps. These only influence charging from the ac input and may be of use if charging is often suspended due to excessive junction temperature in the TPS65010 (e.g., at high ac input voltages) and low battery voltages.

## DETAILED DESCRIPTION (continued)

### Battery Voltage Regulation

The voltage regulation feedback is through the VBAT pin. This pin is tied directly to the positive side of the battery pack. The TPS65010 monitors the battery-pack voltage between the VBAT and AGND pins. The TPS65010 is offered in a fixed-voltage version of 4.2 V.

As a safety backup, the TPS65010 also monitors the charge time in the fast-charge mode. If taper current is not detected within this time period,  $t_{(CHG)}$ , the TPS65010 turns off the charger and indicates FAULT in the CHGSTATUS register. In the case of a FAULT condition, the TPS65010 reduces the current to  $I_{(DETECT)}$ .  $I_{(DETECT)}$  is used to detect a battery replacement condition. Fault condition is cleared by POR via the serial interface. Note that the safety timer is reset if the TPS65010 is forced out of the voltage regulation mode. The fast-charge timer is disabled by default to allow charging during normal operation of the end equipment. It is enabled via the CHGCONFIG register.

### Charge Termination and Recharge

The TPS65010 monitors the charging current during the voltage regulation phase. Once the taper threshold,  $I_{(TAPER)}$ , is detected the TPS65010 initiates the taper timer,  $t_{(TAPER)}$ . Charge is terminated after the timer expires. The TPS65010 resets the taper timer in the event that the charge current returns above the taper threshold,  $I_{(TAPER)}$ . After a charge termination, the TPS65010 restarts the charge once the voltage on the VBAT pin falls below the  $V_{(RCH)}$  threshold. This feature keeps the battery at full capacity at all times. The fast charge timer and the taper timer must be enabled by programming CHGCONFIG(5)=1. A thermal suspend will suspend the fast charge and taper timers.

In addition to the taper current detection, the TPS65010 terminates charge in the event that the charge current falls below the  $I_{(TERM)}$  threshold. This feature allows for quick recognition of a battery removal condition. When a full battery is replaced with an empty battery, the TPS65010 detects that the VBAT voltage is below the recharge threshold and starts charging the new battery. The taper and termination bits are cleared in the CHGSTATUS register and if the  $\overline{INT}$  pin is still active due to these two interrupt sources, then it is de-asserted. Depending on the transient seen at the VCC pin, all registers may be set to their default values and require reprogramming with any nondefault values required, such as enabling the fast charge timer and taper termination; this should only happen if VCC drops below approximately 2 V.

### Sleep Mode

The TPS65010 charger enters the low-power sleep mode if both input sources are removed from the circuit. This feature prevents draining the battery during the absence of input power.

### $\overline{PG}$ Output

The open-drain power good ( $\overline{PG}$ ) output indicates when a valid power supply is present for the charger. This can be either from the ac adapter input or from the USB. The output turns ON when a valid voltage is detected. A valid voltage is detected whenever the voltage on either pin AC or pin USB rises above the voltage on VBAT plus 100 mV. This output is turned off in the sleep mode. The  $\overline{PG}$  pin can be used to drive an LED or communicate to the host processor. A voltage greater than the  $V_{(CHGOVLO)}$  threshold (typ 6.6 V) at the AC input is not valid and does not activate the  $\overline{PG}$  output. The  $\overline{PG}$  output is held in high impedance state if the charger is in reset by programming CHGCONFIG(6)=1.

The  $\overline{PG}$  output can also be programmed via the LED1\_ON and LED1\_PER registers in the serial interface. It can then be programmed to be permanently on, off, or to blink with defined on- and period-times.  $\overline{PG}$  is controlled per default via the charger.

## DETAILED DESCRIPTION (continued)

### Thermal Considerations for Setting Charge Current

The TPS65010 is housed in a 48-pin QFN package with exposed leadframe on the underside. This 7 mm × 7 mm package exhibits a thermal impedance (junction-to-ambient) of 33 K/W when mounted on a JEDEC high-k board with zero air flow.

AMBIENT TEMPERATURE	MAX POWER DISSIPATION FOR $T_J = 125^\circ\text{C}$	DERATING FACTOR ABOVE $T_A = 55^\circ\text{C}$
25°C	3 W	30 mW/°C
55°C	2.1 W	

Consideration needs to be given to the maximum charge current when the assembled application board exhibits a thermal impedance, which differs significantly from the JEDEC high-k board. The charger has a thermal shutdown feature, which suspends charging if the TPS65010 junction temperature rises above a threshold of 145°C. This threshold is set 15°C below the threshold used to power down the TPS65010 completely.

### STEP-DOWN CONVERTERS, VMAIN AND VCORE

The TPS65010 incorporates two synchronous step-down converters operating typically at 1.25 MHz fixed frequency pulse width modulation (PWM) at moderate to heavy load currents. At light load currents the converters automatically enter power save mode and operate with pulse frequency modulation (PFM). The main converter is capable of delivering 1-A output current and the core converter is capable of delivering 400 mA.

The converter output voltages are programmed via the VDCDC1 and VDCDC2 registers in the serial interface. The main converter defaults to 3.0-V or 3.3-V output voltage depending on the DEFMAIN configuration pin, if DEFMAIN is tied to ground the default is 3.0 V, if it is tied to  $V_{CC}$  the default is 3.3 V. The core converter defaults to either 1.5 V or 1.6 V depending on whether the DEFCORE configuration pin is tied to GND or to  $V_{CC}$  respectively. Both the main and core output voltages can subsequently be reprogrammed after start-up via the serial interface. In addition, the LOW\_PWR pin can be used either to lower the core voltage to a value defined in the VDCDC2 register when the application processor is in deep sleep mode or to disable the core converter. An active signal at LOW\_PWR is ignored if the ENABLE\_LP bit is not set in the VDCDC1 register.

The step-down converter outputs (when enabled) are monitored by power good comparators, the outputs of which are available via the serial interface. The outputs of the dc-dc converters can be optionally discharged when the dc-dc converters are disabled.

During PWM operation the converters use a unique fast response voltage mode controller scheme with input voltage feed-forward to achieve good line and load regulation allowing the use of small ceramic input and output capacitors. At the beginning of each clock cycle initiated by the clock signal, the P-channel MOSFET switch is turned on and the inductor current ramps up until the comparator trips and the control logic turns off the switch. The current limit comparator also turns off the switch in case the current limit of the P-channel switch is exceeded. After the dead time preventing current shoot through, the N-channel MOSFET rectifier is turned on and the inductor current ramps down. The next cycle is initiated by the clock signal again turning off the N-channel rectifier and turning on the P-channel switch.

The error amplifier, together with the input voltage, determines the rise time of the saw tooth generator, and therefore, any change in input voltage or output voltage directly controls the duty cycle of the converter giving a very good line and load transient regulation.

The two dc-dc converters operate synchronized to each other, with the MAIN converter as the master. A 270° phase shift between the MAIN switch turn on and the CORE switch turn on decreases the input RMS current and smaller input capacitors can be used. This is optimized for a typical application where the MAIN converter regulates a Li-Ion battery voltage of 3.7 V to 3.3 V and the CORE from 3.7 V to 1.5 V

### Power Save Mode Operation

As the load current decreases, the converter enters the power save mode operation. During power save mode the converter operates with reduced switching frequency in PFM mode and with a minimum quiescent current to maintain high efficiency.

In order to optimize the converter efficiency at light load the average current is monitored and if in PWM mode the inductor current remains below a certain threshold, then power save mode is entered. The typical threshold can be calculated as follows:

$$I_{(\text{skipmain})} = \frac{V_{I(\text{MAIN})}}{17 \Omega} \quad I_{(\text{skipcore})} = \frac{V_{I(\text{CORE})}}{42 \Omega} \quad (1)$$

During the power save mode the output voltage is monitored with the comparator by the thresholds comp low and comp high. As the output voltage falls below the comp low threshold, set to typically 0.8% above the nominal  $V_{\text{out}}$ , the P-channel switch turns on. The converter then runs at 50% of the nominal switching frequency. If the load is below the delivered current then the output voltage rises until the comp high threshold is reached, typically 1.6% above the nominal  $V_{\text{out}}$ , whereupon all switching activity ceases, hence reducing the quiescent current to a minimum until the output voltage has dropped below comp low again. If the load current is greater than the delivered current, then the output voltage falls until it crosses the nominal output voltage threshold (comp low 2 threshold), whereupon power save mode is exited and the converter returns to PWM mode.

These control methods reduce the quiescent current to typically to 12- $\mu\text{A}$  per converter and the switching frequency to a minimum achieving the highest converter efficiency. Setting the comparator thresholds to typically 0.8% and 1.6% above the nominal output voltage at light load current results in a dynamic voltage positioning achieving lower absolute voltage drops during heavy load transient changes. This allows the converters to operate with a small output capacitor of just 10  $\mu\text{F}$  for the core and 22  $\mu\text{F}$  for the main output and still have a low absolute voltage drop during heavy load transient changes. Refer to Figure 30 for detailed operation of the power save mode. The power save mode can be disabled through the I<sup>2</sup>C interface to force the converters to stay in fixed frequency PWM mode.

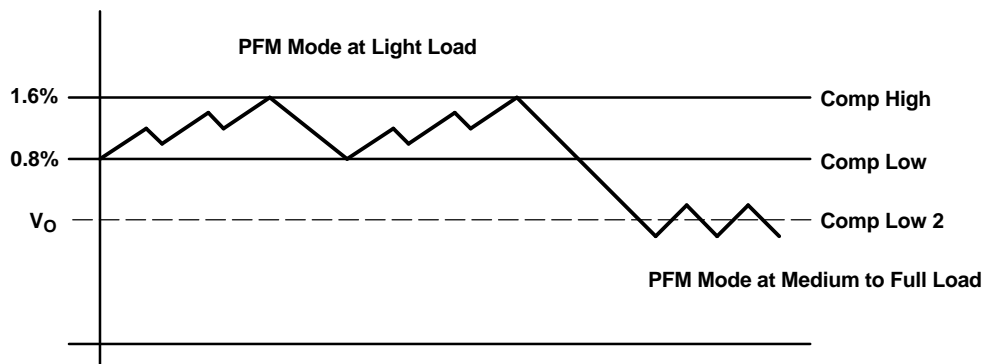

**Figure 30. Power Save Mode Thresholds and Dynamic Voltage Positioning**

### Forced PWM

The core and main converters are forced into PWM mode by setting bit 7 in the VDCDC1 register. This feature is used to minimize ripple on the output voltages.

### Dynamic Voltage Positioning

As described in the power save mode operation sections and as detailed in Figure 13, the output voltage is typically 1.2% above the nominal output voltage at light load currents as the device is in power save mode. This gives additional headroom for the voltage drop during a load transient from light load to full load. During a load transient from full load to light load the voltage overshoot is also minimized due to active regulation turning on the N-channel rectifier switch.

### Soft Start

Both converters have an internal soft start circuit that limits the inrush current during start-up. The soft start is implemented as a digital circuit increasing the switch current in 4 steps up to the typical maximum switch current limit of 700 mA (core) and 1.75 A (main). Therefore, the start-up time mainly depends on the output capacitor and load current.

### 100% Duty Cycle Low Dropout Operation

The TPS65010 converters offer a low input to output voltage difference while maintaining operation with the use of the 100% duty cycle mode. In this mode, the P-channel switch is constantly turned on. This is particularly useful in battery-powered applications to achieve longest operation time by taking full advantage of the whole battery voltage range. i.e., The minimum input voltage to maintain regulation depends on the load current and output voltage and is calculated as:

$$V_{I(\min)} = V_{O(\max)} + I_{O(\max)} \times (r_{DS(on)\max} + R_L) \quad (2)$$

with:

- $I_{O(\max)}$  = maximum output current plus inductor ripple current
- $r_{DS(on)\max}$  = maximum P-channel switch  $r_{DS(on)}$
- $R_L$  = DC resistance of the inductor
- $V_{O(\max)}$  = nominal output voltage plus maximum output voltage tolerance

### Active Discharge When Disabled

When the CORE and MAIN converters are disabled, due to an UVLO, BATT\_COVER or OVERTEMP condition, it is possible to actively pull down the outputs. This feature is disabled per default and is individually enabled via the VDCDC1 and VDCDC2 registers in the serial interface. When this feature is enabled, the core and main outputs are discharged by a 400-Ω (typical) load.

### Power Good Monitoring

Both the MAIN and CORE converters have power good comparators. Each comparator indicates when the relevant output voltage has dropped 10% below its target value, with 5% hysteresis. The outputs of these comparators are available in the REGSTATUS register via the serial interface. A maskable interrupt is generated when any voltage rail drops below the 10% threshold. The comparators are disabled when the converters are disabled.

### Overtemperature Shutdown

The MAIN and CORE converters are automatically shut down if the temperature exceeds the trip point (see the electrical characteristics). This detection is only active if the converters are in PWM mode, either by setting FPWM = 1, or if the output current is high enough that the device runs in PWM mode automatically.

## LOW-DROPOUT VOLTAGE REGULATORS

The low-dropout voltage regulators are designed to operate with low value ceramic input and output capacitors. They operate with input voltages down to 1.8 V. The LDOs offer a maximum dropout voltage of 300 mV at rated output current. Each LDO sports a current limit feature. Both LDOs are enabled per default, both LDOs can be disabled or programmed via the serial interface using the VREGS1 register. The LDO outputs (when enabled) are monitored by power good comparators, the outputs of which are available via the serial interface. The LDOs also have reverse conduction prevention when disabled. This allows the possibility to connect external regulators in parallel in systems with a backup battery.

### Power Good Monitoring

Both the LDO1 and LDO2 linear regulators have power good comparators. Each comparator indicates when the relevant output voltage has dropped 10% below its target value, with 5% hysteresis. The outputs of these comparators are available in the REGSTATUS register via the serial interface. An interrupt is generated when any voltage rail drops below the 10% threshold. The LDO2 comparator is disabled when LDO2 is disabled. The LDO1 power good comparator is always active since it generates the system reset signal,  $\overline{\text{RESPWRON}}$ , see the System Reset and Control Signal Section below. This also allows the possibility to monitor VLDO1, even if it is provided by an external regulator.

### **Enable and Sequencing**

Enabling and sequencing of the dc-dc converters and LDOs is described in the power-up sequencing section. The OMAP1510 processor from Texas Instruments requires that the core power supply is enabled before the I/O power supply, which means that the CORE converter should power up before the MAIN converter. This is achieved by connecting PS\_SEQ to GND.

### **UNDERVOLTAGE LOCKOUT**

The undervoltage lockout circuit for the four regulators on TPS65010 prevents the device from malfunctioning at low input voltages and from excessive discharge of the battery. Basically it prevents the converter from turning on the power switch or rectifier FET under undefined conditions. The undervoltage threshold voltage is set by default to 3.25 V. After power-up, the threshold voltage can be reprogrammed through the serial interface. The undervoltage lockout comparator compares the voltage on the VCC pin with the UVLO threshold. When the VCC voltage drops below this threshold, the TPS65010 sets the  $\overline{\text{PWRFAIL}}$  pin low and after a time  $t_{(\text{UVLO})}$  disables the voltage regulators in the sequence defined by PS\_SEQ. The same procedure is followed when the TPS65010 detects that its junction temperature has exceeded the overtemperature threshold, typically 160°C, with a delay  $t_{(\text{overtemp})}$ . The TPS65010 automatically restarts when the UVLO (or overtemperature) condition is no longer present.

The battery charger circuit has a separate UVLO circuit with a threshold of typically 2.5 V, which is compared with the voltage on AC and USB supply pins.

## POWER-UP SEQUENCING

The TPS65010 power-up sequencing is designed to allow the maximum flexibility without generating excessive logistical or system complexity. The relevant control pins are described in the following table:

**Table 1. Control Pins**

PIN NAME	INPUT/OUTPUT	FUNCTION
PS_SEQ	I	Input signal indicating power up and down sequence of the switching converters. PS_SEQ = 0 forces the core regulator to ramp up first and down last. PS_SEQ = 1 forces the main regulator to ramp up first and down last.
DEFCORE	I	Defines the default voltage of the VCORE switching converter. DEFCORE = 0 defaults VCORE to 1.5 V, DEFCORE = VCC defaults VCORE to 1.6 V.
DEFMAIN	I	Defines the default voltage of the VMAIN switching converter. DEFMAIN = 0 defaults VMAIN to 3.0 V, DEFMAIN = VCC defaults VMAIN to 3.3 V.
LOW_PWR	I	The LOW_PWR pin is used to lower VCORE to the preset voltage in the VDCDC2 register when the processor is in deep sleep mode. Alternatively VCORE can be disabled in low power mode if the LP_COREOFF bit is set in the VDCDC2 register. LOW_PWR is ignored if the ENABLE LP bit is not set in the VDCDC1 register. The TPS65010 uses the rising edge of the internal signal formed by a logical AND of LOW_PWR and ENABLE LP to enter low power mode. TPS65010 is forced out of low power mode by de-asserting LOW_PWR, by resetting ENABLE LP to 0, by activating the PB_ONOFF pin or by activating the HOT_RESET pin. There are two ways to get the device back into low power mode: a) toggle the LOW_PWR pin, or b) toggle the low power bit when the LOW_PWR pin is held high.
PB_ONOFF	I	PB_ONOFF can be used to exit the low power mode and return the core voltage to the value before low power mode was entered. If PB_ONOFF is used to exit the low power mode, then the low power mode can be reentered by toggling the LOW_PWR pin or by toggling the low power bit when the LOW_PWR pin is held high. A 1-M $\Omega$ pulldown resistor is integrated in TPS65010. PB_ONOFF is internally de-bounced by the TPS65010. A maskable interrupt is generated when PB_ONOFF is activated.
HOT_RESET	I	The HOT_RESET pin has a very similar functionality to the PB_ONOFF pin. In addition it generates a reset (MPU_RESET) for the MPU when the VCORE voltage is in regulation. HOT_RESET does not alter any TPS65010 settings unless low power mode was active in which case it is exited. A 1-M $\Omega$ pullup resistor to VCC is integrated in TPS65010. HOT_RESET is internally de-bounced by the TPS65010.
BATT_COVER	I	The BATT_COVER pin is used as an early warning that the main battery is about to be removed. BATT_COVER = VCC indicates that the cover is in place, BATT_COVER = 0 indicates that the cover is not in place. TPS65010 generates a maskable interrupt when the BATT_COVER pin goes low. PWRFAIL is also held low when BATT_COVER goes low. This feature may be disabled, by tying BATT_COVER permanently to VCC. The TPS65010 shuts down the main and the core converters, and sets the LDOs into low power mode. A 2-M $\Omega$ pulldown resistor is integrated in the TPS65010 at the BATT_COVER pin. BATT_COVER is internally de-bounced by the TPS65010.
RESPWRON	O	RESPWRON is held low while the switching converters (and any LDO's defined as default on) are starting up. It is determined by the state of LDO1's output voltage; when this is good then RESPWRON is high, when VLDO1 is low then RESPWRON is low. RESPWRON is held low for $t_{n}(\text{RESPWRON})$ sec after VLDO1 has settled.
MPU_RESET	O	MPU_RESET can be used to reset the processor if the user activates the HOT_RESET button. The MPU_RESET output is active for $t_{(\text{MPU\_nRESET})}$ sec. It also forces TPS65010 to leave low power mode. MPU_RESET is also held low as long as RESPWRON is held low.
PWRFAIL	O	PWRFAIL indicates when $V_{CC} < V_{(UVLO)}$ , when the TPS65010 is about to shut down due to an internal overtemperature condition or when BATT_COVER is low. PWRFAIL is also held low as long as RESPWRON is held low.

Figure 31 shows the state diagram for the TPS65010 power sequencing. The charger function is not shown in the state diagram since this function is independent of these states.

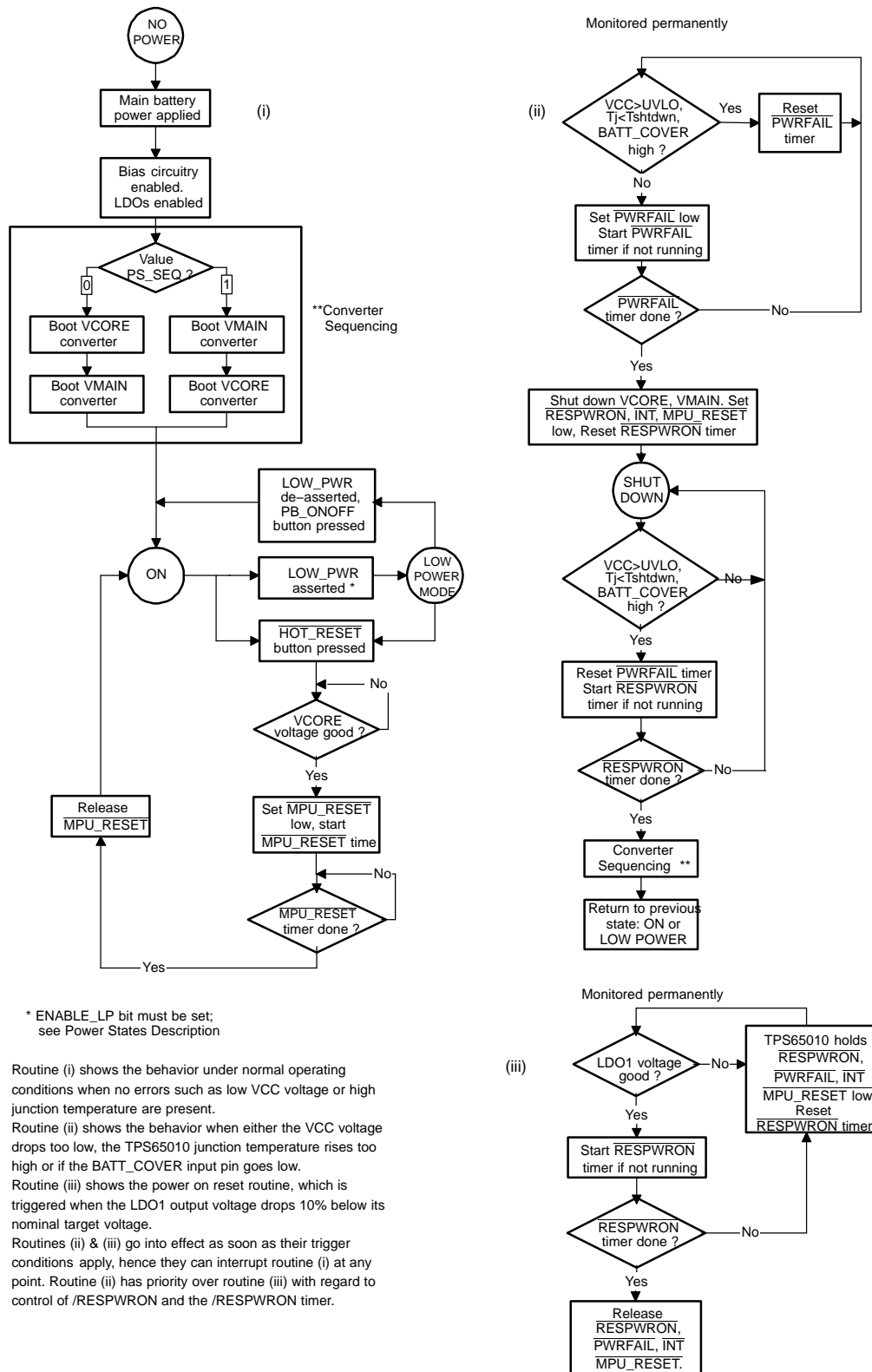

Routine (i) shows the behavior under normal operating conditions when no errors such as low VCC voltage or high junction temperature are present.

Routine (ii) shows the behavior when either the VCC voltage drops too low, the TPS65010 junction temperature rises too high or if the BATT\_COVER input pin goes low.

Routine (iii) shows the power on reset routine, which is triggered when the LDO1 output voltage drops 10% below its nominal target voltage.

Routines (ii) & (iii) go into effect as soon as their trigger conditions apply, hence they can interrupt routine (i) at any point. Routine (ii) has priority over routine (iii) with regard to control of /RESPWRON and the /RESPWRON timer.

Figure 31. TPS65010 Power-On State Diagram

## TPS65010 Power States Description

### State 1: No Power

There are no batteries connected to the TPS65010. When main power is applied, the bandgap reference, LDOs, and UVLO comparator start up. The  $\overline{\text{RESPWRON}}$ ,  $\overline{\text{PWRFAIL}}$ ,  $\overline{\text{INT}}$  and  $\overline{\text{MPU\_RESET}}$  signals are held low. When  $\text{BATT\_COVER}$  goes high (de-bounced internally by the TPS65010), indicating that the battery cover has been put in place and if  $\text{VCC} > \text{UVLO}$ , the power supplies are ramped in the sequence defined by  $\text{PS\_SEQ}$ .  $\overline{\text{RESPWRON}}$ ,  $\overline{\text{PWRFAIL}}$ ,  $\overline{\text{INT}}$  and  $\overline{\text{MPU\_RESET}}$  are released when the  $\overline{\text{RESPWRON}}$  timer has timed out after  $t_{n(\overline{\text{RESPWRON}})}$  sec. If  $\text{VCC}$  remains valid and no  $\overline{\text{OVERTEMP}}$  condition occurs then the TPS65010 arrives in State 2: ON. If  $\text{VCC} < \text{UVLO}$  the TPS65010 keeps the bandgap reference and UVLO comparator active such that when  $\text{VCC} > \text{UVLO}$  (during battery charge) the supplies are automatically activated.

### State 2: ON

In this state, TPS65010 is fired up and ready to go. The switching converters can have their output voltages programmed, the LDOs can be disabled or programmed. TPS65010 can exit this state either due to an overtemperature condition, by an undervoltage condition at  $\text{VCC}$ , by  $\text{BATT\_COVER}$  going low, or by the processor programming low power mode. State 2 is left temporarily if the user activates the  $\overline{\text{HOT\_RESET}}$  pin.

### State 3: Low Power Mode

This state is entered via the processor setting the  $\text{ENABLE\_LP}$  bit in the serial interface and then raising the  $\text{LOW\_PWR}$  pin. The TPS65010 actually uses the rising edge of the internal signal formed by a logical AND of the  $\text{LOW\_PWR}$  and  $\text{ENABLE LP}$  signals to enter low power mode. The  $\text{VMAIN}$  switching converter remains active, but the  $\text{VCORE}$  converter may be disabled in low power mode via the serial interface by setting the  $\text{LP\_COREOFF}$  bit in the  $\text{VDCDC2}$  register. If left enabled, the  $\text{VCORE}$  voltage is set to the value predefined by the  $\text{CORELP0/1}$  bits in the  $\text{VDCDC2}$  register. The  $\text{LDO1OFF/nSLP}$  and  $\text{LDO2OFF/nSLP}$  bits in the  $\text{VREGS1}$  register determine whether the LDOs are turned off or put in a reduced power mode (transient speed-up circuitry disabled in order to minimize quiescent current) in low power mode. All TPS65010 features remain addressable via the serial interface. TPS65010 can exit this state either due to an undervoltage condition at  $\text{VCC}$ , due to  $\text{BATT\_COVER}$  going low, due to an  $\overline{\text{OVERTEMP}}$  condition, by the processor deasserting the  $\text{LOW\_POWER}$  pin or by the user activating the  $\overline{\text{HOT\_RESET}}$  pin or the  $\text{PB\_ONOFF}$  pin.

### State 4: Shutdown

This state is entered automatically when either the  $\text{VCC}$  voltage is below  $\text{UVLO}$  the threshold, or if the TPS65010 junction temperature is too high, or if the  $\text{BATT\_COVER}$  pins goes low. The shutdown state is left when the error condition no longer applies.

Table 2 indicates the typical quiescent current consumption in each power state.

**Table 2. TPS65010 Typical Current Consumption**

STATE	TOTAL QUIESC- ENT CURRENT	QUIESCIENT CURRENT BREAKDOWN
1	0	
2	30 $\mu\text{A}$ -70 $\mu\text{A}$	$\text{VMAIN}$ (12 $\mu\text{A}$ ) + $\text{VCORE}$ (12 $\mu\text{A}$ ) + LDOs (20 $\mu\text{A}$ each, max 2) + $\text{UVLO}$ + reference + PowerGood
3	30 $\mu\text{A}$ -55 $\mu\text{A}$	$\text{VMAIN}$ (12 $\mu\text{A}$ ) + $\text{VCORE}$ (12 $\mu\text{A}$ ) + LDOs (10 $\mu\text{A}$ each, max 2) + $\text{UVLO}$ + reference + PowerGood
4	13 $\mu\text{A}$	$\text{UVLO}$ + reference circuitry

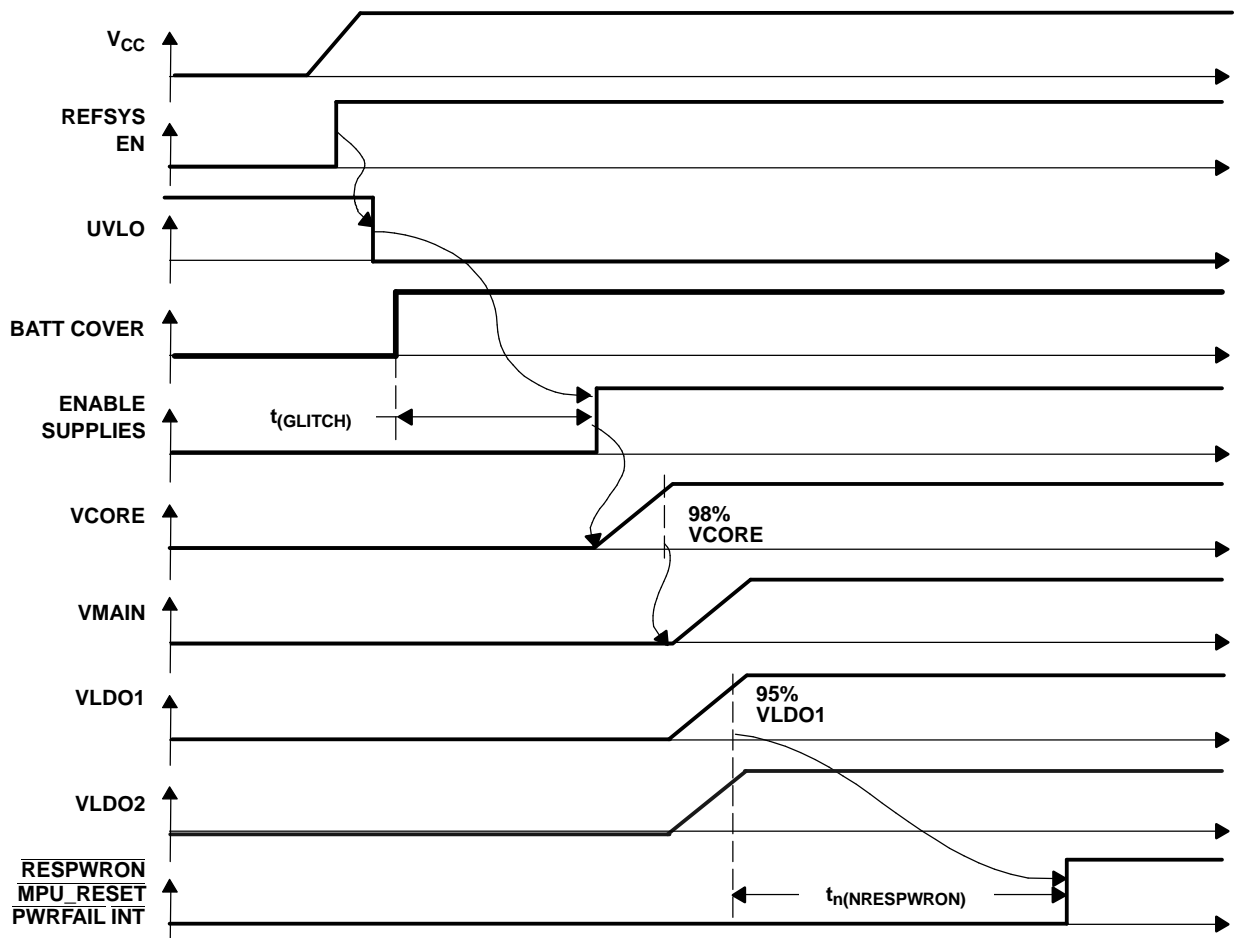

**Figure 32. State 1 to State 2 Transition (PS\_SEQ=0, V<sub>CC</sub> > V<sub>UVLO</sub> + HYST)**

Valid for LDO1 supplied from VMAIN as described earlier in this *Application Section*.

If 2.4 ms after application, V<sub>CC</sub> is still below the default UVLO threshold (3.425 V for V<sub>CC</sub> rising), then start up is as shown in Figure 33.

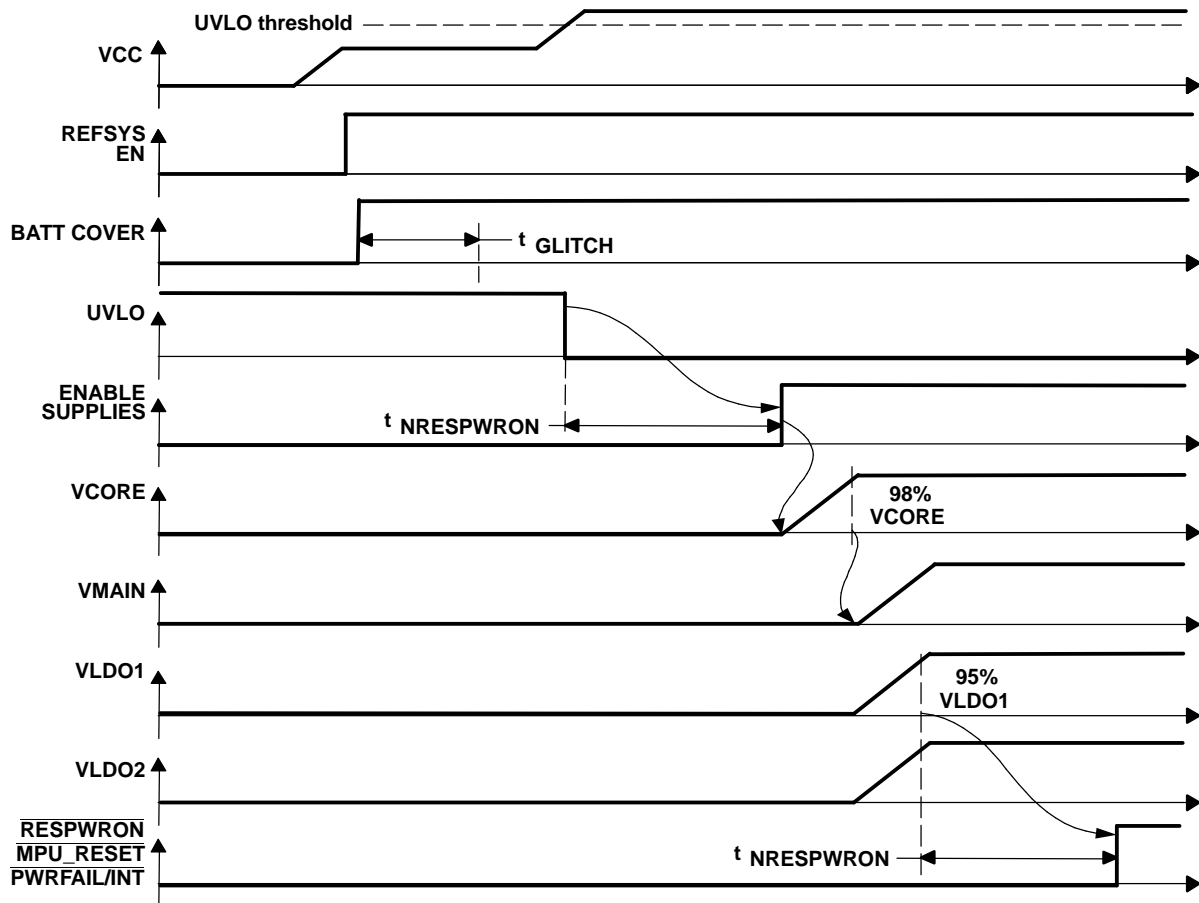
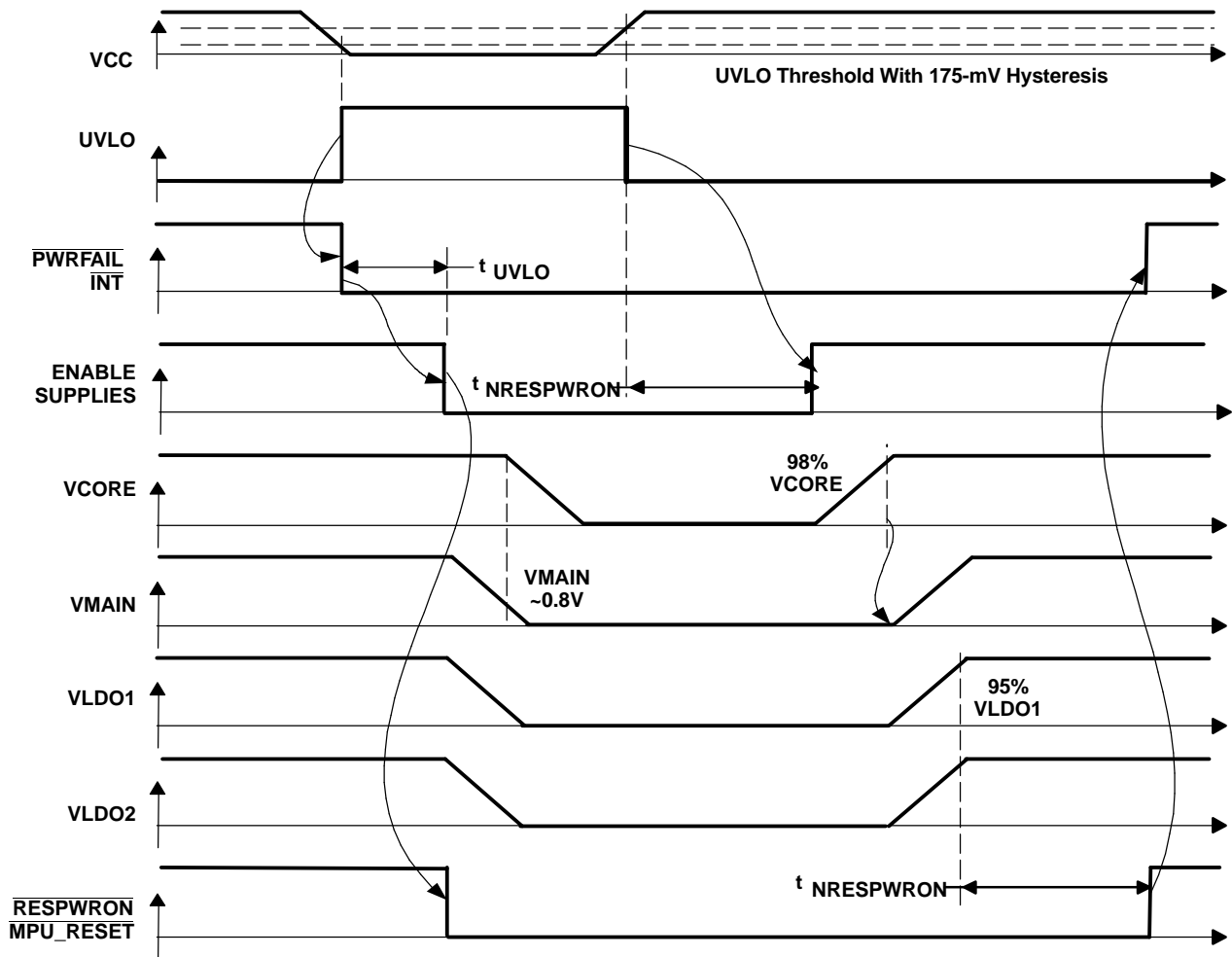

Figure 33. State1-State4-State 2 Transition (Power up behavior when  $V_{CC}$  ramp is longer than 2.4 ms)

Valid for LDO1 supplied from VMAIN as described earlier in this *Application Section*.



**Figure 34. State2-State4-State 2 Transition**

Valid for LDO1 supplied from VMAIN as described earlier in this *Application Section*.

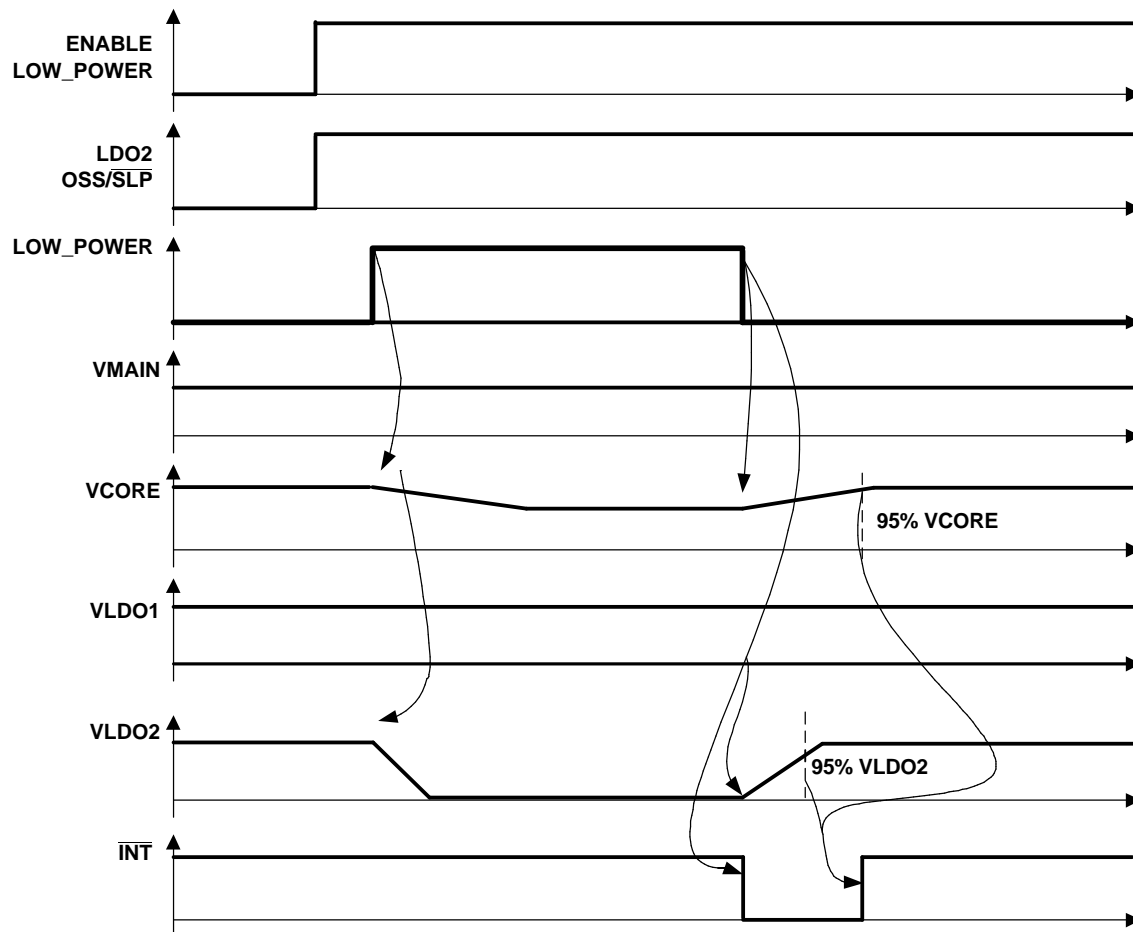

Figure 35. State 2 to State 3 Transition. VCORE Lowered, LDO2 Disabled. Subsequent State 3 to State 2 Transition When LOW POWER Is Deasserted.

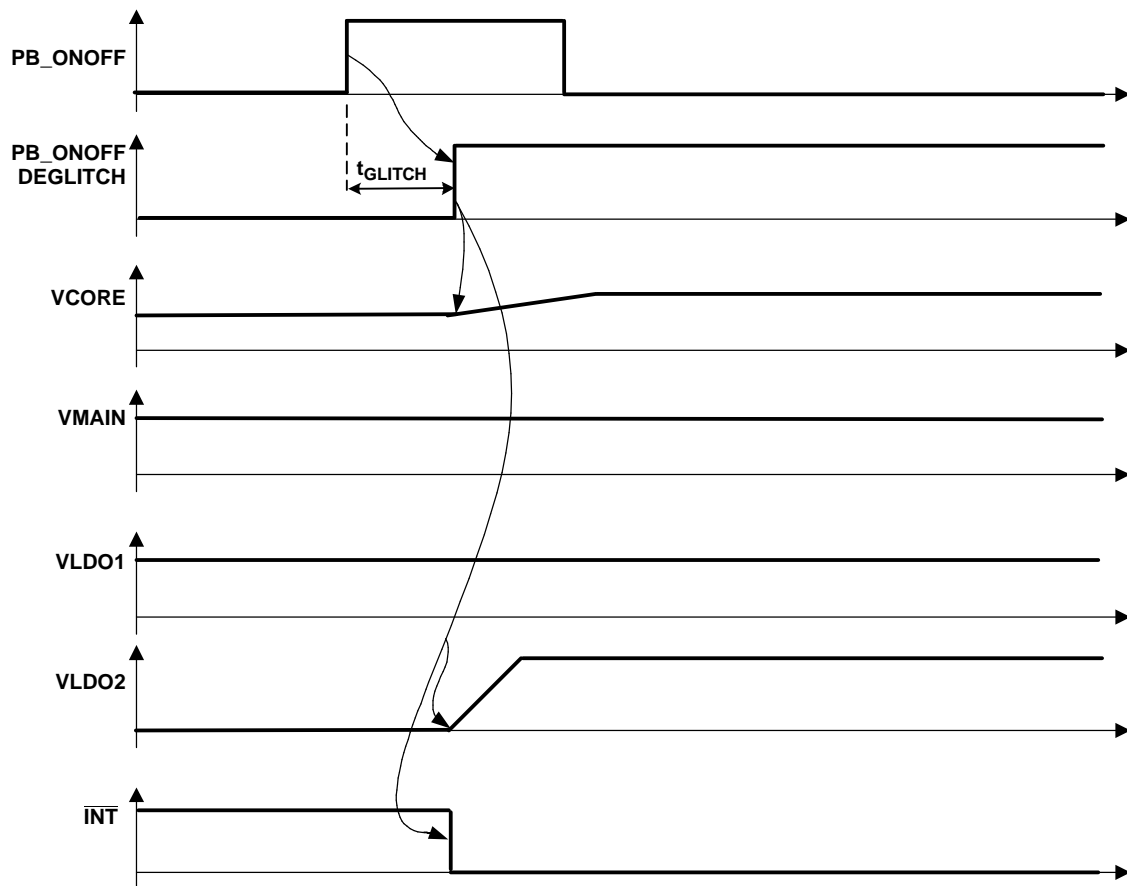

Figure 36. State 3 to State 2 Transition. PB\_ONFF Activated (See Interrupt Management Section for  $\overline{INT}$  Behavior)

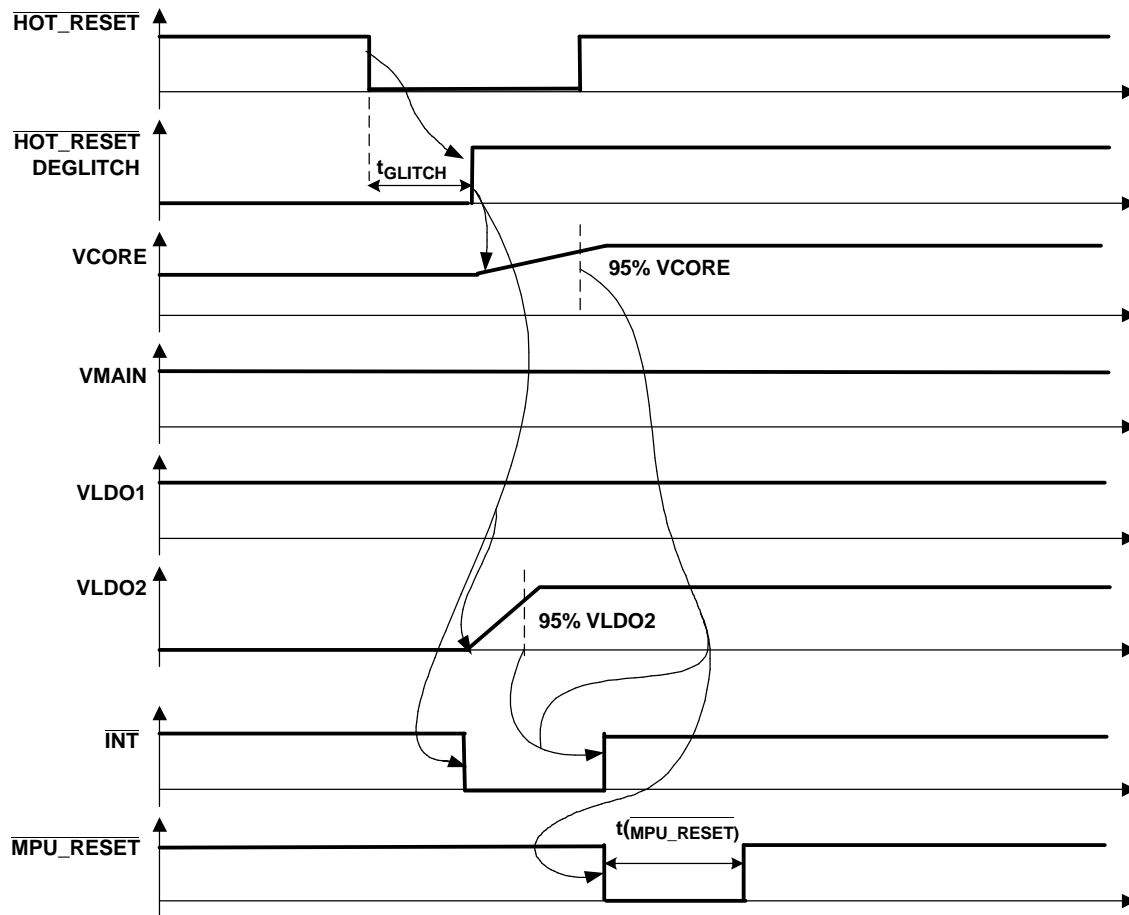

Figure 37. State 3 to State 2 Transition ( $\overline{\text{HOT\_RESET}}$  Activated, See Interrupt Management Section for  $\overline{\text{INT}}$  Behavior)

### SYSTEM RESET AND CONTROL SIGNALS

The  $\overline{\text{RESPWRON}}$  signal is used as a global reset for the application. It is an open drain output. The  $\overline{\text{RESPWRON}}$  signal is generated according to the Power Good comparator linked to VLDO1 and remains low for  $t_{n(\text{RESPWRON})}$  sec after VLDO1 has stabilized. When  $\overline{\text{RESPWRON}}$  is low,  $\overline{\text{PWRFAIL}}$ ,  $\overline{\text{MPU\_RESET}}$  and  $\overline{\text{INT}}$  are also held low.

If the output voltage of LDO1 is less than 90% of its nominal value, as  $\overline{\text{RESPWRON}}$  is generated, and if the output voltage of LDO1 is programmed to a higher value, which causes the output voltage to fall out of the 90% window, then a  $\overline{\text{RESPWRON}}$  signal is generated.

The  $\overline{\text{PWRFAIL}}$  signal indicates when  $VCC < UVLO$  or when the TPS65010 junction temperature has exceeded a reliable value or if  $\text{BATT\_COVER}$  is taken low. This open drain output can be connected at a fast interrupt pin for immediate attention by the application processor. All supplies are disabled  $t_{(uvlo)}$ ,  $t_{(overtemp)}$  or  $t_{(batt\_cover)}$  sec after  $\overline{\text{PWRFAIL}}$  has gone low, giving time for the application processor to shutdown cleanly.

$\text{BATT\_COVER}$  is used to detect whether the battery cover is in place or not. If the battery cover is removed, the TPS65010 generates a warning to the processor that the battery is likely to be removed and that it may be prudent to shut down the system. If not required, this feature may be disabled by connecting the  $\text{BATT\_COVER}$  pin to the VCC pin.  $\text{BATT\_COVER}$  is de-bounced internally. Typical de-bounce time is 56 ms.  $\text{BATT\_COVER}$  has an internal 2-M $\Omega$  pull down.

The  $\overline{\text{HOT\_RESET}}$  input is used to generate an  $\overline{\text{MPU\_RESET}}$  signal for the application processor. The  $\overline{\text{HOT\_RESET}}$  pin could be connected to a user-activated button in the application. It can also be used to exit low power mode, in this case the TPS65010 waits until the V<sub>CORE</sub> voltage has stabilized before generating the  $\overline{\text{MPU\_RESET}}$  pulse. The  $\overline{\text{MPU\_RESET}}$  pulse is active low for  $t_{(\text{mpu\_reset})}$  sec.  $\overline{\text{HOT\_RESET}}$  has an internal 1-M $\Omega$  pull up to V<sub>CC</sub>.

The PB\_ONOFF input can be used to exit LOW POWER MODE. It is typically driven by a user-activated push-button in the application. Both  $\overline{\text{HOT\_RESET}}$  and PB\_ONOFF are de-bounced internally by the TPS65010. Typical de-bounce time is 56 ms. PB\_ONOFF has an internal 1-M $\Omega$  pull down.

PB\_ONOFF, BATT\_COVER and UVLO events also cause a normal, maskable interrupt to be generated and are noted in the REGSTATUS register.

## VIBRATOR DRIVER

The VIB open drain output is provided to drive a vibrator motor, controlled via the serial interface register VDCDC2. It has a maximum dropout of 0.5 V at 100-mA load. Typically an external resistor is required to limit the motor current, and a freewheel diode to limit the VIB overshoot voltage at turnoff.

## LED2 OUTPUT

The LED2 output can be programmed in the same way as the  $\overline{\text{PG}}$  output to blink or to be permanently on or off. The LED2\_ON and LED2\_PER registers are used to control the blink rate. For both  $\overline{\text{PG}}$  and LED2, the minimum blink on time is 10 ms and this can be increased in 127 10 ms-steps to 1280 ms. For both  $\overline{\text{PG}}$  and LED2, the minimum blink period is 100 ms and this can be increased in 127 100-ms steps to 12800 ms.

## INTERRUPT MANAGEMENT

The open drain  $\overline{\text{INT}}$  pin is used to combine and report all possible conditions via a single pin. Battery and chip temperature faults, precharge timeout, charge timeout, taper timeout and termination current are each capable of setting  $\overline{\text{INT}}$  low, i.e. active.  $\overline{\text{INT}}$  can also be activated if any of the regulators are below the regulation threshold. Interrupts can also be generated by any of the GPIO pins programmed to be inputs. These inputs can be programmed to generate an interrupt either at the rising or falling edge of the input signal. It is possible to mask an interrupt from any of these conditions individually by setting the appropriate bits in the MASK1, MASK2 or MASK3 registers. By default, all interrupts are masked. Interrupts are stored in the CHGSTATUS, REGSTATUS and DEFGPIO registers in the serial interface. CHGSTATUS and REGSTATUS interrupts are acknowledged by reading these registers. If a 1 is present in any location then the TPS65010 automatically sets the corresponding bit in the ACKINT1 or ACKINT2 registers and releases the  $\overline{\text{INT}}$  pin. The ACKINT register contents are self-clearing when the condition, which caused the interrupt, is removed. The applications processor should not normally need to access the ACKINT1 or ACKINT2 registers.

Interrupt events are always captured; thus when an interrupt source is unmasked,  $\overline{\text{INT}}$  may immediately go active due to a previous interrupt condition. This can be prevented by first reading the relevant STATUS register before unmasking the interrupt source.

If an interrupt condition occurs then the  $\overline{\text{INT}}$  pin is set low. The CHGSTATUS, REGSTATUS and DEFGPIO registers should be read. Bit positions containing a 1 (or possibly a 0 in DEFGPIO) are noted by the CPU and the corresponding situation resolved. The reading of the CHGSTATUS and REGSTATUS registers automatically acknowledges any interrupt condition in those registers and blocks the path to the  $\overline{\text{INT}}$  pin from the relevant bit(s). No interrupt should be missed during the read process since this process starts by latching the contents of the register before shifting them out at SDAT. Once the contents have been latched (takes a couple of nanoseconds), the register is free to capture new interrupt conditions. Hence the probability of missing anything is, for practical purposes, zero.

The following describes how registers 0x01 (CHGSTATUS) and 0x02 (REGSTATUS) are handled:

- CHGSTATUS(5,0) are positive edge set. Read of set CHGSTATUS(5,0) bits sets ACKINT1(5,0) bits.
- CHGSTATUS(7-6,4-1) are level set. Read of set CHGSTATUS(7-6,4-1) bits sets ACKINT1(7-6,4-1) bits.
- CHGSTATUS(5,0) clear when input signal low and ACKINT1(5,0) bits are already set.
- CHGSTATUS(7-6,4-1) clear when input signal is low.
- ACKINT1(7-0) clear when CHGSTATUS(7-0) is clear.
- REGSTATUS(7-5) are positive edge set. Read of set REGSTATUS(7-5) bits sets ACKINT2(7-5) bits.

- REGSTATUS(3-0) are level set. Read of set REGSTATUS(3-0) bits sets ACKINT2(3-0) bits.
- REGSTATUS(7-5) clear when input signal low and ACKINT1(7-5) bit are already set.
- REGSTATUS(3-0) clear when input signal is low.
- ACKINT2(7-0) clear when REGSTATUS(7-0) is clear.

The following describes the function of the 0x05 (ACKINT1) and 0x06 (ACKINT2) registers. These are not usually written to by the CPU since the TPS65010 internally sets/clears these registers:

- ACKINT1(7:0) - Bit is set when the corresponding CHGSTATUS set bit is read via I<sup>2</sup>C.
- ACKINT1(7:0) - Bit is cleared when the corresponding CHGSTATUS set bit clears.
- ACKINT2(7:0) - Bit is set when the corresponding REGSTATUS set bit is read via I<sup>2</sup>C.
- ACKINT2(7:0) - Bit is cleared when the corresponding REGSTATUS set bit clears.
- ACKINT1(7:0) - a bit set masks the corresponding CHGSTATUS bit from  $\overline{\text{INT}}$ .
- ACKINT2(7:0) - a bit set masks the corresponding REGSTATUS bit from  $\overline{\text{INT}}$ .

The following describes the function of the 0x03 (MASK1), 0x04 (MASK2) and 0x0F (MASK3) registers:

- MASK1(7:0) - a bit set in this register masks CHGSTATUS from  $\overline{\text{INT}}$ .
- MASK2(7:0) - a bit set in this register masks REGSTATUS from  $\overline{\text{INT}}$ .
- MASK3(7:4) - a bit set in this register detects a rising edge on GPIO.
- MASK3(7:4) - a bit cleared in this register detects a falling edge on GPIO.
- MASK3(3:0) - a bit set in this register clears GPIO Detect signal from  $\overline{\text{INT}}$ .

GPIO interrupts are located by reading the 0x10 (DEFGPIO) register. The application CPU stores, or can read from DEFGPIO<7:4>, which GPIO is set to input or output. This information together with the information on which edge the interrupt was generated (the CPU either knows this or can read it from MASK3<7:4>) determines whether the CPU is looking for a 0 or a 1 in DEFGPIO<3:0>. A GPIO interrupt is blocked from the  $\overline{\text{INT}}$  pin by setting the relevant MASK3<3:0> bit; this must be done by the CPU, there is no auto-acknowledge for the GPIO interrupts.

## SERIAL INTERFACE

The serial interface is compatible with the standard and fast mode I<sup>2</sup>C specifications, allowing transfers at up to 400 kHz. The interface adds flexibility to the power supply solution, enabling most functions to be programmed to new values depending on the instantaneous application requirements and charger status to be monitored. Register contents remain intact as long as V<sub>CC</sub> remains above 2 V. The TPS65010 has a 7-bit address with the LSB set by the IFLSB pin, this allows the connection of two devices with the same address to the same bus. The 6 MSBs are 100100. Attempting to read data from register addresses not listed in this section results in FFh being read out.

For normal data transfer, DATA is allowed to change only when CLK is low. Changes when CLK is high are reserved for indicating the start and stop conditions. During data transfer, the data line must remain stable whenever the clock line is high. There is one clock pulse per bit of data. Each data transfer is initiated with a start condition and terminated with a stop condition. When addressed, the TPS65010 device generates an acknowledge bit after the reception of each byte. The master device (microprocessor) must generate an extra clock pulse that is associated with the acknowledge bit. The TPS65010 device must pull down the DATA line during the acknowledge clock pulse so that the DATA line is a stable low during the high period of the acknowledge clock pulse. The DATA line is a stable low during the high period of the acknowledge-related clock pulse. Setup and hold times must be taken into account. During read operations, a master must signal the end of data to the slave by not generating an acknowledge bit on the last byte that was clocked out of the slave. In this case, the slave TPS65010 device must leave the data line high to enable the master to generate the stop condition.

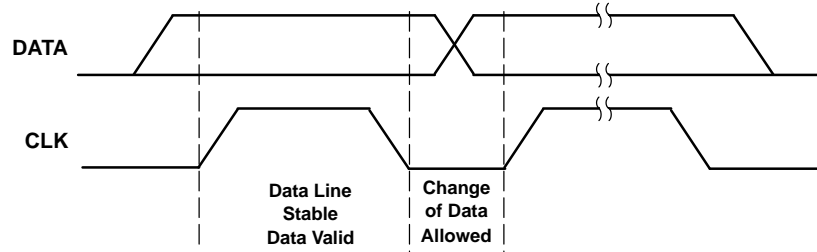

Figure 38. Bit Transfer on the Serial Interface

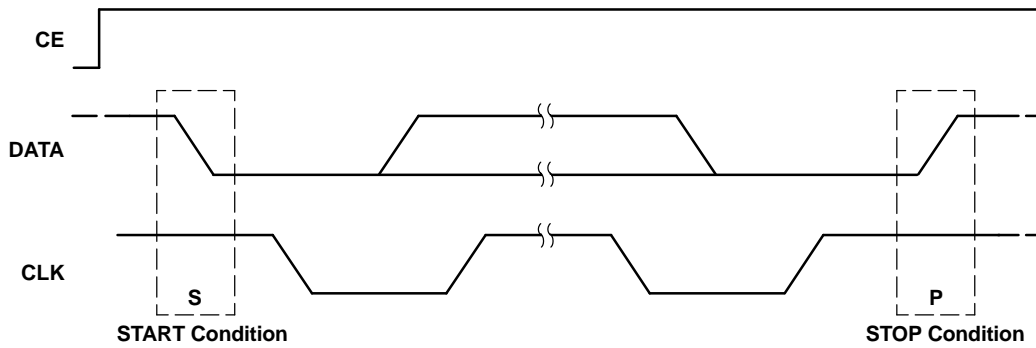

Figure 39. START and STOP Conditions

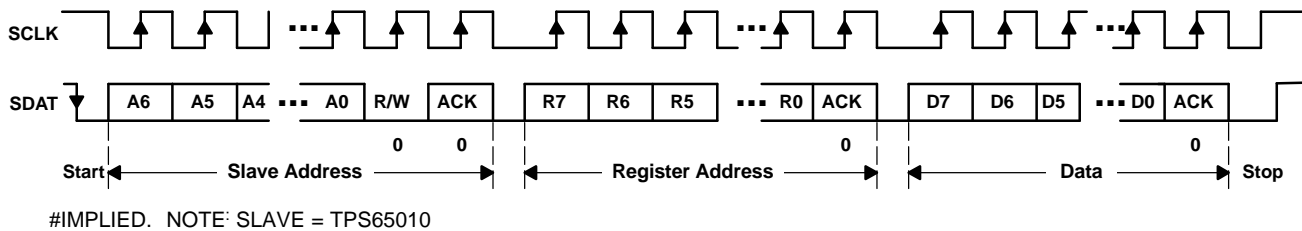

Figure 40. Serial Interface WRITE to TPS65010 Device

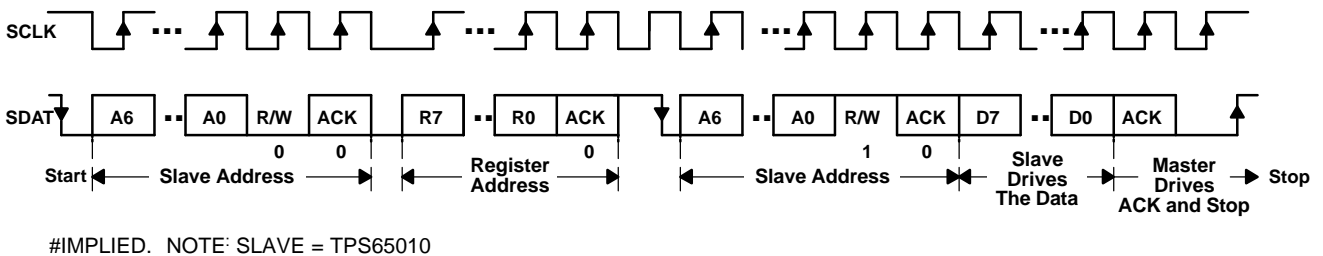
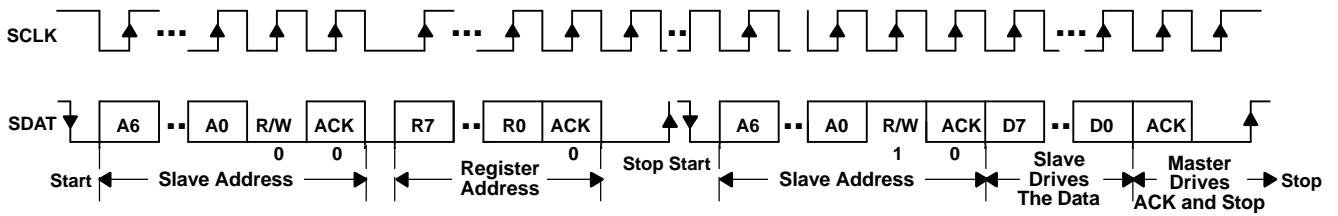

Figure 41. Serial Interface READ From TPS65010: Protocol A



#IMPLIED. NOTE: SLAVE = TPS65010

Figure 42. Serial Interface READ From TPS65010: Protocol B

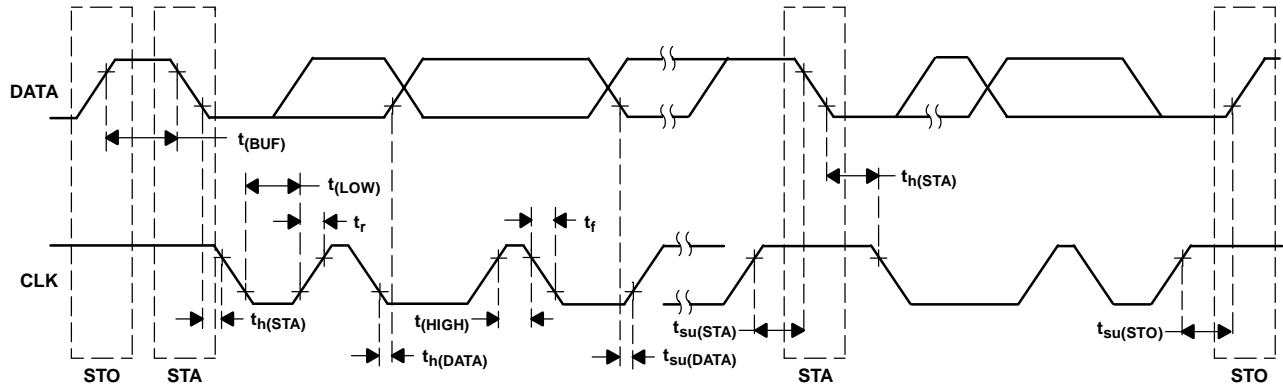

Figure 43. Serial Interface Timing Diagram

**CHGSTATUS Register (Address: 01h—Default Value: 00h)**

CHGSTATUS	B7	B6	B5	B4	B3	B2	B1	B0
Name	USB charge	AC charge	Thermal Suspend	Term Current	Taper Timeout	Chg Timeout	Prechg Timeout	BattTemp error
Default	0	0	0	0	0	0	0	0
Read/write	R	R	R	R	R/W	R/W	R/W	R

The CHGSTATUS register contents indicate the status of charge.

Bit 7 - USB charge:

- 0 = inactive.
- 1 = USB source is present and in the range valid for charging. B7 remains active as long as the charge source is present.

Bit 6 - AC charge:

- 0 = wall plug source is not present and/or not in the range valid for charging.
- 1 = wall plug source is present and in the range valid for charging. B6 remains active as long as the charge source is present.

Bit 5 - Thermal suspend:

- 0 = charging is allowed
- 1 = charging is momentarily suspended due to excessive power dissipation on chip.

Bit 4 - Term current:

- 0 = charging, charge termination current threshold has not been crossed.
- 1 = charge termination current threshold has been crossed and charging has been stopped. It can be due to a battery reaching full capacity, or it can be due to a battery removal condition.

Bit 3 - 1 Prechg Timeout, Chg Timeout, Taper Timeout:

- 0 = charging
- 1 = one of the timers has timed out and charging has been terminated.

Bit 0 - BattTemp error: Battery temperature error

- 0 = battery temperature is inside the allowed range and that charging is allowed.
- 1 = battery temperature is outside of the allowed range and that charging is suspended.

B1-4 may be reset via the serial interface in order to force a reset of the charger. Any attempt to write to B0 and B5-7 is ignored. A 1 in B<7:0> sets the  $\overline{\text{INT}}$  pin active unless the corresponding bit in the MASK register is set.

**REGSTATUS Register (Address: 02h—Default Value: 00h)**

REGSTATUS	B7	B6	B5	B4	B3	B2	B1	B0
Bit name	PB_ONOFF	BATT_COVER	UVLO		$\overline{\text{PGOOD}}$ LDO2	$\overline{\text{PGOOD}}$ LDO1	$\overline{\text{PGOOD}}$ MAIN	$\overline{\text{PGOOD}}$ CORE
Default	0	0	0	0	0	0	0	0
Read/write	R	R	R	R	R	R	R	R

**Bit 7 - PB\_ONOFF:**

- 0 = inactive
- 1 = user activated the PB\_ONOFF switch to request that all rails are shut down.

**Bit 6 - BATT\_COVER:**

- 0 = BATT\_COVER pin is high.
- 1 = BATT\_COVER pin is low.

**Bit 5 - UVLO:**

- 0 = voltage at the VCC pin above UVLO threshold.
- 1 = voltage at the VCC pin has dropped below the UVLO threshold.

**Bit 4 - not implemented**

**Bit 3 -  $\overline{\text{PGOOD}}$  LDO2:**

- 0 = LDO2 output in regulation, or LDO2 disabled with VREGS1<7> = 0
- 1 = LDO2 output out of regulation.

**Bit 2 -  $\overline{\text{PGOOD}}$  LDO1:**

- 0 = LDO1 output in regulation, or LDO1 disabled with VREGS1<3> = 0
- 1 = LDO1 output out of regulation.

**Bit 1 -  $\overline{\text{PGOOD}}$  MAIN:**

- 0 = Main converter output in regulation.
- 1 = Main converter output out of regulation.

**Bit 0 -  $\overline{\text{PGOOD}}$  CORE:**

- 0 = Core converter output in regulation.
- 1 = Core converter output out of regulation, or VDCDC2<7> = 1 in low power mode.

A rising edge in the REGSTATUS register contents causes  $\overline{\text{INT}}$  to be driven low if it is not masked in the MASK2.

**MASK1 Register (Address: 03h—Default Value: FFh)**

MASK1	B7	B6	B5	B4	B3	B2	B1	B0
Bit name	Mask USB	Mask AC	Mask Thermal Suspend	Mask Term	Mask Taper	Mask Chg	Mask Prechg	Mask BattTemp
Default	1	1	1	1	1	1	1	1
Read/write	R/W	R/W	R/W	R/W	R/W	R/W	R/W	R/W

The MASK1 register is used to mask all or any of the conditions in the corresponding CHGSTATUS<7:0> positions being indicated at the  $\overline{\text{INT}}$  pin. Default is to mask all.

**MASK2 Register (Address: 04h—Default Value: FFh)**

MASK2	B7	B6	B5	B4	B3	B2	B1	B0
Bit name	Mask PB_ONOFF	Mask BATT_COVER	Mask UVLO		Mask PGOOD LDO2	Mask PGOOD LDO1	Mask PGOOD MAIN	Mask PGOOD CORE
Default		1	1	1	1	1	1	1
Read/write	R/W	R/W	R/W	R/W	R/W	R/W	R/W	R/W

The MASK2 register is used to mask all or any of the conditions in the corresponding REGSTATUS<7:0> positions being indicated at the  $\overline{\text{INT}}$  pin. Default is to mask all.

**ACKINT1 Register (Address: 05h—Default Value: 00h)**

ACKINT1	B7	B6	B5	B4	B3	B2	B1	B0
Bit name	Ack USB	Ack AC	Ack Thermal Shutdown	Ack Term	Ack Taper	Ack Chg	Ack Prechg	Ack BattTemp
Default	0	0	0	0	0	0	0	0
Read/write	R	R	R	R	R	R	R	R

The ACKINT1 register is internally used to acknowledge any of the interrupts in the corresponding CHGSTATUS<7:0> positions. When this is done, the acknowledged interrupt is no longer fed through to the  $\overline{\text{INT}}$  pin and so the  $\overline{\text{INT}}$  pin becomes free to indicate the next pending interrupt. If none exists, then the  $\overline{\text{INT}}$  pin goes high, else it will remain low. A 1 at any position in ACKINT1 is automatically cleared when the corresponding interrupt condition in CHGSTATUS is removed. The application processor should not normally need to access the ACKINT1 register.

**ACKINT2 Register (Address: 06h—Default Value: 00h)**

ACKINT2	B7	B6	B5	B4	B3	B2	B1	B0
Bit name & function	Ack PB_ONOFF	Ack BATT_COVER	Ack UVLO		Ack PGOOD LDO2	Ack PGOOD LDO1	Ack PGOOD MAIN	Ack PGOOD CORE
Default	0	0	0	0	0	0	0	0
Read/write	R	R	R	R	R	R	R	R

The ACKINT2 register is internally used to acknowledge any of the interrupts in the corresponding REGSTATUS<7:0> positions. When this is done, the acknowledged interrupt is no longer fed through to the  $\overline{\text{INT}}$  pin and so the  $\overline{\text{INT}}$  pin becomes free to indicate the next pending interrupt. If none exists, then the  $\overline{\text{INT}}$  pin goes high, else it will remain low. A 1 at any position in ACKINT2 is automatically cleared when the corresponding interrupt condition in REGSTATUS is removed. The application processor should not normally need to access the ACKINT2 register.

**CHGCONFIG Register Address: 07h—Default Value: 1Bh**

CHGCONFIG	B7	B6	B5	B4	B3	B2	B1	B0
Bit name	POR	Charger reset	Fast charge timer + taper timer enabled	MSB charge current	LSB charge current	USB / 100 mA 500 mA	USB charge allowed	Charge enable
Default	0	0	0	1	1	0	1	1
Read/write	R/W	R/W	R/W	R/W	R/W	R/W	R/W	R/W

The CHGCONFIG register is used to configure the charger.

**Bit 7 - POR:**

- 0 =  $T_{n(\text{RESPWRON})}$  duration typically 1000 ms (+/-25%)
- 1 =  $T_{n(\text{RESPWRON})}$  duration typically 69 ms (+/-25%)

**Bit 6 - Charger reset:**

- Clears all the timers in the charger and forces a restart of the charge algorithm.
- 0 / 1 = This bit must be set and then reset via the serial interface.

Bit 5 - Fast charge timer + taper timer enabled:

- 0 = fast charge timer disabled (default)
- 1 = enables the fast charge timer.

Bit 4, Bit 3 - MSB/LSB Charge current:

- Used to set the constant current in the current regulation phase.

B4:B3	CHARGE CURRENT RATE
11	Maximum current set by the external resistor at the ISET pin
10	75% of maximum
01	50% of maximum
00	25% of maximum

Bit 2 - USB 100 mA / 500 mA:

- 0 = sets the USB charging current to max 100 mA.
- 1 = sets the USB charging current to max 500mA. B2 is ignored if B1=0.

Bit 1 - USB charge allowed:

- 0 = prevents any charging from the USB input.
- 1 = charging from the USB input is allowed.

Bit 0 - Charge enable:

- 0 = charging is not allowed.
- 1 = charger is free to charge from either of the two input sources. If both sources are present and valid, the TPS65010 charges from the ac source.

**LED1\_ON Register (Address: 08h—Default Value: 00h)**

LED1_ON	B7	B6	B5	B4	B3	B2	B1	B0
Bit name	$\overline{PG1}$	LED1 ON6	LED1 ON5	LED1 ON4	LED1 ON3	LED1 ON2	LED1 ON1	LED1 ON 0
Default	0	0	0	0	0	0	0	0
Read/write	R/W	R/W	R/W	R/W	R/W	R/W	R/W	R/W

The LED1\_ON and LED1\_PER registers can be used to take control of the  $\overline{PG}$  open drain output normally controlled by the charger.

Bit 7 -  $\overline{PG1}$ : Control of the  $\overline{PG}$  pin is determined by  $\overline{PG1}$  and  $\overline{PG2}$  according to the table under LED1\_PER register

Bit 6 - BIT 0 - LED1\_ON<6:0> are used to program the on-time of the open drain output transistor at the  $\overline{PG}$  pin. The minimum on time is typically 10 ms and one LSB corresponds to a 10-ms step change in the on time.

**LED1\_PER Register (Address: 09h—Default Value: 00h)**

LED1_PER	B7	B6	B5	B4	B3	B2	B1	B0
Bit name	$\overline{PG2}$	LED1 PER6	LED1 PER5	LED1 PER4	LED1 PER3	LED1 PER2	LED1 PER1	LED1 PER 0
Default	0	0	0	0	0	0	0	0
Read/write	R/W	R/W	R/W	R/W	R/W	R/W	R/W	R/W

Bit 7 -  $\overline{PG2}$ : Control of the  $\overline{PG}$  pin is determined by  $\overline{PG1}$  and  $\overline{PG2}$  according to the following table. Default shown in **bold**.

$\overline{PG1}$	$\overline{PG2}$	BEHAVIOR OF $\overline{PG}$ OPEN DRAIN OUTPUT
<b>0</b>	<b>0</b>	Under charger control
0	1	Blink
1	0	Off
1	1	Always On

Bit 6-Bit 0 - LED1\_PER<6:0> are used to program the time period of the open drain output transistor at the  $\overline{PG}$  pin. The minimum period is typically 100 ms and one LSB corresponds to a 100-ms step change in the period.

**LED2\_ON Register (Address: 0Ah—Default Value: 00h)**

LED2_ON	B7	B6	B5	B4	B3	B2	B1	B0
Bit name	LED21	LED2 ON6	LED2 ON5	LED2 ON4	LED2 ON3	LED2 ON2	LED2 ON1	LED2 ON0
Default	0	0	0	0	0	0	0	0
Read/write	R/W	R/W	R/W	R/W	R/W	R/W	R/W	R/W

The LED2\_ON and LED2\_PER registers are used to control the LED2 open drain output.

Bit 7 LED22: Control is determined by LED21 and LED22 according to the table under LED2\_PER register.

Bit 6-Bit 0 - LED2\_ON<6:0> are used to program the on-time of the open drain output transistor at the LED2 pin. The minimum on time is typically 10 ms and one LSB corresponds to a 10-ms step change in the on time.

**LED2\_PER (Register Address: 0Bh—Default Value: 00h)**

LED2_PER	B7	B6	B5	B4	B3	B2	B1	B0
Bit name	LED22	LED2 PER6	LED2 PER5	LED2 PER4	LED2 PER3	LED2 PER2	LED2 PER1	LED2 PER 0
Default	0	0	0	0	0	0	0	0
Read/write	R/W	R/W	R/W	R/W	R/W	R/W	R/W	R/W

Bit 7 LED22: Control is determined by LED21 and LED22 according to the table. Default shown in **bold**.

Bit 6-Bit 0 - LED2\_ON<6:0> are used to program the on-time of the open drain output transistor at the LED2 pin. The minimum on time is typically 100 ms and one LSB corresponds to a 100-ms step change in the on time.

LED21	LED22	BEHAVIOR OF LED2 OPEN DRAIN OUTPUT
0	0	Off
0	1	Blink
1	0	Off
1	1	Always On

**VDCDC1 Register (Address: 0Ch—Default Value: 72h/73h)**

VDCDC1	B7	B6	B5	B4	B3	B2	B1	B0
Bit name	FPWM	UVLO1	UVLO0	ENABLE SUPPLY	ENABLE LP	MAIN DIS-CHARGE	MAIN1	MAIN0
Default	0	1	1	1	0	0	1	DEFMAIN
Read/write	R/W	R/W	R/W	R/W	R/W	R/W	R/W	R/W

The VDCDC1 register is used to program the VMAIN switching converter.

Bit 7 - FPWM: forced PWM mode for dc-dc converters.

- 0 = MAIN and the CORE dc-dc converter are allowed to switch into PFM mode.
- 1 = MAIN and the CORE dc-dc converter operate with forced fixed frequency PWM mode and are not allowed to switch into PFM mode at light load.

Bit 6-Bit 5 - UVLO<1:0>: The under-voltage threshold voltage is set by UVLO1 and UVLO0 according to the below table, with the default value in **bold**.

UVLO1	UVLO0	V <sub>UVLO</sub>
0	0	2.5 V
0	1	2.75 V
1	0	3.0 V
1	1	<b>3.25 V</b>

## Bit 4 - ENABLE SUPPLY:

- 0 = not allowed
- 1 = must be left set.

## Bit 3 - ENABLE LP:

- 0 = disables the low power function of the LOW\_PWR pin.
- 1 = enables the low power function of the LOW\_PWR pin.

## Bit 2 - MAIN DISCHARGE:

- 0 = disable the active discharge of the VMAIN converter output.
- 1 = enable the active discharge of the VMAIN converter output, when the converter is disabled.

Bit 1-Bit 0 - MAIN<1:0>: The VMAIN converter output voltages are set according to the following table, with the default values in bold set by the DEFMAIN pin. The default voltage can subsequently be over-written via the serial interface after start-up.

MAIN1	MAIN0	VMAIN
0	0	2.5 V
0	1	2.75 V
1	0	<b>3.0 V</b>
1	1	<b>3.3 V</b>

## VDCDC2 Register (Address: 0Dh—Default Value: 68h/78h)

VDCDC2	B7	B6	B5	B4	B3	B2	B1	B0
Bit name	LP_COREOFF	CORE2	CORE1	CORE0	CORELP1	CORELP0	VIB	CORE DISCHARGE
Default	0	1	1	DEFCORE	1	0	0	0
Read/write	R/W	R/W	R/W	R/W	R/W	R/W	R/W	R/W

The VDCDC2 register is used to program the VCORE switching converter output voltage. It is programmable in 8 steps between 0.85 V and 1.6 V. The default value is governed by the DEFCORE pin; DEFCORE=0 sets an output voltage of 1.5 V. DEFCORE=1 sets an output voltage of 1.6 V.

## Bit 7 - LP\_COREOFF:

- 0 = VCORE converter is enabled in low power mode.
- 1 = VCORE converter is disabled in low power mode.

Bit 6-Bit 4 - CORE<2:0>: The following table shows all possible values of VCORE. The default value can subsequently be overwritten via the serial interface after start-up.

CORE2	CORE1	CORE0	VCORE
0	0	0	0.85 V
0	0	1	1.0 V
0	1	0	<b>1.1 V</b>
0	1	1	1.2 V
1	0	0	1.3 V
1	0	1	1.4 V
1	1	0	<b>1.5 V</b>
1	1	1	<b>1.6 V</b>

Bit 3-Bit 2 - CORELP<1:0>: CORELP1 and CORELP0 can be used to set the VCORE voltage in low power mode. In low power mode, CORE2 is effectively '0', and CORE1, CORE0 take on the values programmed at CORELP1 and CORELP0, default '10' giving VCORE = 1.1V as default in low power mode. When low power mode is exited, VCORE reverts to the value set by CORE2, CORE1 & CORE0.

## Bit 1 - VIB:

- 0 = disables the VIB output transistor.
- 1 = enables the VIB output transistor to drive the vibrator motor.

Bit 0 - CORE DISCHARGE:

- 0 = disables the active discharge of the V<sub>CORE</sub> converter output.
- 1 = enables the active discharge of the V<sub>CORE</sub> converter, output, when the converter is disabled.

**VREGS1 Register (Address: 0Eh—Default Value: 88h)**

VREGS1	B7	B6	B5	B4	B3	B2	B1	B0
Bit name	LDO2 enable	LDO2 OFF / nSLP	LDO21	LDO20	LDO1 enable	LDO1 OFF / nSLP	LDO11	LDO10
Default	1	0	0	0	1	0	0	0
Read/write	R/W	R/W	R/W	R/W	R/W	R/W	R/W	R/W

The VREGS1 register is used to program and enable LDO1 and LDO2 and to set their behavior when low power mode is active. The LDO output voltages can be set either on the fly, while the relevant LDO is disabled, or simultaneously when the relevant enable bit is set. Note that both LDOs are per default ON.

Bit 7-Bit 6 - The function of the LDO2 enable and LDO2 OFF / nSLP bits is shown in the following table. See the power-on sequencing section for details of low-power mode.

LDO2 ENABLE	LDO2 OFF / nSLP	LDO STATUS IN NORMAL MODE	LDO STATUS IN LOW-POWER MODE
0	X	OFF	OFF
1	0	ON, full power	ON, reduced power / performance
1	1	ON, full power	OFF

Bit 5-Bit 4 - LDO2<1:0>: LDO2 has a default output voltage of 1.8 V. If so desired, this can be changed at the same time as it is enabled via the serial interface.

LDO21	LDO20	V <sub>LDO2</sub>
0	0	1.8 V
0	1	2.5 V
1	0	2.75 V
1	1	3.0 V

Bit 3-Bit 2 - The function of the LDO1 enable and LDO1 OFF / nSLP bits is shown in the following table. See the power-on sequencing section for details of low-power mode. Note that programming LDO1 to a higher voltage may force a system power on reset if the increase is in the 10% or greater range.

LDO1 ENABLE	LDO1 OFF / nSLP	LDO STATUS IN NORMAL MODE	LDO STATUS IN LOW-POWER MODE
0	X	OFF	OFF
1	0	ON, full power	ON, reduced power / performance
1	1	ON, full power	OFF

Bit 1-Bit 0 - LDO1<1:0>: The LDO1 output voltage is per default set externally. If so desired, this can be changed via the serial interface.

LDO11	LDO10	V <sub>LDO1</sub>
0	0	ADJ
0	1	2.5 V
1	0	2.75 V
1	1	3.0 V

**MASK3 Register (Address: 0Fh—Default Value: 00h)**

MASK3	B7	B6	B5	B4	B3	B2	B1	B0
Bit name	Edge trigger GPIO4	Edge trigger GPIO3	Edge trigger GPIO2	Edge trigger GPIO1	Mask GPIO4	Mask GPIO3	Mask GPIO2	Mask GPIO1
Default	0	0	0	0	0	0	0	0
Read/write	R/W	R/W	R/W	R/W	R/W	R/W	R/W	R/W

The MASK3 register must be considered when any of the GPIO pins are programmed as inputs.

Bit 7-Bit 4 - Edge trigger GPIO<4:1>: determine whether the respective GPIO generates an interrupt at a rising or a falling edge.

- 0 = falling edge triggered.
- 1 = rising edge triggered.

Bit 3-Bit 0 - Mask GPIO<4:1>: can be used to mask the corresponding interrupt. Default is unmasked (MASK3<0:3> = 0).

**DEFGPIO Register Address: (10h—Default Value: 00h)**

DEFGPIO	B7	B6	B5	B4	B3	B2	B1	B0
Bit name	IO4	IO3	IO2	IO1	Value GPIO4	Value GPIO3	Value GPIO2	Value GPIO1
Default	0	0	0	0	0	0	0	0
Read/write	R/W	R/W	R/W	R/W	R/W	R/W	R/W	R/W

The DEFGPIO register is used to define the GPIO pins to be either input or output.

Bit 7-Bit 4 - IO<4:1>:

- 0 = sets the corresponding GPIO to be an input.
- 1 = sets the corresponding GPIO to be an output.

Bit 3-Bit 0 - Value GPIO<4:1>: If a GPIO is programmed to be an output, then the signal output is determined by the corresponding bit. The output circuit for each GPIO is an open drain NMOS requiring an external pullup resistor.

- 1 = activates the relevant NMOS, hence forcing a logic low signal at the GPIO pin.
- 0 = turns the open drain transistor OFF, hence the voltage at the GPIO pin is determined by the voltage to which the pullup resistor is connected.

If a particular GPIO is programmed to be an input, then the contents of the relevant bit in B3-0 is defined by the logic level at the GPIO pin. A logic low forces a 0 and a logic high forces a 1. If a GPIO is programmed to be an input, then any attempt to write to the relevant bit in B3-0 is ignored.

## DESIGN PROCEDURE

### Inductor Selection for the Main and the Core Converter

The main and the core converters in the TPS65010 typically use a 6.2- $\mu$ H and a 10- $\mu$ H output inductor respectively. Larger or smaller inductor values can be used to optimize the performance of the device for specific operation conditions. The selected inductor has to be rated for its dc resistance and saturation current. The dc resistance of the inductance influences directly the efficiency of the converter. Therefore, an inductor with lowest dc resistance is selected for highest efficiency.

Equation 3 calculates the maximum inductor current under static load conditions. The saturation current of the inductor should be rated higher than the maximum inductor current as calculated with Equation 3. This is needed because during heavy load transient, the inductor current rises above the value calculated under Equation 3.

$$\Delta I_L = V_O \times \frac{1 - \frac{V_O}{V_I}}{L \times f} \quad (3)$$

$$I_{L(\max)} = I_{O(\max)} + \frac{\Delta I_L}{2} \quad (4)$$

with:

- $f$  = Switching Frequency (1.25 MHz typical)
- $L$  = Inductor Value
- $\Delta I_L$  = Peak-to-peak inductor ripple current
- $I_{L\max}$  = Maximum inductor current

The highest inductor current occurs at maximum  $V_I$ .

Open core inductors have a soft saturation characteristic and they can usually handle higher inductor currents versus a comparable shielded inductor.

A more conservative approach is to select the inductor current rating just for the maximum switch current of the TPS65010 (2 A for the main converter and 0.8 A for the core converter). Keep in mind that the core material from inductor to inductor differs and has an impact on the efficiency especially at high switching frequencies.

Refer to Table 3 and the typical applications for possible inductors

**Table 3. Tested Inductors**

DEVICE	INDUCTOR VALUE	DIMENSIONS	COMPONENT SUPPLIER
Core converter	10 $\mu$ H	6,0 mm $\times$ 6,0 mm $\times$ 2,0 mm	Sumida CDRH5D18-100
	10 $\mu$ H	5,0 mm $\times$ 5,0 mm $\times$ 3,0 mm	Sumida CDRH4D28-100
Main converter	4.7 $\mu$ H	5,5 mm $\times$ 6,6 mm*1.0 mm	Coilcraft LPO1704-472M
	4.7 $\mu$ H	5,0 mm $\times$ 5,0 mm $\times$ 3,0 mm	Sumida CDRH4D28C-4.7
	4.7 $\mu$ H	5,2 mm $\times$ 5,2 mm $\times$ 2,5 mm	Coiltronics SD25-4R7
	5.3 $\mu$ H	5,7 mm $\times$ 5,7 mm $\times$ 3,0 mm	Sumida CDRH5D28-5R3
	6.2 $\mu$ H	5,7 mm $\times$ 5,7 mm $\times$ 3,0 mm	Sumida CDRH5D28-6R2
	6.0 $\mu$ H	7,0 mm $\times$ 7,0 mm $\times$ 3,0 mm	Sumida CDRH6D28-6R0

### Output Capacitor Selection

The advanced fast response voltage mode control scheme of the inductive converters implemented in the TPS65010 allow the use of small ceramic capacitors with a typical value of 22  $\mu$ F for the main converter and 10  $\mu$ F for the core converter without having large output voltage under and overshoots during heavy load transients. Ceramic capacitors having low ESR values have the lowest output voltage ripple and are recommended. If required tantalum capacitors with an ESR < 100  $\Omega$ R may be used as well.

Refer to Table 4 for recommended components.

If ceramic output capacitors are used, the capacitor RMS ripple current rating always meet the application requirements. Just for completeness the RMS ripple current is calculated as:

$$I_{\text{RMSC(out)}} = V_O \times \frac{1 - \frac{V_O}{V_I}}{L \times f} \times \frac{1}{2 \times \sqrt{3}} \quad (5)$$

At nominal load current, the inductive converters operate in PWM mode and the overall output voltage ripple is the sum of the voltage spike caused by the output capacitor ESR plus the voltage ripple caused by charging and discharging the output capacitor:

$$\Delta V_O = V_O \times \frac{1 - \frac{V_O}{V_I}}{L \times f} \times \left( \frac{1}{8 \times C_O \times f} + \text{ESR} \right) \quad (6)$$

Where the highest output voltage ripple occurs at the highest input voltage  $V_I$ .

At light load currents, the converters operate in power save mode and the output voltage ripple is independent of the output capacitor value. The output voltage ripple is set by the internal comparator thresholds. The typical output voltage ripple is 1% of the nominal output voltage. If the output voltage for the core converter is programmed to its lowest voltage of 0.85 V, the output capacitor must be increased to 22  $\mu\text{F}$  for low output voltage ripple. This is because the current in the inductor decreases slowly during the off-time and further increases the output voltage even when the PMOS is off. This effect increases with low output voltages.

### Input Capacitor Selection

Because of the nature of the buck converter, having a pulsating input current a low ESR input capacitor is required for best input voltage filtering and minimizing the interference with other circuits caused by high input voltage spikes. The main converter needs a 22- $\mu\text{F}$  ceramic input capacitor and the core converter a 10- $\mu\text{F}$  ceramic capacitor. The input capacitor for the main and the core converter can be combined and one 22- $\mu\text{F}$  capacitor can be used instead, because the two converters operate with a phase shift of 270 degrees. The input capacitor can be increased without any limit for better input voltage filtering. The VCC pin should be separated from the input for the main and the core converter. A filter resistor of up to 100R and a 1- $\mu\text{F}$  capacitor is used for decoupling the VCC pin from switching noise.

**Table 4. Possible Capacitors**

CAPACITOR VALUE	CASE SIZE	COMPONENT SUPPLIER	COMMENTS
22 $\mu\text{F}$	1206	TDK C3216X5R0J226M	Ceramic
22 $\mu\text{F}$	1206	Taiyo Yuden JMK316BJ226ML	Ceramic
22 $\mu\text{F}$	1210	Taiyo Yuden JMK325BJ226MM	Ceramic

## LDO1

### Output Voltage Adjustment

The output voltage of LDO1 is set with a resistor divider at the feedback pin. The sum of the two resistors must not exceed 1 MR to minimize voltage changes due to leakage current into the feedback pin. The output voltage for LDO1 after start up is the voltage set by the external resistor divider. It can be reprogrammed with the I<sup>2</sup>C interface to the three other values defined in the register VREGS1.

**PACKAGING INFORMATION**

Orderable Device	Status (1)	Package Type	Package Drawing	Pins	Package Qty	Eco Plan (2)	Lead/Ball Finish	MSL Peak Temp (3)	Op Temp (°C)	Top-Side Markings (4)	Samples
TPS65010RGZR	ACTIVE	VQFN	RGZ	48	2500	Green (RoHS & no Sb/Br)	CU NIPDAU	Level-2-260C-1 YEAR	-40 to 85	TPS65010	<a href="#">Samples</a>
TPS65010RGZRG4	ACTIVE	VQFN	RGZ	48	2500	Green (RoHS & no Sb/Br)	CU NIPDAU	Level-2-260C-1 YEAR	-40 to 85	TPS65010	<a href="#">Samples</a>
TPS65010RGZT	ACTIVE	VQFN	RGZ	48	250	Green (RoHS & no Sb/Br)	CU NIPDAU	Level-2-260C-1 YEAR		TPS65010	<a href="#">Samples</a>
TPS65010RGZTG4	ACTIVE	VQFN	RGZ	48	250	Green (RoHS & no Sb/Br)	CU NIPDAU	Level-2-260C-1 YEAR		TPS65010	<a href="#">Samples</a>

(1) The marketing status values are defined as follows:

**ACTIVE:** Product device recommended for new designs.

**LIFEBUY:** TI has announced that the device will be discontinued, and a lifetime-buy period is in effect.

**NRND:** Not recommended for new designs. Device is in production to support existing customers, but TI does not recommend using this part in a new design.

**PREVIEW:** Device has been announced but is not in production. Samples may or may not be available.

**OBSOLETE:** TI has discontinued the production of the device.

(2) Eco Plan - The planned eco-friendly classification: Pb-Free (RoHS), Pb-Free (RoHS Exempt), or Green (RoHS & no Sb/Br) - please check <http://www.ti.com/productcontent> for the latest availability information and additional product content details.

**TBD:** The Pb-Free/Green conversion plan has not been defined.

**Pb-Free (RoHS):** TI's terms "Lead-Free" or "Pb-Free" mean semiconductor products that are compatible with the current RoHS requirements for all 6 substances, including the requirement that lead not exceed 0.1% by weight in homogeneous materials. Where designed to be soldered at high temperatures, TI Pb-Free products are suitable for use in specified lead-free processes.

**Pb-Free (RoHS Exempt):** This component has a RoHS exemption for either 1) lead-based flip-chip solder bumps used between the die and package, or 2) lead-based die adhesive used between the die and leadframe. The component is otherwise considered Pb-Free (RoHS compatible) as defined above.

**Green (RoHS & no Sb/Br):** TI defines "Green" to mean Pb-Free (RoHS compatible), and free of Bromine (Br) and Antimony (Sb) based flame retardants (Br or Sb do not exceed 0.1% by weight in homogeneous material)

(3) MSL, Peak Temp. -- The Moisture Sensitivity Level rating according to the JEDEC industry standard classifications, and peak solder temperature.

(4) Multiple Top-Side Markings will be inside parentheses. Only one Top-Side Marking contained in parentheses and separated by a "~" will appear on a device. If a line is indented then it is a continuation of the previous line and the two combined represent the entire Top-Side Marking for that device.

**Important Information and Disclaimer:** The information provided on this page represents TI's knowledge and belief as of the date that it is provided. TI bases its knowledge and belief on information provided by third parties, and makes no representation or warranty as to the accuracy of such information. Efforts are underway to better integrate information from third parties. TI has taken and continues to take reasonable steps to provide representative and accurate information but may not have conducted destructive testing or chemical analysis on incoming materials and chemicals. TI and TI suppliers consider certain information to be proprietary, and thus CAS numbers and other limited information may not be available for release.

In no event shall TI's liability arising out of such information exceed the total purchase price of the TI part(s) at issue in this document sold by TI to Customer on an annual basis.



**TAPE AND REEL INFORMATION**

**QUADRANT ASSIGNMENTS FOR PIN 1 ORIENTATION IN TAPE**

\*All dimensions are nominal

Device	Package Type	Package Drawing	Pins	SPQ	Reel Diameter (mm)	Reel Width W1 (mm)	A0 (mm)	B0 (mm)	K0 (mm)	P1 (mm)	W (mm)	Pin1 Quadrant
TPS65010RGZR	VQFN	RGZ	48	2500	330.0	16.4	7.3	7.3	1.5	12.0	16.0	Q2
TPS65010RGZT	VQFN	RGZ	48	250	180.0	16.4	7.3	7.3	1.5	12.0	16.0	Q2

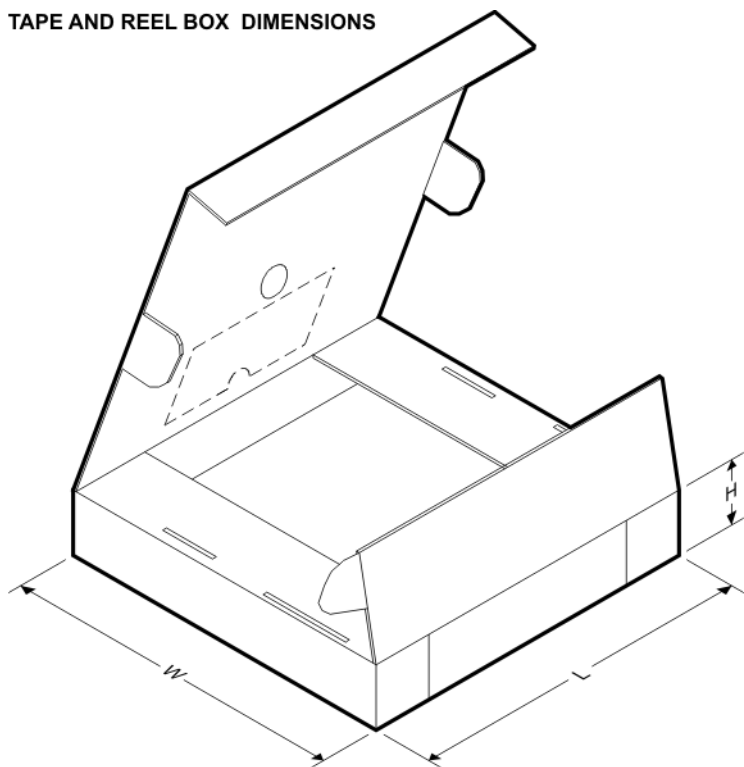
**TAPE AND REEL BOX DIMENSIONS**

\*All dimensions are nominal

Device	Package Type	Package Drawing	Pins	SPQ	Length (mm)	Width (mm)	Height (mm)
TPS65010RGZR	VQFN	RGZ	48	2500	336.6	336.6	28.6
TPS65010RGZT	VQFN	RGZ	48	250	213.0	191.0	55.0

RGZ (S-PVQFN-N48)

PLASTIC QUAD FLATPACK NO-LEAD

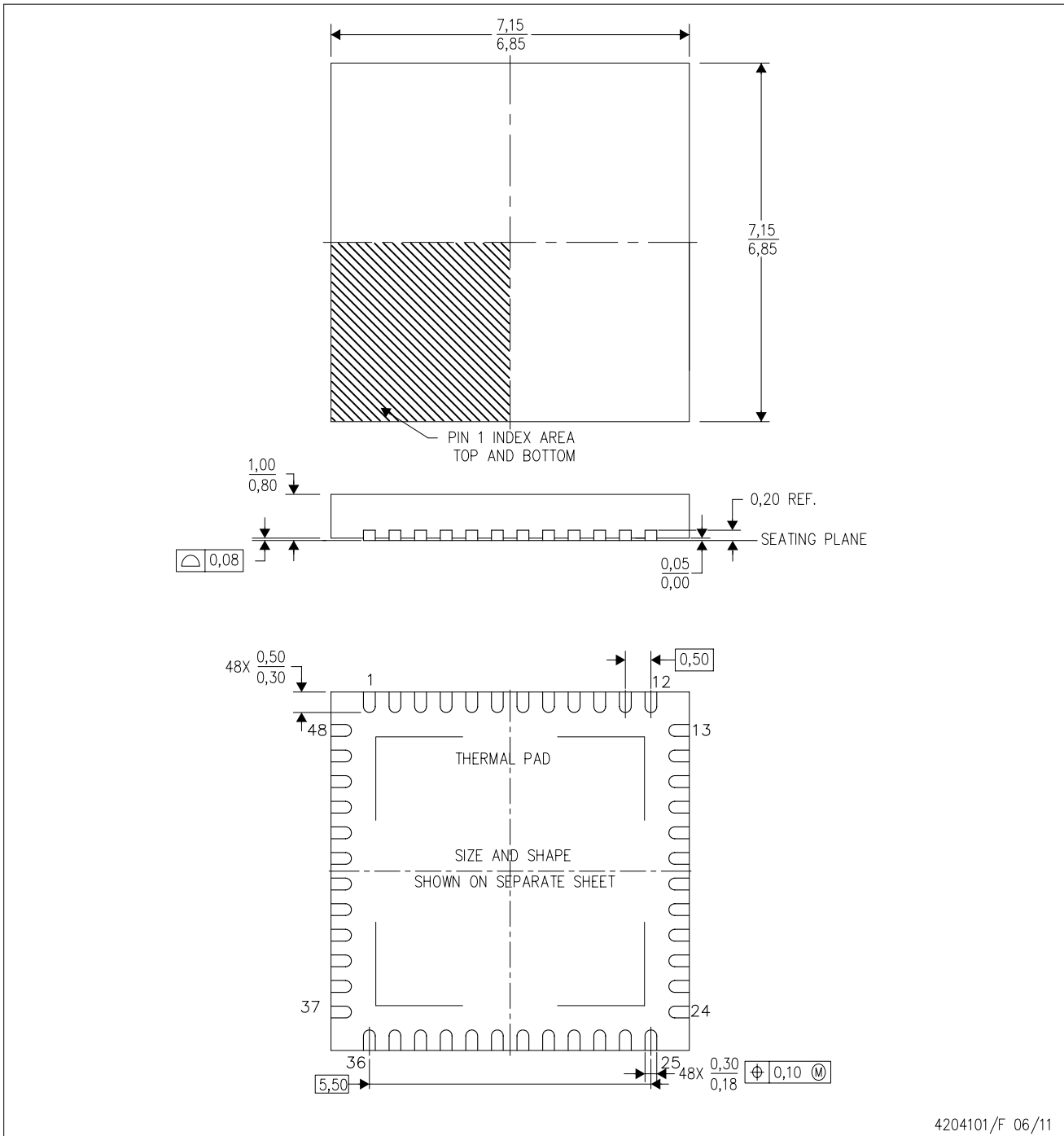

- NOTES:
- A. All linear dimensions are in millimeters. Dimensioning and tolerancing per ASME Y14.5M-1994.
  - B. This drawing is subject to change without notice.
  - C. Quad Flatpack, No-leads (QFN) package configuration.
  - D. The package thermal pad must be soldered to the board for thermal and mechanical performance.
  - E. See the additional figure in the Product Data Sheet for details regarding the exposed thermal pad features and dimensions.
  - F. Falls within JEDEC MO-220.

**THERMAL INFORMATION**

This package incorporates an exposed thermal pad that is designed to be attached directly to an external heatsink. The thermal pad must be soldered directly to the printed circuit board (PCB). After soldering, the PCB can be used as a heatsink. In addition, through the use of thermal vias, the thermal pad can be attached directly to the appropriate copper plane shown in the electrical schematic for the device, or alternatively, can be attached to a special heatsink structure designed into the PCB. This design optimizes the heat transfer from the integrated circuit (IC).

For information on the Quad Flatpack No-Lead (QFN) package and its advantages, refer to Application Report, QFN/SON PCB Attachment, Texas Instruments Literature No. SLUA271. This document is available at [www.ti.com](http://www.ti.com).

The exposed thermal pad dimensions for this package are shown in the following illustration.

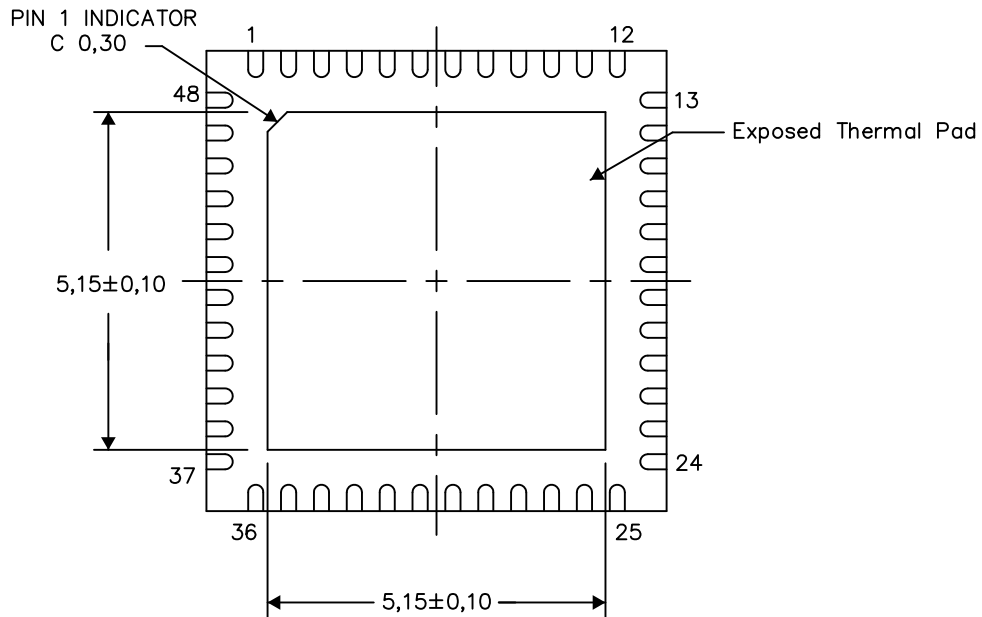

Bottom View

Exposed Thermal Pad Dimensions

4206354-2/X 01/14

NOTE: All linear dimensions are in millimeters

RGZ (S-PVQFN-N48)

PLASTIC QUAD FLATPACK NO-LEAD

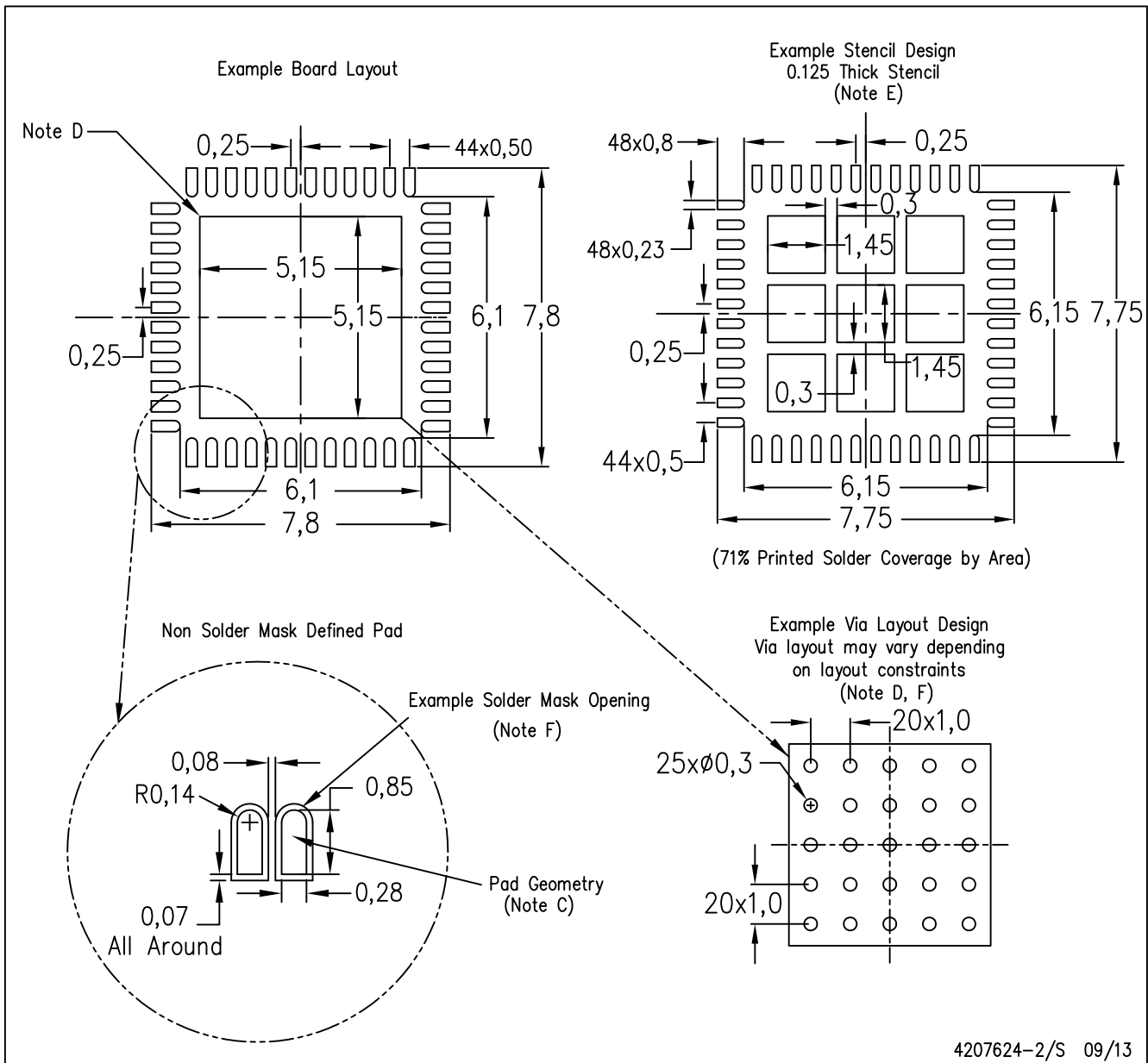

- NOTES:
- All linear dimensions are in millimeters.
  - This drawing is subject to change without notice.
  - Publication IPC-7351 is recommended for alternate designs.
  - This package is designed to be soldered to a thermal pad on the board. Refer to Application Note, Quad Flat-Pack Packages, Texas Instruments Literature No. SLUA271, and also the Product Data Sheets for specific thermal information, via requirements, and recommended board layout. These documents are available at [www.ti.com](http://www.ti.com) <<http://www.ti.com>>.
  - Laser cutting apertures with trapezoidal walls and also rounding corners will offer better paste release. Customers should contact their board assembly site for stencil design recommendations. Refer to IPC 7525 for stencil design considerations.
  - Customers should contact their board fabrication site for recommended solder mask tolerances and via tenting recommendations for vias placed in the thermal pad.

## IMPORTANT NOTICE

Texas Instruments Incorporated and its subsidiaries (TI) reserve the right to make corrections, enhancements, improvements and other changes to its semiconductor products and services per JESD46, latest issue, and to discontinue any product or service per JESD48, latest issue. Buyers should obtain the latest relevant information before placing orders and should verify that such information is current and complete. All semiconductor products (also referred to herein as "components") are sold subject to TI's terms and conditions of sale supplied at the time of order acknowledgment.

TI warrants performance of its components to the specifications applicable at the time of sale, in accordance with the warranty in TI's terms and conditions of sale of semiconductor products. Testing and other quality control techniques are used to the extent TI deems necessary to support this warranty. Except where mandated by applicable law, testing of all parameters of each component is not necessarily performed.

TI assumes no liability for applications assistance or the design of Buyers' products. Buyers are responsible for their products and applications using TI components. To minimize the risks associated with Buyers' products and applications, Buyers should provide adequate design and operating safeguards.

TI does not warrant or represent that any license, either express or implied, is granted under any patent right, copyright, mask work right, or other intellectual property right relating to any combination, machine, or process in which TI components or services are used. Information published by TI regarding third-party products or services does not constitute a license to use such products or services or a warranty or endorsement thereof. Use of such information may require a license from a third party under the patents or other intellectual property of the third party, or a license from TI under the patents or other intellectual property of TI.

Reproduction of significant portions of TI information in TI data books or data sheets is permissible only if reproduction is without alteration and is accompanied by all associated warranties, conditions, limitations, and notices. TI is not responsible or liable for such altered documentation. Information of third parties may be subject to additional restrictions.

Resale of TI components or services with statements different from or beyond the parameters stated by TI for that component or service voids all express and any implied warranties for the associated TI component or service and is an unfair and deceptive business practice. TI is not responsible or liable for any such statements.

Buyer acknowledges and agrees that it is solely responsible for compliance with all legal, regulatory and safety-related requirements concerning its products, and any use of TI components in its applications, notwithstanding any applications-related information or support that may be provided by TI. Buyer represents and agrees that it has all the necessary expertise to create and implement safeguards which anticipate dangerous consequences of failures, monitor failures and their consequences, lessen the likelihood of failures that might cause harm and take appropriate remedial actions. Buyer will fully indemnify TI and its representatives against any damages arising out of the use of any TI components in safety-critical applications.

In some cases, TI components may be promoted specifically to facilitate safety-related applications. With such components, TI's goal is to help enable customers to design and create their own end-product solutions that meet applicable functional safety standards and requirements. Nonetheless, such components are subject to these terms.

No TI components are authorized for use in FDA Class III (or similar life-critical medical equipment) unless authorized officers of the parties have executed a special agreement specifically governing such use.

Only those TI components which TI has specifically designated as military grade or "enhanced plastic" are designed and intended for use in military/aerospace applications or environments. Buyer acknowledges and agrees that any military or aerospace use of TI components which have **not** been so designated is solely at the Buyer's risk, and that Buyer is solely responsible for compliance with all legal and regulatory requirements in connection with such use.

TI has specifically designated certain components as meeting ISO/TS16949 requirements, mainly for automotive use. In any case of use of non-designated products, TI will not be responsible for any failure to meet ISO/TS16949.

### Products

Audio	<a href="http://www.ti.com/audio">www.ti.com/audio</a>
Amplifiers	<a href="http://amplifier.ti.com">amplifier.ti.com</a>
Data Converters	<a href="http://dataconverter.ti.com">dataconverter.ti.com</a>
DLP® Products	<a href="http://www.dlp.com">www.dlp.com</a>
DSP	<a href="http://dsp.ti.com">dsp.ti.com</a>
Clocks and Timers	<a href="http://www.ti.com/clocks">www.ti.com/clocks</a>
Interface	<a href="http://interface.ti.com">interface.ti.com</a>
Logic	<a href="http://logic.ti.com">logic.ti.com</a>
Power Mgmt	<a href="http://power.ti.com">power.ti.com</a>
Microcontrollers	<a href="http://microcontroller.ti.com">microcontroller.ti.com</a>
RFID	<a href="http://www.ti-rfid.com">www.ti-rfid.com</a>
OMAP Applications Processors	<a href="http://www.ti.com/omap">www.ti.com/omap</a>
Wireless Connectivity	<a href="http://www.ti.com/wirelessconnectivity">www.ti.com/wirelessconnectivity</a>

### Applications

Automotive and Transportation	<a href="http://www.ti.com/automotive">www.ti.com/automotive</a>
Communications and Telecom	<a href="http://www.ti.com/communications">www.ti.com/communications</a>
Computers and Peripherals	<a href="http://www.ti.com/computers">www.ti.com/computers</a>
Consumer Electronics	<a href="http://www.ti.com/consumer-apps">www.ti.com/consumer-apps</a>
Energy and Lighting	<a href="http://www.ti.com/energy">www.ti.com/energy</a>
Industrial	<a href="http://www.ti.com/industrial">www.ti.com/industrial</a>
Medical	<a href="http://www.ti.com/medical">www.ti.com/medical</a>
Security	<a href="http://www.ti.com/security">www.ti.com/security</a>
Space, Avionics and Defense	<a href="http://www.ti.com/space-avionics-defense">www.ti.com/space-avionics-defense</a>
Video and Imaging	<a href="http://www.ti.com/video">www.ti.com/video</a>

### TI E2E Community

[e2e.ti.com](http://e2e.ti.com)