

4.5-V to 14-V Input High-Current Synchronous Buck Converter

Check for Samples: [TPS56121](#)

FEATURES

- 4.5-V to 14-V Input Voltage Range
- Incorporates Power Block Technology
- Up to 15-A Output Current
- Fixed Frequency Options of 300 kHz, 500 kHz and 1 MHz
- High-Side and Low-Side MOSFET $R_{DS(on)}$ Sensing
- Programmable Soft-Start
- 600-mV Reference Voltage with 1% Accuracy
- Voltage Mode Control with Feed-Forward
- Supports Pre-Biased Output
- Thermal Shutdown
- 22-Pin 5 mm x 6 mm PQFN PowerPAD™ Package

APPLICATIONS

- Point-of-Load (POL) Power Modules
- High Density DC-DC Converters for Telecom and Networking Applications

DESCRIPTION

TPS56121 is a high-efficiency and high-current synchronous buck converter designed to operate from a supply between 4.5 V and 14 V. The device is capable of producing an output voltage as low as 0.6 V at loads up to 15 A. Integrated NexFET™ Power MOSFETs provide a small foot print and ease of use.

The device implements a voltage-mode control with voltage feed-forward compensation that responds instantly to input voltage change.

TPS56121 is available in a thermally enhanced 22-pin PQFN (DQP) PowerPAD™ package.

The device offers design flexibility with a variety of user programmable functions, including soft-start, overcurrent protection (OCP) levels, and loop compensation. OCP levels are programmed by a single external resistor connected from the ILIM pin to the circuit ground. During the initial power-on sequence, the device enters a calibration cycle, measures the voltage at the ILIM pin, and sets an internal OCP voltage level. During operation, the programmed OCP voltage level is compared to the voltage drop across the low-side FET when it is on to determine whether there is an overcurrent condition. It then enters a shutdown/restart cycle until the fault is removed.

SIMPLIFIED APPLICATION

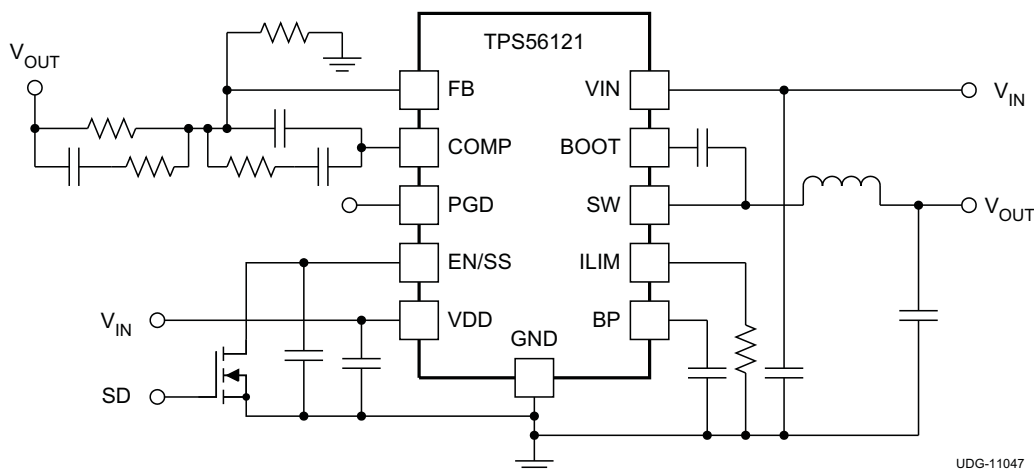

UDG-11047



Please be aware that an important notice concerning availability, standard warranty, and use in critical applications of Texas Instruments semiconductor products and disclaimers thereto appears at the end of this data sheet.

PowerPAD, NexFET are trademarks of Texas Instruments.

TPS56121

SLUSAH4B – MARCH 2011 – REVISED MARCH 2013

www.ti.com



These devices have limited built-in ESD protection. The leads should be shorted together or the device placed in conductive foam during storage or handling to prevent electrostatic damage to the MOS gates.

ORDERING INFORMATION

T _A	PACKAGE	PINS	TRANSPORT MEDIA	MINIMUM QUANTITY	ORDERABLE NUMBER
-40°C to 150°C	Plastic QFN (DQP)	22	Tape-and-reel	250	TPS56121DQPT
				2500	TPS56121DQPR

ABSOLUTE MAXIMUM RATINGS

over operating free-air temperature range (unless otherwise noted) ⁽¹⁾

		VALUE		UNIT
		MIN	TYP	
Voltage Range	VDD, VIN	-0.3	16.5	V
	SW	-3	25	
	SW (< 100 ns pulse width, 10 μJ)	-5		
	BOOT	-0.3	30	
	BOOT-SW (differential from BOOT to SW)	-0.3	7	
	COMP, PGOOD, FB, BP, EN/SS, ILIM	-0.3	7	
Electrostatic discharge	(HBM) QSS 009-105 (JESD22-A114A)		2	kV
	(CBM) QSS 009-147 (JESD22-C101B.01)		1.5	
Temperature	Junction, T _J	-40	150	°C
	Storage, T _{stg}	-55	150	

(1) Stresses beyond those listed under *Absolute Maximum Ratings* may cause permanent damage to the device. These are stress ratings only and functional operation of the device at these or any other condition beyond those included under *Recommended Operating Conditions* is not implied. Exposure to absolute-maximum-rated conditions for extended periods of time may affect device reliability.

THERMAL INFORMATION

THERMAL METRIC ⁽¹⁾		TPS56121	UNITS
		PQFN	
		22 PINS	
θ _{JA}	Junction-to-ambient thermal resistance	34.6	°C/W
θ _{JCtop}	Junction-to-case (top) thermal resistance	22.9	
ψ _{JT}	Junction-to-top characterization parameter	0.6	
ψ _{JB}	Junction-to-board characterization parameter	5.0	
θ _{JCbot}	Junction-to-case (bottom) thermal resistance	0.3	

(1) For more information about traditional and new thermal metrics, see the *IC Package Thermal Metrics* application report, [SPRA953](#).

RECOMMENDED OPERATING CONDITIONS

over operating free-air temperature range (unless otherwise noted)

		MIN	TYP	MAX	UNIT
V _{DD}	VIN Input voltage	4.5		14	V
T _J	Operating junction temperature	-40		125	°C

ELECTRICAL CHARACTERISTICS

–40°C ≤ T_J ≤ 125°C, V_{VDD} = 12 V, all parameters at zero power dissipation (unless otherwise noted)

PARAMETER		TEST CONDITIONS	MIN	TYP	MAX	UNITS
VOLTAGE REFERENCE						
V _{FB}	FB input voltage	T _J = 25°C, 4.5 V ≤ V _{VDD} ≤ 14 V	597	600	603	mV
		–40°C ≤ T _J ≤ 125°C, 4.5 V ≤ V _{VDD} ≤ 14 V	594	600	606	
INPUT SUPPLY						
V _{VDD}	Input supply voltage range		4.5		14	V
I _{VDDSD}	Shutdown supply current	V _{EN/SS} = 0.2 V		80	120	μA
I _{VDDQ}	Quiescent, non-switching	Let EN/SS float, V _{FB} = 1 V		2.5	5.0	mA
V _{UVLO}	UVLO ON Voltage		4.0		4.3	V
V _{UVLO(HYS)}	UVLO hysteresis		500		700	mV
ENABLE/SOFT-START						
V _{IH}	High-level input voltage, EN/SS		0.55	0.70	1.00	V
V _{IL}	Low-level input voltage, EN/SS		0.27	0.30	0.33	V
I _{SS}	Soft-start source current		8	10	12	μA
V _{SS}	Soft-start voltage level – Start of ramp		0.4	0.8	1.3	V
BP REGULATOR						
V _{BP}	Output voltage	I _{BP} = 10 mA	6.2	6.5	6.8	V
V _{DO}	Regulator dropout voltage, V _{VDD} – V _{BP}	I _{BP} = 25 mA, V _{VDD} = 4.5 V		70	125	mV
OSCILLATOR						
f _{SW}	Switching Frequency	R _{COMP} = 40.2 kΩ, 4.5 V ≤ V _{VDD} ≤ 14 V	270	300	330	kHz
		R _{COMP} = open, 4.5 V ≤ V _{VDD} ≤ 14 V	450	500	550	
		R _{COMP} = 13.3 kΩ, 4.5 V ≤ V _{VDD} ≤ 14 V	0.8	0.95	1.1	
V _{RAMP} ⁽¹⁾	Ramp amplitude		V _{VDD} /6.6	V _{VDD} /6	V _{VDD} /5.4	V
PWM						
D _{MAX} ⁽¹⁾	Maximum duty cycle	f _{sw} = 300 kHz, V _{FB} = 0 V, 4.5 V ≤ V _{VDD} ≤ 14 V	93%			
		f _{sw} = 500 kHz, V _{FB} = 0 V, 4.5 V ≤ V _{VDD} ≤ 14 V	90%			
		f _{sw} = 1 MHz, V _{FB} = 0 V, 4.5 V ≤ V _{VDD} ≤ 14 V	85%			
t _{ON(min)} ⁽¹⁾	Minimum controllable pulse width				100	ns
ERROR AMPLIFIER						
GBWP ⁽¹⁾	Gain bandwidth product		10	24		MHz
A _{OL} ⁽¹⁾	Open loop gain		60			dB
I _{IB}	Input bias current (current out of FB pin)	V _{FB} = 0.6 V			75	nA
I _{EAOP}	Output source current	V _{FB} = 0 V	1.5			mA
I _{EAOM}	Output sink current	V _{FB} = 1 V	1.5			mA

(1) Ensured by design. Not production tested

TPS56121

SLUSAH4B – MARCH 2011 – REVISED MARCH 2013

www.ti.com
ELECTRICAL CHARACTERISTICS (continued)
 $-40^{\circ}\text{C} \leq T_J \leq 125^{\circ}\text{C}$, $V_{\text{VDD}} = 12\text{ V}$, all parameters at zero power dissipation (unless otherwise noted)

PARAMETER		TEST CONDITIONS	MIN	TYP	MAX	UNITS
POWER GOOD						
V_{OV}	Feedback upper voltage limit for PGOOD		655	675	700	mV
V_{UV}	Feedback lower voltage limit for PGOOD		500	525	550	
$V_{\text{PGD-HYST}}$	PGOOD hysteresis voltage at FB			30	45	
R_{PGD}	PGOOD pull down resistance	$V_{\text{FB}} = 0\text{ V}$, $I_{\text{FB}} = 5\text{ mA}$		30	70	Ω
I_{PGDLK}	PGOOD leakage current	$550\text{ mV} < V_{\text{FB}} < 655\text{ mV}$, $V_{\text{PGOOD}} = 5\text{ V}$		10	20	μA
OUTPUT STAGE						
R_{HI}	High-side device resistance	$T_J = 25^{\circ}\text{C}$, $(V_{\text{BOOT}} - V_{\text{SW}}) = 5.5\text{ V}$		4.5	6.5	m Ω
R_{LO}	Low side device resistance	$T_J = 25^{\circ}\text{C}$		1.9	2.7	
OVERCURRENT PROTECTION (OCP)						
$t_{\text{PSSC(min)}}$ ⁽²⁾	Minimum pulse time during short circuit			250		ns
t_{BLNKH} ⁽²⁾	Switch leading-edge blanking pulse time (high-side detection)			150		
I_{OCH}	OC threshold for high-side FET	$T_J = 25^{\circ}\text{C}$, $(V_{\text{BOOT}} - V_{\text{SW}}) = 5.5\text{ V}$	27	34	39	A
I_{ILIM}	ILIM current source	$T_J = 25^{\circ}\text{C}$		10.0		μA
V_{OCLPRO} ⁽²⁾	Programmable OC range for low side FET	$T_J = 25^{\circ}\text{C}$	12		100	mV
t_{OFF}	OC retry cycles on EN/SS pin			4		Cycle
BOOT DIODE						
V_{DFWD}	Bootstrap diode forward voltage	$I_{\text{BOOT}} = 5\text{ mA}$		0.8		V
THERMAL SHUTDOWN						
T_{JSD} ⁽²⁾	Junction shutdown temperature			145		$^{\circ}\text{C}$
T_{JSDH} ⁽²⁾	Hysteresis			20		$^{\circ}\text{C}$

(2) Ensured by design. Not production tested

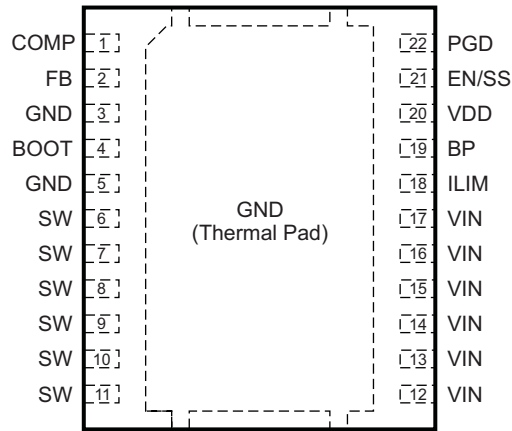
DEVICE INFORMATION
**DQP PACKAGE
PQFN-22
(TOP VIEW)**

Note: The thermal pad is also an electrical ground connection.

PIN FUNCTIONS

PIN		I/O	DESCRIPTION
NAME	NO.		
BOOT	4	O	Gate drive voltage for the high-side FET. A 100-nF capacitor (typical) must be connected between this pin and the SW pin. To reduce a voltage spike at SW, a BOOT resistor with a value between 5 Ω to 15 Ω may be placed in series with the BOOT capacitor to slow down turn-on of the high-side FET.
BP	19	O	Output bypass for the internal regulator. Connect a low-ESR bypass ceramic capacitor of 1 μ F or greater from this pin to GND.
COMP	1	O	Output of the error amplifier and connection node for loop feedback components. Optionally, a 40.2 k Ω resistor from this pin to GND sets switching frequency to 300KHz instead of the default value of 500 kHz; while a 13.3-k Ω resistor from this pin to GND sets switching frequency to 1 MHz.
EN/SS	21	I	Logic-level input starts or stops the controller via an external user command. Allowing this pin to float turns the controller on. Pulling this pin low disables the controller. This is also the soft-start programming pin. A capacitor connected from this pin to GND programs the soft-start time. The capacitor is charged with an internal current source of 10 μ A. The resulting voltage ramp of this pin is also used as a second non-inverting input to the error amplifier after a 0.8 V (typical) level shift downwards. Output regulation is controlled by the internal level shifted voltage ramp until that voltage reaches the internal reference voltage of 600 mV. The voltage ramp of this pin reaches 1.4 V (typical).
FB	2	I	Inverting input to the error amplifier. In normal operation, the voltage on this pin is equal to the internal reference voltage.
GND	3	-	Ground reference for the device
	5		
GND	Thermal Pad	-	Ground reference for the device. This is also the thermal pad used to conduct heat from the device. This connection serves two purposes. The first is to provide an electrical ground connection for the device. The second is to provide a low thermal impedance path from the device die to the PCB. This pad should be tied externally to a ground plane.
ILIM	18	I	A resistor connected from this pin to GND sets the overcurrent threshold for the device (the low-side FET).

TPS56121

SLUSAH4B – MARCH 2011 – REVISED MARCH 2013

www.ti.com

PIN FUNCTIONS (continued)

PIN	I/O	DESCRIPTION	
NAME	NO.		
PGD	22	O	Open drain power good output.
SW	6	I	Switching node of the power conversion stage. Sense line for the adaptive anti-cross conduction circuitry. Acts as the common connection for the flying high-side FET driver.
	7		
	8		
	9		
	10		
VDD	20	I	Power input to the controller. A low-ESR bypass ceramic capacitor of 1 μ F should be connected from this pin close to GND.
VIN	12	I	Power input to the high-side FET.
	13		
	14		
	15		
	16		
	17		

FUNCTIONAL BLOCK DIAGRAM

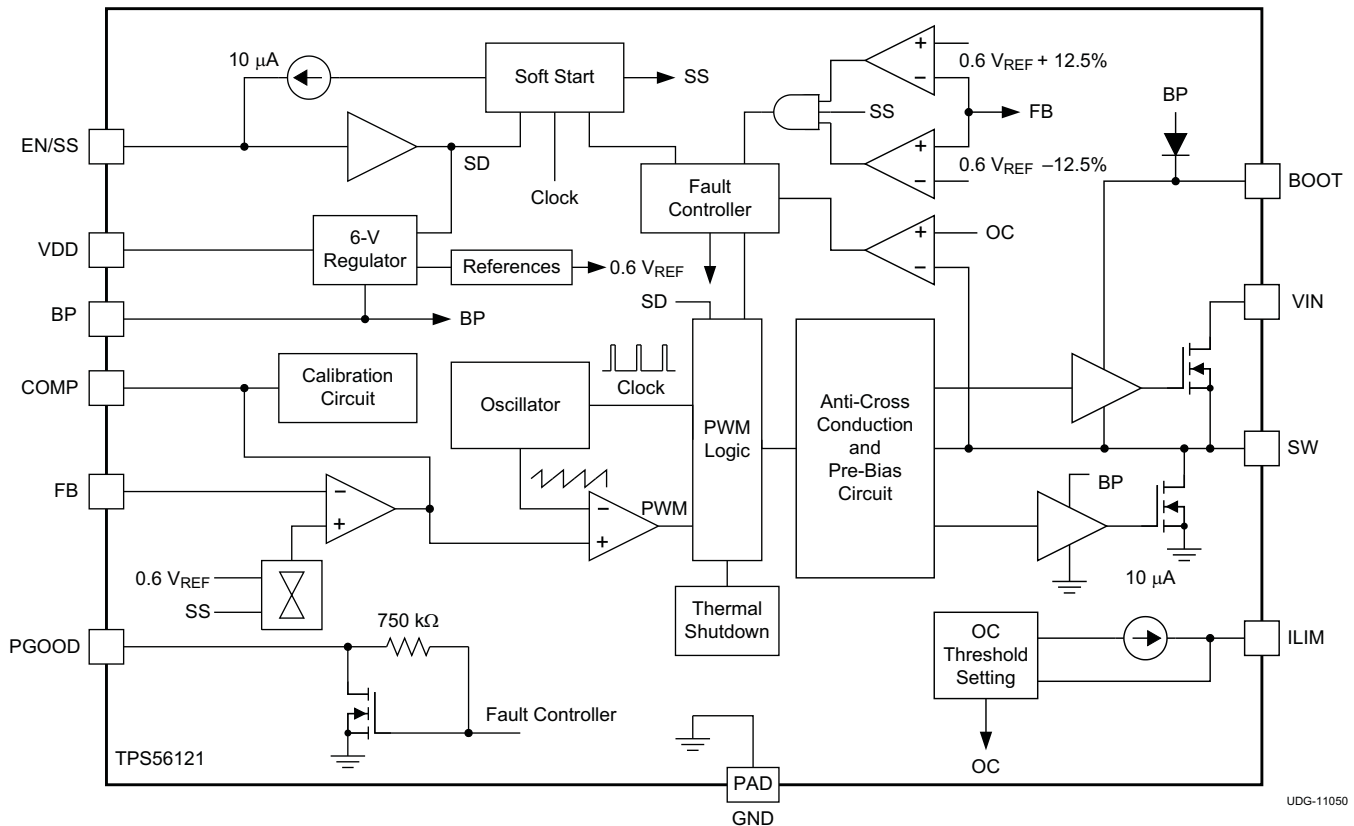

UDG-11050

TYPICAL CHARACTERISTICS

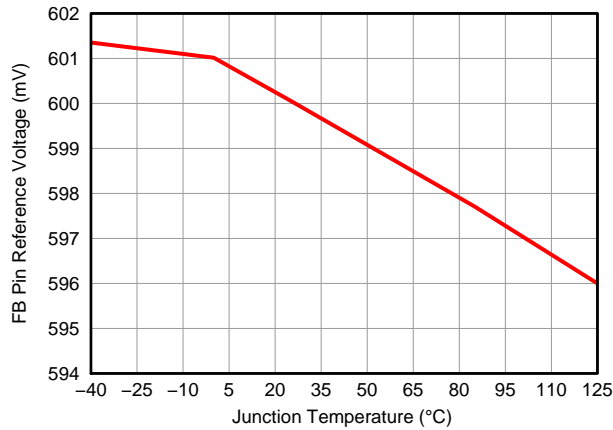

Figure 1. Reference Voltage vs. Junction Temperature

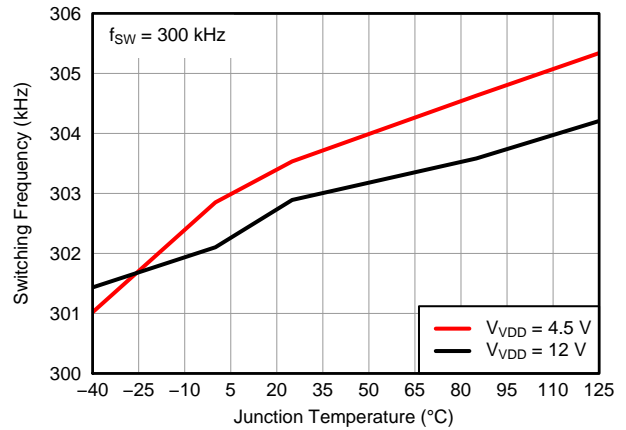

Figure 2. Switching Frequency vs. Junction Temperature (300 kHz)

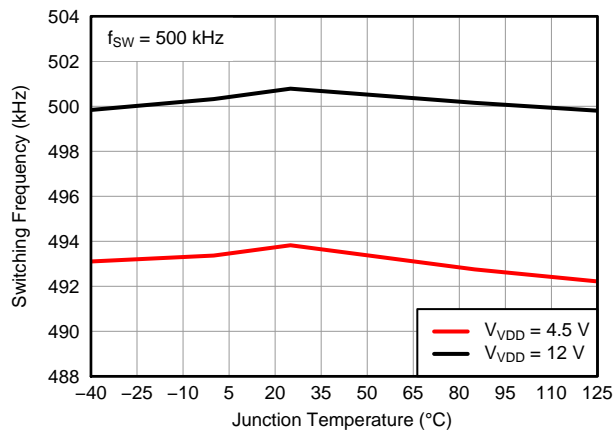

Figure 3. Switching Frequency vs. Junction Temperature (500 kHz)

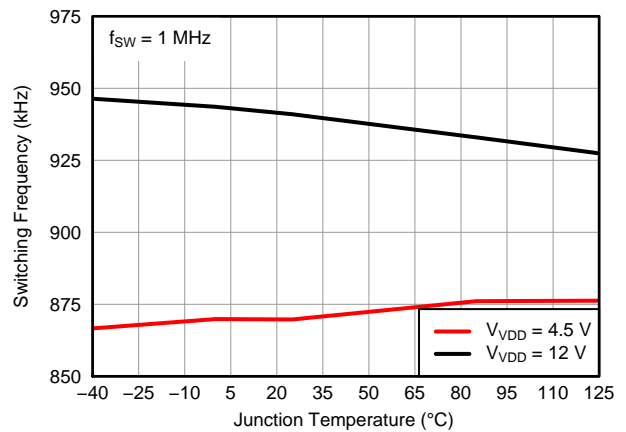

Figure 4. Switching Frequency vs. Junction Temperature (1 MHz)

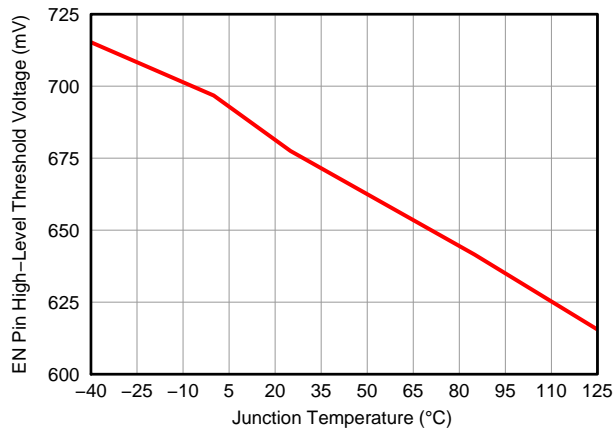

Figure 5. EN Pin High-Level Threshold Voltage vs. Junction Temperature

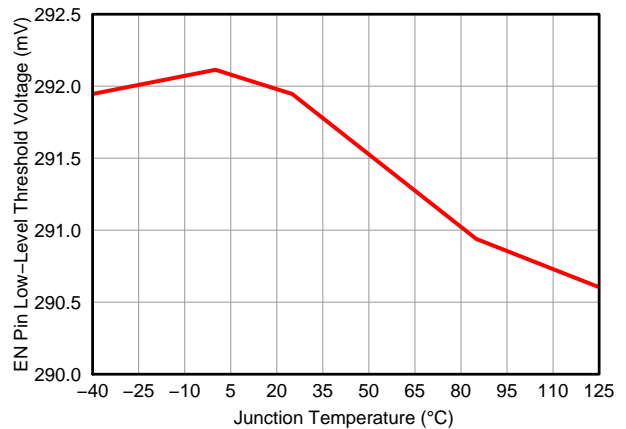

Figure 6. EN Pin Low-Level Threshold Voltage vs. Junction Temperature

TYPICAL CHARACTERISTICS (continued)

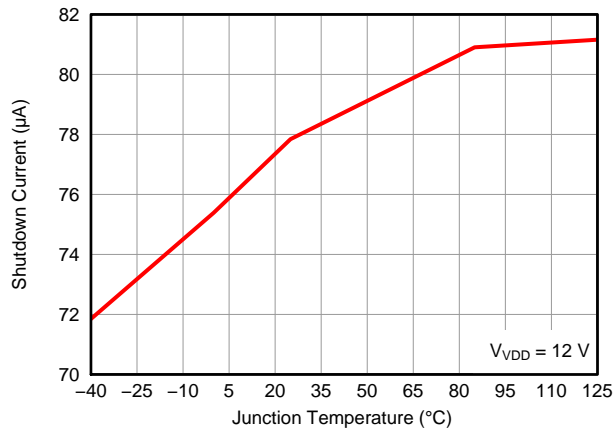

Figure 7. Shutdown Current vs. Junction Temperature

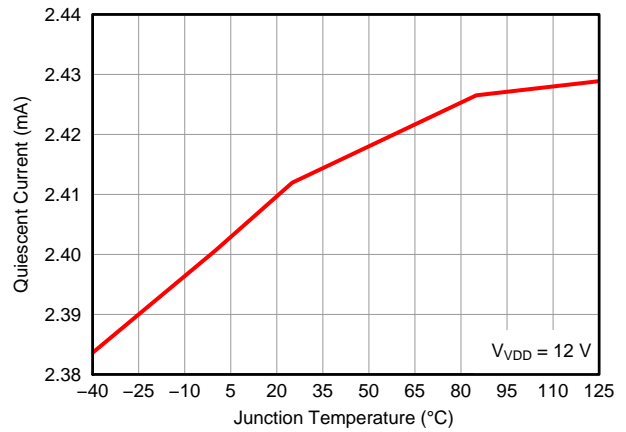

Figure 8. Quiescent Current vs. Junction Temperature

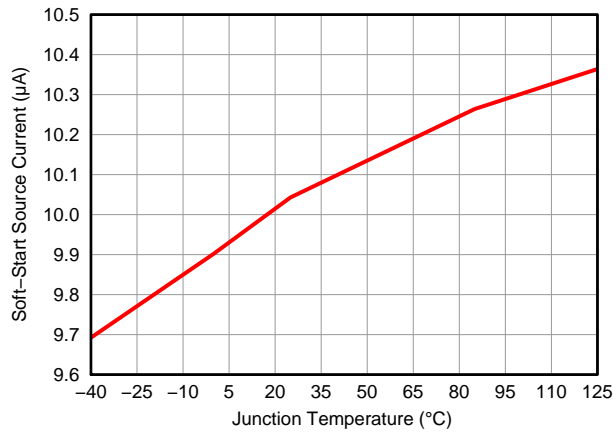

Figure 9. Soft-Start Source vs. Junction Temperature

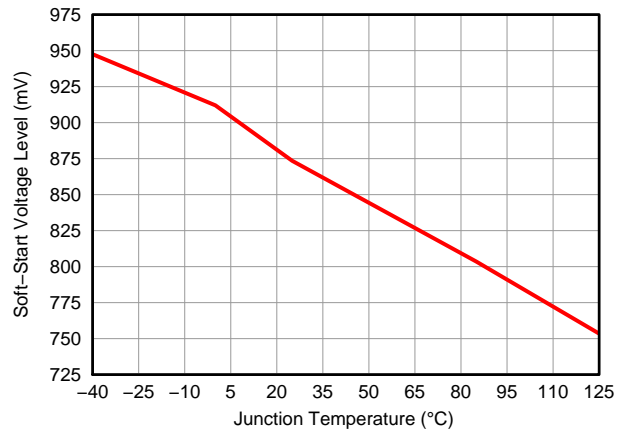

Figure 10. Soft-Start Voltage Level vs. Junction Temperature

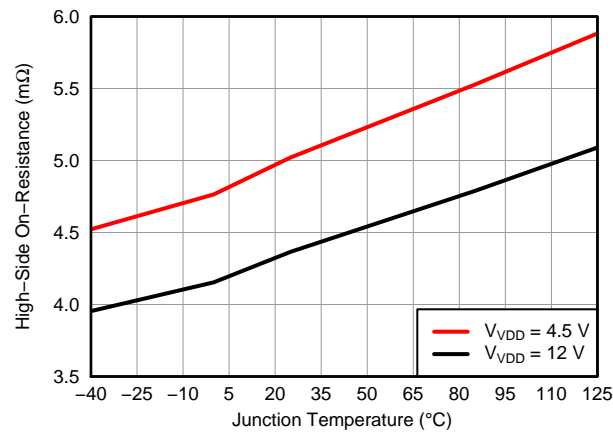

Figure 11. High-Side On Resistance vs. Junction Temperature

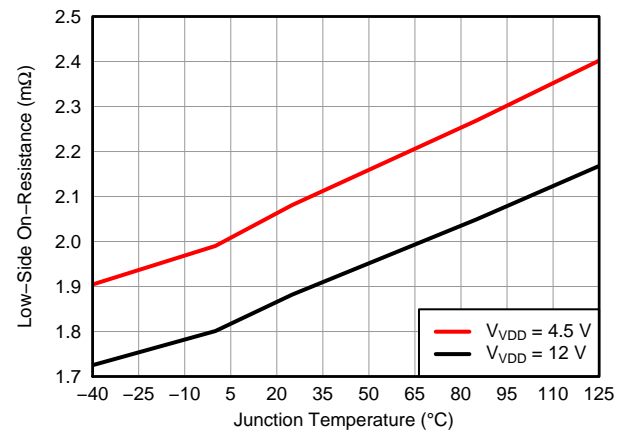

Figure 12. Low-Side On Resistance vs. Junction Temperature

TYPICAL CHARACTERISTICS

Figure 15 through Figure 18 are measured on a 2.5" x 2.5" x 0.062" FR4 board with 4 layers and 2 oz. copper, a 0.44- μ H output inductor and a DCR of 0.32 m Ω .

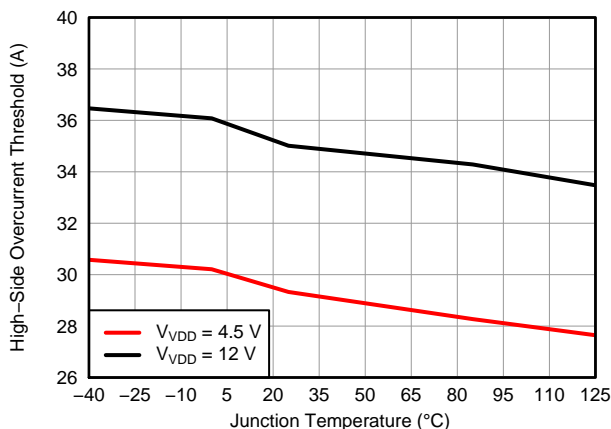

Figure 13. High-Side Overcurrent Threshold vs. Junction Temperature

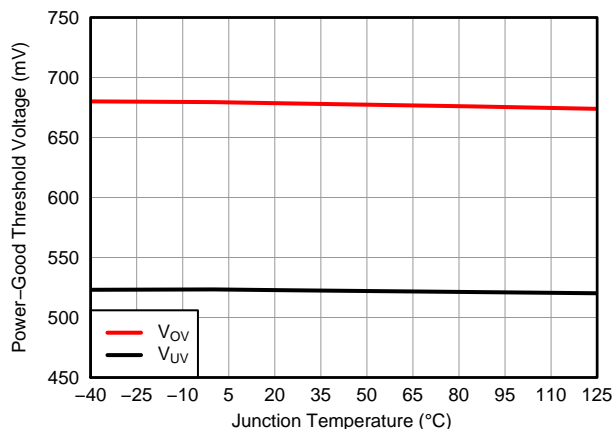

Figure 14. Power Good Threshold Voltage vs. Junction Temperature

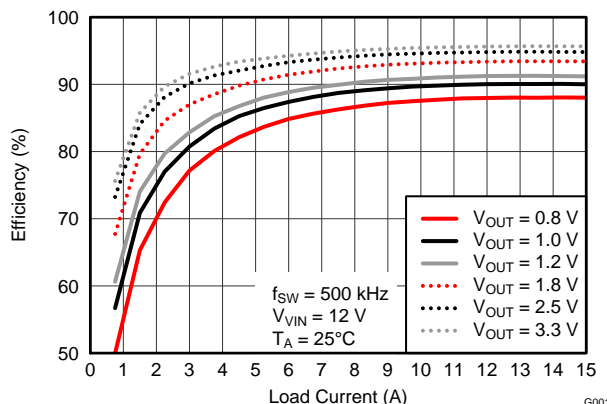

Figure 15. Efficiency vs. Load Current ($V_{IN} = 12 V$)

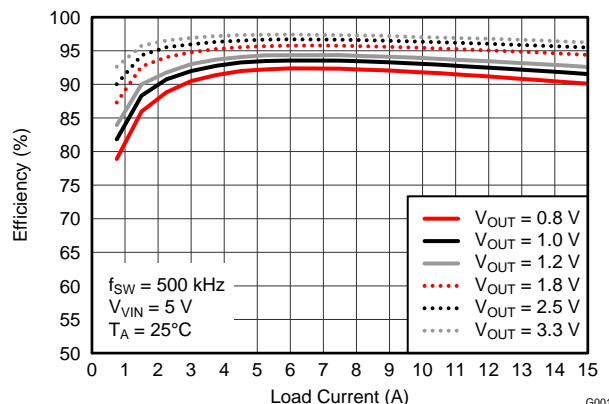

Figure 16. Efficiency vs. Load Current ($V_{IN} = 5 V$)

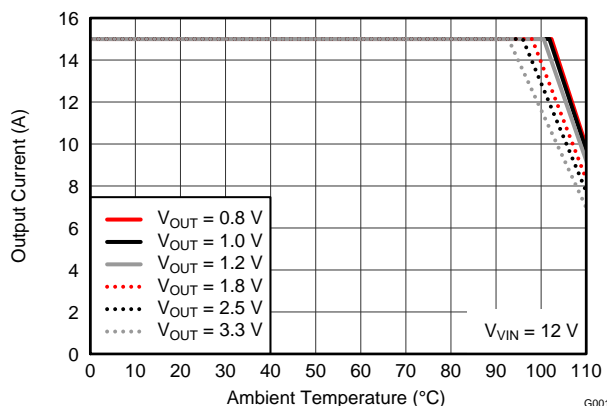

Figure 17. Output Current vs. Ambient Temperature ($V_{IN} = 12 V$)

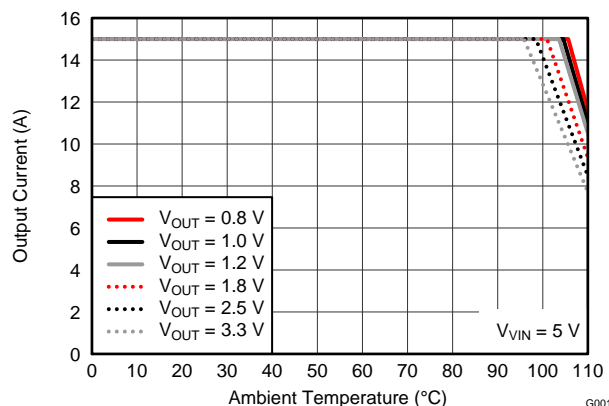

Figure 18. Output Current vs. Ambient Temperature ($V_{IN} = 5 V$)

APPLICATION INFORMATION

Introduction

The TPS56121 is a 15-A high performance synchronous buck converter with two integrated N-channel NexFET™ power MOSFETs. The device implements a voltage-mode control with voltage feed-forward compensation that responds instantly to input voltage change. Pre-bias capability eliminates concerns about damaging sensitive loads.

Voltage Reference

The 600-mV bandgap cell is internally connected to the non-inverting input of the error amplifier. The reference voltage is trimmed with the error amplifier in a unity gain configuration to remove amplifier offset from the final regulation voltage. The 1% tolerance on the reference voltage allows the user to design a very accurate power supply.

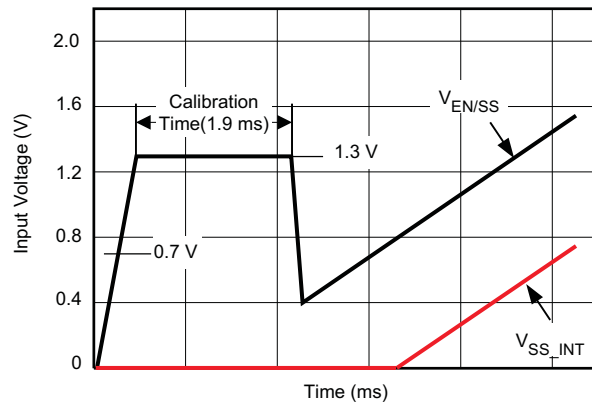

Figure 19. Startup Sequence and Timing

Enable Functionality, Startup Sequence and Timing

After input power is applied, an internal 40- μ A current source begins to charge the soft-start capacitor connected from EN/SS to GND. When the voltage across that capacitor increases to 0.7 V, it enables the internal BP regulator followed by a calibration. Total calibration time is approximately 1.9 ms. See Figure 19. During the calibration, the device performs the following two functions.

COMP Pin Impedance Sensing

The device samples the impedance at the COMP pin and determines the appropriate operating switching frequency. If there is no resistor connected from the COMP pin to GND, the switching frequency is set to the default value of 500 kHz. If a resistor of 40.2 k Ω \pm 10% is connected from the COMP pin to GND, the switching frequency is set to 300 kHz. Alternatively, if a resistor of 13.3 K \pm 10% is connected from the COMP pin to GND, the switching frequency is set to 1 MHz.

After a 1.1-ms time period, the COMP pin is then brought low for 0.8 ms. This ensures that the feedback loop is preconditioned at startup and no sudden output rise occurs at the output of the converter when it is allowed to start switching.

Overcurrent Protection (OCP) Setting

The device sources 10 μA (typical) to the resistor connected from the ILIM pin to GND. The voltage developed across that resistor multiplied by a factor of 2 is then sampled and latched off internally as the OCP trip level for the low-side FET until one cycles the input or toggles the EN/SS.

The voltage at EN/SS is internally clamped to 1.3 V before and/or during calibration to minimize the discharging time once calibration is complete. The discharging current is from an internal current source of 140 μA and it pulls the voltage down to 0.4 V. It then initiates the soft-start by charging up the capacitor using an internal current source of 10 μA . The resulting voltage ramp on this pin is used as a second non-inverting input to the error amplifier after an 800 mV (typical) downward level-shift; therefore, the actual soft-start does not take place until the voltage at this pin reaches 800 mV.

If the EN/SS pin is left floating, the controller starts automatically. EN/SS must be pulled down to less than 270 mV to ensure that the chip is in shutdown mode.

Soft-Start Time

The soft-start time of the TPS56121 is user programmable by selecting a single capacitor. The EN/SS pin sources 10 μA to charge this capacitor. The actual output ramp-up time is the amount of time that it takes for the 10 μA to charge the capacitor through a 600 mV range. There is some initial lag due to calibration and an offset (800 mV) from the actual EN/SS pin voltage to the voltage applied to the error amplifier.

The soft-start is accomplished in a closed-loop, meaning that the error amplifier controls the output voltage at all times during the soft-start period and the feedback loop is never open as occurs in duty cycle limit soft-start schemes. The error amplifier has two non-inverting inputs, one connected to the 600-mV reference voltage, and the other connected to the offset EN/SS pin voltage. The lower of these two voltages is what the error amplifier controls the FB pin to. As the voltage on the EN/SS pin ramps up past approximately 1.4 V (800 mV offset voltage plus the 600 mV reference voltage), the 600-mV reference voltage becomes the dominant input and the converter has reached its final regulation voltage.

The capacitance required for a given soft-start ramp time for the output voltage is calculated in [Equation 1](#).

$$C_{SS} = \left(\frac{I_{SS}}{V_{FB}} \right) \times t_{SS}$$

where

- C_{SS} is the required capacitance on the EN/SS pin (nF)
 - I_{SS} is the soft-start source current (10 μA)
 - V_{FB} is the feedback reference voltage (0.6 V)
 - t_{SS} is the desired soft-start ramp time (ms)
- (1)

Oscillator

The oscillator frequency is internally fixed at 500 KHz if there is no resistor connected from COMP pin to GND. Optionally, a 40.2-k Ω resistor from the COMP pin to GND sets the frequency to 300 KHz. Alternatively, a 13.3-k Ω resistor from COMP pin to GND sets the frequency to 1 MHz.

Overcurrent Protection (OCP)

Programmable OCP level at ILIM is from 6 mV to 50 mV. With a scale factor of 2, the actual OC trip point across the low-side FET is in the range of 12 mV to 100 mV.

If the voltage drop across R_{OCSET} reaches 300 mV during calibration (No R_{OCSET} resistor included), it disables OC protection. Once disabled, there is no low-side or high-side current sensing.

OCP level for the high-side FET is fixed at 34 A (typical). The high-side OCP provides pulse-by-pulse current limiting.

OCP sensing for the low-side FET is a true inductor valley current detection, using sample and hold. Equation 2 can be used to calculate R_{OCSET} . Since the TPS56121 is designed for 15-A full-load current and not intentionally designed for an OCP level below 10 A, use an R_{OCSET} value above 1 k Ω to get an accurate OCP tripping point.

$$R_{OCSET} = \left(I_{OUT(max)} - \left(\frac{I_{P-P}}{2} \right) \right) \times 95 + 62.5$$

where

- I_{P-P} is the peak-to-peak inductor current (A)
- $I_{OUT(max)}$ is the trip point for OCP (A)
- R_{OCSET} is the resistor used for setting the OCP level (Ω) (2)

An overcurrent (OC) condition is detected by sensing voltage drop across the low-side FET and across the high-side FET. If the voltage drop across either FET exceeds OC threshold, a count increments one count. If no OC condition is detected on either FET, the fault counter decrements by one counter. If three OC pulses are summed, a fault condition is declared which cycles the soft-start function in a hiccup mode. Hiccup mode is defined as four dummy soft-start timeouts followed by a real one if overcurrent condition is encountered during normal operation; or five dummy soft-start timeouts followed by a real one if overcurrent condition occurs from the beginning during start. This cycle continues indefinitely until the fault condition is removed.

Switching Node (SW)

The SW pin connects to the switching node of the power conversion stage. It acts as the return path for the high-side gate driver. When configured as a synchronous buck stage, the voltage swing on SW normally traverses from below ground to well above the input voltage. Parasitic inductance in the high-side FET and the output capacitance (C_{OSS}) of both power FETs form a resonant circuit that can produce high frequency (> 100 MHz) ringing on this node. The voltage peak of this ringing, if not controlled, can be significantly higher than the input voltage. Ensure that the peak ringing amplitude does not exceed the absolute maximum rating limit for the pin.

In many cases, a series resistor and capacitor snubber network connected from the switching node to PGND can be helpful in damping the ringing and decreasing the peak amplitude. Provide provisions for snubber network components in the layout of the printed circuit board. If testing reveals that the ringing amplitude at the SW pin exceeds the limit, then include snubber components.

Placing a BOOT resistor with a value between 5 Ω and 15 Ω in series with the BOOT capacitor slows down the turn-on of the high-side FET and can help to reduce the peak ringing at the switching node as well.

Input Undervoltage Lockout (UVLO)

The TPS56121 has fixed input under-voltage lockout (UVLO). In order for the device to turn on, the following conditions must be met:

- the EN/SS pin voltage must be greater than V_{IH}
- the input voltage must exceed UVLO on voltage V_{UVLO}

The UVLO has a minimum of 500 mV hysteresis built-in.

Pre-Bias Startup

The TPS56121 contains a unique circuit to prevent current from being pulled from the output during startup in the condition the output is pre-biased. There are no PWM pulses until the internal soft-start voltage rises above the error amplifier input (FB pin), if the output is pre-biased. Once the soft-start voltage exceeds the error amplifier input, the controller slowly initiates synchronous rectification by starting the synchronous rectifier with a narrow on time. It then increments the on-time on a cycle-by-cycle basis until it coincides with the time dictated by $(1-D)$, where D is the duty cycle of the converter.

This approach prevents the sinking of current from a pre-biased output, and ensures the output voltage startup and ramp to regulation is smooth and controlled.

Power Good

The TPS56121 provides an indication that output is good for the converter. This is an open drain signal and pulls low when any condition exists that would indicate that the output of the supply might be out of regulation. These conditions include:

- V_{FB} is more than $\pm 12.5\%$ from nominal
- soft-start is active
- a short circuit condition has been detected

NOTE

When there is no power to the device, PGOOD is not able to pull close to GND if an auxiliary supply is used for the power good indication. In this case, a built in resistor connected from drain to gate on the PGOOD pull down device makes the PGOOD pin look approximately like a diode to GND.

Thermal Shutdown

If the junction temperature of the device reaches the thermal shutdown limit of 145°C , both the high-side FET and low-side FET maintain off status. When the junction cools to the required level (125°C typical), the PWM initiates soft start as during a normal power-up cycle.

DESIGN EXAMPLE

Introduction

This design example describes a 15-A, 12-V to 1.0-V design using the TPS56121 high-current integrated buck converter. The system specifications are listed in [Table 1](#).

Table 1. TPS56121 Design Example Parameters

PARAMETER		TEST CONDITIONS	MIN	TYP	MAX	UNIT
V_{IN}	Input voltage		8	12	14	V
$V_{IN(ripple)}$	Input ripple	$I_{OUT} = 15\text{ A}$			0.15	V
V_{OUT}	Output voltage	$0\text{ A} \leq I_{OUT} \leq 15\text{ A}$	0.98	1.00	1.02	V
	Line regulation	$8\text{ V} \leq V_{IN} \leq 14\text{ V}$			0.1%	
	Load regulation	$0\text{ A} \leq I_{OUT} \leq 15\text{ A}$			0.5%	
V_{RIPPLE}	Output ripple	$I_{OUT} = 15\text{ A}$		20		mV
V_{OVER}	Output overshoot	$I_{TRAN} = 5\text{ A}$		50		mV
V_{UNDER}	Output undershoot	$I_{TRAN} = 5\text{ A}$		50		mV
I_{OUT}	Output current	$8\text{ V} \leq V_{IN} \leq 14\text{ V}$	0		15	A
t_{SS}	Soft-start time	$V_{IN} = 12\text{ V}$		2.0		ms
$I_{OUT(max)}$	Short-circuit current trip point		20			A
η	Efficiency	$V_{IN} = 12\text{ V}, I_{OUT} = 15\text{ A}$		90		%
f_{SW}	Switching frequency			500		kHz

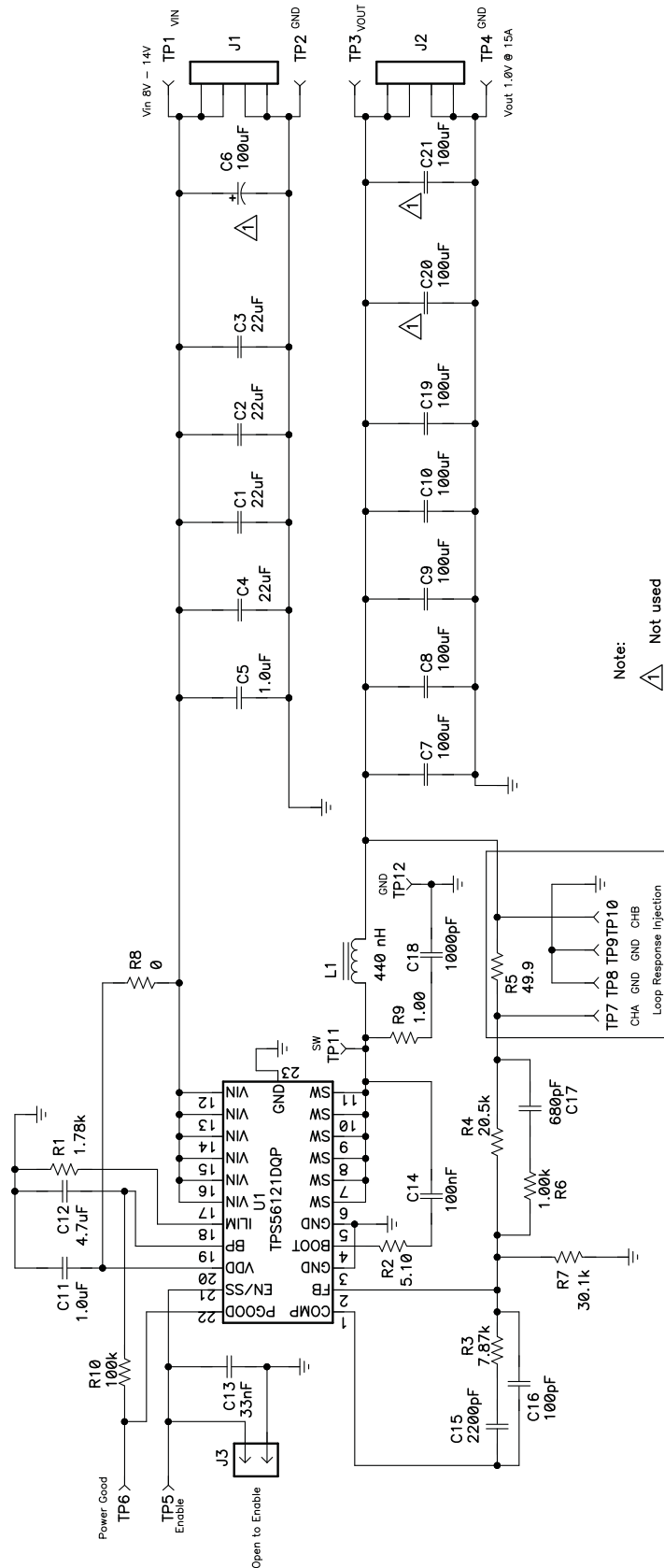

Figure 20. Design Example Schematic

Design Procedure

Switching Frequency Selection

To achieve a balance between small size and high efficiency for this design, use switching frequency of 500 kHz.

Inductor Selection (L1)

Synchronous buck power inductors are typically sized for between approximately 20% and 40% peak-to-peak ripple current (I_{P-P}).

Using this target ripple current, the required inductor size can be calculated as shown in [Equation 3](#).

$$L \approx \frac{V_{IN(max)} - V_{OUT}}{0.3 \times I_{OUT}} \times \frac{V_{OUT}}{V_{IN(max)}} \times \frac{1}{f_{SW}} = \frac{14V - 1.0V}{0.3 \times 15A} \times \frac{1.0V}{14V} \times \frac{1}{500kHz} = 413nH \quad (3)$$

Selecting a standard 440-nH inductor value, $I_{P-P} = 4.2$ A.

The RMS current through the inductor is approximated in [Equation 4](#).

$$I_{L(rms)} = \sqrt{(I_{OUT})^2 + \left(\frac{1}{12} \times (I_{P-P})^2\right)} = \sqrt{(15)^2 + \left(\frac{1}{12} \times (4.2)^2\right)} = 15.05A \quad (4)$$

Output Capacitor Selection

The output transient response typically drives the selection of the output capacitor. For applications where $V_{IN(min)} > 2 \times V_{OUT}$, use overshoot to calculate the minimum output capacitance, as shown in [Equation 5](#).

$$C_{OUT(min)} = \frac{(I_{TRAN})^2 \times L}{(V_{OUT} \times V_{OVER})} = \frac{5^2 \times 440nH}{1.0 \times 50mV} = 220\mu F \quad (5)$$

For applications where $V_{IN(min)} < 2 \times V_{OUT}$, use overshoot to calculate the minimum output capacitance. The equation is shown in [Equation 6](#)

$$C_{OUT(min)} = \frac{(I_{TRAN})^2 \times L}{(V_{IN} - V_{OUT}) \times V_{UNDER}} \quad (6)$$

In order to meet the low ESR and high capacitance requirements, this design uses five 100- μ F, 1210 ceramic capacitors. With a minimum capacitance, maximum ripple voltage determines the maximum allowable ESR. The ESR is approximated in [Equation 7](#).

$$ESR_{COUT(max)} = \frac{V_{RIPPLE} - V_{RIPPLE(COUT)}}{I_{P-P}} = \frac{V_{RIPPLE} - \left(\frac{I_{P-P}}{8 \times C_{OUT} \times f_{SW}}\right)}{I_{P-P}} = \frac{20mV - \left(\frac{4.2A}{8 \times 500\mu F \times 500kHz}\right)}{4.2A} = 4.3m\Omega \quad (7)$$

Inductor Peak Current Rating

With output capacitance, it is possible to calculate the charge current during start-up and determine the minimum saturation current rating for the inductor. Equation 8 approximates the start-up charging current (I_{CHARGE}).

$$I_{\text{CHARGE}} = \frac{V_{\text{OUT}} \times C_{\text{OUT}}}{t_{\text{SS}}} = \frac{1.0 \text{ V} \times 500 \mu\text{F}}{2 \text{ ms}} = 0.25 \text{ A} \quad (8)$$

Equation 9 approximates the peak current in the inductor, $I_{\text{L(peak)}}$.

$$I_{\text{L(peak)}} = I_{\text{OUT}} + \left(\frac{1}{2} \times I_{\text{RIPPLE}}\right) + I_{\text{CHARGE}} = 15 \text{ A} + \left(\frac{1}{2} \times 4.2 \text{ A}\right) + 0.25 \text{ A} = 17.4 \text{ A} \quad (9)$$

With the short circuit current trip point $I_{\text{OUT(max)}}$ set at 20 A, the maximum allowable peak current $I_{\text{L_PEAK(max)}}$ is shown in Equation 10.

$$I_{\text{L_PEAK(max)}} = I_{\text{OUT(max)}} + \left(\frac{1}{2} \times I_{\text{RIPPLE}}\right) = 20 \text{ A} + \left(\frac{1}{2} \times 4.2 \text{ A}\right) = 22.1 \text{ A} \quad (10)$$

The selection of output capacitor meets the maximum allowable peak current requirement.

Table 2. Inductor Requirements Summary

PARAMETER		VALUE	UNITS
L	Inductance	440	nH
$I_{\text{L(rms)}}$	RMS current (thermal rating)	15.1	A
$I_{\text{L_PEAK(max)}}$	Peak current (saturation rating)	22.1	A

This design uses a PA0513.441NLT, 440-nH, 0.32-m Ω , 30-A inductor.

Input Capacitor Selection

The input voltage ripple is divided between capacitance and ESR. For this design $V_{\text{IN_RIPPLE(CAP)}} = 100 \text{ mV}$ and $V_{\text{IN_RIPPLE(ESR)}} = 50 \text{ mV}$. Use Equation 11 to estimate the minimum capacitance. Use Equation 12 to estimate the maximum ESR.

$$C_{\text{IN(min)}} = \frac{I_{\text{OUT}} \times V_{\text{OUT}} \times (V_{\text{IN(min)}} - V_{\text{OUT}})}{V_{\text{IN_RIPPLE(CAP)}} \times (V_{\text{IN(min)}})^2 \times f_{\text{SW}}} = \frac{15 \times 1.0 \text{ V} \times (8 \text{ V} - 1.0 \text{ V})}{100 \text{ mV} \times (8 \text{ V})^2 \times 500 \text{ kHz}} = 32.8 \mu\text{F} \quad (11)$$

$$\text{ESR}_{\text{CIN(max)}} = \frac{V_{\text{IN_RIPPLE(ESR)}}}{I_{\text{OUT}} + \left(\frac{I_{\text{P-P}}}{2}\right)} = \frac{50 \text{ mV}}{15 \text{ A} + \left(\frac{4.2 \text{ A}}{2}\right)} = 2.9 \text{ m}\Omega \quad (12)$$

Equation 13 estimates the RMS current in the input capacitors.

$$I_{\text{RMS(cin)}} = I_{\text{OUT}} \times \sqrt{D_{\text{MAX}} \times (1 - D_{\text{MAX}})} = 15 \text{ A} \times \sqrt{\frac{1}{8} \times \left(1 - \frac{1}{8}\right)} = 5.0 \text{ A}_{\text{rms}} \quad (13)$$

Four 1210, 22- μF , 25-V, X5R, ceramic capacitors with approximately 2.5-m Ω ESR and a 2.5-A RMS current rating are selected. Higher voltage capacitors are selected to minimize capacitance loss at the DC bias voltage to ensure the capacitors will have sufficient capacitance at the working voltage while a 1.0- μF capacitor in smaller case size is used to reduce high frequency noise from the MOSFET switching.

Bootstrap Capacitor (C14)

The bootstrap capacitor maintains power to the high-side driver during the high-side switch ON time. Per the requirements of the integrated MOSFET, the value of C_{BOOT} is 100 nF with a minimum 10-V rating.

Bootstrap Resistor (R2)

The bootstrap resistor slows the rising edge of the SW voltage to reduce ringing and improve EMI. Per the datasheet recommendation a 5.1- Ω resistor is selected.

TPS56121

SLUSAH4B – MARCH 2011 – REVISED MARCH 2013

www.ti.com

RC Snubber (R9 and C18)

To effectively limit the switch node ringing, select a 1.0-Ω resistor and a 1000-pF capacitor

VDD Bypass Capacitor (C11)

Per the data sheet recommended pin terminations, bypass VDD to GND with a 1.0-μF capacitor.

BP5 Bypass Capacitor (C12)

Per the data sheet recommended pin functions, bypass BP5 to GND with a capacitor with a value of at least 1.0-μF. For additional filtering and noise immunity, select a 4.7-μF capacitor.

Soft-Start Capacitor (C13)

The soft-start capacitor provides a constant ramp voltage to the error amplifier to provide controlled, smooth start-up. The soft-start capacitor is sized using [Equation 14](#).

$$C_{SS} = \frac{I_{SS}}{V_{FB}} \times t_{SS} = \frac{10 \mu\text{A}}{0.6 \text{V}} \times 2.0 \text{ms} = 33 \text{nF} \quad (14)$$

Current Limit (R1)

The TPS56221 uses the negative drop across the internal low-side FET at the end of the OFF-time to measure the valley of the inductor current. Allowing for a minimum 20-A, or 30% over maximum load, the programming resistor is selected using [Equation 15](#).

$$R_{OCSET} = 95 \times \left(I_{OUT(max)} - \left(\frac{I_{P-P}}{2} \right) \right) + 62.5 \Omega = 95 \times \left(20 \text{ A} - \left(\frac{4.2 \text{ A}}{2} \right) \right) + 62.5 \Omega = 1.76 \text{ k}\Omega \quad (15)$$

Select a standard 1.78-kΩ resistor from the E-48 series.

Feedback Divider (R4, R7)

The TPS56121 converter uses a full operational amplifier with an internally fixed 0.600-V reference. R4 is selected between 10 kΩ and 50 kΩ for a balance of feedback current and noise immunity. With R4 set to 20.5 kΩ, program the output voltage with a resistor divider as calculated in [Equation 16](#).

$$R7 = \frac{V_{FB} \times R4}{(V_{OUT} - V_{FB})} = \frac{0.600 \text{ V} \times 20.5 \text{ k}\Omega}{(1.0 \text{ V} - 0.600 \text{ V})} = 30.8 \text{ k}\Omega \quad (16)$$

Select a standard 30.1-kΩ resistor from the E-48 series.

Compensation (C15, C16, C17, R3, R6)

Using the *TPS40k Loop Stability Tool* for 50 kHz of bandwidth and 60 degrees of phase margin with an R4 value of 20.5 kΩ, the design yields the following values.

- C17 = C_1 = 680 pF
- C15 = C_2 = 2200 pF
- C16 = C_3 = 100 pF
- R6 = R_2 = 1.00 kΩ
- R3 = R_3 = 7.87 kΩ

DESIGN EXAMPLE PERFORMANCE CHARACTERISTICS

Output voltage 12 V to 1.0 V at 0-A to 15-A input current.

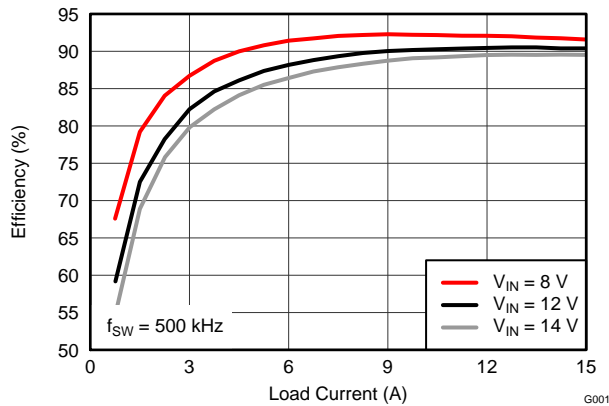

Figure 21. Efficiency vs Load Current

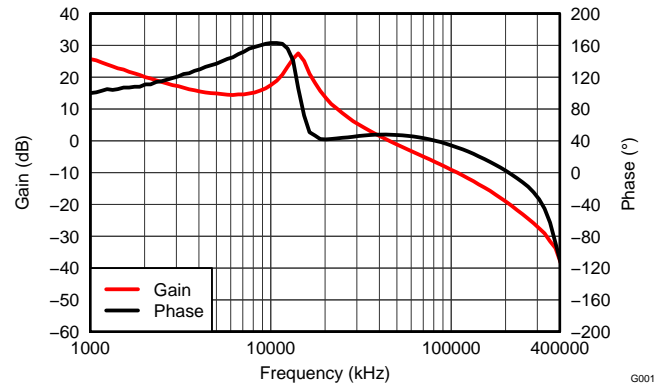

Figure 22. Loop Response, 47-kHz Bandwidth, 48° Phase Margin

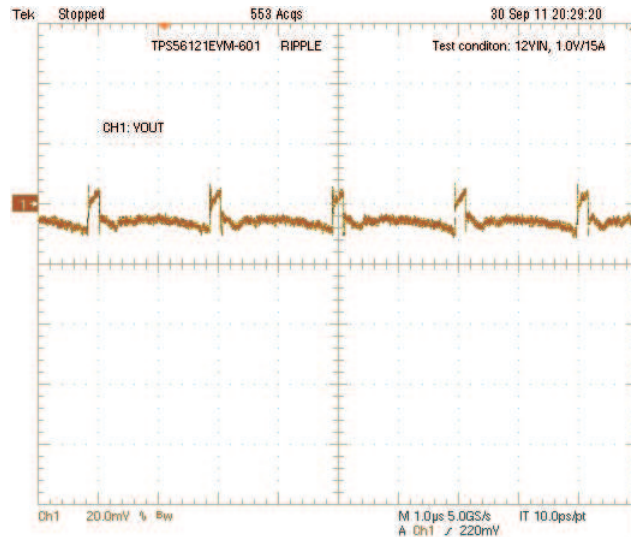

Figure 23. Output Ripple 20 mV/div, 1.0 µs/div, 20 MHz Bandwidth, AC Coupled

Table 3. List of Materials for TPS56121 Design Example

REFERENCE DESIGNATOR	QTY	VALUE	DESCRIPTION	SIZE	PART NUMBER	MANUFACTURER
C1, C2, C3, C4	4	22 μ F	Capacitor, Ceramic, 25 V, X5R, 20%	1210	Std	Std
C5, C11	2	1.0 μ F	Capacitor, Ceramic, 25V, X7R, 20%	0805	Std	Std
C6	0	100 μ F	Capacitor, Aluminum, 16 VDC, \pm 20%	Code D8	EEEEFP1C101AP	Panasonic
C7, C8, C9, C10, C19	5	100 μ F	Capacitor, Ceramic, 6.3V, X5R, 20%	1210	Std	Std
C12	1	4.7 μ F	Capacitor, Ceramic, 10 V, X5R, 20%	0805	Std	Std
C13	1	33 nF	Capacitor, Ceramic, 16 V, X7R, 20%	0603	Std	Std
C14	1	100 nF	Capacitor, Ceramic, 50 V, X7R, 20%	0603	Std	Std
C15	1	2200 pF	Capacitor, Ceramic, 50 V, X7R, 10%	0603	Std	Std
C16	1	100 pF	Capacitor, Ceramic, 50 V, C0G, 5%	0603	Std	Std
C17	1	680 pF	Capacitor, Ceramic, 50 V, C0G, 5%	0603	Std	Std
C18	1	1000 pF	Capacitor, Ceramic, 50 V, X7R, 20%	0603	Std	Std
C20, C21	0	100 μ F	Capacitor, Ceramic, 6.3 V, X5R, 20%	1210	Std	Std
J1, J2	2		Terminal Block, 4-pin, 15 A, 5.1 mm	0.80 x 0.35 inch	ED120/4DS	OST
J3	1		Header, Male 2-pin, 100mil spacing	0.100 inch x 2	PEC02SAAN	Sullins
L1	1	440 nH	Inductor, 440 nH, 30A, 0.32 m Ω	0.530 x 0.510 inch	PA0513.441NLT	Pulse
R1	1	1.78 k Ω	Resistor, Chip, 1/16W, 1%	0603	Std	Std
R2	1	5.10 Ω	Resistor, Chip, 1/16W, 1%	0603	Std	Std
R3	1	7.87 k Ω	Resistor, Chip, 1/16W, 1%	0603	Std	Std
R4	1	20.5 k Ω	Resistor, Chip, 1/16W, 1%	0603	Std	Std
R5	1	49.9 Ω	Resistor, Chip, 1/16W, 1%	0603	Std	Std
R6	1	1.00 k Ω	Resistor, Chip, 1/16W, 1%	0603	Std	Std
R7	1	30.1 k Ω	Resistor, Chip, 1/16W, 1%	0603	Std	Std
R8	1	0 Ω	Resistor, Chip, 1/16 W, 1%	0603	Std	Std
R9	1	1.00 Ω	Resistor, Chip, 1/8 W, 1%	0805	Std	Std
R10	1	100 k Ω	Resistor, Chip, 1/16W, 1%	0603	Std	Std
TP1, TP3, TP11	3		Test Point, Red, Thru Hole	0.125 x 0.125 inch	5010	Keystone
TP2, TP4, TP8, TP9, TP12	5		Test Point, Black, Thru Hole	0.125 x 0.125 inch	5011	Keystone
TP5, TP6	2		Test Point, Yellow, Thru Hole	0.125 x 0.125 inch	5014	Keystone
TP7, TP10	2		Test Point, White, Thru Hole	0.125 x 0.125 inch	5012	Keystone
U1	1		4.5-V to 14-V input, 15-A, synchronous buck converter	QFN-22 6 x 5 mm	TPS56121DQP	TI

Layout Recommendations

- Place input capacitors next to the VIN pin and on the same side as the device. Use wide and short traces or copper planes for the connection from the VIN pin to the input capacitor and from the input capacitor to the power pad of the device.
- Place the BP decoupling capacitor close to the BP pin and on the same side as the device in order to avoid the use of vias. Use wide and short traces for the connection from the BP pin to the capacitor and from the capacitor to the power pad. If vias are not evitable, use at least three vias to reduce the parasitic inductance.
- Include a Kelvin VDD connection, or separate from VIN connection (bypass input capacitors); add a placeholder for a filter resistor between the VDD pin and the input bus. Place the VDD decoupling capacitor near the VDD pin and on the same side as the device to avoid the use of vias. Use wide and short traces for the connection from the VDD pin to the capacitor and from the capacitor to the power pad of the device. If

vias are not avoidable, use at least three vias to reduce the parasitic inductance.

- Maintain the FB trace away from BOOT and SW traces.
- Minimize the area of switch node.
- Use a single ground. Do not use separate signal and power ground.
- Use 3 x 7 thermal vias as suggested in the LAND PATTERN DATA section of this datasheet.

EVM Layout

The TPS56121EVM-601 layout is shown in Figure 24 through Figure 29 for reference.

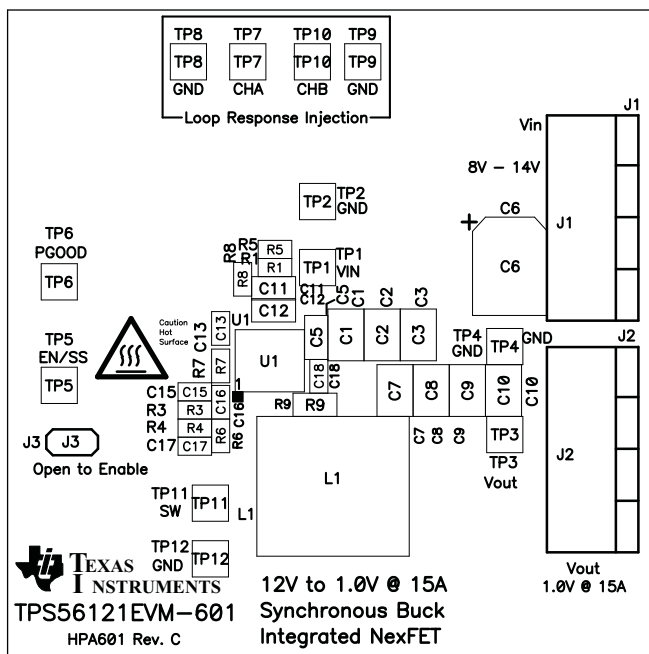

Figure 24. TPS56121EVM-601 Top Assembly Drawing (Top view)

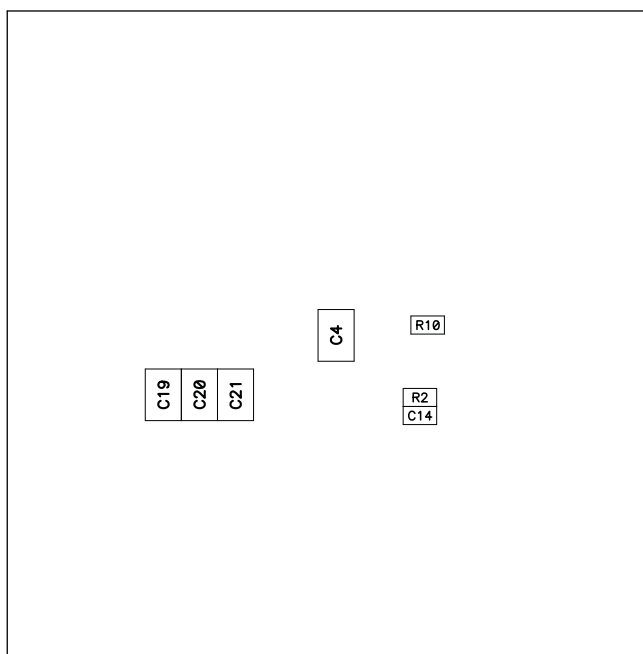

Figure 25. TPS56121EVM-601 Bottom Assembly Drawing (Bottom view)

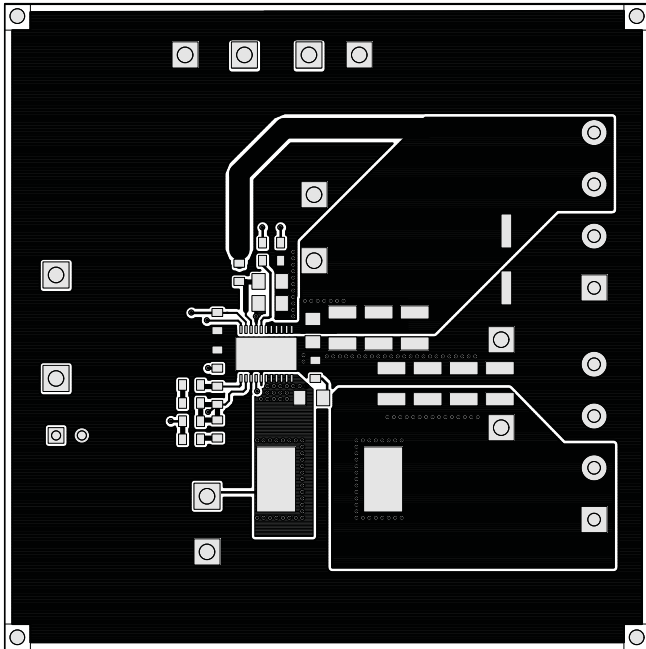

Figure 26. TPS56121EVM-601 Top Copper (Top View)

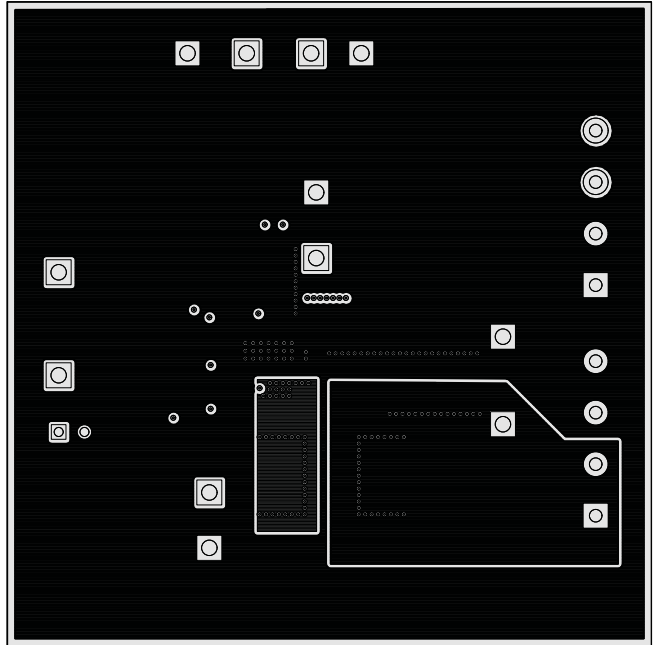

Figure 27. TPS56121EVM-601 Internal 1 (Top View)

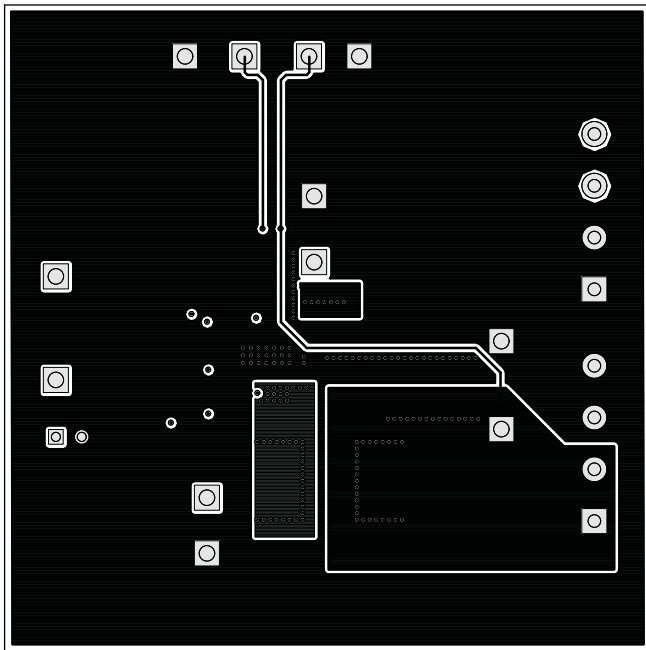

Figure 28. TPS56121EVM-601 Internal 2 (Top View)

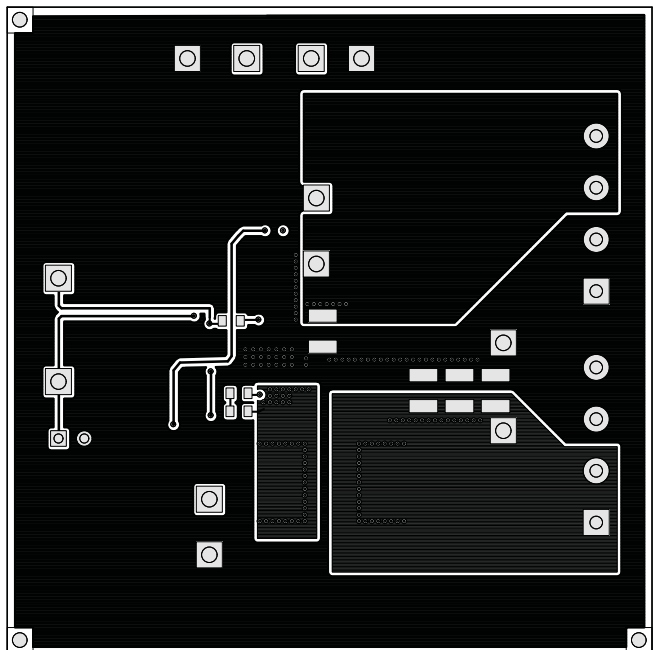

Figure 29. TPS56121EVM-601 Bottom Copper (Top View)

REVISION HISTORY

Changes from Original (March 2011) to Revision A	Page
• Changed characterization conditions	9
• Changed corrected typographical error in Equation 2	12
• Added Switching Node (SW) section	12
• Added clarity to Thermal Shutdown section	13
• Deleted old Design example	14
• Added new Design example	14
• Added Layout Recommendations section	20
• Added EVM Layout section	21

Changes from Revision A (May 2012) to Revision B	Page
• Changed BOOT resistor value from (5 Ω to 10 Ω) to (5 Ω to 15 Ω).	5
• Added Since the TPS56121 is designed for 15-A full-Load current and not intentionally designed for an OCP level below 10 A, use an R_{OCSET} value above 1 k Ω to get an accurate OCP tripping point.	12
• Changed BOOT resistor value from (5 Ω to 10 Ω) to (5 Ω to 15 Ω).	12

PACKAGING INFORMATION

Orderable Device	Status (1)	Package Type	Package Drawing	Pins	Package Qty	Eco Plan (2)	Lead/Ball Finish	MSL Peak Temp (3)	Op Temp (°C)	Top-Side Markings (4)	Samples
TPS56121DQPR	ACTIVE	SON	DQP	22	2500	Pb-Free (RoHS Exempt)	CU SN	Level-2-260C-1 YEAR	-40 to 125	TPS56121	Samples
TPS56121DQPT	ACTIVE	SON	DQP	22	250	Pb-Free (RoHS Exempt)	CU SN	Level-2-260C-1 YEAR	-40 to 125	TPS56121	Samples

(1) The marketing status values are defined as follows:

ACTIVE: Product device recommended for new designs.

LIFEBUY: TI has announced that the device will be discontinued, and a lifetime-buy period is in effect.

NRND: Not recommended for new designs. Device is in production to support existing customers, but TI does not recommend using this part in a new design.

PREVIEW: Device has been announced but is not in production. Samples may or may not be available.

OBSOLETE: TI has discontinued the production of the device.

(2) Eco Plan - The planned eco-friendly classification: Pb-Free (RoHS), Pb-Free (RoHS Exempt), or Green (RoHS & no Sb/Br) - please check <http://www.ti.com/productcontent> for the latest availability information and additional product content details.

TBD: The Pb-Free/Green conversion plan has not been defined.

Pb-Free (RoHS): TI's terms "Lead-Free" or "Pb-Free" mean semiconductor products that are compatible with the current RoHS requirements for all 6 substances, including the requirement that lead not exceed 0.1% by weight in homogeneous materials. Where designed to be soldered at high temperatures, TI Pb-Free products are suitable for use in specified lead-free processes.

Pb-Free (RoHS Exempt): This component has a RoHS exemption for either 1) lead-based flip-chip solder bumps used between the die and package, or 2) lead-based die adhesive used between the die and leadframe. The component is otherwise considered Pb-Free (RoHS compatible) as defined above.

Green (RoHS & no Sb/Br): TI defines "Green" to mean Pb-Free (RoHS compatible), and free of Bromine (Br) and Antimony (Sb) based flame retardants (Br or Sb do not exceed 0.1% by weight in homogeneous material)

(3) MSL, Peak Temp. -- The Moisture Sensitivity Level rating according to the JEDEC industry standard classifications, and peak solder temperature.

(4) Only one of markings shown within the brackets will appear on the physical device.

Important Information and Disclaimer: The information provided on this page represents TI's knowledge and belief as of the date that it is provided. TI bases its knowledge and belief on information provided by third parties, and makes no representation or warranty as to the accuracy of such information. Efforts are underway to better integrate information from third parties. TI has taken and continues to take reasonable steps to provide representative and accurate information but may not have conducted destructive testing or chemical analysis on incoming materials and chemicals. TI and TI suppliers consider certain information to be proprietary, and thus CAS numbers and other limited information may not be available for release.

In no event shall TI's liability arising out of such information exceed the total purchase price of the TI part(s) at issue in this document sold by TI to Customer on an annual basis.

TAPE AND REEL INFORMATION

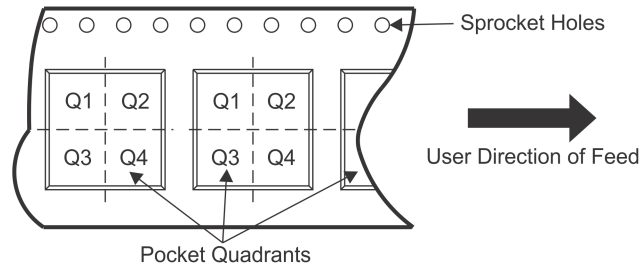
QUADRANT ASSIGNMENTS FOR PIN 1 ORIENTATION IN TAPE

*All dimensions are nominal

Device	Package Type	Package Drawing	Pins	SPQ	Reel Diameter (mm)	Reel Width W1 (mm)	A0 (mm)	B0 (mm)	K0 (mm)	P1 (mm)	W (mm)	Pin1 Quadrant
TPS56121DQPR	SON	DQP	22	2500	330.0	12.4	5.3	6.3	1.8	8.0	12.0	Q1
TPS56121DQPT	SON	DQP	22	250	180.0	12.4	5.3	6.3	1.8	8.0	12.0	Q1

TAPE AND REEL BOX DIMENSIONS

*All dimensions are nominal

Device	Package Type	Package Drawing	Pins	SPQ	Length (mm)	Width (mm)	Height (mm)
TPS56121DQPR	SON	DQP	22	2500	367.0	367.0	35.0
TPS56121DQPT	SON	DQP	22	250	210.0	185.0	35.0

DQP (R-PSON-N22)

PLASTIC SMALL OUTLINE NO-LEAD

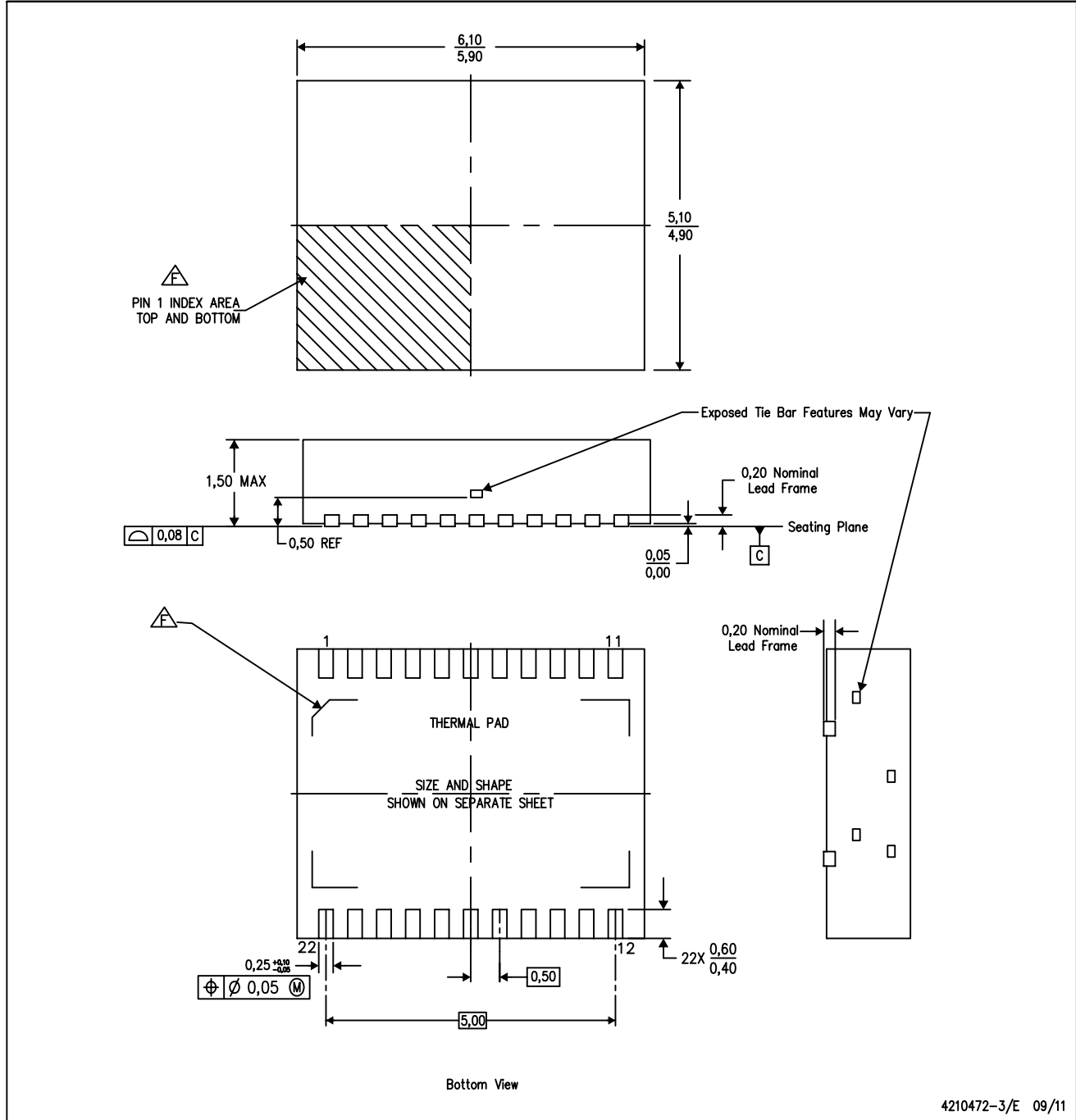

- NOTES:
- A. All linear dimensions are in millimeters. Dimensioning and tolerancing per ASME Y14.5M-1994.
 - B. This drawing is subject to change without notice.
 - C. Small Outline No-Lead (SON) package configuration.
 - D. The package thermal pad must be soldered to the board for thermal and mechanical performance.
 - E. See the additional figure in the Product Data Sheet for details regarding the exposed thermal pad features and dimensions.
 - F. Pin 1 identifiers are located on both top and bottom of the package and within the zone indicated. The Pin 1 identifiers are either a molded, marked, or metal feature.

IMPORTANT NOTICE

Texas Instruments Incorporated and its subsidiaries (TI) reserve the right to make corrections, enhancements, improvements and other changes to its semiconductor products and services per JESD46, latest issue, and to discontinue any product or service per JESD48, latest issue. Buyers should obtain the latest relevant information before placing orders and should verify that such information is current and complete. All semiconductor products (also referred to herein as "components") are sold subject to TI's terms and conditions of sale supplied at the time of order acknowledgment.

TI warrants performance of its components to the specifications applicable at the time of sale, in accordance with the warranty in TI's terms and conditions of sale of semiconductor products. Testing and other quality control techniques are used to the extent TI deems necessary to support this warranty. Except where mandated by applicable law, testing of all parameters of each component is not necessarily performed.

TI assumes no liability for applications assistance or the design of Buyers' products. Buyers are responsible for their products and applications using TI components. To minimize the risks associated with Buyers' products and applications, Buyers should provide adequate design and operating safeguards.

TI does not warrant or represent that any license, either express or implied, is granted under any patent right, copyright, mask work right, or other intellectual property right relating to any combination, machine, or process in which TI components or services are used. Information published by TI regarding third-party products or services does not constitute a license to use such products or services or a warranty or endorsement thereof. Use of such information may require a license from a third party under the patents or other intellectual property of the third party, or a license from TI under the patents or other intellectual property of TI.

Reproduction of significant portions of TI information in TI data books or data sheets is permissible only if reproduction is without alteration and is accompanied by all associated warranties, conditions, limitations, and notices. TI is not responsible or liable for such altered documentation. Information of third parties may be subject to additional restrictions.

Resale of TI components or services with statements different from or beyond the parameters stated by TI for that component or service voids all express and any implied warranties for the associated TI component or service and is an unfair and deceptive business practice. TI is not responsible or liable for any such statements.

Buyer acknowledges and agrees that it is solely responsible for compliance with all legal, regulatory and safety-related requirements concerning its products, and any use of TI components in its applications, notwithstanding any applications-related information or support that may be provided by TI. Buyer represents and agrees that it has all the necessary expertise to create and implement safeguards which anticipate dangerous consequences of failures, monitor failures and their consequences, lessen the likelihood of failures that might cause harm and take appropriate remedial actions. Buyer will fully indemnify TI and its representatives against any damages arising out of the use of any TI components in safety-critical applications.

In some cases, TI components may be promoted specifically to facilitate safety-related applications. With such components, TI's goal is to help enable customers to design and create their own end-product solutions that meet applicable functional safety standards and requirements. Nonetheless, such components are subject to these terms.

No TI components are authorized for use in FDA Class III (or similar life-critical medical equipment) unless authorized officers of the parties have executed a special agreement specifically governing such use.

Only those TI components which TI has specifically designated as military grade or "enhanced plastic" are designed and intended for use in military/aerospace applications or environments. Buyer acknowledges and agrees that any military or aerospace use of TI components which have **not** been so designated is solely at the Buyer's risk, and that Buyer is solely responsible for compliance with all legal and regulatory requirements in connection with such use.

TI has specifically designated certain components as meeting ISO/TS16949 requirements, mainly for automotive use. In any case of use of non-designated products, TI will not be responsible for any failure to meet ISO/TS16949.

Products

Audio	www.ti.com/audio
Amplifiers	amplifier.ti.com
Data Converters	dataconverter.ti.com
DLP® Products	www.dlp.com
DSP	dsp.ti.com
Clocks and Timers	www.ti.com/clocks
Interface	interface.ti.com
Logic	logic.ti.com
Power Mgmt	power.ti.com
Microcontrollers	microcontroller.ti.com
RFID	www.ti-rfid.com
OMAP Applications Processors	www.ti.com/omap
Wireless Connectivity	www.ti.com/wirelessconnectivity

Applications

Automotive and Transportation	www.ti.com/automotive
Communications and Telecom	www.ti.com/communications
Computers and Peripherals	www.ti.com/computers
Consumer Electronics	www.ti.com/consumer-apps
Energy and Lighting	www.ti.com/energy
Industrial	www.ti.com/industrial
Medical	www.ti.com/medical
Security	www.ti.com/security
Space, Avionics and Defense	www.ti.com/space-avionics-defense
Video and Imaging	www.ti.com/video

TI E2E Community

e2e.ti.com