

High-Efficiency, 5-A Step-Down Regulator with Integrated Switcher

Check for Samples: [TPS53316](#)

FEATURES

- 96% Maximum Efficiency
- Continuous 5-A Output Current Capability
- Support all MLCC Output Capacitor
- SmoothPWM™ Auto-Skip Eco-mode™ for Light-Load Efficiency
- Voltage Mode Control
- Single Rail Input
- Selectable Frequency
- Selectable OCP Threshold
- Selectable Soft-Start Time
- 2.9 V to 6.0 V Input Voltage Range
- Adjustable Output Voltage Ranging from 0.6 V up to $0.8 \times V_{IN}$
- Soft-Stop Output Discharge During Disable
- Overcurrent, Overvoltage and Over-Temperature Protection
- Open-Drain Power Good Indication
- Internal Bootstrap Switch
- Supports Pre-Bias Start-Up Functionality
- Small 3×3 , 16-Pin, QFN Package
- Low $R_{DS(on)}$, 22-m Ω with 3.3-V input and 18-m Ω with 5-V Input

LOW VOLTAGE APPLICATIONS

- Low-Voltage Applications for 5-V Step-Down Rail
- Low-Voltage Applications for 3.3-V Step-Down Rail

DESCRIPTION

TPS53316 provides a fully integrated 3.3-V or 5-V input, synchronous buck converter with 16 total components, in 200 mm² of PCB area. Due to low $R_{DS(on)}$ and TI proprietary SmoothPWM™ skip mode of operation, it enables 96% peak efficiency and over 90% efficiency at load as light as 100 mA. It requires only two 22- μ F ceramic output capacitors for a power-dense, 5-A solution.

TPS53316 features 750-kHz, 1.1-MHz and 2-MHz switching frequency selections, pre-bias startup, selectable internal softstart, output soft discharge, internal VBST switch, power good, EN/Input UVLO, overcurrent, overvoltage, undervoltage and over temperature protections and all ceramic output capacitor support. It supports input voltages from 2.9 V to 6.0 V and no extra bias voltage is needed. The output voltage is adjustable from 0.6 V up to $0.8 \times V_{IN}$.

TPS53316 is available in the 3 mm \times 3 mm, 16-pin, QFN package (Green RoHS compliant and Pb free) and is specified from -40°C to 85°C .

TYPICAL APPLICATION CIRCUIT

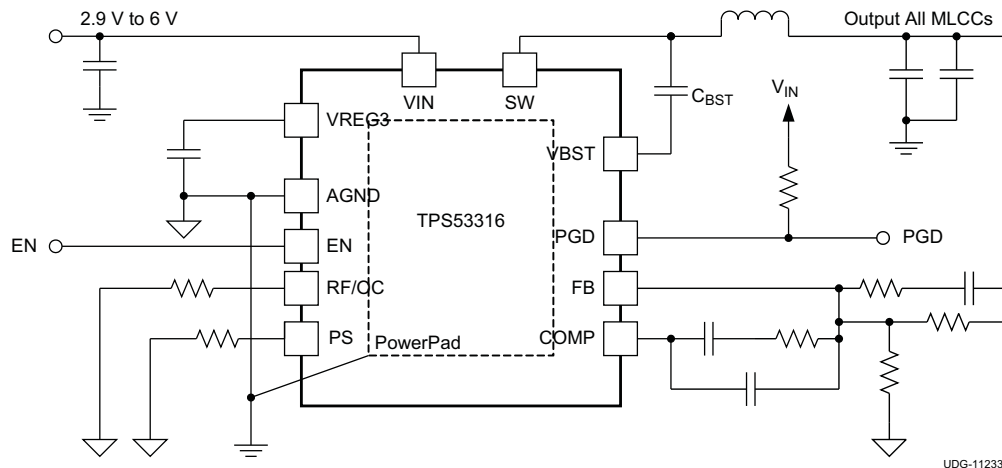

Please be aware that an important notice concerning availability, standard warranty, and use in critical applications of Texas Instruments semiconductor products and disclaimers thereto appears at the end of this data sheet.

Eco-mode, SmoothPWM are trademarks of Texas Instruments.

TPS53316

SLUSAP5 – DECEMBER 2011

www.ti.com

This integrated circuit can be damaged by ESD. Texas Instruments recommends that all integrated circuits be handled with appropriate precautions. Failure to observe proper handling and installation procedures can cause damage.

ESD damage can range from subtle performance degradation to complete device failure. Precision integrated circuits may be more susceptible to damage because very small parametric changes could cause the device not to meet its published specifications.

ORDERING INFORMATION⁽¹⁾⁽²⁾

T _A	PACKAGE	ORDERABLE DEVICE NUMBER	PINS	OUTPUT SUPPLY	MINIMUM QUANTITY	ECO PLAN
Plastic QFN (RGT)	-40°C to 85°C	TPS53316RGTR	16	Tape and reel	3000	Green (RoHS and no Pb/Br)
		TPS53316RGTT	16	Mini reel	250	

- (1) For the most current package and ordering information, see the *Package Option Addendum* at the end of this document, or visit the TI website at www.ti.com.
- (2) Package drawings, standard packing quantities, thermal data, symbolization, and PCB design guidelines are available at www.ti.com/sc/package

ABSOLUTE MAXIMUM RATINGS⁽¹⁾

Over operating free air-temperature range (unless otherwise noted)

		VALUE	UNIT	
Input voltage range	VIN	-0.3 to 7	V	
	VBST	-0.3 to 17		
	VBST(with respect to LL)	-0.3 to 7		
	EN	-0.3 to 7		
	FB, PS, RF/OC	-0.3 to 3.7		
Output voltage range	SW	DC	-1 to 7	V
		Pulse < 20ns, E=5μJ	≥ -5 or <10	
	PGD	-0.3 to 7		
	COMP, VREG3	-0.3 to 3.7		
	PGND	-0.3 to 0.3		
Operating free-air temperature, T _A		-40 to 85	°C	
Storage temperature range, T _{stg}		-55 to 150	°C	
Junction temperature range, T _J		-40 to 150	°C	
Lead temperature 1,6 mm (1/16 inch) from case for 10 seconds		300	C	

- (1) Stresses beyond those listed under "absolute maximum ratings" may cause permanent damage to the device. These are stress ratings only and functional operation of the device at these or any other conditions beyond those indicated under "recommended operating conditions" is not implied. Exposure to absolute-maximum-rated conditions for extended periods may affect device reliability.

RECOMMENDED OPERATING CONDITIONS

		VALUE		UNIT
		MIN	MAX	
Input voltage range	VIN (main supply)	2.9	6	V
	VBST	-0.1	13.5	
	VBST(with respect to SW)	-0.1	6	
	EN,	-0.1	6	
	FB, PS, RF/OC	-0.1	3.5	
Output voltage range	SW	-1	6.5	V
	PGD	-0.1	6	
	COMP, VREG3	-0.1	3.5	
	PGND	-0.1	0.1	
Junction temperature range, T _J		-40	125	°C

THERMAL INFORMATION

THERMAL METRIC ⁽¹⁾		TPS53316	UNITS
		RGT (16) PINS	
θ_{JA}	Junction-to-ambient thermal resistance	45.9	°C/W
θ_{JCTop}	Junction-to-case (top) thermal resistance	54.3	
θ_{JB}	Junction-to-board thermal resistance	18.3	
ψ_{JT}	Junction-to-top characterization parameter	1.1	
ψ_{JB}	Junction-to-board characterization parameter	18.3	
θ_{JCbott}	Junction-to-case (bottom) thermal resistance	5.3	

(1) For more information about traditional and new thermal metrics, see the *IC Package Thermal Metrics* application report, [SPRA953](#).

ELECTRICAL CHARACTERISTICS

 over operating free-air temperature range, $V_{IN} = 3.3V$, $PGND = GND$ (unless otherwise noted)

PARAMETER		CONDITIONS	MIN	TYP	MAX	UNIT
SUPPLY: VOLTAGE, CURRENTS, AND UVLO						
V_{VIN}	VIN supply voltage	Nominal input voltage range	2.9		6.0	V
$I_{VIN(sdn)}$	VIN shutdown current	EN = LO			15	μA
I_{VIN}	VIN supply current	EN = HI, $V_{FB} = 0.63 V$, No load		2.0	3.5	mA
V_{UVLO}	VIN UVLO threshold	Ramp up; EN = HI		2.8		V
$V_{UVLO(hys)}$	VIN UVLO hysteresis	VIN UVLO hysteresis		120		mV
V_{REG3}	LDO output	$V_{VIN} = 5 V$, $0 \leq I_{DD} \leq 5 mA$	3.135	3.3	3.465	V
VOLTAGE FEEDBACK LOOP: VREF AND ERROR AMPLIFIER						
V_{VREF}	VREF	Internal precision reference voltage		0.6		V
TOL_{VREF}	VREF tolerance	$0^\circ C \leq T_A \leq 85^\circ C$	-1%		1%	
		$-40^\circ C \leq T_A \leq 85^\circ C$	-1.25%		1.25%	
$UGBW^{(1)}$	Unity gain bandwidth		14			MHz
$A_{OL}^{(1)}$	Open loop gain		80			dB
I_{FBINT}	FB input leakage current	Sourced from FB pin			30	nA
$I_{EA(max)}^{(1)}$	Output sinking and sourcing current	$C_{COMP} = 20 pF$		5		mA
$SR^{(1)}$	Slew rate			5		V/ μs
OCP: OVERCURRENT AND ZERO CROSSING						
$I_{OCP13A}^{(2)}$	Overcurrent limit on high-side FET	4.5-A setting, when I_{OUT} exceeds this threshold for 4 consecutive cycles, $V_{VIN} = 3.3V$, $V_{OUT} = 1.5 V$ with 1- μH inductor, $f_{SW} = 1.1 MHz$, $T_A = 25^\circ C$	4.05	4.5	4.95	A
$I_{OCPH3A}^{(2)}$	One-time overcurrent latch off on the low-side FET	4.5-A setting, immediate shut down when sensed current reach this value $V_{VIN} = 3.3 V$, $V_{OUT} = 0.6 V$ with 1- μH inductor, $f_{SW} = 1.1 MHz$, $T_A = 25^\circ C$	4.49	5.1	5.61	A
$I_{OCP15A}^{(2)}$	Overcurrent limit on high-side FET	6.5-A setting, when I_{OUT} exceeds this threshold for 4 consecutive cycles, $V_{VIN} = 3.3 V$, $V_{OUT} = 1.5 V$ with 1- μH inductor, $f_{SW} = 1.1 MHz$, $T_A = 25^\circ C$	6.1	6.8	7.5	A
$I_{OCPH5A}^{(2)}$	One time overcurrent latch off on the low-side FET	6.5-A setting, immediate shut down when sensed current reach this value $V_{VIN} = 3.3 V$, $V_{OUT} = 0.6 V$ with 1- μH inductor, $f_{SW} = 1.1 MHz$, $T_A = 25^\circ C$	6.75	7.50	8.30	A
t_{hiccup}	Hiccup time interval	$f_{SW} = 1.1 MHz$		14.5		ms
$V_{ZXOFF}^{(1)}$	Zero crossing comparator internal offset	PGND – SW, SKIP mode	-4.5	-3.0	-1.5	mV
PROTECTION: OVP, UVP, PGD, AND INTERNAL THERMAL SHUTDOWN						
V_{OVP}	Overvoltage protection threshold voltage	Measured at the FB w/r/t VREF	114%	117%	120%	
V_{UVP}	Undervoltage protection Threshold voltage	Measured at the FB w/r/t VREF	80%	83%	86%	
V_{PGDL}	PGD low threshold	Measured at the FB w/r/t VREF	80%	83%	86%	
V_{PGDU}	PGD upper threshold	Measured at the FB w/r/t VREF	114%	117%	120%	
$V_{INMINPG}$	Minimum input voltage for valid PGD at start-up	Measured at VIN with 1-mA sink current on PGD pin at start up		1		V
$THSD^{(1)}$	Thermal shutdown		130	140	150	$^\circ C$
$THSD_{HYS}^{(1)}$	Thermal shutdown hysteresis	Controller start again after temperature has dropped		40		$^\circ C$

(1) Ensured by design. Not production tested.

(2) See Figure 5 and Figure 6 on OCP level for other operating conditions.

ELECTRICAL CHARACTERISTICS (continued)

over operating free-air temperature range, VIN = 3.3V, PGND = GND (unless otherwise noted)

PARAMETER		CONDITIONS	MIN	TYP	MAX	UNIT
LOGIC PINS: I/O VOLTAGE AND CURRENT						
V _{PGPD}	PGD pull down voltage	Pull down voltage with 4mA sink current		0.1	0.3	V
I _{PGLK}	PGD leakage current	Hi-Z leakage current, Apply 3.3V in off state	-2	0	2	μA
R _{ENPU}	Enable pull-up resistor			2.25		MΩ
V _{ENH}	EN logic high	V _{VIN} = 3.3 V	0.82	0.97	1.10	V
		V _{VIN} = 5 V	0.95	1.10	1.25	V
V _{ENHYS}	EN hysteresis	V _{VIN} = 3.3 V		0.16	0.24	V
		V _{VIN} = 5 V		0.2	0.275	V
P _S THS	PS mode threshold voltage	Level 1 to Level 2 ⁽³⁾		0.12		V
		Level 2 to Level 3		0.4		
		Level 3 to Level 4		0.8		
		Level 4 to Level 5		1.4		
		Level 5 to Level 6		2.2		
I _{PS}	PS source	10-μA pull-up current when enabled	8	10	12	μA
R _{F/OC} THS	RF/OC pin threshold voltage	Level 1 to Level 2 ⁽⁴⁾		0.12		V
		Level 2 to Level 3		0.4		
		Level 3 to Level 4		0.8		
		Level 4 to Level 5		1.4		
		Level 5 to Level 6		2.2		
I _{RF/OC}	RF/OC source current	10-μA pull-up current when enabled	8	10	12	μA
BOOT STRAP: VOLTAGE AND LEAKAGE CURRENT						
I _{VBSTLK}	VBST leakage current	V _{VIN} = 3.3 V, V _{VBST} = 6.6 V, T _A = 25°C			1	μA
TIMERS: SS, FREQUENCY, RAMP, ON-TIME AND I/O TIMING						
t _{SS_1}	Delay after EN Asserting	EN = 'HI'		0.2		ms
t _{SS_2}	Soft start ramp_up time	0 V ≤ V _{SS} ≤ 0.6 V		0.4		ms
		0 V ≤ V _{SS} ≤ 0.6 V, 4 x SS time(option2)		1.6		
t _{PGDENDLY}	PGD startup delay time	V _{SS} = 0.6 V to PGD (SSOK) going high		0.3		ms
		V _{SS} = 0.6 V to PGD (SSOK), option 2		1.2		
t _{OVPDLY}	OVP delay time	Time from FB out of +20% of VREF to OVP fault	1.0	1.7	2.5	μs
t _{UVPDLY}	UVP delay time	Time from FB out of -20% of VREF to UVP fault		10		μs
f _{SW}	Switching frequency	All modes, f _{SET} = 0.75 MHz	0.653	0.725	0.798	MHz
		All modes, f _{SET} = 1.1 MHz	0.99	1.10	1.21	
		FCCM and DE mode, f _{SET} = 2 MHz	1.71	1.90	2.09	
		HEF mode, f _{SET} = 2 MHz	1.566	1.800	2.034	
	Ramp amplitude ⁽⁵⁾	2.9 V ≤ V _{VIN} ≤ 6.0 V		V _{VIN} /4		V
t _{MIN(off)}	Minimum OFF time, FCCM and DE	All frequencies		90	130	ns
	Minimum OFF time, HEF	f _{SW} = 1.1 MHz		160	240	ns
D _{MAX}	Maximum duty cycle, FCCM and DE	f _{SW} = 1.1 MHz	84%	89%		
D _{MAX}	Maximum duty cycle, HEF	All frequencies	75%	81%		
R _{SFTSTP}	Soft-discharge transistor resistance	EN = LO, V _{VIN} = 3.3 V, V _{OUT} = 0.5 V		60		Ω

(3) See PS pin description for levels.

(4) See RF/OC pin description for levels.

(5) Ensured by design. Not production tested.

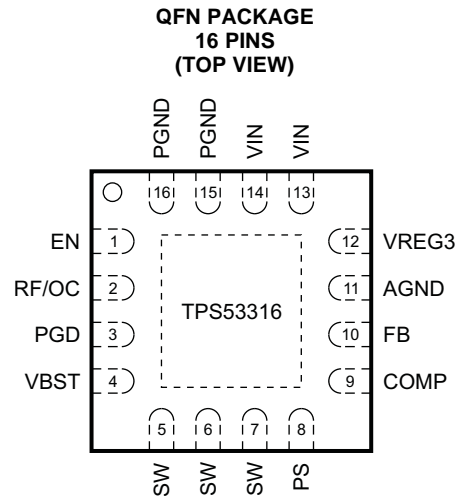
DEVICE INFORMATION

PIN DESCRIPTIONS

PIN		I/O ⁽¹⁾	DESCRIPTION
NAME	NO.		
AGND	11	G	Device analog ground terminal
COMP	9	O	Error amplifier compensation terminal. Type III compensation method is generally recommended for stability.
EN	1	I	Enable pin. Internally pulled-up to the VIN pin through a 2-M Ω resistor. The EN voltage needs to be less than ($V_{IN} + 0.5$ V)
FB	10	I	Voltage feedback pin. Use for OVP, UVP and PGD determination
PGD	3	O	Power good output flag. Open drain output. Pull up to an external rail via a resistor
PGND	15 16	P	Device power ground terminal
PS	8	I	Mode configuration pin (with 10 μ A current): Connecting to ground: Forced CCM with 4 x soft-start time Pulled high or floating (internal pulled high): Forced CCM master Connect with 24.3 k Ω to GND: HEF mode with 4 x soft-start time, Connect with 57.6 k Ω to GND: HEFF mode Connect with 105 k Ω to GND : DE mode Connect with 174 k Ω to GND: DE Mode with 4 x soft-start time
RF/OC	2	I	Switching frequency and OC level configuration pin: Connecting to ground: 1.1 MHz, 6.5 A OCP Pulled high or floating (internal pulled high): 1.1 MHz, 4.5 A OCP Connect with 24.3 k Ω to GND: 750 kHz, 4.5 A OCP Connect with 57.6 k Ω to GND: 750 kHz, 6.5 A OCP Connect with 105 k Ω to GND : 2 MHz, 4.5 A OCP Connect with 174 k Ω to GND: 2MHz, 6. 5A OCP
SW	5 6 7	B	Output inductor connection to integrated power devices
VBST	4	P	Supply input for high-side MOSFET (bootstrap terminal). Connect capacitor from this pin to SW terminal
VREG3	12	O	3.3V LDO output, serves as supply voltage for internal analog circuitry. The EN pin controls the turn-on function of the LDO.
VIN	13 14	P	Gate driver supply and power conversion input voltage. The input range is from 2.9 V to 6 V.
PowerPad	–	–	Thermal pad of the device. use 4 or 5 vias to connect to GND plane for heat dissipation.

(1) I – Input; B – Bidirectional; O – Output; G – Ground; P – Supply (or Ground)

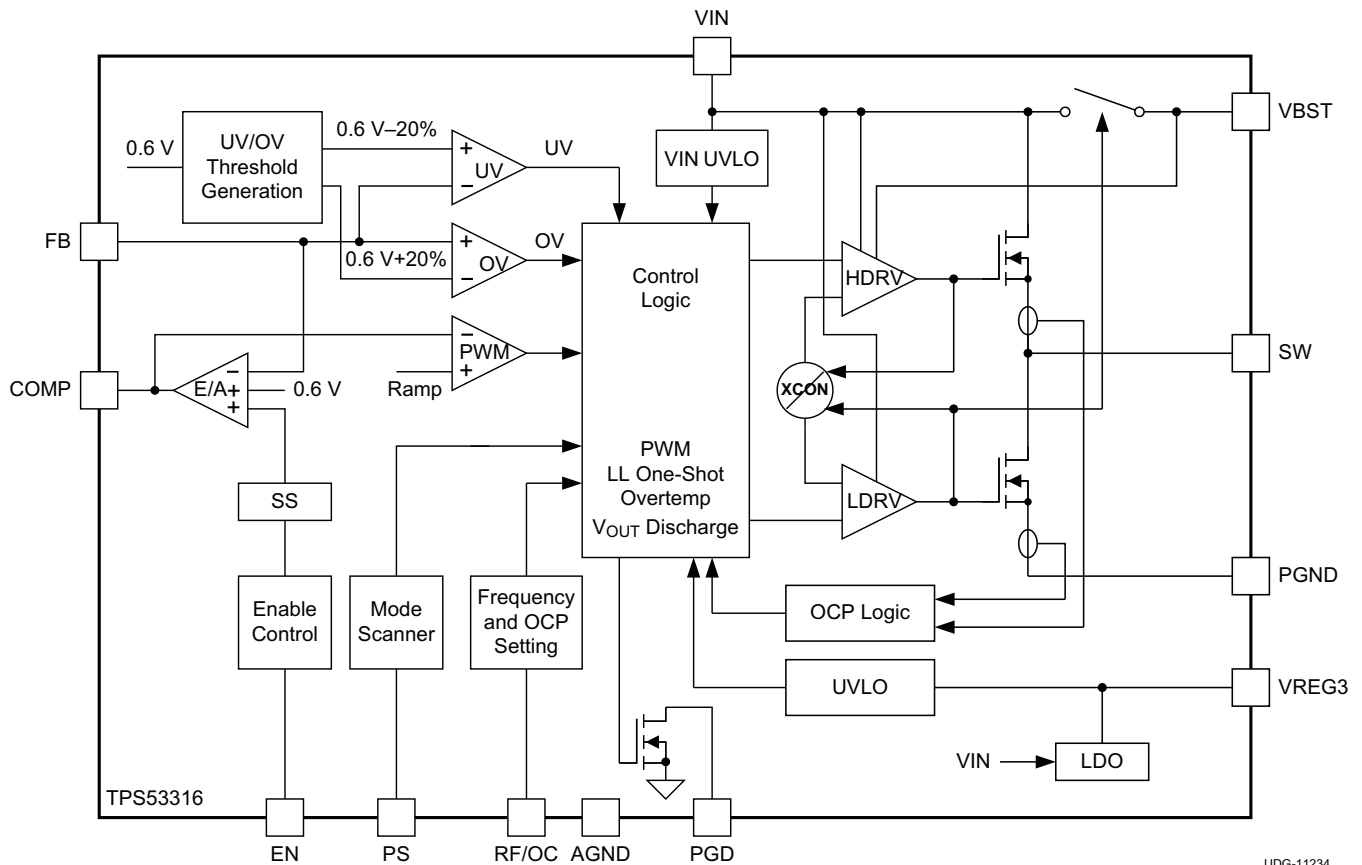
FUNCTIONAL BLOCK DIAGRAM



UDG-11234

TYPICAL CHARACTERISTICS

Inductor used: PCMC065T-1R0, 1 μ H, 5.6 m Ω

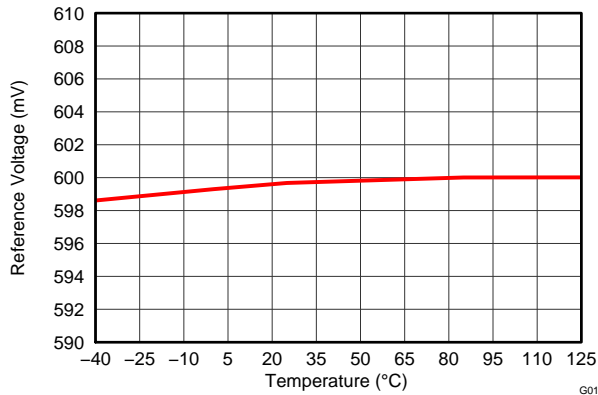

Figure 1. Reference Voltage vs. Temperature

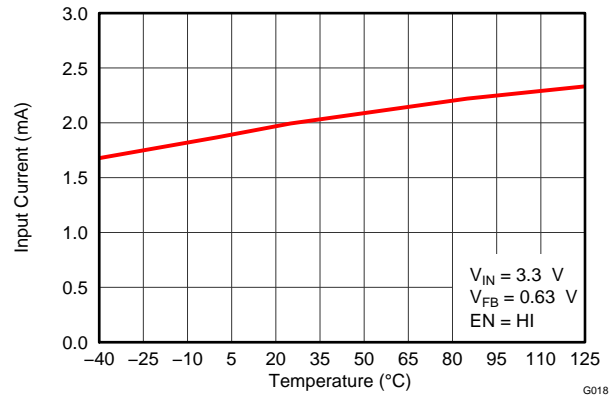

Figure 2. Input Current vs. Temperature

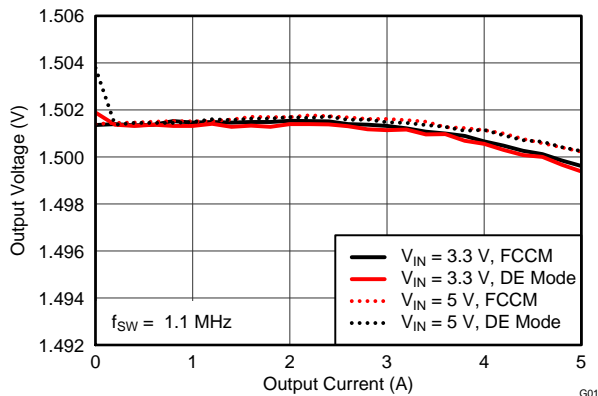

Figure 3. Output Voltage vs. Output Current

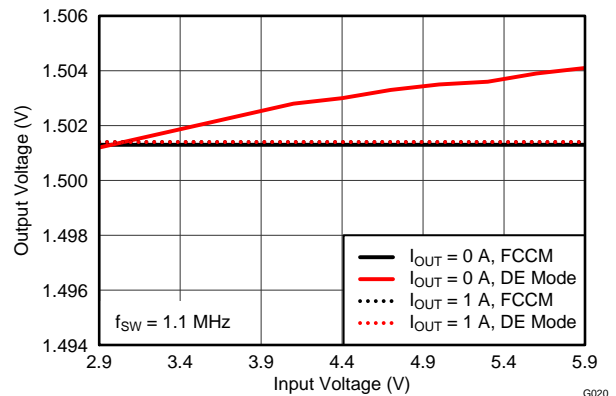

Figure 4. Output Voltage vs. Input Voltage

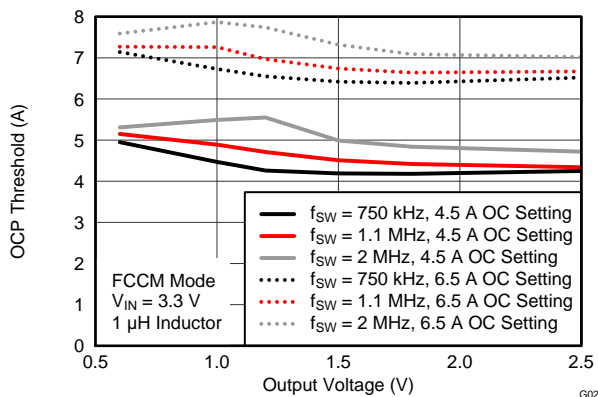

Figure 5. OCP Threshold vs. Output Voltage

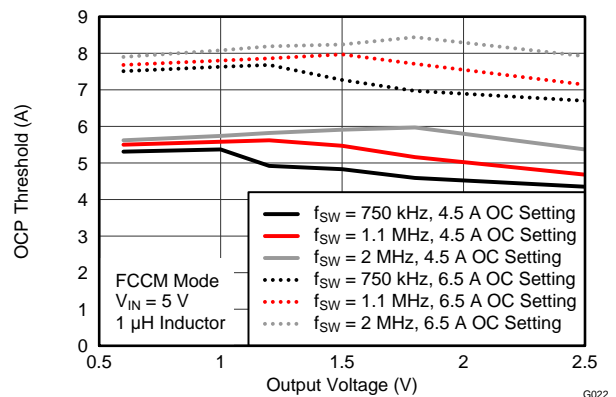

Figure 6. OCP Threshold vs. Output Voltage

TYPICAL CHARACTERISTICS (continued)

Inductor used: PCMC065T-1R0, 1 μ H, 5.6 m Ω

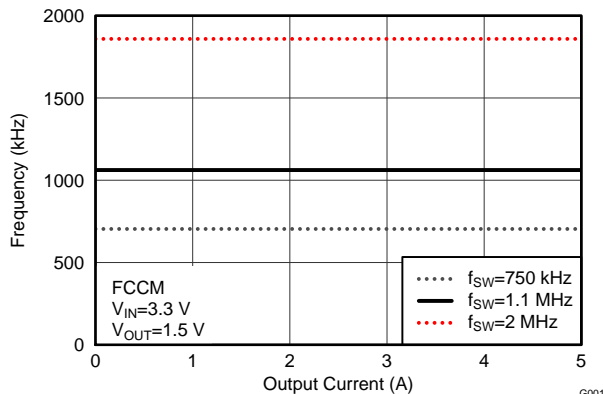

Figure 7. Frequency vs. Output Current, FCCM

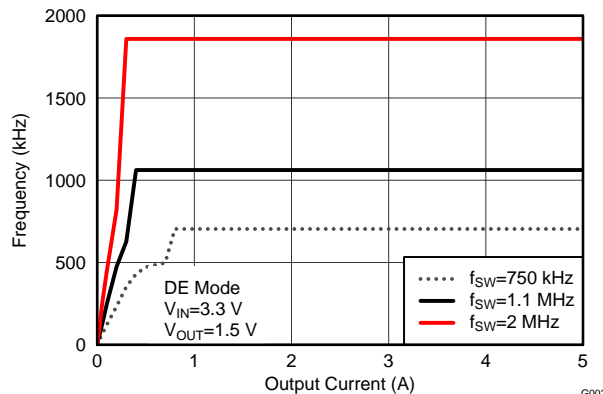

Figure 8. Frequency vs. Output Current, DE Mode

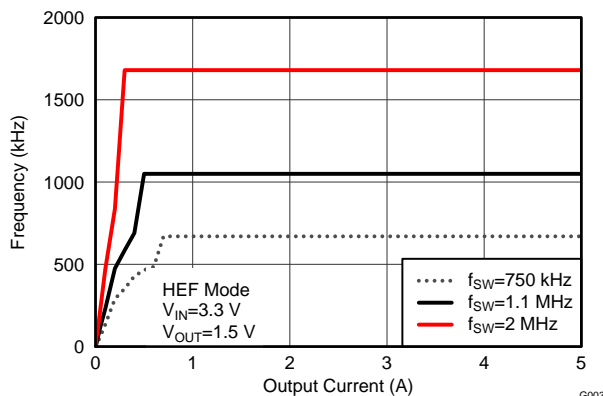

Figure 9. Frequency vs. Output Current, HEF Mode

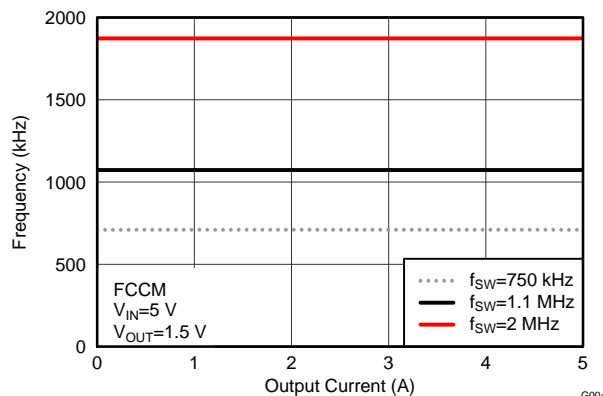

Figure 10. Frequency vs. Output Current, FCCM

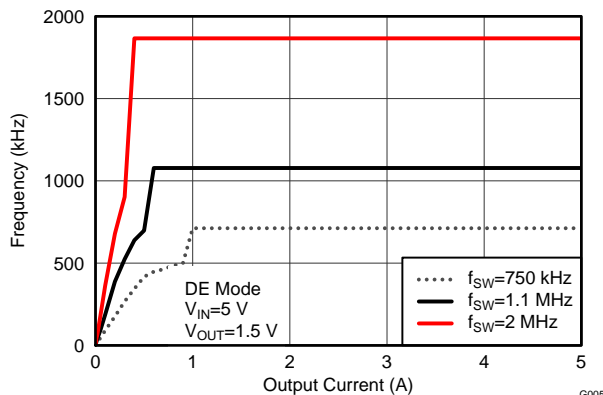

Figure 11. Frequency vs. Output Current, DE Mode

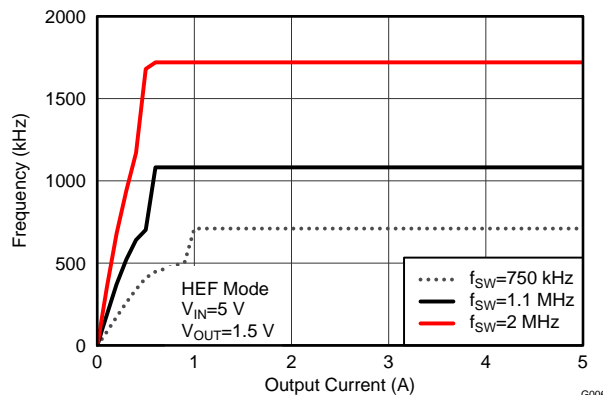

Figure 12. Frequency vs. Output Current, HEF Mode

TYPICAL CHARACTERISTICS (continued)

Inductor used: PCMC065T-1R0, 1 μ H, 5.6 m Ω

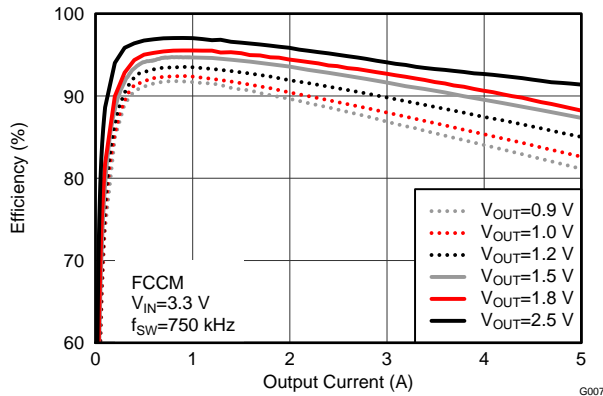

Figure 13. Efficiency vs. Output Current, FCCM

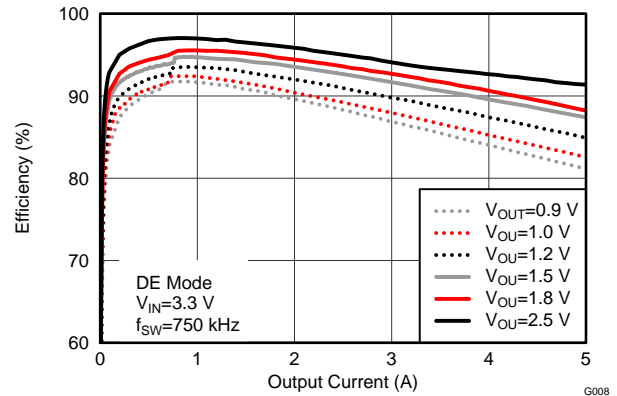

Figure 14. Efficiency vs. Output Current, DE Mode

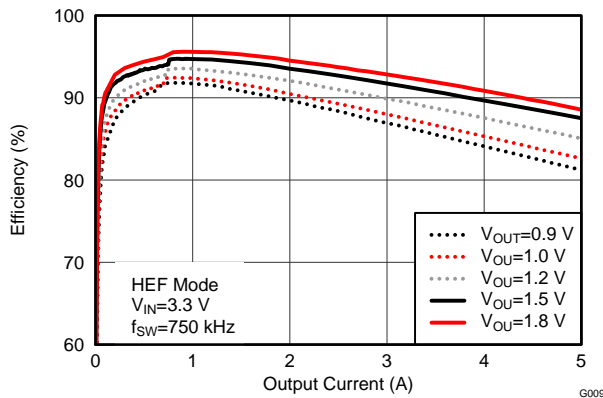

Figure 15. Efficiency vs. Output Current, HEF Mode

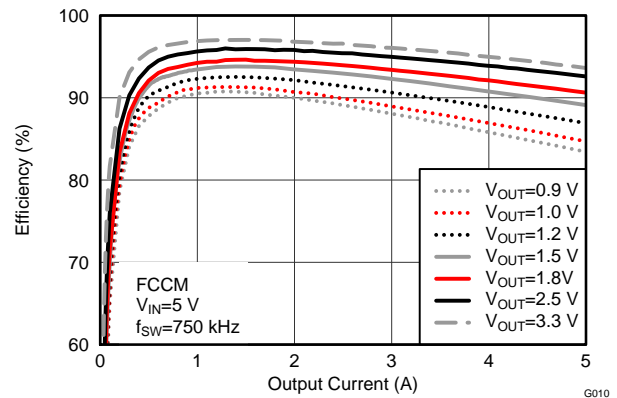

Figure 16. Efficiency vs. Output Current, FCCM

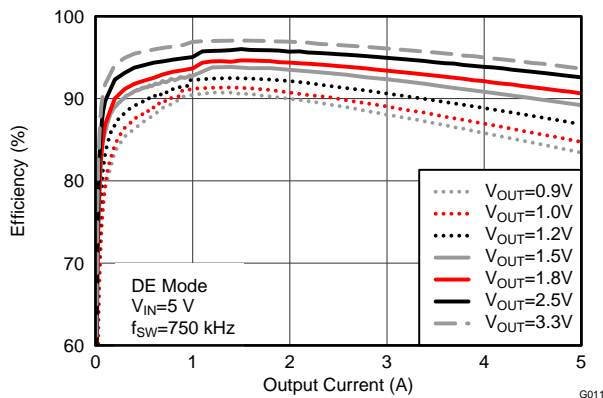

Figure 17. Efficiency vs. Output Current, DE Mode

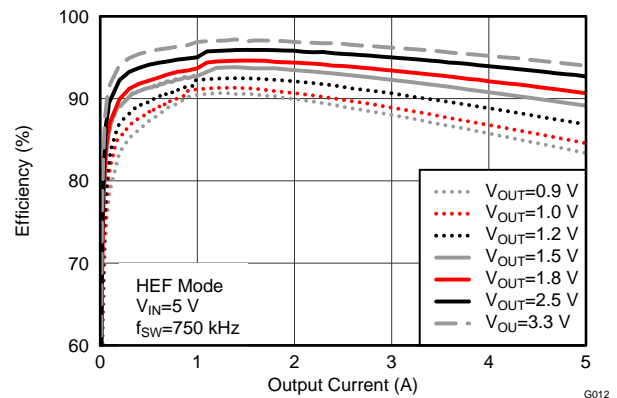

Figure 18. Efficiency vs. Output Current, HEF Mode

TYPICAL CHARACTERISTICS (continued)

Inductor used: PCMC065T-1R0, 1 μ H, 5.6 m Ω

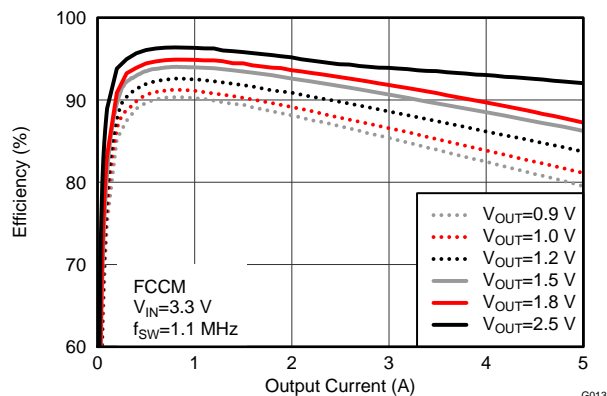

Figure 19. Efficiency vs. Output Current, FCCM

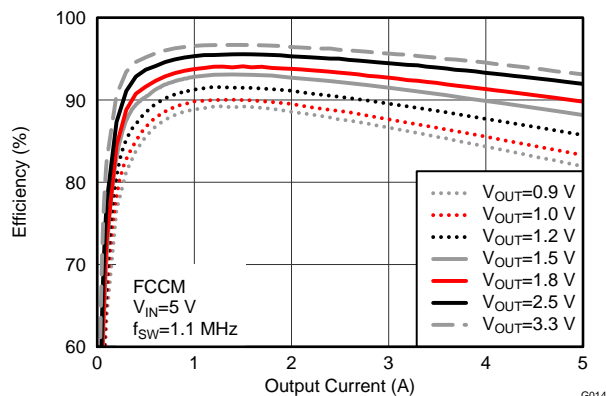

Figure 20. Efficiency vs. Output Current, FCCM

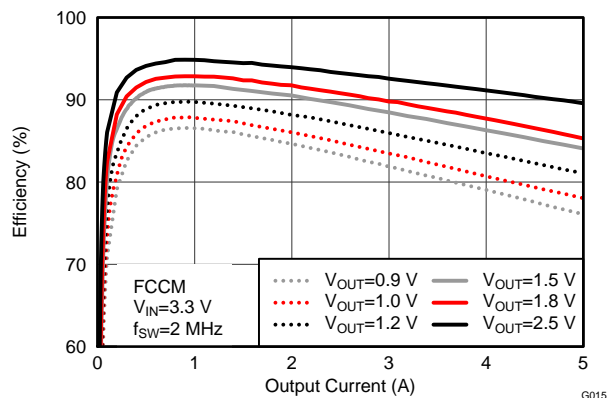

Figure 21. Efficiency vs. Output Current, FCCM

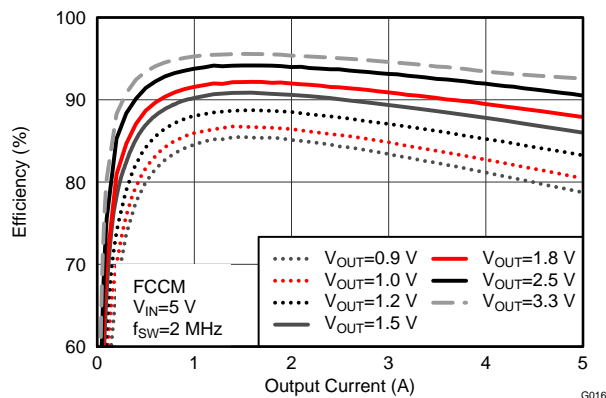

Figure 22. Efficiency vs. Output Current, FCCM

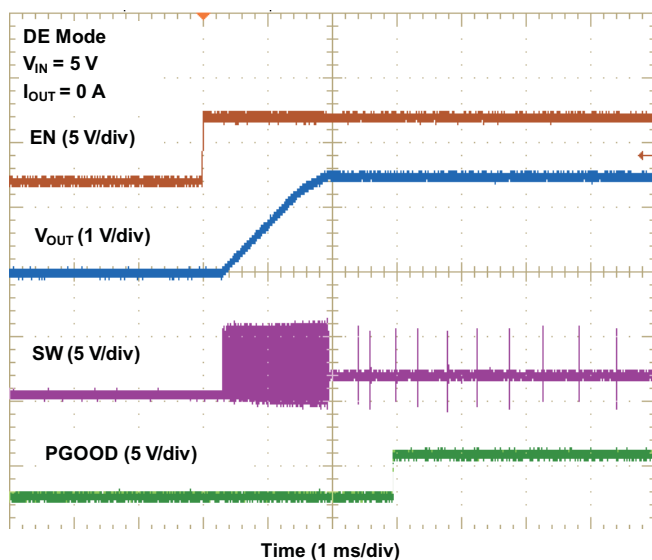

Figure 23. Normal Startup

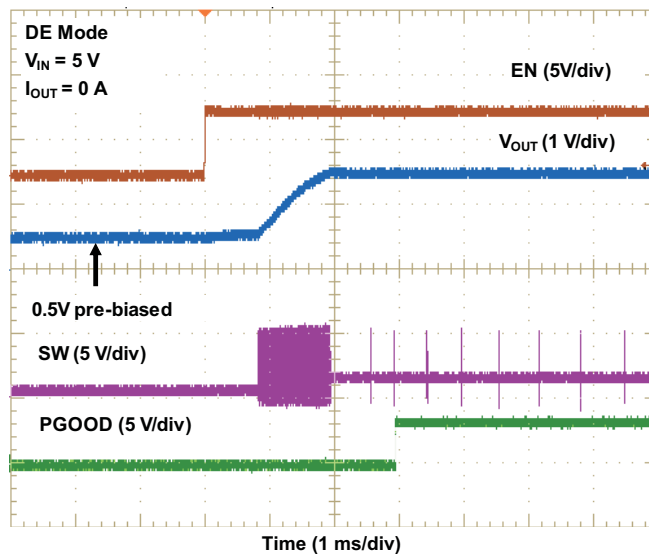

Figure 24. Pre-Biased Startup

TYPICAL CHARACTERISTICS (continued)

Inductor used: PCMC065T-1R0, 1 μ H, 5.6 m Ω

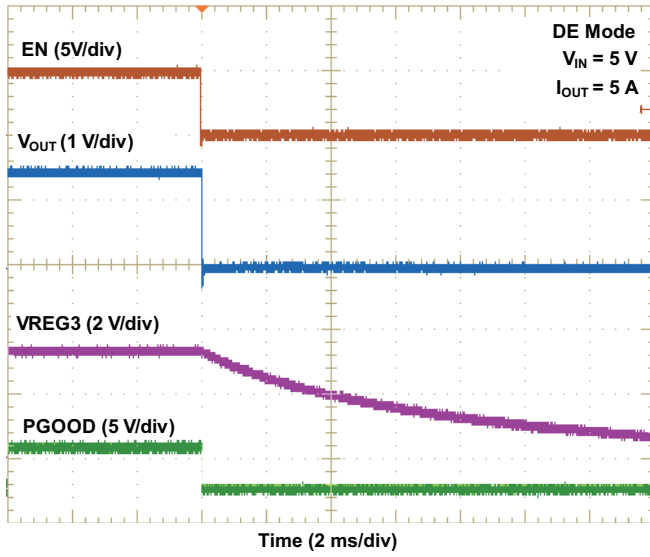

Figure 25. Turn-Off Enable

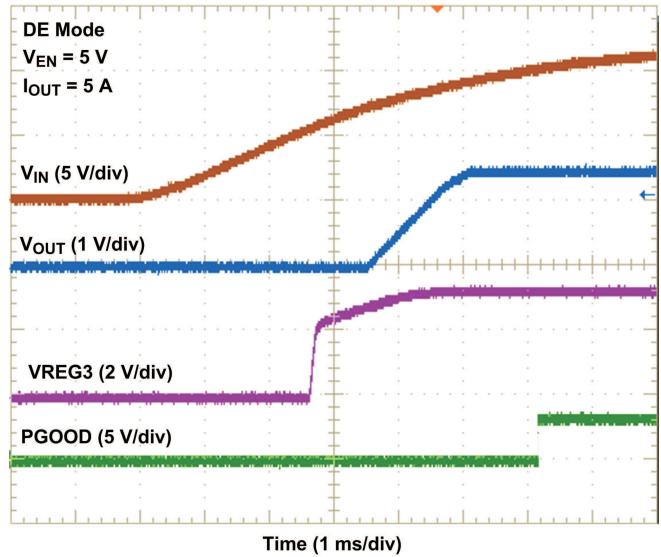

Figure 26. UVLO Start-Up Waveform

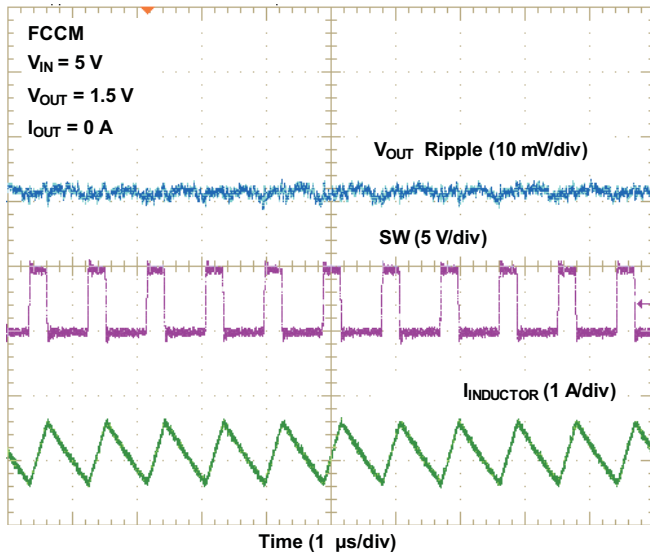

Figure 27. Output Voltage Ripple – FCCM

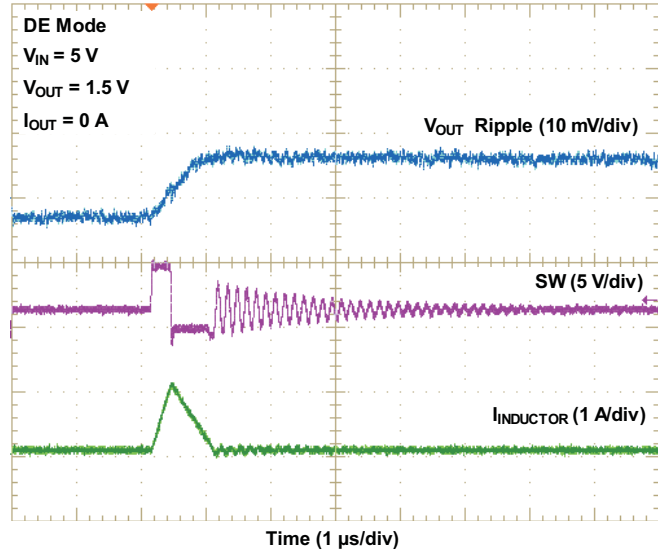

Figure 28. Output Voltage Ripple – DE Mode

TYPICAL CHARACTERISTICS (continued)

Inductor used: PCMC065T-1R0, 1 μ H, 5.6 m Ω

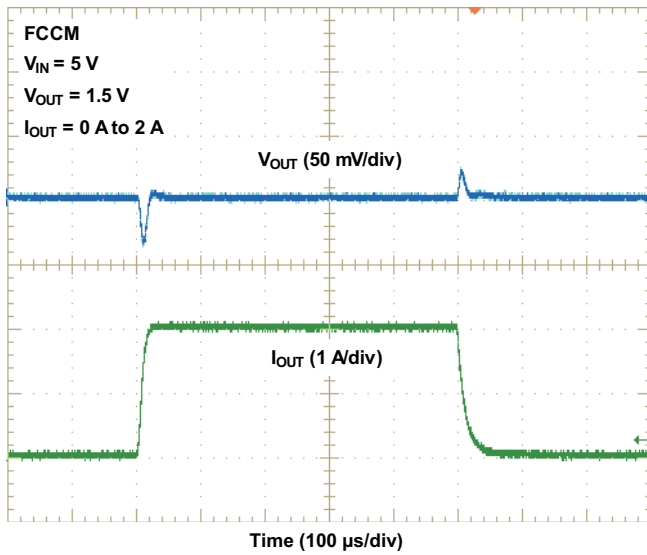

Figure 29. Load Transient – FCCM

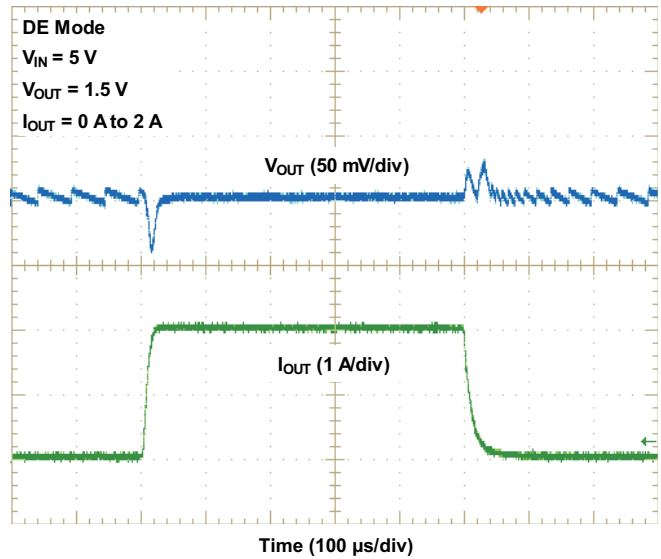

Figure 30. Load Transient – DE Mode

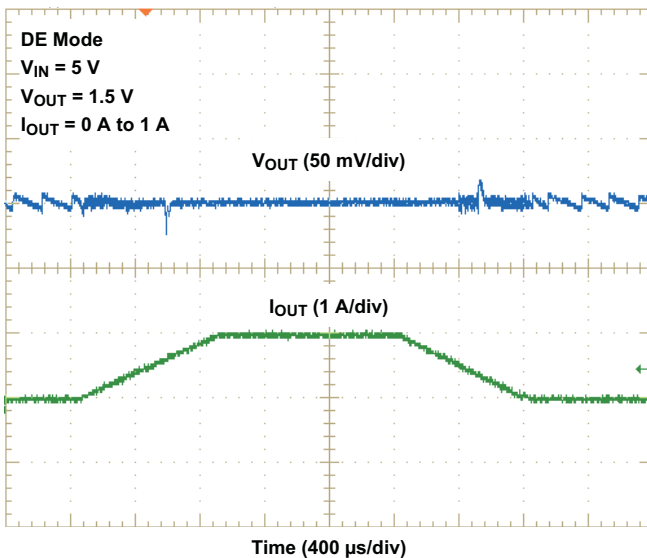

Figure 31. DE Mode DCM and CCM Transition

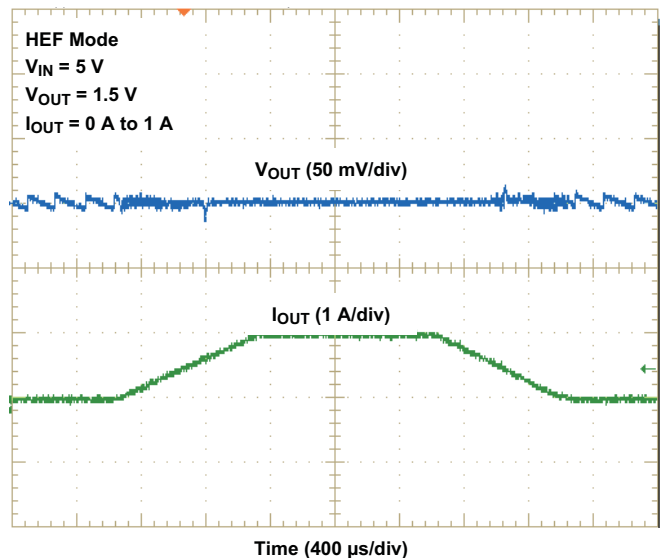

Figure 32. HEF Mode DCM and CCM Transition

TYPICAL CHARACTERISTICS (continued)

Inductor used: PCMC065T-1R0, 1 μ H, 5.6 m Ω

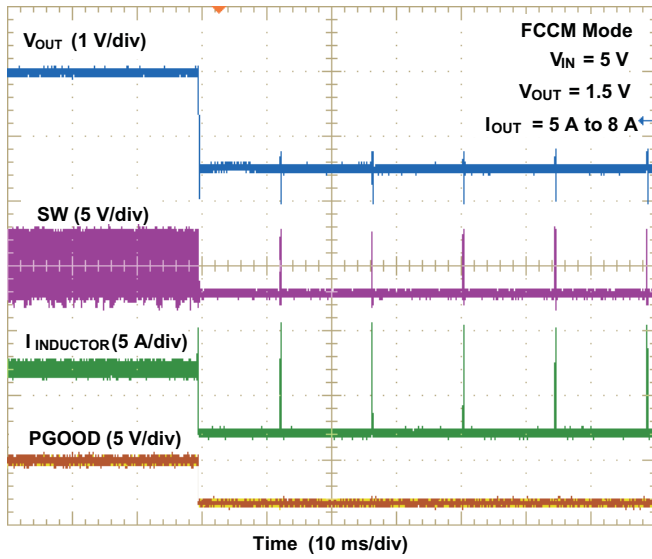

Figure 33. Overcurrent Protection

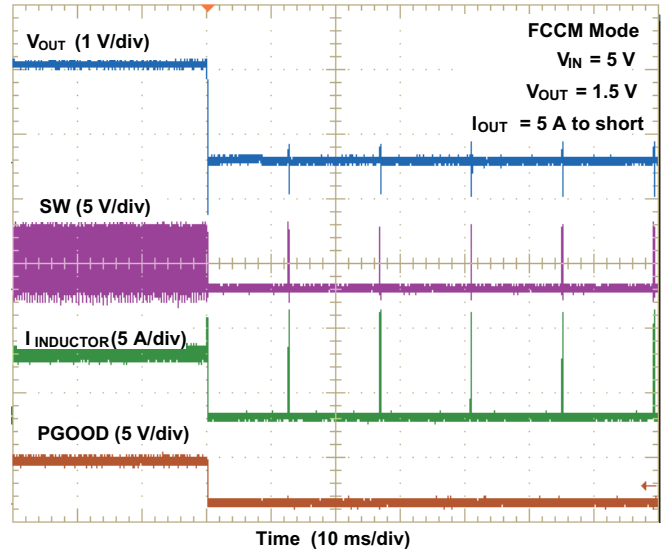

Figure 34. Short Circuit Protection

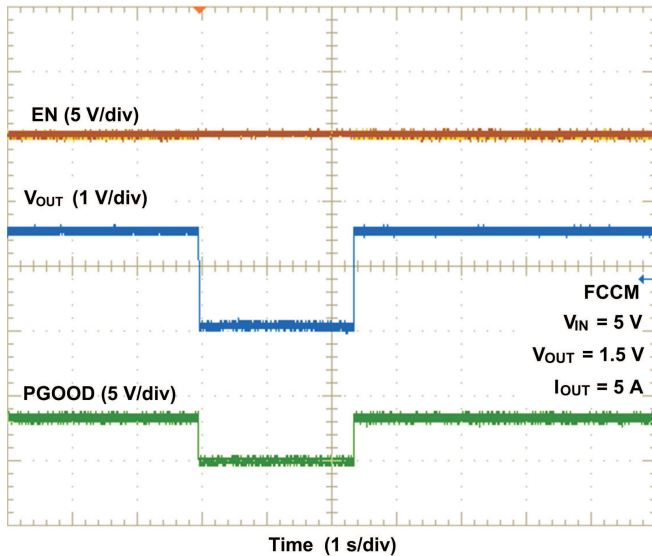

Figure 35. Over Temperature Protection

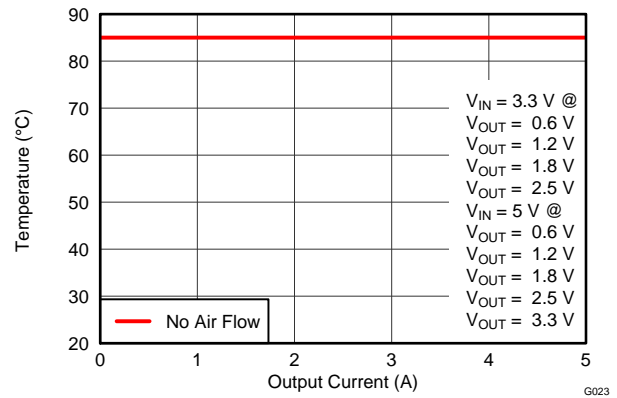

Figure 36. Safe Operating Area

APPLICATION INFORMATION

APPLICATION CIRCUIT DIAGRAM

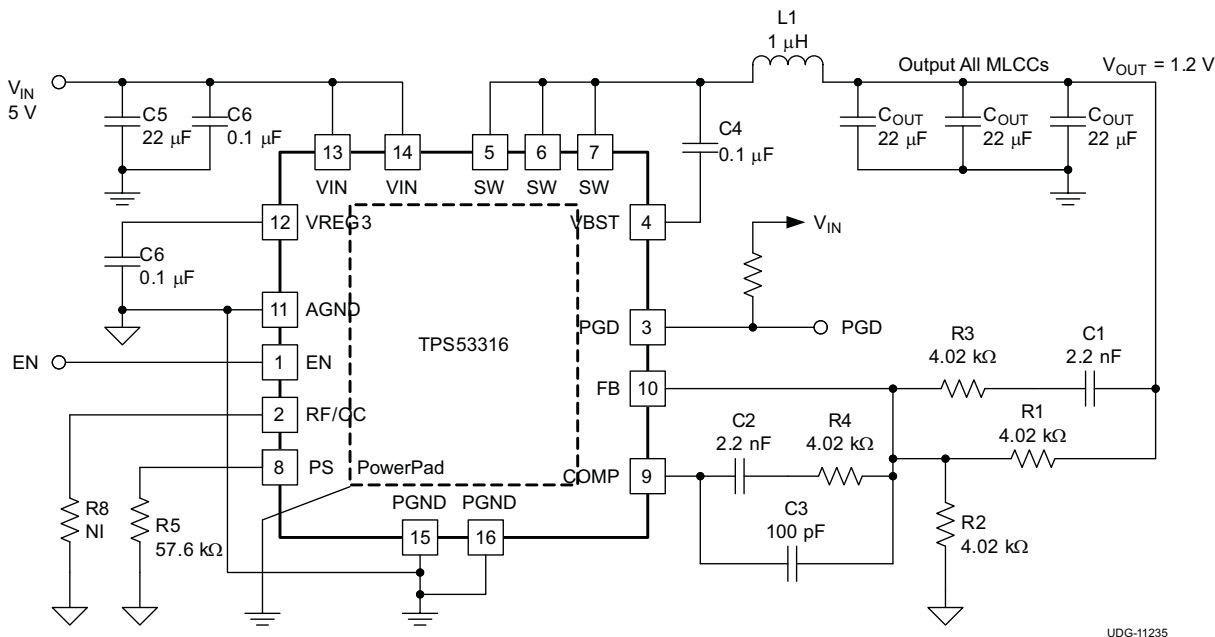

Figure 37. Typical 3.3V input Application Circuit Diagram

OVERVIEW

The TPS53316 is a high-efficiency switching regulator with two integrated N-channel MOSFETs and is capable of delivering up to 5 A of load current. The TPS53316 provides output voltage from 0.6 V up to 0.8 x VIN from 2.9V to 6.0V wide input voltage range.

This device employs 3 operation modes to fit into various application needs. The skip mode operation provides reduced power loss and increases the efficiency at light load. The unique, patented PWM modulator enables smooth light load to heavy load transition while maintaining fast load transient.

OVERCURRENT AND FREQUENCY SETTING

The Overcurrent and frequency setting are determined by RF/OC pin connection as shown in Table 1. At start up, the RF/OC pin sources 10 µA current and then sense the voltage on this pin to determine the switching frequency and OCP threshold.

Table 1. Overcurrent and Frequency Setting

RF/OC PIN CONNECTION	FREQUENCY (kHz)	OVERCURRENT THRESHOLD (A)
GND	1100	6.5
24.3 kΩ to GND	750	4.5
57.6 kΩ to GND	750	6.5
105 kΩ to GND	2000	4.5
174 kΩ to GND	2000	6.5
Floating or pulled to VREG3	1100	4.5

OPERATION MODE

The TPS53316 has 3 operation modes determined by PS connection as listed in [Table 2](#). Each mode has two soft-start and power good delay options (1× and 4×). At start-up, the PS pin sources 10 μA of current and then sense the voltage on this pin to determine the operation mode and soft-start time.

Table 2. Operation Mode Selection

PS PIN CONNECTION	OPERATION MODE	AUTO-SKIP AT LIGHT LOAD	SOFT-START TIME
GND	FCCM	No	4 x
24.3 kΩ to GND	HEF Mode	Yes	4 x
57.6 kΩ to GND	HEF Mode	Yes	1 x
105 kΩ to GND	DE Mode	Yes	1 x
174 kΩ to GND	DE Mode	Yes	4 x
Floating or pulled to VREG3	FCCM	No	1 x

In forced continuous conduction mode (FCCM), the high-side FET is ON during the on-time and low-side FET is ON during the off-time. The switching is synchronized to the internal clock thus the switching frequency is fixed.

In diode emulation mode (DE), the high-side FET is ON during the on-time and low-side FET is ON during the off-time until the inductor current reaches zero. An internal zero-crossing comparator detects the zero crossing of inductor current from positive to negative. When the inductor current reaches zero, the comparator sends a signal to the logic control and turns off the low-side FET.

When the load is increased, the inductor current is always positive and the zero-crossing comparator does not send a zero-crossing signal. The converter enters into continuous conduction mode (CCM) when no zero-crossing is detected for two consecutive PWM pulses. The switching is synchronized to the internal clock and the switching frequency is fixed.

In high-efficiency mode (HEF), the converter does not synchronize to internal clock during CCM. Instead, the PWM modulator determines the switching frequency. The operation in discontinuous conduction mode (DCM) is the same as DE mode.

In both DE and HEF modes, the device operates under CCM with fixed SW frequency if the load current is higher than half of the inductor ripple current. When the load current is decreased and seven consecutive zero-crossing events are detected, the device enters DCM and light load control is enabled. The on-pulse in DCM is designed to be 25% higher than CCM to provide hysteresis to avoid chattering between CCM and DCM.

The PS pins also set the soft-start time and power good start-up delay of the device. The nominal sort-start time is 400 μs from the time $V_{OUT} = 0$ V to when $V_{OUT} = 100\%$, and the nominal power good delay is 300 μs from the time $V_{OUT} = 100\%$ to when power good is asserted. When the PS pin is connected to GND directly or with a resistor with a value of 24.3 kΩ or 174 kΩ, the soft-start time and power good delay is 4 times the nominal (1.6 ms for soft-start time and 1.2 ms for power good delay).

LIGHT LOAD OPERATION

In skip modes (DE and HEF), when the load current is less than half of inductor ripple current, the inductor current reaches zero by the end of OFF-Time. The light load control scheme then turns off the low-side MOSFET when inductor current reaches zero. Since there is no negative inductor current, the energy delivered to the load per switching cycle is increased compared to the normal PWM mode operation. The controller then reduces the switching frequency to maintain the output voltage regulation. The switching loss is reduced and thus efficiency is improved.

In both DE and HEF mode, when the load current decreases, the switching frequency also decreases continuously in discontinuous conduction mode (DCM). When the load current is 0 A, the minimum switching frequency is reached. It is also required that the difference between V_{VBST} and V_{SW} to be higher than 2.4 V to ensure the supply for high-side gate driver.

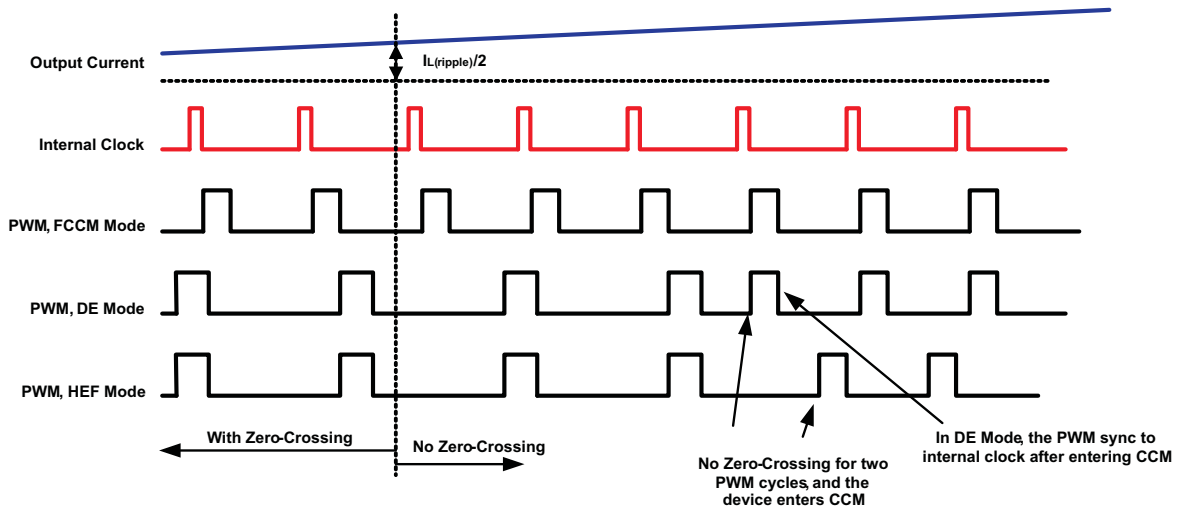

UDG-11269

Figure 38. TPS53316 Operation Modes in Light and Heavy Load Conditions

FORCED CONTINUOUS CONDUCTION MODE

When the PS pin is grounded or greater than 2.2 V, the TPS53316 is operating in continuous conduction mode in both light and heavy load condition. In this mode, the switching frequency remains constant over the entire load range which is suitable for applications need tight control of switching frequency at a cost of lower efficiency at light load.

SOFT-START OPERATION

The soft-start operation reduces the inrush current during the start-up time. A slow rising reference is generated by the soft-start circuitry and send to the input of the error amplifier. When the soft-start ramp voltage is less than 600 mV, the error amplifier uses this ramp voltage as the reference. When the ramp voltage reaches 600 mV, the error amplifier switch to a fixed 600 mV reference. The typical soft-start time is 400 μ s for 1 \times soft-start time setting and 1.6 ms for 4 \times the soft-start time setting.

POWER GOOD

The TPS53316 monitors the voltage on the FB pin. If the FB voltage is within 117% and 83% of the reference voltage, the power good signal remains high. If FB voltage is out of this window, power good pin is pulled low by the internal open drain output.

During start-up operation, the input voltage must be higher than 1 V in order to have valid power good logic, and the power good signal has 300 μ s (1.2 ms with 4x setting) delay after FB falling into the power good window. There is also 10- μ s delay during shut down after FB falling out of the power good window.

UVLO FUNCTION

The TPS53316 provides UVLO protection for input voltage. If the input voltage is higher than UVLO threshold voltage, the device starts up. When the voltage becomes lower than the threshold voltage minus the hysteresis, the device shuts off. The typical UVLO rising threshold is 2.8 V and the hysteresis is 130 mV.

A similar UVLO function is provided to the VREG3 pin. The typical UVLO rising threshold is 2.8V and the hysteresis is 75 mV for VREG3.

OVERCURRENT PROTECTION

The TPS53316 continuously monitors the current flowing through high-side and low-side MOSFETs. If the current through the high-side FET exceeds 6.8 A (or 4.5 A with 4.5 A setting), the high-side FET turns off and the low-side FET turns on. An OC counter starts to increment to count the occurrence of the overcurrent events. The converter shuts down immediately when the OC counter reaches 4. The OC counter resets if the detected current is less 6.8 A after an OC event.

Another set of overcurrent circuitry monitors the current through low-side FET. If the current through the low-side FET exceeds 7.5 A (or 5.1 A with 4.5 A setting), the overcurrent protection is engaged and turns off both high-side and low-side FETs immediately. The device is fully protected against overcurrent during both on-time and off-time.

After an OCP event, the device will attempt to restart after a hiccup delay (14.5 ms typical). If the OC condition clears before restart, the device starts up normally. Otherwise the hiccup process repeats.

OVERVOLTAGE PROTECTION

The TPS53316 monitors the voltage divided feedback voltage to detect the overvoltage and undervoltage conditions. When the feedback voltage is greater than 117% of the reference, the high-side MOSFET turns off and the low-side MOSFET turns on. Then the output voltage drops and reaches the undervoltage threshold. At that point the low-side MOSFET turns off and the device enters high-impedance state.

UNDERVOLTAGE PROTECTION

When the feedback voltage is lower than 83% of the reference voltage, the undervoltage protection counter starts. If the feedback voltage remains lower than the undervoltage threshold voltage after 10 μ s, the device turns off both high-side and low-side MOSFETs and enters high-impedance state. After a hiccup delay (14.5 ms typical), the device attempts to restart. If the UV condition clears before restart, the device starts up normally. Otherwise the hiccup process repeats.

OVERTEMPERATURE PROTECTION

The TPS53316 continuously monitors the die temperature. If the die temperature exceeds the threshold value (140°C typical), the device shuts off. When the device is cooled to 40°C below the overtemperature threshold, it restarts and returns to normal operation.

OUTPUT DISCHARGE

When the EN pin is low, the TPS53316 discharges the output capacitors through an internal MOSFET switch between SW and GND while the high-side and low-side MOSFETs remain OFF. The typical discharge switch on resistance is 60 Ω . This function is disabled when the input voltage is less than 1 V.

EXTERNAL COMPONENTS SELECTION

Step One: Determine the Value of R1 and R2

The output voltage is programmed by the voltage-divider resistor, R1 and R2 shown in [Figure 37](#). R1 is connected between VFB pin and the output, and R2 is connected between the VFB pin and GND. Recommended value for R1 is between 1 kΩ and 10 kΩ. Determine R2 using [Equation 1](#).

$$R2 = \frac{0.6}{V_{OUT} - 0.6} \times R1 \quad (1)$$

Step Two: Choose the Inductor

The inductance value should be determined to give the ripple current of approximately 20% to 40% of maximum output current. The inductor ripple current is determined by [Equation 2](#):

$$I_{L(\text{ripple})} = \frac{1}{L \times f_{SW}} \times \frac{(V_{IN} - V_{OUT}) \times V_{OUT}}{V_{IN}} \quad (2)$$

The inductor also must have a low DCR to achieve good efficiency, as well as enough room above peak inductor current before saturation.

Step Three: Choose the Output Capacitor(s)

The output capacitor selection is determined by output ripple and transient requirement. When operating in CCM, the output ripple has three components. $V_{RIPPLE(C)}$ represents the ripple due to the output capacitance and is shown in [Equation 4](#).

$$V_{RIPPLE} = V_{RIPPLE(C)} + V_{RIPPLE(ESR)} + V_{RIPPLE(ESL)} \quad (3)$$

$$V_{RIPPLE(C)} = \frac{I_{L(\text{ripple})}}{8 \times C_{OUT} \times f_{SW}} \quad (4)$$

$$V_{RIPPLE(ESR)} = I_{L(\text{ripple})} \times ESR \quad (5)$$

$$V_{RIPPLE(ESL)} = \frac{V_{IN} \times ESL}{L} \quad (6)$$

When ceramic output capacitor is chosen, the ESL component is usually negligible. In the case when multiple output capacitors are used, the total ESR and ESL should be the equivalent of the all output capacitors in parallel.

When operating in DCM, the output ripple is dominated by the component determined by capacitance. It also varies with load current and can be expressed as shown in [Equation 7](#).

$$V_{RIPPLE(DCM)} = \frac{(\alpha \times I_{L(\text{ripple})} - I_{OUT})^2}{2 \times f_{SW} \times C_{OUT} \times I_{L(\text{ripple})}}$$

where

- α is the DCM on-time coefficient (typical value is 1.25) and can be expressed as
$$\alpha = \frac{t_{ON(DCM)}}{t_{ON(CCM)}} \quad (7)$$

[Figure 39](#) illustrates the DCM output voltage ripple.

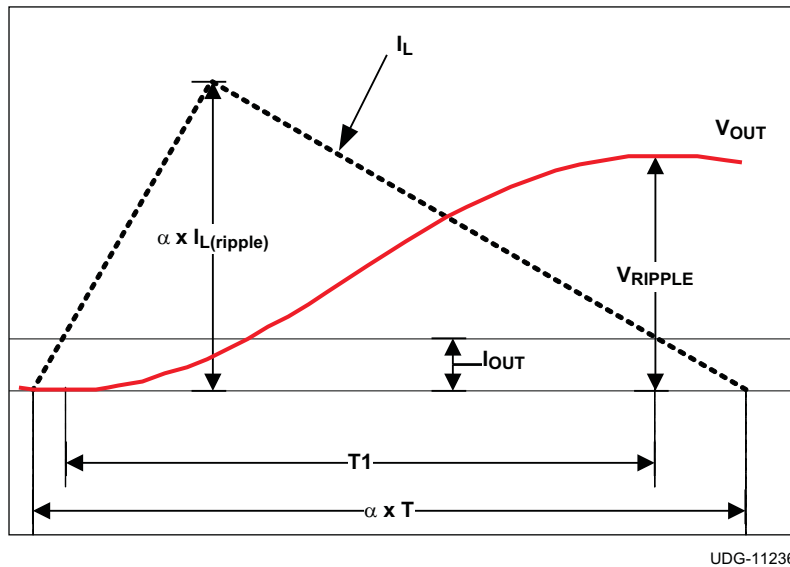

Figure 39. Discontinuous Mode Output Voltage Ripple

Step Four: Choose the Input Capacitors

The selection of input capacitor should be determined by the ripple current requirement. The ripple current generated by the converter needs to be absorbed by the input capacitors as well as the input source. The RMS ripple current from the converter can be expressed as shown in [Equation 8](#).

$$I_{IN(ripple)} = I_{OUT} \times \sqrt{D \times (1 - D)}$$

where

$$D = \frac{V_{OUT}}{V_{IN}} \quad (8)$$

- D is the duty cycle and can be expressed as

To minimize the ripple current drawn from the input source, sufficient input decoupling capacitors should be placed close to the device. The ceramic capacitor is recommended due to the low ESR and low ESL. The input voltage ripple can be calculated as below when the total input capacitance is determined:

$$V_{IN(ripple)} = \frac{I_{OUT} \times D}{f_{SW} \times C_{IN}} \quad (9)$$

Compensation Design

The TPS53316 employs voltage mode control. To effectively compensation the power stage and ensures fast transient response, Type III compensation is typically used.

The control to output transfer function can be described in [Equation 10](#).

$$G_{CO} = 4 \times \frac{1 + s \times C_{OUT} \times ESR}{1 + s \times \left(\frac{L}{DCR + R_{LOAD}} + C_{OUT} \times (ESR + DCR) \right) + s^2 \times L \times C_{OUT}} \quad (10)$$

The output LC filter introduces a double pole which can be calculated in [Equation 11](#).

$$f_{DP} = \frac{1}{2 \times \pi \times \sqrt{L \times C_{OUT}}} \quad (11)$$

The ESR zero of can be calculated in [Equation 12](#).

$$f_{ESR} = \frac{1}{2 \times \pi \times ESR \times C_{OUT}} \quad (12)$$

Figure 40 shows the configuration of Type III compensation and typical pole and zero locations. The following equations describe the compensator transfer function and poles and zeros of the Type III network.

$$G_{EA} = \frac{(1 + s \times C1 \times (R1 + R3))(1 + s \times R4 \times C2)}{(s \times R1 \times (C2 + C3)) \times (1 + s \times C1 \times R3) \times \left(1 + s \times R4 \times \frac{C2 \times C3}{C2 + C3}\right)} \quad (13)$$

$$f_{Z1} = \frac{1}{2 \times \pi \times R4 \times C2} \quad (14)$$

$$f_{Z2} = \frac{1}{2 \times \pi \times (R1 + R3) \times C1} \cong \frac{1}{2 \times \pi \times R1 \times C1} \quad (15)$$

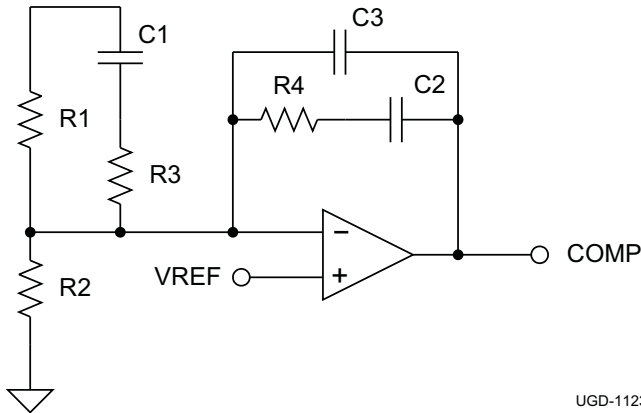

UGD-11238

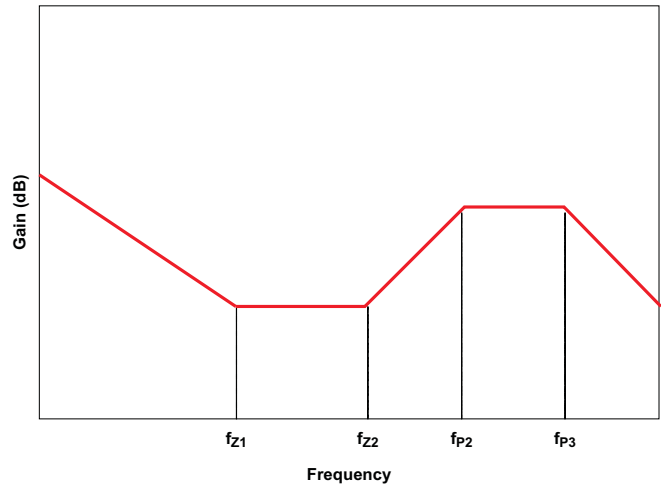

UDG-11237

Figure 40. Type III Compensation Network Schematic

Figure 41. Type III Compensation Network Waveform

$$f_{P1} = 0 \quad (16)$$

$$f_{P2} = \frac{1}{2 \times \pi \times R3 \times C1} \quad (17)$$

$$f_{P3} = \frac{1}{2 \times \pi \times R4 \times \left(\frac{C2 \times C3}{C2 + C3}\right)} \cong \frac{1}{2 \times \pi \times R4 \times C3} \quad (18)$$

The two zeros can be placed near the double pole frequency to cancel the response from the double pole. One pole can be used to cancel ESR zero, and the other non-zero pole can be placed at half switching frequency to attenuate the high frequency noise and switching ripple. Suitable values can be selected to achieve a compromise between high phase margin and fast response. A phase margin higher than 45° is required for stable operation.

For DCM operation, a C3 capacitor value between 56 pF and 150 pF is recommended for output capacitance between 20 µF to 200 µF.

LAYOUT CONSIDERATIONS

Good layout is essential for stable power supply operation. Follow these guidelines for an efficient PCB layout:

- Separate the power ground and analog ground. Connect analog ground to GND plane with single via or a 0 Ω resistor at a quiet place.
- Use 4 vias to connect the thermal pad to power ground.
- Place VIN and VREG3 decoupling capacitors as close to the device as possible.
- Use wide traces for VIN, VOUT, PGND and SW. These nodes carry high-current and also serve as heat sinks.
- Place feedback and compensation components as close to the device as possible.
- Keep analog signals (FB, COMP) away from noisy signals (SW, VBST).
- Refer to TPS53316 evaluation kit for a layout example.

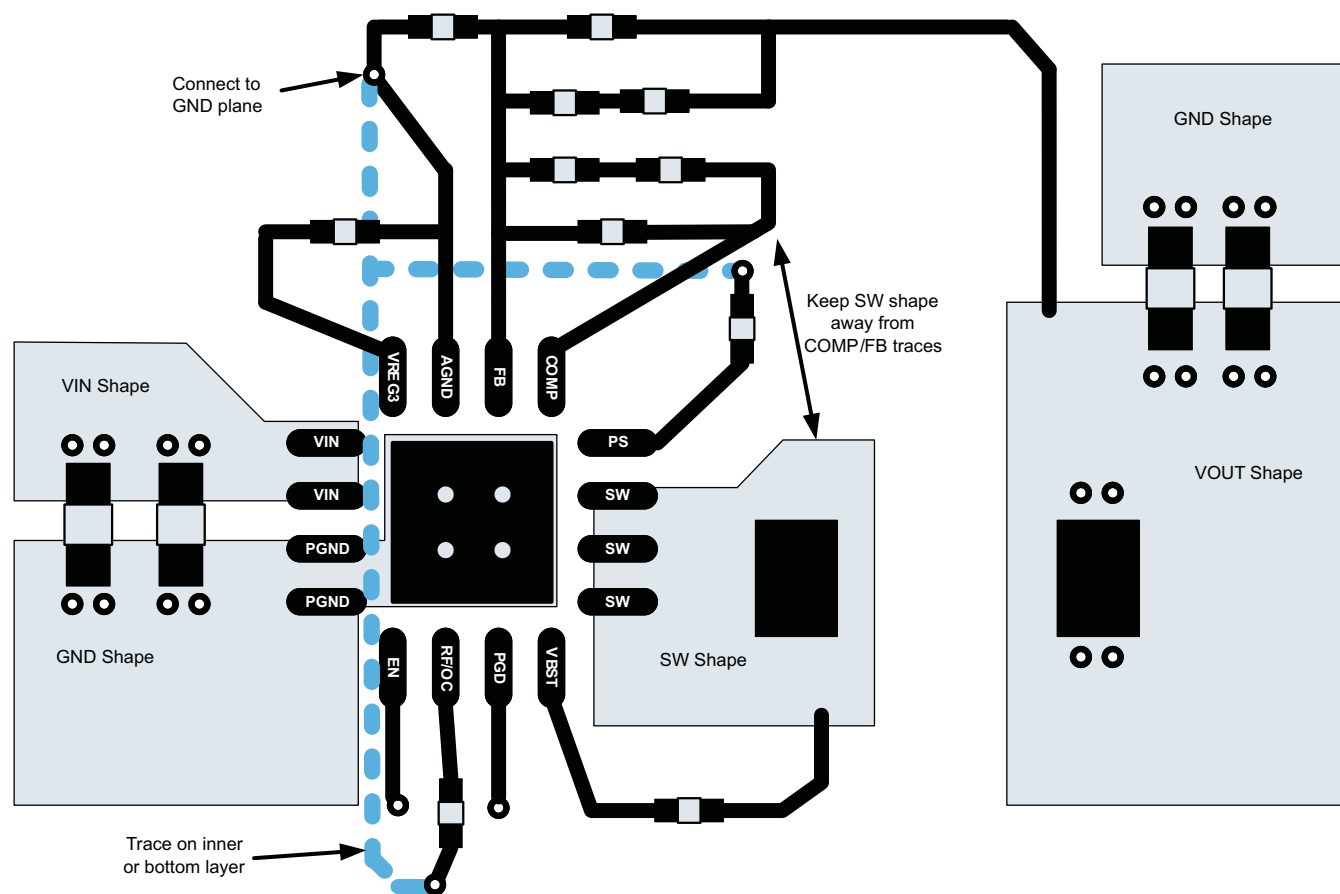

UDG-11270

Figure 42. Layout Guidelines

PACKAGING INFORMATION

Orderable Device	Status (1)	Package Type	Package Drawing	Pins	Package Qty	Eco Plan (2)	Lead/Ball Finish	MSL Peak Temp (3)	Op Temp (°C)	Top-Side Markings (4)	Samples
TPS53316RGTR	ACTIVE	QFN	RGT	16	3000	Green (RoHS & no Sb/Br)	CU NIPDAU	Level-2-260C-1 YEAR	-40 to 85	3316	Samples
TPS53316RGTT	ACTIVE	QFN	RGT	16	250	Green (RoHS & no Sb/Br)	CU NIPDAU	Level-2-260C-1 YEAR	-40 to 85	3316	Samples

(1) The marketing status values are defined as follows:

ACTIVE: Product device recommended for new designs.

LIFEBUY: TI has announced that the device will be discontinued, and a lifetime-buy period is in effect.

NRND: Not recommended for new designs. Device is in production to support existing customers, but TI does not recommend using this part in a new design.

PREVIEW: Device has been announced but is not in production. Samples may or may not be available.

OBSOLETE: TI has discontinued the production of the device.

(2) Eco Plan - The planned eco-friendly classification: Pb-Free (RoHS), Pb-Free (RoHS Exempt), or Green (RoHS & no Sb/Br) - please check <http://www.ti.com/productcontent> for the latest availability information and additional product content details.

TBD: The Pb-Free/Green conversion plan has not been defined.

Pb-Free (RoHS): TI's terms "Lead-Free" or "Pb-Free" mean semiconductor products that are compatible with the current RoHS requirements for all 6 substances, including the requirement that lead not exceed 0.1% by weight in homogeneous materials. Where designed to be soldered at high temperatures, TI Pb-Free products are suitable for use in specified lead-free processes.

Pb-Free (RoHS Exempt): This component has a RoHS exemption for either 1) lead-based flip-chip solder bumps used between the die and package, or 2) lead-based die adhesive used between the die and leadframe. The component is otherwise considered Pb-Free (RoHS compatible) as defined above.

Green (RoHS & no Sb/Br): TI defines "Green" to mean Pb-Free (RoHS compatible), and free of Bromine (Br) and Antimony (Sb) based flame retardants (Br or Sb do not exceed 0.1% by weight in homogeneous material)

(3) MSL, Peak Temp. -- The Moisture Sensitivity Level rating according to the JEDEC industry standard classifications, and peak solder temperature.

(4) Multiple Top-Side Markings will be inside parentheses. Only one Top-Side Marking contained in parentheses and separated by a "~" will appear on a device. If a line is indented then it is a continuation of the previous line and the two combined represent the entire Top-Side Marking for that device.

Important Information and Disclaimer: The information provided on this page represents TI's knowledge and belief as of the date that it is provided. TI bases its knowledge and belief on information provided by third parties, and makes no representation or warranty as to the accuracy of such information. Efforts are underway to better integrate information from third parties. TI has taken and continues to take reasonable steps to provide representative and accurate information but may not have conducted destructive testing or chemical analysis on incoming materials and chemicals. TI and TI suppliers consider certain information to be proprietary, and thus CAS numbers and other limited information may not be available for release.

In no event shall TI's liability arising out of such information exceed the total purchase price of the TI part(s) at issue in this document sold by TI to Customer on an annual basis.

TAPE AND REEL INFORMATION

QUADRANT ASSIGNMENTS FOR PIN 1 ORIENTATION IN TAPE

*All dimensions are nominal

Device	Package Type	Package Drawing	Pins	SPQ	Reel Diameter (mm)	Reel Width W1 (mm)	A0 (mm)	B0 (mm)	K0 (mm)	P1 (mm)	W (mm)	Pin1 Quadrant
TPS53316RGTR	QFN	RGT	16	3000	330.0	12.4	3.3	3.3	1.1	8.0	12.0	Q2
TPS53316RGTT	QFN	RGT	16	250	180.0	12.4	3.3	3.3	1.1	8.0	12.0	Q2

TAPE AND REEL BOX DIMENSIONS

*All dimensions are nominal

Device	Package Type	Package Drawing	Pins	SPQ	Length (mm)	Width (mm)	Height (mm)
TPS53316RGTR	QFN	RGT	16	3000	367.0	367.0	35.0
TPS53316RGTT	QFN	RGT	16	250	210.0	185.0	35.0

RGT (S-PVQFN-N16)

PLASTIC QUAD FLATPACK NO-LEAD

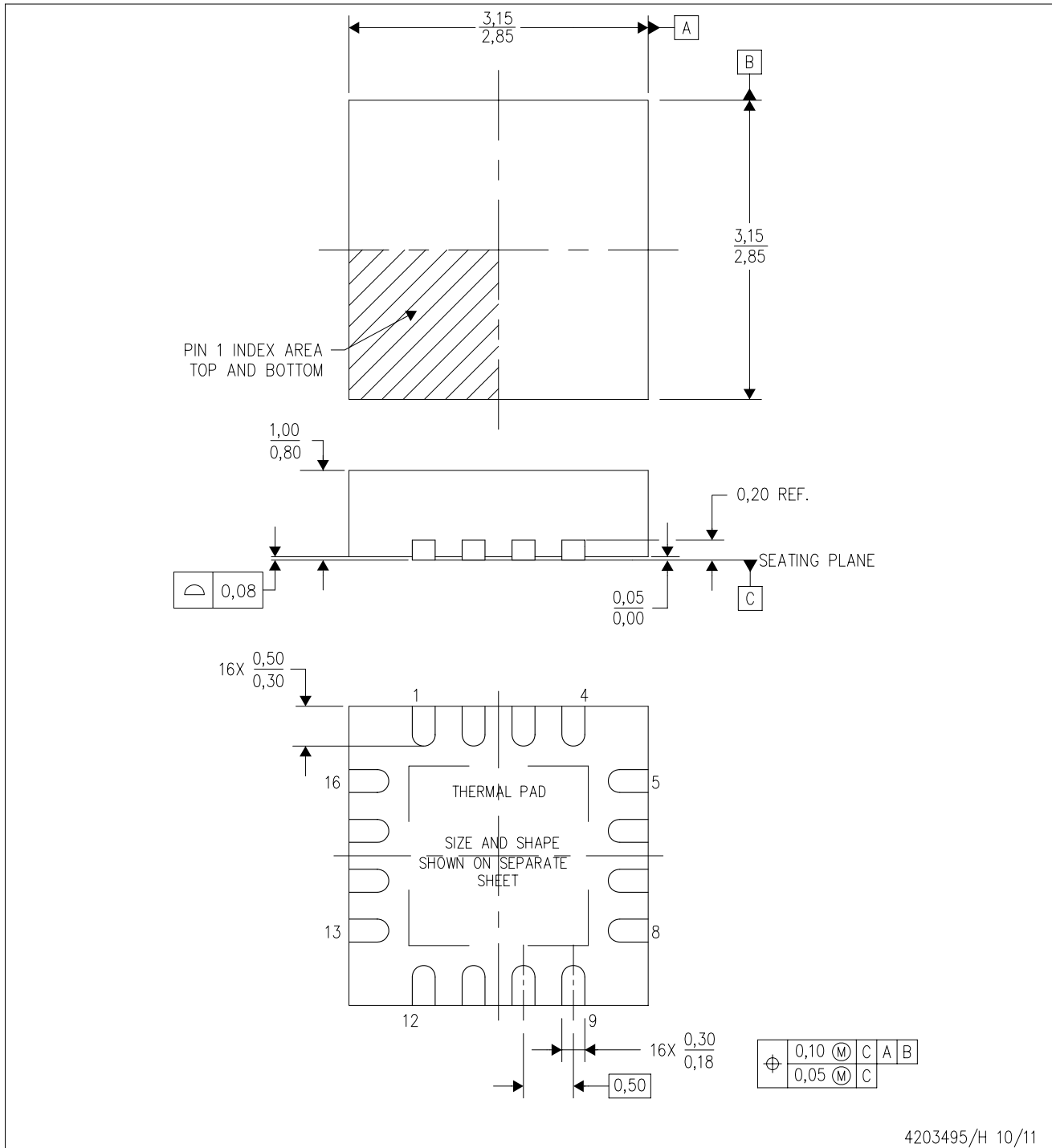

4203495/H 10/11

- NOTES:
- All linear dimensions are in millimeters. Dimensioning and tolerancing per ASME Y14.5M-1994.
 - This drawing is subject to change without notice.
 - Quad Flatpack, No-leads (QFN) package configuration.
 - The package thermal pad must be soldered to the board for thermal and mechanical performance.
 - See the additional figure in the Product Data Sheet for details regarding the exposed thermal pad features and dimensions.
 - Falls within JEDEC MO-220.

THERMAL PAD MECHANICAL DATA

RGT (S-PVQFN-N16)

PLASTIC QUAD FLATPACK NO-LEAD

THERMAL INFORMATION

This package incorporates an exposed thermal pad that is designed to be attached directly to an external heatsink. The thermal pad must be soldered directly to the printed circuit board (PCB). After soldering, the PCB can be used as a heatsink. In addition, through the use of thermal vias, the thermal pad can be attached directly to the appropriate copper plane shown in the electrical schematic for the device, or alternatively, can be attached to a special heatsink structure designed into the PCB. This design optimizes the heat transfer from the integrated circuit (IC).

For information on the Quad Flatpack No-Lead (QFN) package and its advantages, refer to Application Report, QFN/SON PCB Attachment, Texas Instruments Literature No. SLUA271. This document is available at www.ti.com.

The exposed thermal pad dimensions for this package are shown in the following illustration.

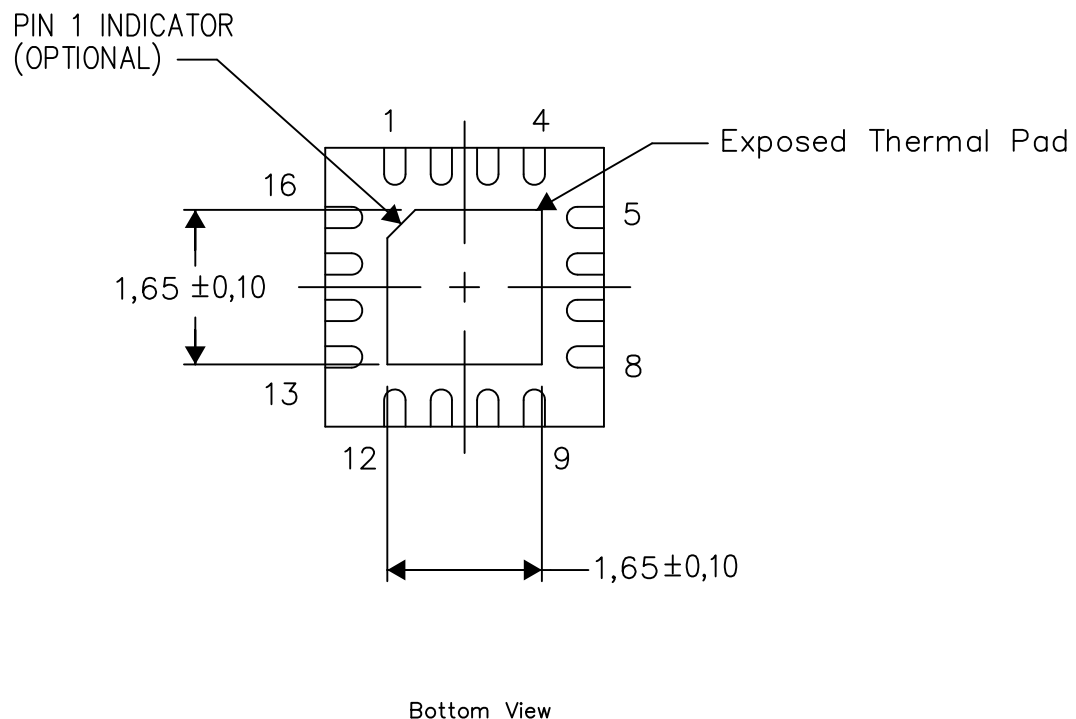

Exposed Thermal Pad Dimensions

4206349-7/Z 08/15

NOTE: All linear dimensions are in millimeters

RGT (S-PVQFN-N16)

PLASTIC QUAD FLATPACK NO-LEAD

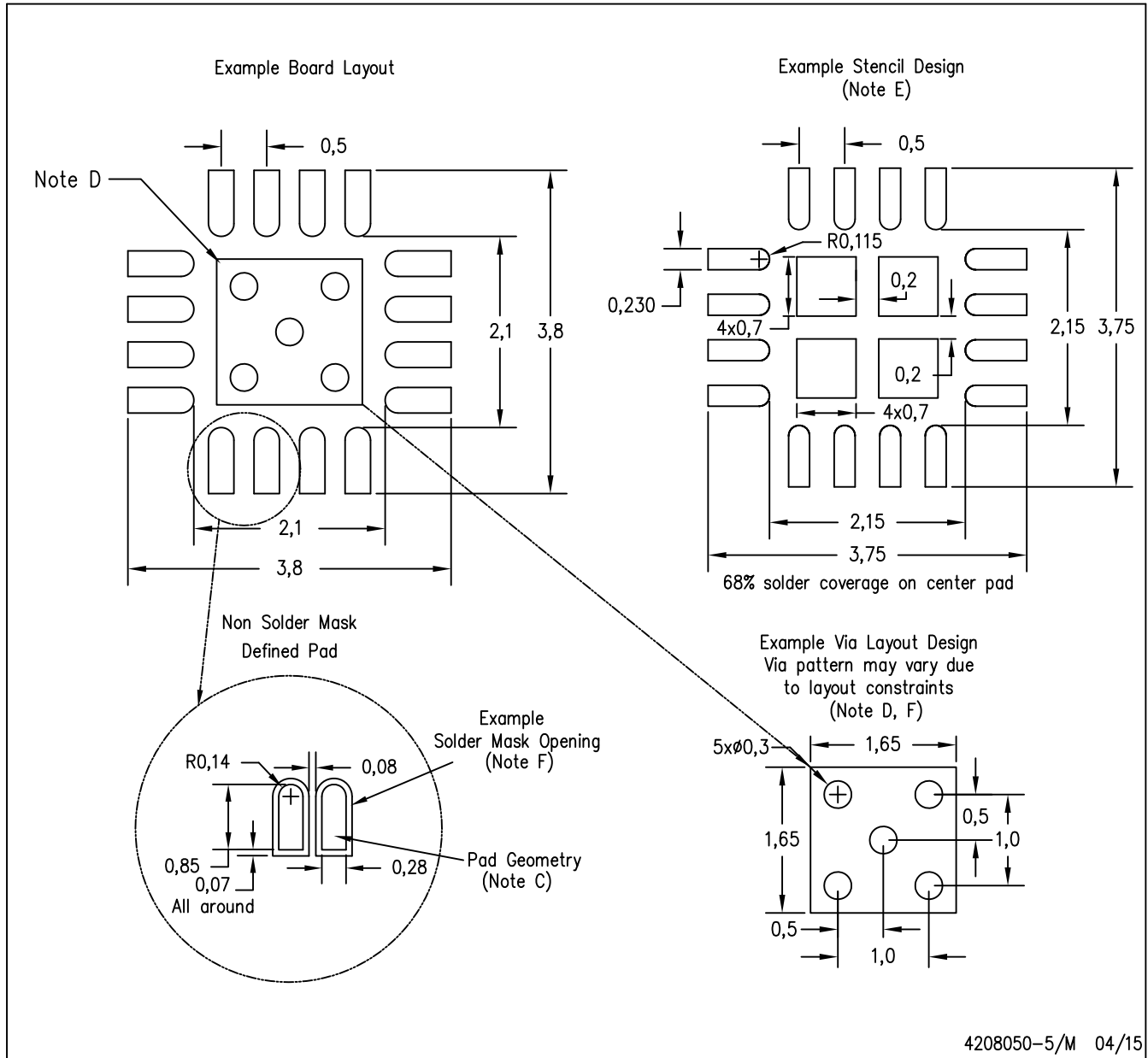

- NOTES:
- A. All linear dimensions are in millimeters.
 - B. This drawing is subject to change without notice.
 - C. Publication IPC-7351 is recommended for alternate designs.
 - D. This package is designed to be soldered to a thermal pad on the board. Refer to Application Note, QFN/SON PCB Attachment, Texas Instruments Literature No. SLUA271, and also the Product Data Sheets for specific thermal information, via requirements, and recommended board layout. These documents are available at www.ti.com <<http://www.ti.com>>.
 - E. Laser cutting apertures with trapezoidal walls and also rounding corners will offer better paste release. Customers should contact their board assembly site for stencil design recommendations. Refer to IPC 7525 for stencil design considerations.
 - F. Customers should contact their board fabrication site for minimum solder mask web tolerances between signal pads.

IMPORTANT NOTICE

Texas Instruments Incorporated and its subsidiaries (TI) reserve the right to make corrections, enhancements, improvements and other changes to its semiconductor products and services per JESD46, latest issue, and to discontinue any product or service per JESD48, latest issue. Buyers should obtain the latest relevant information before placing orders and should verify that such information is current and complete. All semiconductor products (also referred to herein as "components") are sold subject to TI's terms and conditions of sale supplied at the time of order acknowledgment.

TI warrants performance of its components to the specifications applicable at the time of sale, in accordance with the warranty in TI's terms and conditions of sale of semiconductor products. Testing and other quality control techniques are used to the extent TI deems necessary to support this warranty. Except where mandated by applicable law, testing of all parameters of each component is not necessarily performed.

TI assumes no liability for applications assistance or the design of Buyers' products. Buyers are responsible for their products and applications using TI components. To minimize the risks associated with Buyers' products and applications, Buyers should provide adequate design and operating safeguards.

TI does not warrant or represent that any license, either express or implied, is granted under any patent right, copyright, mask work right, or other intellectual property right relating to any combination, machine, or process in which TI components or services are used. Information published by TI regarding third-party products or services does not constitute a license to use such products or services or a warranty or endorsement thereof. Use of such information may require a license from a third party under the patents or other intellectual property of the third party, or a license from TI under the patents or other intellectual property of TI.

Reproduction of significant portions of TI information in TI data books or data sheets is permissible only if reproduction is without alteration and is accompanied by all associated warranties, conditions, limitations, and notices. TI is not responsible or liable for such altered documentation. Information of third parties may be subject to additional restrictions.

Resale of TI components or services with statements different from or beyond the parameters stated by TI for that component or service voids all express and any implied warranties for the associated TI component or service and is an unfair and deceptive business practice. TI is not responsible or liable for any such statements.

Buyer acknowledges and agrees that it is solely responsible for compliance with all legal, regulatory and safety-related requirements concerning its products, and any use of TI components in its applications, notwithstanding any applications-related information or support that may be provided by TI. Buyer represents and agrees that it has all the necessary expertise to create and implement safeguards which anticipate dangerous consequences of failures, monitor failures and their consequences, lessen the likelihood of failures that might cause harm and take appropriate remedial actions. Buyer will fully indemnify TI and its representatives against any damages arising out of the use of any TI components in safety-critical applications.

In some cases, TI components may be promoted specifically to facilitate safety-related applications. With such components, TI's goal is to help enable customers to design and create their own end-product solutions that meet applicable functional safety standards and requirements. Nonetheless, such components are subject to these terms.

No TI components are authorized for use in FDA Class III (or similar life-critical medical equipment) unless authorized officers of the parties have executed a special agreement specifically governing such use.

Only those TI components which TI has specifically designated as military grade or "enhanced plastic" are designed and intended for use in military/aerospace applications or environments. Buyer acknowledges and agrees that any military or aerospace use of TI components which have **not** been so designated is solely at the Buyer's risk, and that Buyer is solely responsible for compliance with all legal and regulatory requirements in connection with such use.

TI has specifically designated certain components as meeting ISO/TS16949 requirements, mainly for automotive use. In any case of use of non-designated products, TI will not be responsible for any failure to meet ISO/TS16949.

Products

Audio	www.ti.com/audio
Amplifiers	amplifier.ti.com
Data Converters	dataconverter.ti.com
DLP® Products	www.dlp.com
DSP	dsp.ti.com
Clocks and Timers	www.ti.com/clocks
Interface	interface.ti.com
Logic	logic.ti.com
Power Mgmt	power.ti.com
Microcontrollers	microcontroller.ti.com
RFID	www.ti-rfid.com
OMAP Applications Processors	www.ti.com/omap
Wireless Connectivity	www.ti.com/wirelessconnectivity

Applications

Automotive and Transportation	www.ti.com/automotive
Communications and Telecom	www.ti.com/communications
Computers and Peripherals	www.ti.com/computers
Consumer Electronics	www.ti.com/consumer-apps
Energy and Lighting	www.ti.com/energy
Industrial	www.ti.com/industrial
Medical	www.ti.com/medical
Security	www.ti.com/security
Space, Avionics and Defense	www.ti.com/space-avionics-defense
Video and Imaging	www.ti.com/video

TI E2E Community

e2e.ti.com