

3-A SINK/SOURCE DDR TERMINATION REGULATOR

FEATURES

- Input Voltage Range: 4.75 V to 5.25 V
- VLDOIN Voltage Range: 1.2 V to 3.6 V
- 3-A Sink/Source Termination Regulator Includes Droop Compensation
- Requires Only 20- μ F Ceramic Output Capacitance
- Supports High-Z in S3 and Soft-Off in S5
- 1.2-V Input (VLDOIN) Helps Reduce Total Power Dissipation
- Integrated Divider Tracks $\frac{1}{2}VDDQSNS$ for VTT and VTTREF
- Remote Sensing (VTTSENS)
- ± 20 -mV Accuracy for VTT and VTTREF
- 10-mA Buffered Reference (VTTREF)
- Built-In Soft-Start, UVLO and OCL
- Thermal Shutdown
- Supports JEDEC Specifications

APPLICATIONS

- DDR, DDR2 Memory Termination
- SSTL-2, SSTL-18 and HSTL Termination

DESCRIPTION

The TPS51100 is a 3-A sink/source tracking termination regulator. It is specifically designed for low-cost/low-external component count systems, where space is a premium.

The TPS51100 maintains fast transient response only requiring 20- μ F ($2 \times 10\mu$ F) of ceramic output capacitance. The TPS51100 supports remote sensing functions and all features required to power the DDR and DDR2 VTT bus termination according to the JEDEC specification. In addition, the TPS51100 includes integrated sleep-state controls placing VTT in High-Z in S3 (suspend to RAM) and soft-off for VTT and VTTREF in S5 (suspend to disk). The TPS51100 is available in the thermally efficient 10-pin MSOP PowerPAD™ and is specified from -40°C to 85°C .

ORDERING INFORMATION

T _A	PLASTIC MSOP POWER PAD (DGQ) ⁽¹⁾
-40°C to 85°C	TPS51100DGQ

⁽¹⁾ The DGQ package is also available taped and reeled. Add an R suffix to the device type (i.e., TPS51100DGQR). See the application section of the data sheet for PowerPAD drawing and layout information.

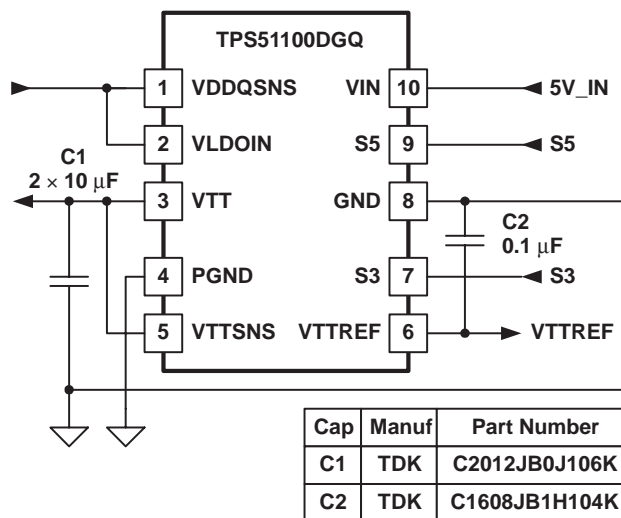

UDG-04015



These devices have limited built-in ESD protection. The leads should be shorted together or the device placed in conductive foam during storage or handling to prevent electrostatic damage to the MOS gates.

ABSOLUTE MAXIMUM RATINGS

over operating free-air temperature range unless otherwise noted⁽¹⁾

		TPS51100	UNIT
Input voltage range ⁽²⁾	VIN, VLDOIN, VTTSNS, VDDQSNS, S3, S5	-0.3 to 6	V
	PGND	-0.3 to 0.3	
Output voltage range ⁽²⁾	VTT, VTTREF	-0.3 to 6	
Operating ambient temperature range, TA		-40 to 85	°C
Storage temperature, Tstg		-55 to 150	

(1) Stresses beyond those listed under “absolute maximum ratings” may cause permanent damage to the device. These are stress ratings only, and functional operation of the device at these or any other conditions beyond those indicated under “recommended operating conditions” is not implied. Exposure to absolute-maximum-rated conditions for extended periods may affect device reliability.

(2) All voltage values are with respect to the network ground terminal unless otherwise noted.

DISSIPATION RATING TABLE

PACKAGE	TA < 25°C POWER RATING	DERATING FACTOR ABOVE TA = 25°C	TA = 85°C POWER RATING
10-pin DGQ	1.73 W	17.3 mW/°C	0.694 W

RECOMMENDED OPERATING CONDITIONS

		MIN	MAX	UNIT
Supply voltage, VIN		4.75	5.25	V
Voltage range	S3, S5	-0.10	5.25	
	VLDOIN, VDDQSNS, VTT, VTTSNS	-0.1	3.6	
	VTTREF	-0.1	1.8	
	PGND	-0.1	0.1	
Operating free-air temperature, TA		-40	85	°C

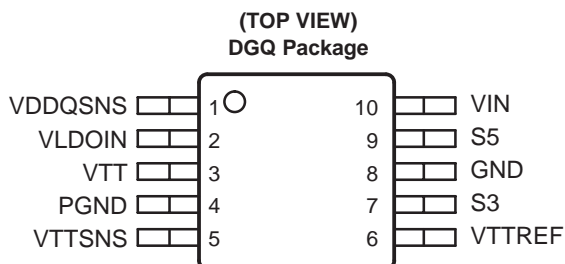

ACTUAL SIZE
3,05mm x 4,98mm

(4) For more information on the DGQ package, refer to TI Technical Brief, Literature No. SLMA002.

(5) PowerPAD™ heat slug must be connected to GND (pin 8) or electrically isolated from all other pins.

ELECTRICAL CHARACTERISTICS

$T_A = -40^\circ\text{C}$ to 85°C , $V_{VIN} = 5\text{ V}$, VLDOIN and VDDQSNS are connected to 2.5 V (unless otherwise noted)

PARAMETER		TEST CONDITIONS	MIN	TYP	MAX	UNIT		
SUPPLY CURRENT								
I_{VIN}	Supply current, VIN	$T_A = 25^\circ\text{C}$, $V_{S3} = V_{S5} = 5\text{ V}$	$V_{VIN} = 5\text{ V}$, no load	0.25	0.50	1.00	mA	
I_{VINSTB}	Standby current, VIN	$T_A = 25^\circ\text{C}$, $V_{S3} = 0\text{ V}$,	$V_{VIN} = 5\text{ V}$, $V_{S5} = 5\text{ V}$	no load	25	50	80	μA
$I_{VINSNDN}$	Shutdown current, VIN	$T_A = 25^\circ\text{C}$, $V_{S3} = V_{S5} = 0\text{ V}$,	$V_{VIN} = 5\text{ V}$, $V_{VLDOIN} = V_{VDDQSNS} = 0\text{ V}$	no load	0.3	1.0		
I_{VLDOIN}	Supply current, VLDOIN	$T_A = 25^\circ\text{C}$, $V_{S3} = V_{S5} = 5\text{ V}$	$V_{VIN} = 5\text{ V}$, no load	0.7	1.2	2.0	mA	
$I_{VLDOINSTB}$	Standby current, VLDOIN	$T_A = 25^\circ\text{C}$, $V_{S3} = 0\text{ V}$,	$V_{VIN} = 5\text{ V}$, $V_{S5} = 5\text{ V}$	no load	6	10	μA	
$I_{VLDOINSDN}$	Shutdown current, VLDOIN	$T_A = 25^\circ\text{C}$, $V_{S3} = V_{S5} = 0\text{ V}$	$V_{VIN} = 5\text{ V}$, no load	0.3	1.0			
INPUT CURRENT								
$I_{VDDQSNS}$	Input current, VDDQSNS	$V_{VIN} = 5\text{ V}$,	$V_{S3} = V_{S5} = 5\text{ V}$	1	3	5	μA	
I_{VTTSNS}	Input current, VTTSNS	$V_{VIN} = 5\text{ V}$,	$V_{S3} = V_{S5} = 5\text{ V}$	-1.00	-0.25	1.00		
VTT OUTPUT								
V_{VTTSNS}	Output voltage, VTT	$V_{VLDOIN} = V_{VDDQSNS} = 2.5\text{ V}$		1.25		V		
		$V_{VLDOIN} = V_{VDDQSNS} = 1.8\text{ V}$		0.9				
$V_{VTTTOL25}$	Output voltage tolerance to VTTREF, VTT	$V_{VLDOIN} = V_{VDDQSNS} = 2.5\text{ V}$ $ I_{VTT} = 0\text{ A}$		-20	20	mV		
		$V_{VLDOIN} = V_{VDDQSNS} = 2.5\text{ V}$ $ I_{VTT} = 1.5\text{ A}$		-30	30			
		$V_{VLDOIN} = V_{VDDQSNS} = 2.5\text{ V}$ $ I_{VTT} = 3\text{ A}$		-40	40			
$V_{VTTTOL18}$	Output voltage tolerance to VTTREF, VTT	$V_{VLDOIN} = V_{VDDQSNS} = 1.8\text{ V}$ $ I_{VTT} = 0\text{ A}$		-20	20			
		$V_{VLDOIN} = V_{VDDQSNS} = 1.8\text{ V}$ $ I_{VTT} = 1\text{ A}$		-30	30			
		$V_{VLDOIN} = V_{VDDQSNS} = 1.8\text{ V}$ $ I_{VTT} = 2\text{ A}$		-40	40			
$I_{VTTOCLSRC}$	Source current limit, VTT	$V_{TT} = \left(\frac{V_{VDDQSNS}}{2}\right) \times 0.95$, PGOOD = High		3.0	3.8	6.0	A	
		$V_{TT} = 0\text{ V}$		1.5	2.2	3.0		
$I_{VTTOCLSNK}$	Sink current limit, VTT	$V_{TT} = \left(\frac{V_{VDDQSNS}}{2}\right) \times 1.05$, PGOOD = High		3.0	3.6	6.0		
		$V_{VTT} = V_{VDDQ}$		1.5	2.2	3.0		
I_{VTTLK}	Leakage current, VTT	$V_{TT} = \left(\frac{V_{VDDQSNS}}{2}\right) = 1.25\text{ V}$, $T_A = 25^\circ\text{C}$		-1.0	0.5	1.0	μA	
		$V_{S3} = 0\text{ V}$, $V_{S5} = 5\text{ V}$						
$I_{VTTSNSLK}$	Leakage current, VTTSNS	$V_{TT} = \left(\frac{V_{VDDQSNS}}{2}\right) = 1.25\text{ V}$, $T_A = 25^\circ\text{C}$		-1.00	0.01	1.00		
I_{DSCHRG}	Discharge current, VTT	$T_A = 25^\circ\text{C}$, $V_{VDDQSNS} = 0\text{ V}$,	$V_{S3} = V_{S5} = 0\text{ V}$, $V_{VTT} = 0.5\text{ V}$	10	17	mA		

ELECTRICAL CHARACTERISTICS(continued)

T_A = -40°C to 85°C, V_{VIN} = 5 V, VLDOIN and VDDQSNS are connected to 2.5 V (unless otherwise noted)

PARAMETER		TEST CONDITIONS	MIN	TYP	MAX	UNIT
VTTREF OUTPUT						
V _{VTTREF}	Output voltage, VTTREF		$V_{VTTREF} = \left(\frac{V_{VDDQSNS}}{2} \right)$			V
V _{VTTREFTOL25}	Output voltage tolerance to VDDQSNS/2, VTTREF	V _{VLDOIN} = V _{VDDQSNS} = 2.5V, V _{VTTREF} < 10 mA	-20		20	mV
V _{VTTREFTOL18}	Output voltage tolerance to VDDQSNS/2, VTTREF	V _{VLDOIN} = V _{VDDQSNS} = 1.8V, V _{VTTREF} < 10 mA	-17		17	
I _{VTTREFOCL}	Source current limit, VTTREF	V _{VTTREF} = 0 V	10	20	30	mA
UVLO/LOGIC THRESHOLD						
V _{VINUV}	UVLO threshold voltage, VIN	Wake up	3.4	3.7	4.0	V
		Hysteresis	0.15	0.25	0.35	
V _{IH}	High-level input voltage	S3, S5	1.6			
V _{IL}	Low-level input voltage	S3, S5	0.3			
V _{IHYST}	Hysteresis voltage	S3, S5	0.2			
I _{ILEAK}	Logic input leakage current	S2, S5, T _A = 25°C	-1		1	
THERMAL SHUTDOWN						
T _{SDN}	Thermal shutdown threshold	Shutdown temperature	160			°C
		Hysteresis	10			

TERMINAL FUNCTIONS

TERMINAL NAME	NO.	I/O	DESCRIPTION
GND	8	-	Signal ground. Connect to negative terminal of the output capacitor
PGND	4	-	Power ground output for the VTT LDO
S3	7	I	S3 signal input
S5	9	I	S5 signal input
VDDQSNS	1	I	VDDQ sense input
VIN	10	I	5-V power supply
VLDOIN	2	I	Power supply for the VTT LDO and VTTREF output stage
VTT	3	O	Power output for the VTT LDO
VTTREF	6	O	VTT reference output. Connect to GND through 0.1-µF ceramic capacitor.
VTTSENS	5	I	Voltage sense input for the VTT LDO. Connect to plus terminal of the output capacitor.

SIMPLIFIED BLOCK DIAGRAM

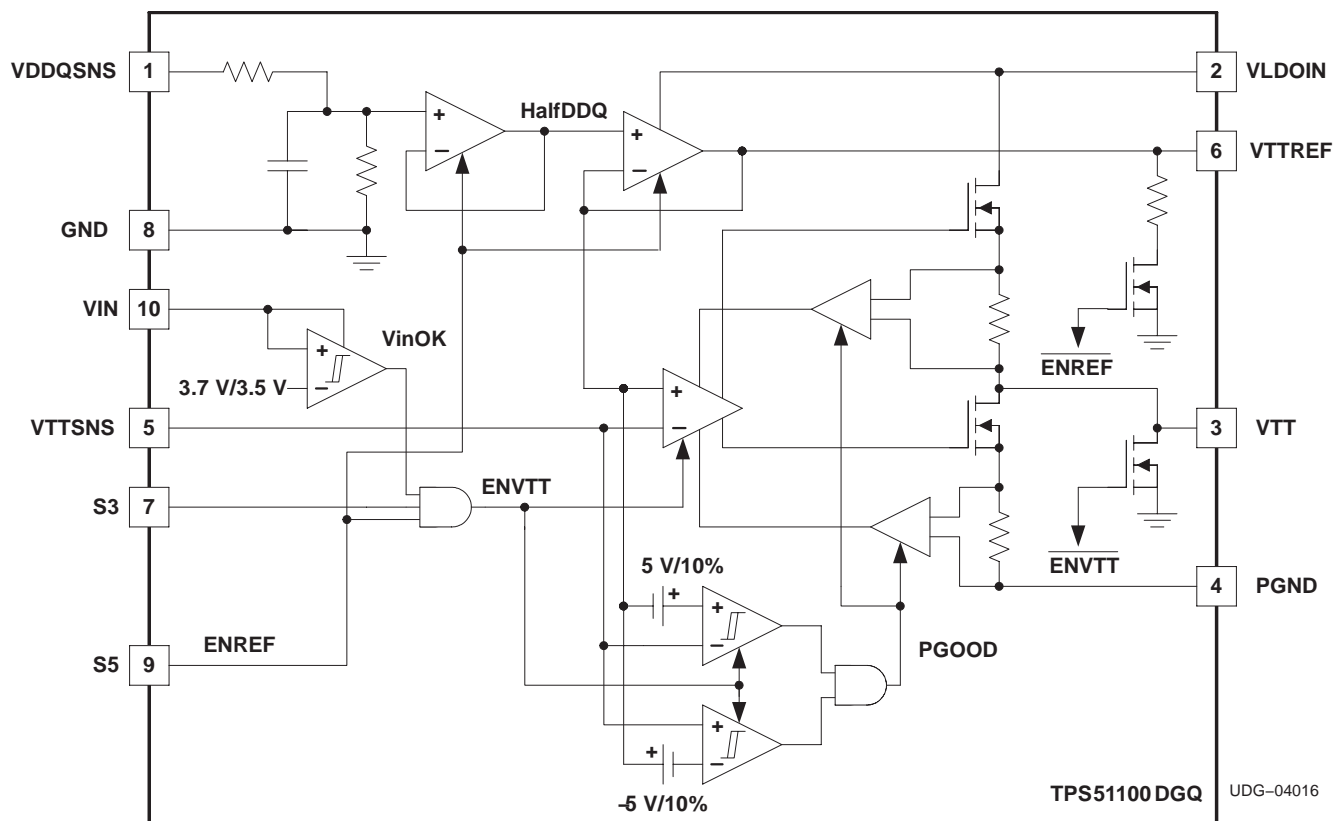

DETAILED DESCRIPTION

VTT SINK/SOURCE REGULATOR

The TPS51100 is a 3-A sink/source tracking termination regulator designed specially for low-cost, low external components system where space is at premium such as notebook PC applications. TPS51100 integrates high-performance low-dropout linear regulator that is capable of sourcing and sinking current up to 3 A. This VTT linear regulator employs ultimate fast response feedback loop so that small ceramic capacitors are enough to keep tracking to the VTTREF within ± 40 mV at all conditions including fast load transient. To achieve tight regulation with minimum effect of trace resistance, a remote sensing terminal, VTTSENS, should be connected to the positive node of VTT output capacitor(s) as a separate trace from the high current line from VTT.

VTTREF REGULATOR

The VTTREF block consists of an on-chip 1/2 divider, LPF and buffer. This regulator can source current up to 10 mA. Bypass VTTREF to GND using a 0.1- μ F ceramic capacitor to ensure stable operation.

Soft-Start

The soft-start function of the VTT is achieved via a current clamp, allowing the output capacitors to be charged with low and constant current that gives linear ramp up of the output voltage. The current limit threshold is changed in two stages using an internal powergood signal. When VTT is outside the powergood threshold, the current limit level is 2.2 A. When VTT rises above (VTTREF - 5%) or falls below (VTTREF + 5%) the current limit level switches to 3.8 A. The thresholds are typically VTTREF $\pm 5\%$ (from outside regulation to inside) and $\pm 10\%$ (when it falls outside). The soft-start function is completely symmetrical and it works not only from GND to VTTREF voltage, but also from VDDQ to VTTREF voltage. Note that the VTT output is in a high impedance state during the S3 state (S3 = low, S5 = high) and its voltage can be up to VDDQ voltage depending on the external condition. Note that VTT does not start under a full load condition.

S3, S5 Control and Soft-Off

The S3 and S5 terminals should be connected to SLP_S3 and SLP_S5 signals respectively. Both VTTREF and VTT are turned on at S0 state (S3 = high, S5 = high). VTTREF is kept alive while VTT is turned off and left high impedance in S3 state (S3 = low, S5 = high). Both VTT and VTTREF outputs are turned off and discharged to the ground through internal MOSFETs during S4/S5 state (both S3 and S5 are low).

Table 1. S3 and S5 Control Table

STATE	S3	S5	VTTREF	VTT
S0	H	H	1	1
S3	L	H	1	0 (high-Z)
S4/S5	L	L	0 (discharge)	0 (discharge)

(In case S3 is forced H and S5 to L, VTTREF is discharged and VTT is at High-Z state. This condition is NOT recommended.)

VTT Current Protection

The LDO has a constant overcurrent limit (OCL) at 3.8 A. This trip point is reduced to 2.2 A before the output voltage comes within $\pm 5\%$ of the target voltage or goes outside of $\pm 10\%$ of the target voltage.

DETAILED DESCRIPTION

VIN UVLO Protection

For VIN undervoltage lockout (UVLO) protection, the TPS51100 monitors VIN voltage. When the VIN voltage is lower than UVLO threshold voltage, the VTT regulator is shut off. This is a non-latch protection.

Thermal Shutdown

TPS51100 monitors its temperature. If the temperature exceeds threshold value, typically 160°C, the VTT and VTTREF regulators are shut off. This is also a non-latch protection.

Output Capacitor

For stable operation, total capacitance of the VTT output terminal can be equal or greater than 20-μF. Attach two 10-μF ceramic capacitors in parallel to minimize the effect of ESR and ESL. If the ESR is greater than 2 mΩ, insert an R-C filter between the output and the VTTSENS input to achieve loop stability. The R-C filter time constant should be almost the same or slightly lower than the time constant of the output capacitor and its ESR.

Soft-start duration, T_{SS} , is also a function of this output capacitance. Where $I_{TTOCL} = 2.2$ A (typ), T_{SS} can be calculated as,

$$T_{SS} = \left(\frac{C_{OUT} \times V_{VTT}}{I_{TTOCL}} \right) \quad (1)$$

Input Capacitor

Depending on the trace impedance between the VLDOIN bulk power supply to the part, transient increase of source current is supplied mostly by the charge from the VLDOIN input capacitor. Use a 10-μF (or more) ceramic capacitor to supply this transient charge. Provide more input capacitance as more output capacitance is used at VTT. In general, use 1/2 C_{OUT} for input.

VIN Capacitor

Add a ceramic capacitor with a value between 1.0-μF and 4.7-μF placed close to the VIN pin, to stabilize 5-V from any parasitic impedance from the supply.

Thermal design

As the TPS51100 is a linear regulator, the VTT current flow in both source and sink directions generate power dissipation from the device. In the source phase, the potential difference between V_{VLDOIN} and V_{VTT} times VTT current becomes the power dissipation, W_{DSRC} .

$$W_{DSRC} = (V_{VLDOIN} - V_{VTT}) \times I_{VTT} \quad (2)$$

In this case, if VLDOIN is connected to an alternative power supply lower than V_{DDQ} voltage, power loss can be decreased.

For the sink phase, VTT voltage is applied across the internal LDO regulator, and the power dissipation, and W_{DSNK} , is calculated by:

$$W_{DSNK} = V_{VTT} \times I_{VTT} \quad (3)$$

Since the device does not sink and source the current at the same time and I_{VTT} varies rapidly with time, actual power dissipation need to be considered for thermal design is an average of above value over thermal relaxation duration of the system. Another power consumption is the current used for internal control circuitry from VIN supply and VLDOIN supply. This can be estimated as 20 mW or less at normal operational conditions. This power needs to be effectively dissipated from the package. Maximum power dissipation allowed to the package is calculated by,

DETAILED DESCRIPTION

$$W_{\text{PKG}} = \frac{(T_{\text{J(max)}} - T_{\text{A(max)}})}{\theta_{\text{JA}}} \quad (4)$$

where

- $T_{\text{J(max)}}$ is 125°C
- $T_{\text{A(max)}}$ is the maximum ambient temperature in the system
- θ_{JA} is the thermal resistance from the silicon junction to the ambient

This thermal resistance strongly depends on the board layout. TPS51100 is assembled in a thermally enhanced PowerPAD™ package that has exposed die pad underneath the body. For improved thermal performance, this die pad needs to be attached to ground trace via thermal land on the PCB. This ground trace acts as a heat sink/spread. The typical thermal resistance, 57.7°C/W, is achieved based on a 3 mm × 2 mm thermal land with 2 vias without air flow. It can be improved by using larger thermal land and/or increasing vias number. For example, assuming 3 mm × 3 mm thermal land with 4 vias without air flow, it is 45.4°C/W. Further information about PowerPAD™ and its recommended board layout is described in the application note (SLMA002). This document is available at www.ti.com.

LAYOUT CONSIDERATIONS

Consider the following points before the layout of TPS51100 design begins.

- The input bypass capacitor for VLDOIN should be placed to the pin as close as possible with short and wide connection.
- The output capacitor for VTT should be placed close to the pin with short and wide connection in order to avoid additional ESR and/or ESL of the trace.
- VTTSNS should be connected to the positive node of VTT output capacitor(s) as a separate trace from the high current power line and is strongly recommended to avoid additional ESR and/or ESL. If it is needed to sense the voltage of the point of the load, it is recommended to attach the output capacitor(s) at that point. Also, it is recommended to minimize any additional ESR and/or ESL of ground trace between GND pin and the output capacitor(s).
- Consider adding LPF at VTTSNS in case ESR of the VTT output capacitor(s) is larger than 2 mΩ.
- VDDQSNS can be connected separately from VLDOIN. Remember that this sensing potential is the reference voltage of VTTREF. Avoid any noise generative lines.
- Negative node of VTT output capacitor(s) and VTTREF capacitor should be tied together by avoiding common impedance to the high current path of the VTT source/sink current.
- GND (Signal GND) pin node represents the reference potential for VTTREF and VTT outputs. Connect GND to negative nodes of VTT capacitor(s), VTTREF capacitor and VDDQ capacitor(s) with care to avoid additional ESR and/or ESL. GND and PGND (Power GND) should be isolated, with a single point connection between them.
- In order to effectively remove heat from the package, prepare thermal land and solder to the package's thermal pad. Wide trace of the component-side copper, connected to this thermal land, will help heat spreading. Numerous vias 0.33 mm in diameter connected from the thermal land to the internal/solder-side ground plane(s) should be used to help dissipation.

TYPICAL CHARACTERISTICS

VIN SUPPLY CURRENT
vs
TEMPERATURE

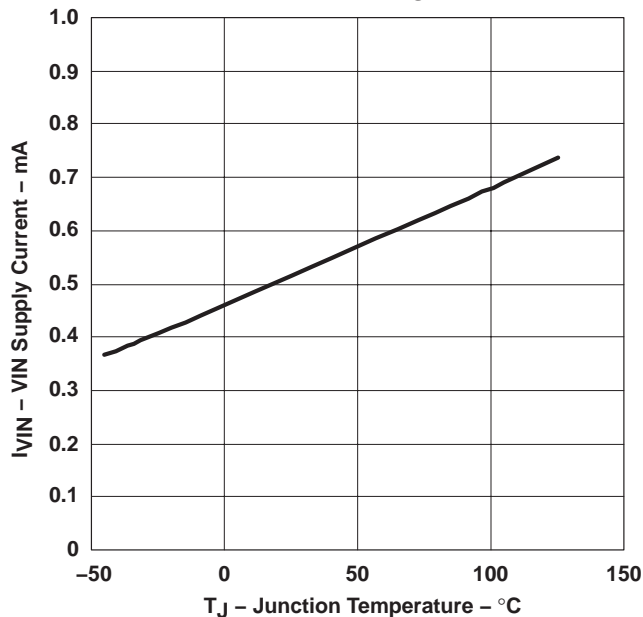

Figure 1

VIN SHUTDOWN CURRENT
vs
TEMPERATURE

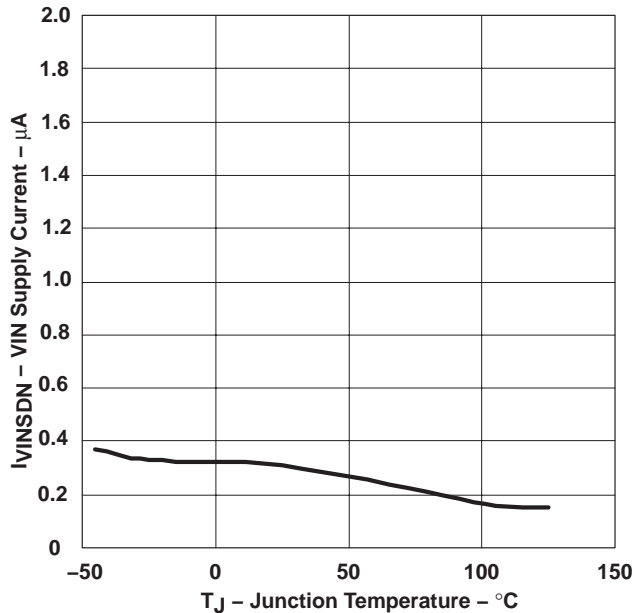

Figure 2

VIN SUPPLY CURRENT
vs
VTT LOAD CURRENT

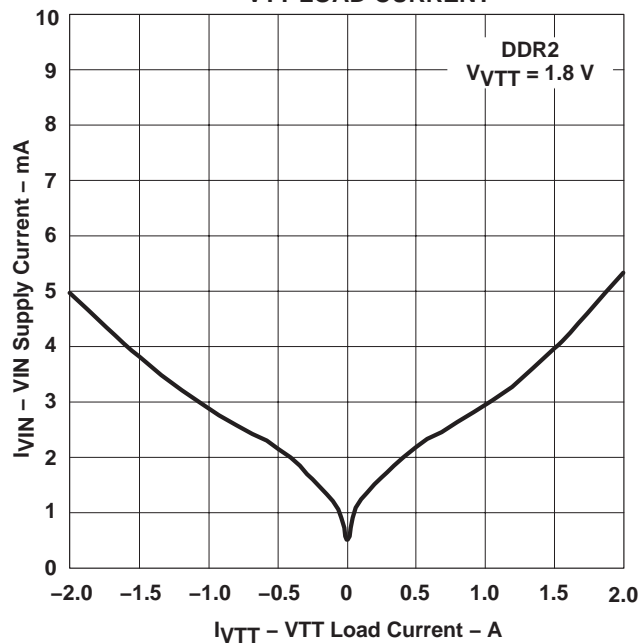

Figure 3

VLDOIN SUPPLY CURRENT
vs
TEMPERATURE

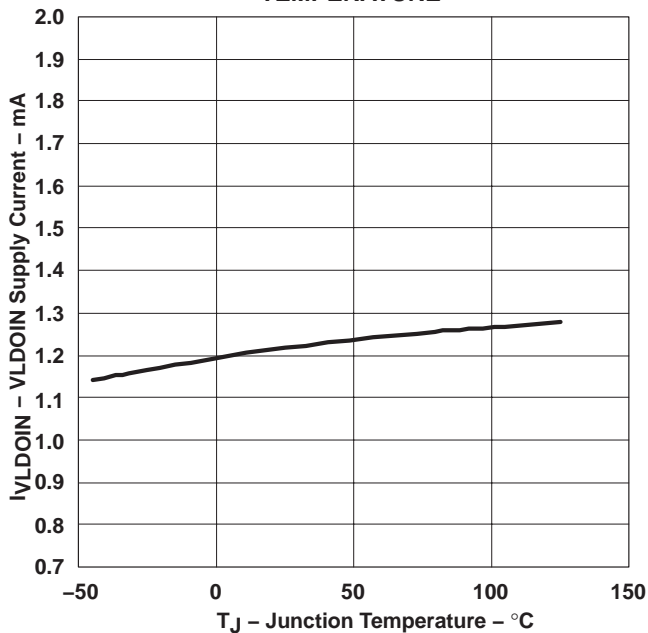

Figure 4

TYPICAL CHARACTERISTICS

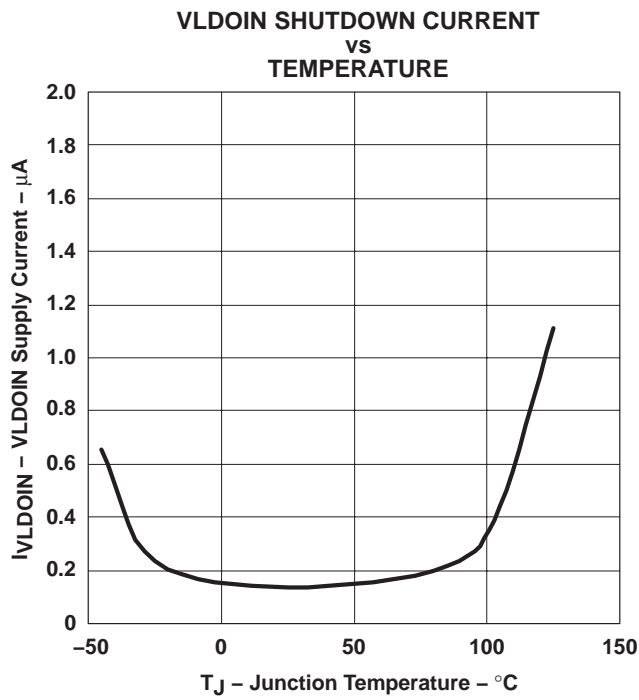

Figure 5

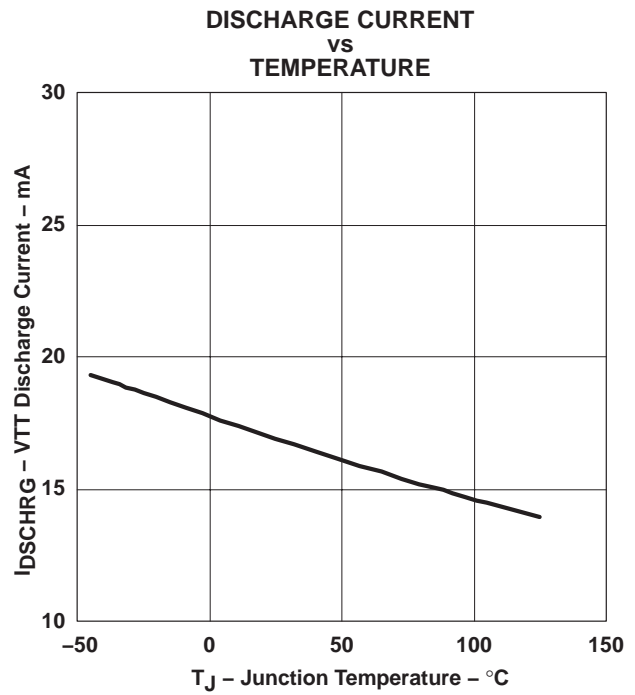

Figure 6

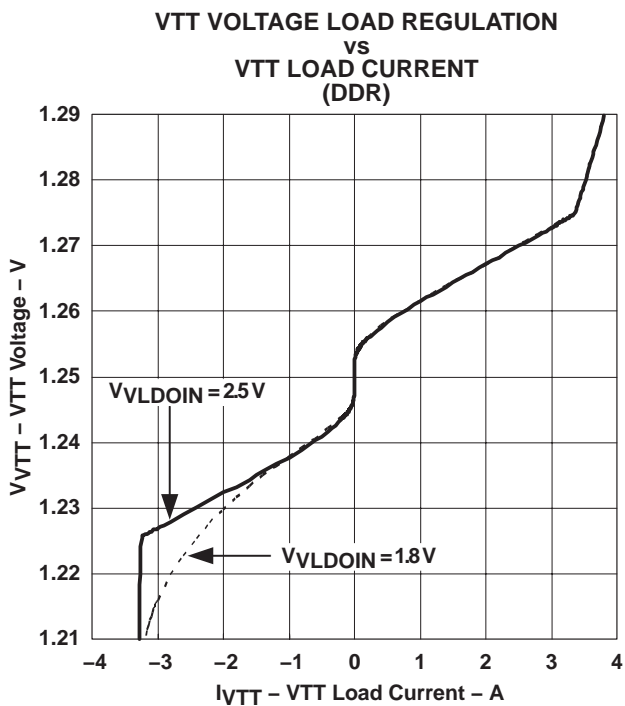

Figure 7

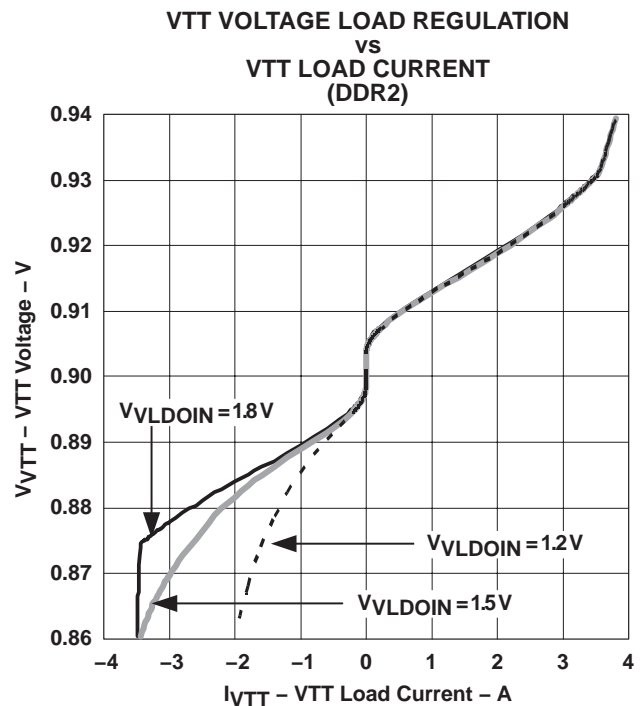

Figure 8

TYPICAL CHARACTERISTICS

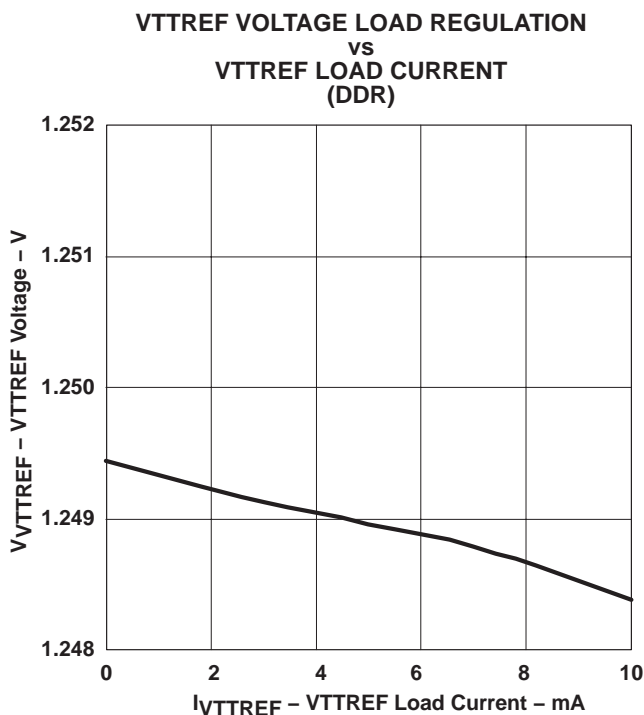

Figure 9

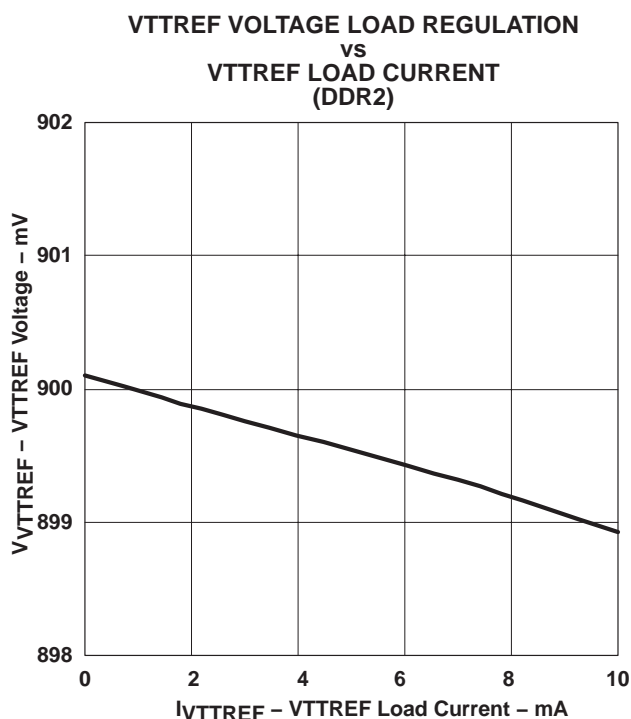

Figure 10

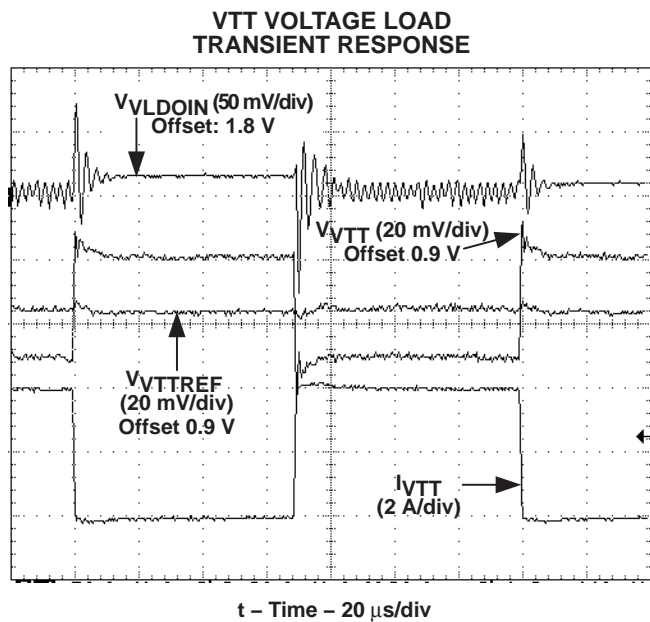
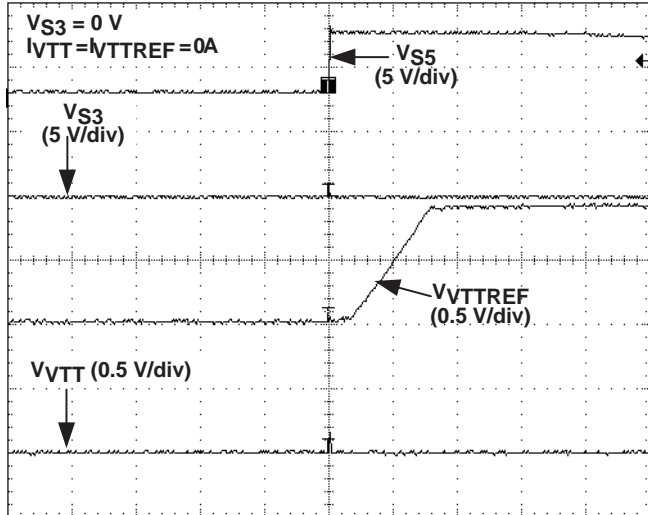

Figure 11

TYPICAL CHARACTERISTICS

STARTUP WAVEFORMS
S5 LOW-TO-HIGH



t – Time – 10 μ s/div
Figure 12

STARTUP WAVEFORMS
S3 LOW-TO-HIGH

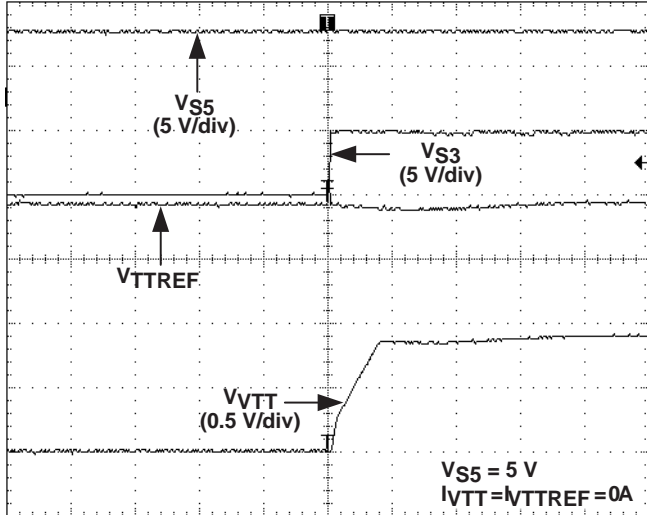

t – Time – 10 μ s/div
Figure 13

SHUTDOWN WAVEFORMS
S3 HIGH-TO-LOW

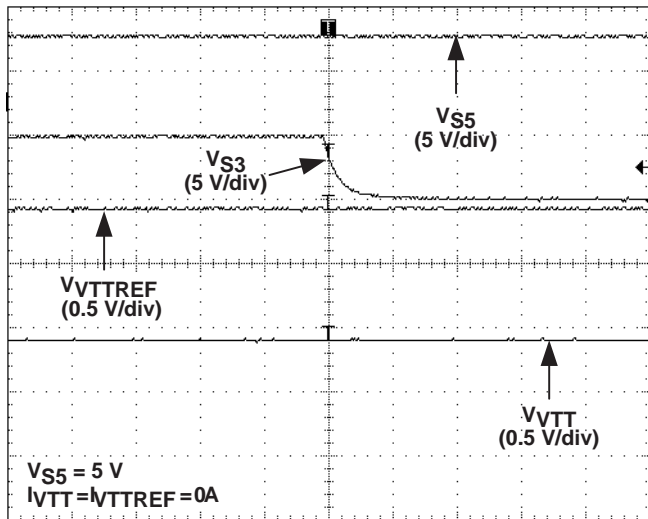

t – Time – 1 ms/div
Figure 14

SHUTDOWN WAVEFORMS
S3 AND S5 HIGH-TO-LOW

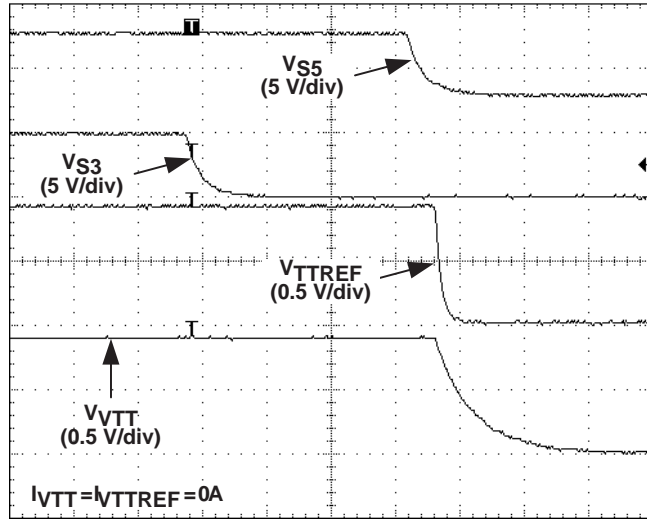

t – Time – 1 ms/div
Figure 15

TYPICAL CHARACTERISTICS

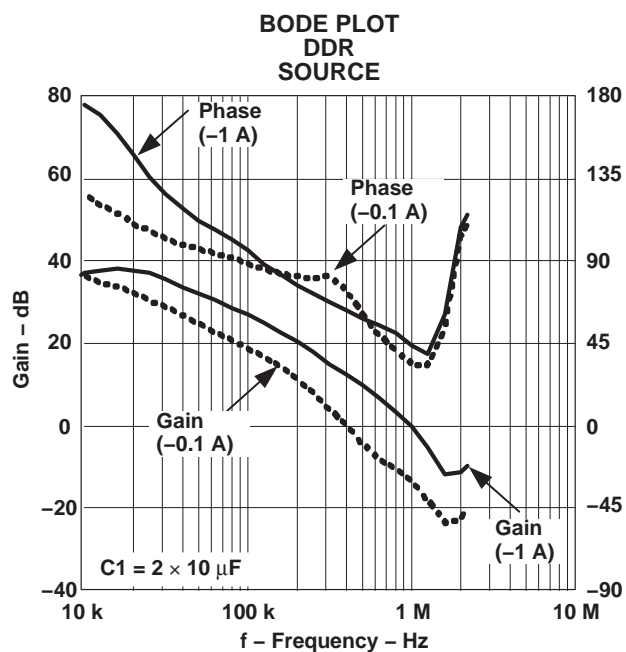

Figure 16

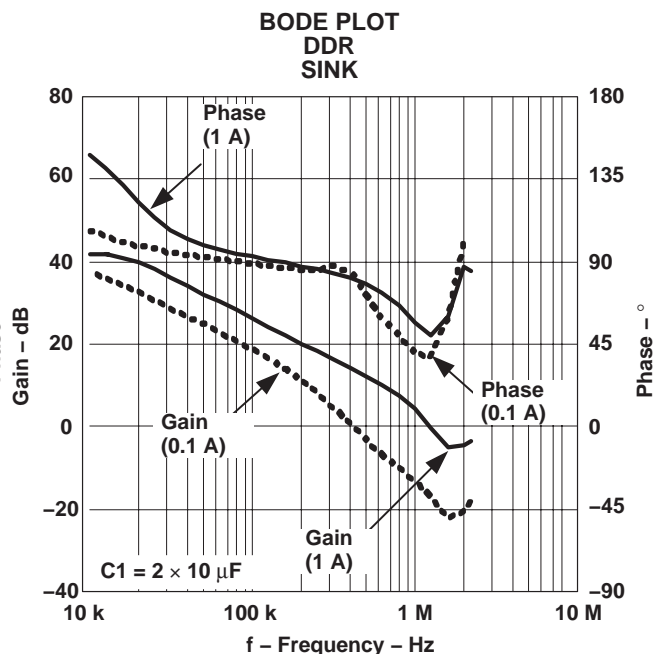

Figure 17

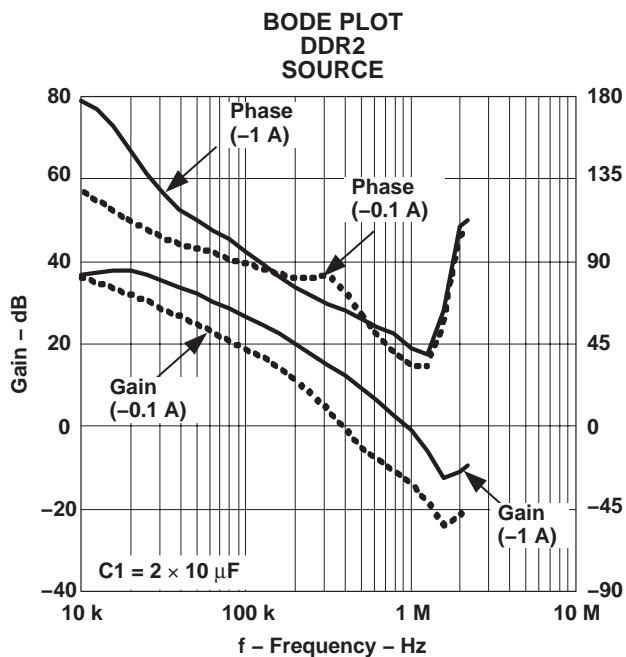

Figure 18

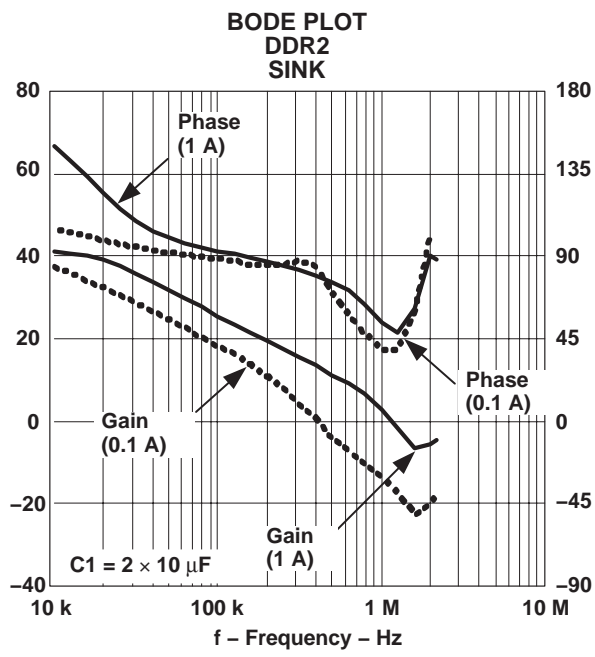

Figure 19

PACKAGING INFORMATION

Orderable Device	Status ⁽¹⁾	Package Type	Package Drawing	Pins	Package Qty	Eco Plan ⁽²⁾	Lead/Ball Finish	MSL Peak Temp ⁽³⁾
TPS51100DGQ	ACTIVE	MSOP-Power PAD	DGQ	10	80	Green (RoHS & no Sb/Br)	CU NIPDAU	Level-1-260C-UNLIM
TPS51100DGQG4	ACTIVE	MSOP-Power PAD	DGQ	10	80	Green (RoHS & no Sb/Br)	CU NIPDAU	Level-1-260C-UNLIM
TPS51100DGQR	ACTIVE	MSOP-Power PAD	DGQ	10	2500	Green (RoHS & no Sb/Br)	CU NIPDAU	Level-1-260C-UNLIM
TPS51100DGQRG4	ACTIVE	MSOP-Power PAD	DGQ	10	2500	Green (RoHS & no Sb/Br)	CU NIPDAU	Level-1-260C-UNLIM

⁽¹⁾ The marketing status values are defined as follows:

ACTIVE: Product device recommended for new designs.

LIFEBUY: TI has announced that the device will be discontinued, and a lifetime-buy period is in effect.

NRND: Not recommended for new designs. Device is in production to support existing customers, but TI does not recommend using this part in a new design.

PREVIEW: Device has been announced but is not in production. Samples may or may not be available.

OBsolete: TI has discontinued the production of the device.

⁽²⁾ Eco Plan - The planned eco-friendly classification: Pb-Free (RoHS), Pb-Free (RoHS Exempt), or Green (RoHS & no Sb/Br) - please check <http://www.ti.com/productcontent> for the latest availability information and additional product content details.

TBD: The Pb-Free/Green conversion plan has not been defined.

Pb-Free (RoHS): TI's terms "Lead-Free" or "Pb-Free" mean semiconductor products that are compatible with the current RoHS requirements for all 6 substances, including the requirement that lead not exceed 0.1% by weight in homogeneous materials. Where designed to be soldered at high temperatures, TI Pb-Free products are suitable for use in specified lead-free processes.

Pb-Free (RoHS Exempt): This component has a RoHS exemption for either 1) lead-based flip-chip solder bumps used between the die and package, or 2) lead-based die adhesive used between the die and leadframe. The component is otherwise considered Pb-Free (RoHS compatible) as defined above.

Green (RoHS & no Sb/Br): TI defines "Green" to mean Pb-Free (RoHS compatible), and free of Bromine (Br) and Antimony (Sb) based flame retardants (Br or Sb do not exceed 0.1% by weight in homogeneous material)

⁽³⁾ MSL, Peak Temp. -- The Moisture Sensitivity Level rating according to the JEDEC industry standard classifications, and peak solder temperature.

Important Information and Disclaimer:The information provided on this page represents TI's knowledge and belief as of the date that it is provided. TI bases its knowledge and belief on information provided by third parties, and makes no representation or warranty as to the accuracy of such information. Efforts are underway to better integrate information from third parties. TI has taken and continues to take reasonable steps to provide representative and accurate information but may not have conducted destructive testing or chemical analysis on incoming materials and chemicals. TI and TI suppliers consider certain information to be proprietary, and thus CAS numbers and other limited information may not be available for release.

In no event shall TI's liability arising out of such information exceed the total purchase price of the TI part(s) at issue in this document sold by TI to Customer on an annual basis.

TAPE AND REEL INFORMATION



QUADRANT ASSIGNMENTS FOR PIN 1 ORIENTATION IN TAPE

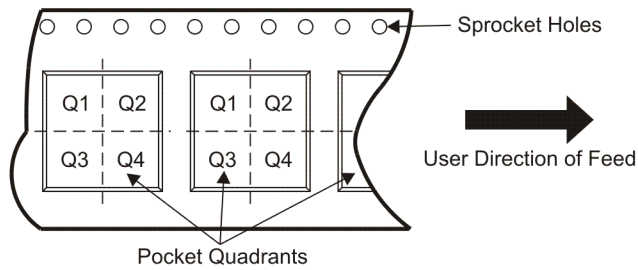

*All dimensions are nominal

Device	Package Type	Package Drawing	Pins	SPQ	Reel Diameter (mm)	Reel Width W1 (mm)	A0 (mm)	B0 (mm)	K0 (mm)	P1 (mm)	W (mm)	Pin1 Quadrant
TPS51100DGQR	MSOP-Power PAD	DGQ	10	2500	330.0	12.4	5.3	3.4	1.4	8.0	12.0	Q1

TAPE AND REEL BOX DIMENSIONS



*All dimensions are nominal

Device	Package Type	Package Drawing	Pins	SPQ	Length (mm)	Width (mm)	Height (mm)
TPS51100DGQR	MSOP-PowerPAD	DGQ	10	2500	346.0	346.0	29.0

DGQ (S-PDSO-G10)

PowerPAD™ PLASTIC SMALL-OUTLINE PACKAGE

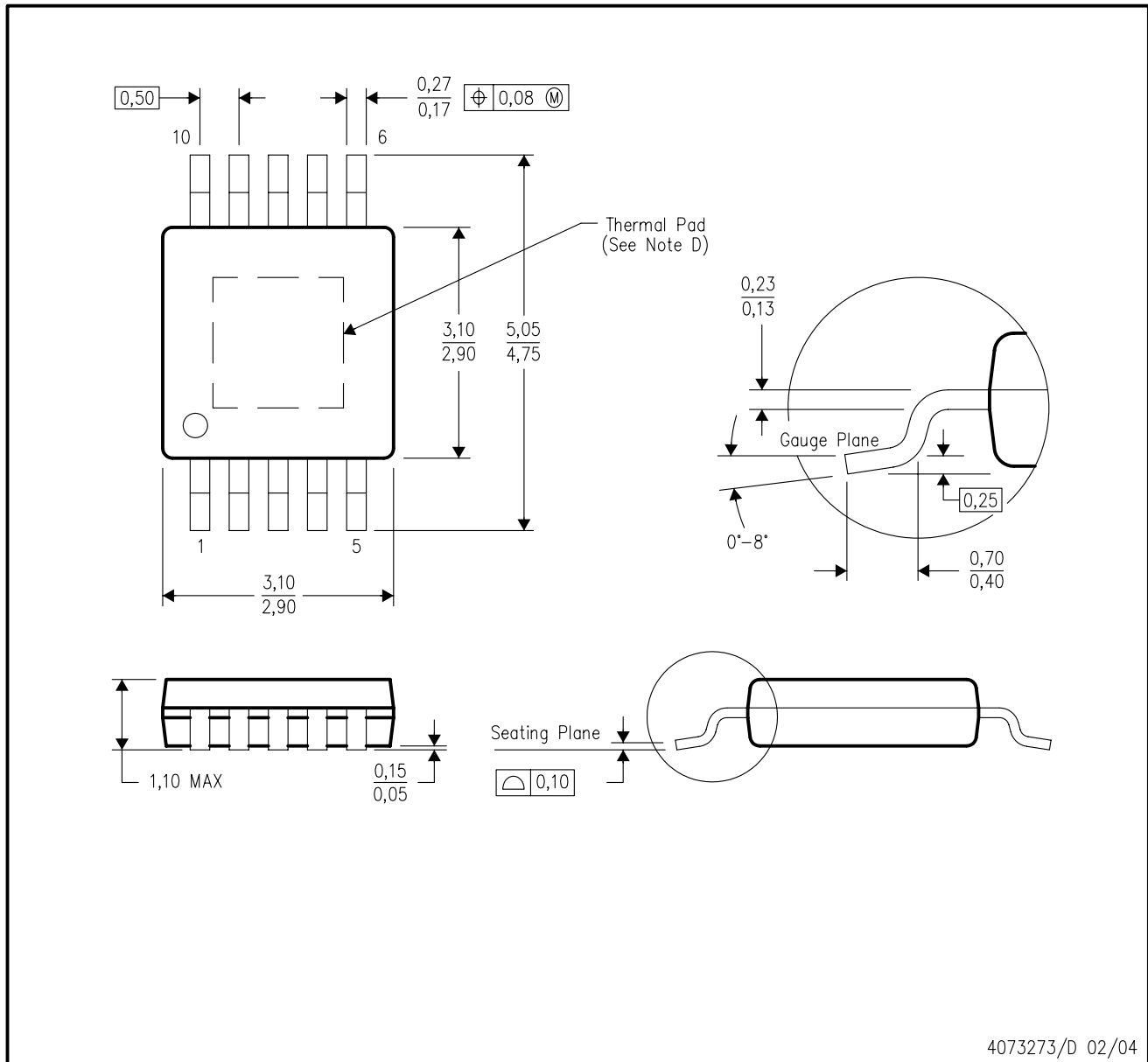

- NOTES:
- All linear dimensions are in millimeters.
 - This drawing is subject to change without notice.
 - Body dimensions do not include mold flash or protrusion.
 - This package is designed to be soldered to a thermal pad on the board. Refer to Technical Brief, PowerPAD Thermally Enhanced Package, Texas Instruments Literature No. SLMA002 for information regarding recommended board layout. This document is available at www.ti.com <<http://www.ti.com>>.
 - Falls within JEDEC MO-187 variation BA-T.

PowerPAD is a trademark of Texas Instruments.

THERMAL INFORMATION

This PowerPAD™ package incorporates an exposed thermal pad that is designed to be attached directly to an external heatsink. The thermal pad must be soldered directly to the printed circuit board (PCB). After soldering, the PCB can be used as a heatsink. In addition, through the use of thermal vias, the thermal pad can be attached directly to the appropriate copper plane shown in the electrical schematic for the device, or alternatively, can be attached to a special heatsink structure designed into the PCB. This design optimizes the heat transfer from the integrated circuit (IC).

For additional information on the PowerPAD package and how to take advantage of its heat dissipating abilities, refer to Technical Brief, PowerPAD Thermally Enhanced Package, Texas Instruments Literature No. SLMA002 and Application Brief, PowerPAD Made Easy, Texas Instruments Literature No. SLMA004. Both documents are available at www.ti.com.

The exposed thermal pad dimensions for this package are shown in the following illustration.

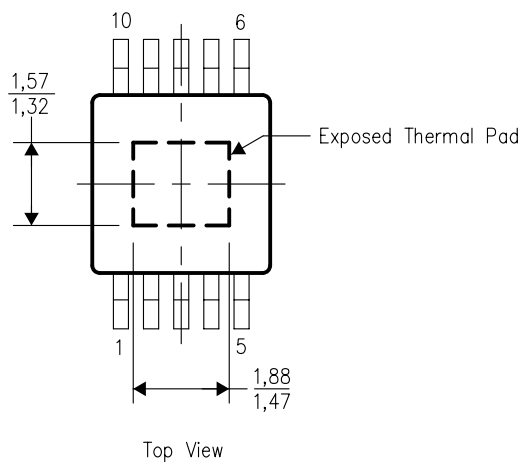

NOTE: All linear dimensions are in millimeters

Exposed Thermal Pad Dimensions

DGQ (R-PDSO-G10) PowerPAD™

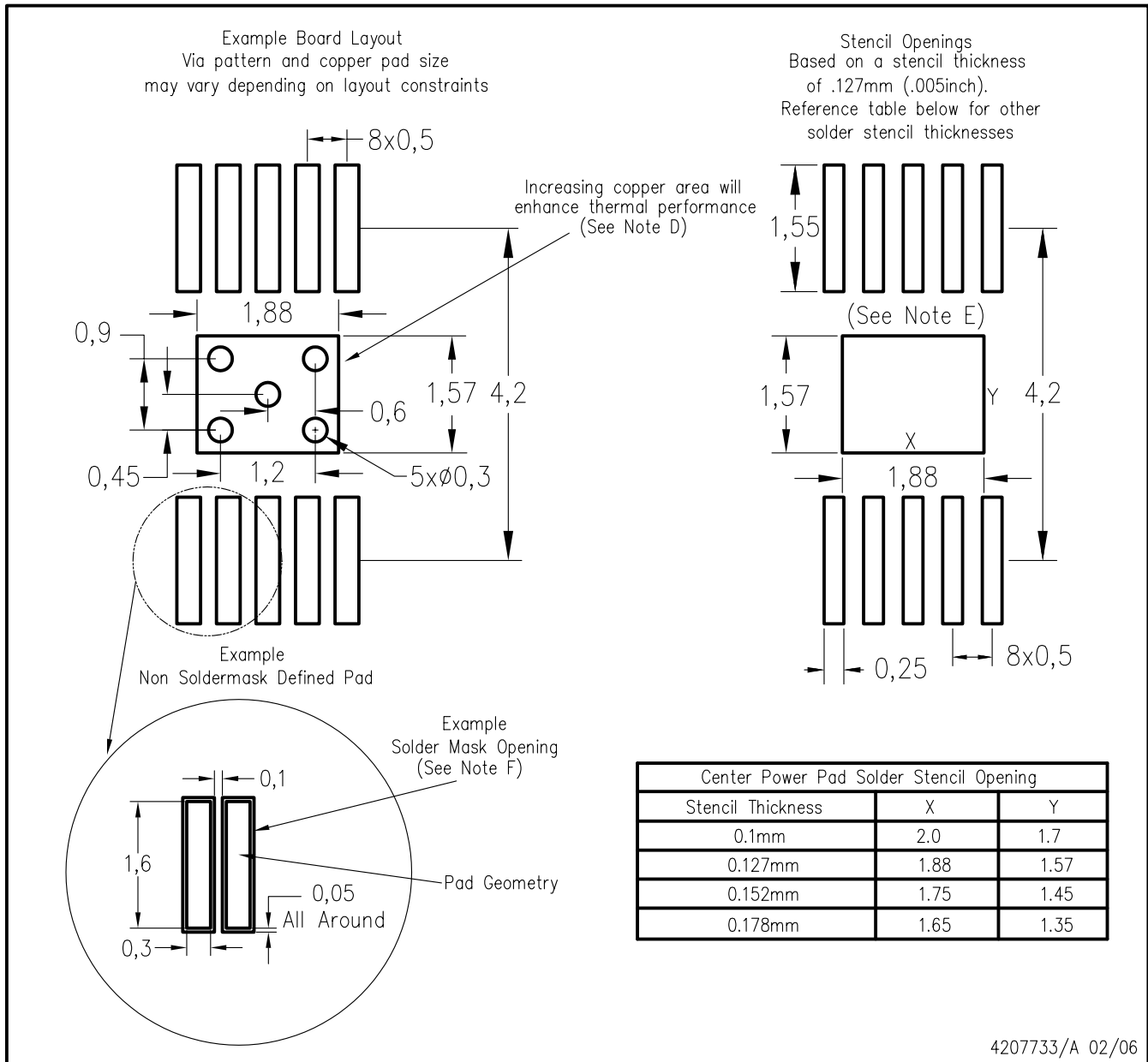

- NOTES:
- A. All linear dimensions are in millimeters.
 - B. This drawing is subject to change without notice.
 - C. Customers should place a note on the circuit board fabrication drawing not to alter the center solder mask defined pad.
 - D. This package is designed to be soldered to a thermal pad on the board. Refer to Technical Brief, PowerPad Thermally Enhanced Package, Texas Instruments Literature No. SLMA002, SLMA004, and also the Product Data Sheets for specific thermal information, via requirements, and recommended board layout. These documents are available at www.ti.com <<http://www.ti.com>>. Publication IPC-7351 is recommended for alternate designs.
 - E. Laser cutting apertures with trapezoidal walls and also rounding corners will offer better paste release. Customers should contact their board assembly site for stencil design recommendations. Example stencil design based on a 50% volumetric metal load solder paste. Refer to IPC-7525 for other stencil recommendations.
 - F. Customers should contact their board fabrication site for solder mask tolerances between and around signal pads.

IMPORTANT NOTICE

Texas Instruments Incorporated and its subsidiaries (TI) reserve the right to make corrections, modifications, enhancements, improvements, and other changes to its products and services at any time and to discontinue any product or service without notice. Customers should obtain the latest relevant information before placing orders and should verify that such information is current and complete. All products are sold subject to TI's terms and conditions of sale supplied at the time of order acknowledgment.

TI warrants performance of its hardware products to the specifications applicable at the time of sale in accordance with TI's standard warranty. Testing and other quality control techniques are used to the extent TI deems necessary to support this warranty. Except where mandated by government requirements, testing of all parameters of each product is not necessarily performed.

TI assumes no liability for applications assistance or customer product design. Customers are responsible for their products and applications using TI components. To minimize the risks associated with customer products and applications, customers should provide adequate design and operating safeguards.

TI does not warrant or represent that any license, either express or implied, is granted under any TI patent right, copyright, mask work right, or other TI intellectual property right relating to any combination, machine, or process in which TI products or services are used. Information published by TI regarding third-party products or services does not constitute a license from TI to use such products or services or a warranty or endorsement thereof. Use of such information may require a license from a third party under the patents or other intellectual property of the third party, or a license from TI under the patents or other intellectual property of TI.

Reproduction of TI information in TI data books or data sheets is permissible only if reproduction is without alteration and is accompanied by all associated warranties, conditions, limitations, and notices. Reproduction of this information with alteration is an unfair and deceptive business practice. TI is not responsible or liable for such altered documentation. Information of third parties may be subject to additional restrictions.

Resale of TI products or services with statements different from or beyond the parameters stated by TI for that product or service voids all express and any implied warranties for the associated TI product or service and is an unfair and deceptive business practice. TI is not responsible or liable for any such statements.

TI products are not authorized for use in safety-critical applications (such as life support) where a failure of the TI product would reasonably be expected to cause severe personal injury or death, unless officers of the parties have executed an agreement specifically governing such use. Buyers represent that they have all necessary expertise in the safety and regulatory ramifications of their applications, and acknowledge and agree that they are solely responsible for all legal, regulatory and safety-related requirements concerning their products and any use of TI products in such safety-critical applications, notwithstanding any applications-related information or support that may be provided by TI. Further, Buyers must fully indemnify TI and its representatives against any damages arising out of the use of TI products in such safety-critical applications.

TI products are neither designed nor intended for use in military/aerospace applications or environments unless the TI products are specifically designated by TI as military-grade or "enhanced plastic." Only products designated by TI as military-grade meet military specifications. Buyers acknowledge and agree that any such use of TI products which TI has not designated as military-grade is solely at the Buyer's risk, and that they are solely responsible for compliance with all legal and regulatory requirements in connection with such use.

TI products are neither designed nor intended for use in automotive applications or environments unless the specific TI products are designated by TI as compliant with ISO/TS 16949 requirements. Buyers acknowledge and agree that, if they use any non-designated products in automotive applications, TI will not be responsible for any failure to meet such requirements.

Following are URLs where you can obtain information on other Texas Instruments products and application solutions:

Products

Amplifiers	amplifier.ti.com
Data Converters	dataconverter.ti.com
DSP	dsp.ti.com
Clocks and Timers	www.ti.com/clocks
Interface	interface.ti.com
Logic	logic.ti.com
Power Mgmt	power.ti.com
Microcontrollers	microcontroller.ti.com
RFID	www.ti-rfid.com
RF/IF and ZigBee® Solutions	www.ti.com/lprf

Applications

Audio	www.ti.com/audio
Automotive	www.ti.com/automotive
Broadband	www.ti.com/broadband
Digital Control	www.ti.com/digitalcontrol
Medical	www.ti.com/medical
Military	www.ti.com/military
Optical Networking	www.ti.com/opticalnetwork
Security	www.ti.com/security
Telephony	www.ti.com/telephony
Video & Imaging	www.ti.com/video
Wireless	www.ti.com/wireless

Mailing Address: Texas Instruments, Post Office Box 655303, Dallas, Texas 75265
Copyright © 2008, Texas Instruments Incorporated