

TPS3606-33

BATTERY-BACKUP SUPERVISOR FOR LOW-POWER PROCESSORS

SLVS335C – DECEMBER 2000 – REVISED JANUARY 2007

features

- Supply Current of 40 μ A (Max)
- Precision 3.3-V Supply Voltage Monitor
Other Voltage Options on Request
- Watchdog Timer With 800-ms Time-Out
- Backup-Battery Voltage Can Exceed V_{DD}
- Power-On Reset Generator With Fixed 100-ms Reset Delay Time
- Voltage Monitor for Power-Fail or Low-Battery Monitoring
- Manual Switchover to Battery-Backup Mode
- Manual Reset
- Battery Freshness Seal
- 10-Pin MSOP Package
- Temperature Range . . . -40°C to 85°C

typical applications

- Fax Machines
- Set-Top Boxes
- Advanced Voice Mail Systems
- Portable Battery Powered Equipment
- Computer Equipment
- Advanced Modems
- Automotive Systems
- Portable Long-Time Monitoring Equipment
- Point-of-Sale Equipment

description

The TPS3606-33 supervisory circuit monitors and controls the processor activity. In case of power-fail or brownout conditions, the backup-battery switchover function of the TPS3606-33 allows a low-power processor and its peripherals to run from the installed backup battery without asserting a reset beforehand.

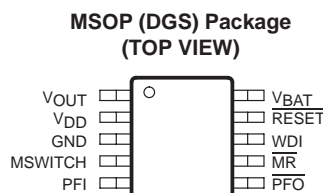

typical operating circuit

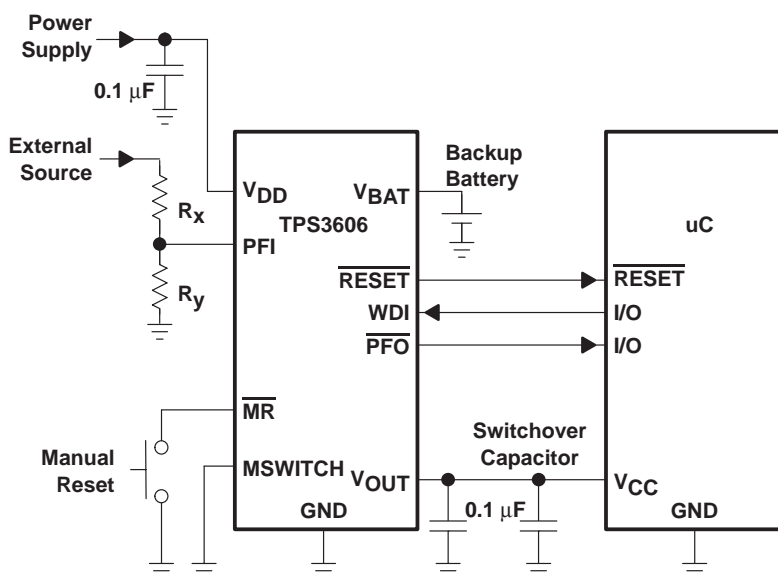

Please be aware that an important notice concerning availability, standard warranty, and use in critical applications of Texas Instruments semiconductor products and disclaimers thereto appears at the end of this data sheet.

All trademarks are the property of their respective owners.

PRODUCTION DATA information is current as of publication date. Products conform to specifications per the terms of Texas Instruments standard warranty. Production processing does not necessarily include testing of all parameters.

**TEXAS
INSTRUMENTS**
www.ti.com

Copyright © 2000–2007, Texas Instruments Incorporated

TPS3606-33 BATTERY-BACKUP SUPERVISOR FOR LOW-POWER PROCESSORS

SLVS335C – DECEMBER 2000 – REVISED JANUARY 2007

description (continued)

During power on, $\overline{\text{RESET}}$ is asserted when the supply voltage (V_{DD} or V_{BAT}) becomes higher than 1.1 V. Thereafter, the supply voltage supervisor monitors V_{OUT} and keeps the $\overline{\text{RESET}}$ output active as long as V_{OUT} remains below the threshold voltage (V_{IT}). An internal timer delays the return of the output to the inactive state (high) to ensure proper system reset. The delay time starts after V_{OUT} has risen above V_{IT} . When the supply voltage drops below V_{IT} , the output becomes active (low) again.

The TPS3606-33 is available in a 10-pin MSOP package and is characterized for operation over a temperature range of -40°C to 85°C .

PACKAGE INFORMATION

TA	DEVICE NAME	MARKING
-40°C to 85°C	TPS3606-33DGSR†	AKE

† The DGSR passive indicates tape and reel of 2500 parts.

ordering information application specific versions (see Note)

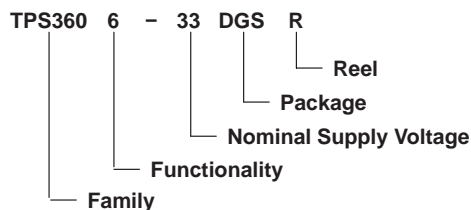

DEVICE NAME	NOMINAL VOLTAGE‡, V_{NOM}
TPS3606-33 DGS	3.3 V

‡ For other threshold voltages, contact the local TI sales office for availability and lead-time.

FUNCTION TABLES TPS3606

$V_{\text{DD}} > V_{\text{SW}}$	$V_{\text{OUT}} > V_{\text{IT}}$	$V_{\text{DD}} > V_{\text{BAT}}$	V_{OUT}	$\overline{\text{RESET}}$
0	0	0	V_{BAT}	0
0	0	1	V_{DD}	0
0	1	0	V_{BAT}	1
0	1	1	V_{DD}	1
1	1	0	V_{DD}	1
1	1	1	V_{DD}	1

$\text{PFI} > V_{\text{PFI}}$	$\overline{\text{PFO}}$
0	0
1	1

CONDITION.: $V_{\text{OUT}} > V_{\text{DD}}(\text{min})$

TPS3606-33 BATTERY-BACKUP SUPERVISOR FOR LOW-POWER PROCESSORS

SLVS335C – DECEMBER 2000 – REVISED JANUARY 2007

functional schematic

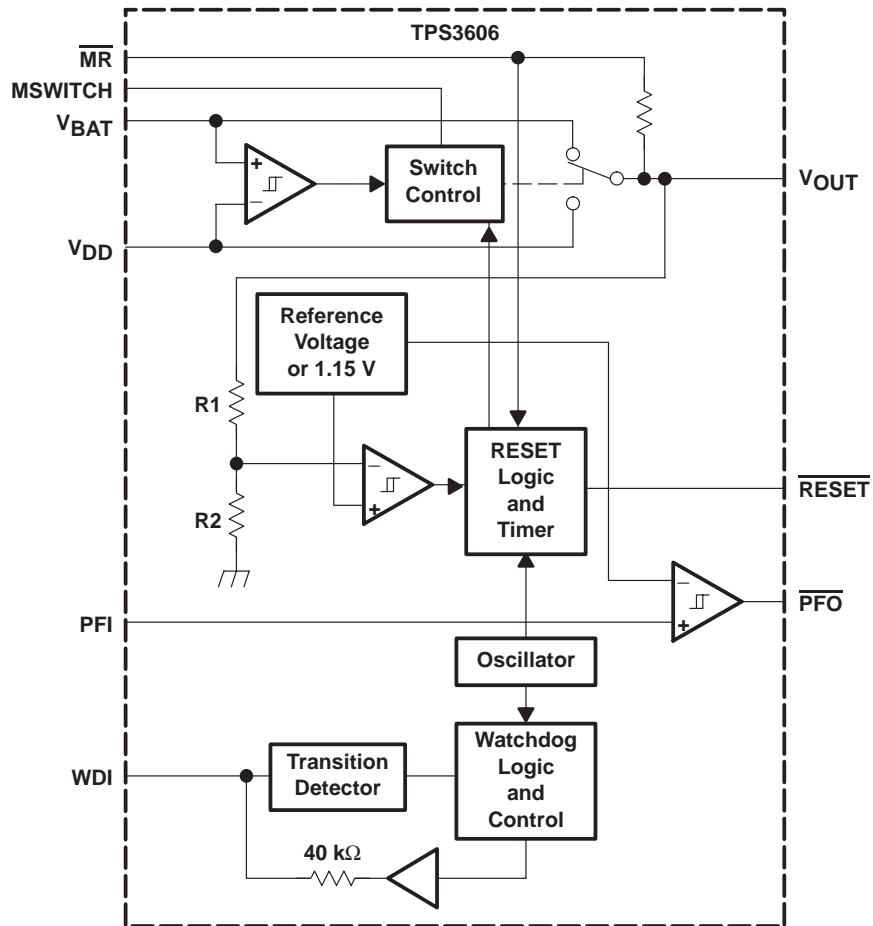

TPS3606-33 BATTERY-BACKUP SUPERVISOR FOR LOW-POWER PROCESSORS

SLVS335C – DECEMBER 2000 – REVISED JANUARY 2007

timing diagram

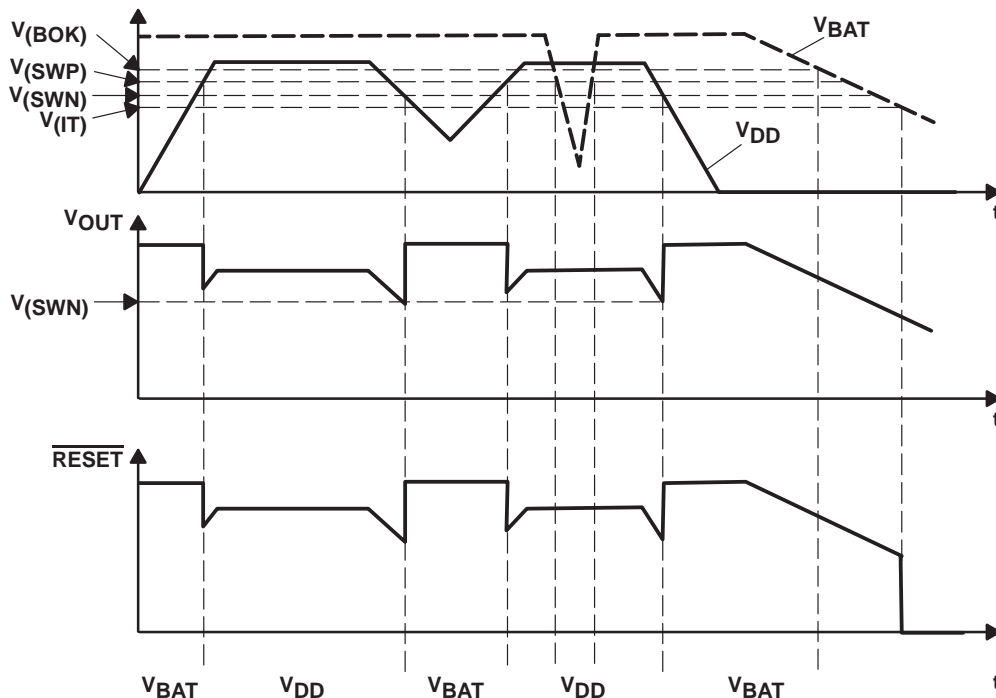

NOTES: A. $MSWITCH = 0$, $\overline{MR} = 1$

Terminal Functions

TERMINAL NAME	NO.	I/O	DESCRIPTION
GND	3	I	Ground
\overline{MR}	7	I	Manual reset input
MSWITCH	4	I	Manual switch to force device into battery-backup mode
PFI	5	I	Power-fail comparator input
\overline{PFO}	6	O	Power-fail comparator output
\overline{RESET}	9	O	Active-low reset output
V _{BAT}	10	I	Backup-battery input
V _{DD}	2	I	Input supply voltage
V _{OUT}	1	O	Supply output
WDI	8	I	Watchdog timer input

detailed description

battery freshness seal

The battery freshness seal of the TPS3606 family disconnects the backup battery from the internal circuitry until it is needed. This ensures that the backup battery connected to V_{BAT} is fresh when the final product is put to use. The following steps explain how to enable the freshness seal mode:

1. Connect V_{BAT} ($V_{BAT} > V_{BAT(min)}$)
2. Ground \overline{PFO}
3. Connect PFI to V_{DD} or $PFI > V_{(PFI)}$
4. Connect V_{DD} to power supply ($V_{DD} > V_{IT}$)
5. Ground \overline{MR}
6. Power down V_{DD}
7. The freshness seal mode is entered and pins \overline{PFO} and \overline{MR} can be disconnected.

The battery freshness seal mode is disabled by the positive-going edge of \overline{RESET} when V_{DD} is applied.

power-fail comparator (PFI and \overline{PFO})

An additional comparator is provided to monitor voltages other than the nominal supply voltage. The power-fail input (PFI) is compared with an internal voltage reference of 1.15 V. If the input voltage falls below the power-fail threshold ($V_{(PFI)}$) of 1.15 V typical, the power-fail output (\overline{PFO}) goes low. If it goes above $V_{(PFI)}$ plus about 12-mV hysteresis, the output returns to high. By connecting two external resistors, it is possible to supervise any voltages above $V_{(PFI)}$. The sum of both resistors should be about 1 M Ω , to minimize power consumption and also to ensure that the current in the PFI pin can be neglected compared with the current through the resistor network. The tolerance of the external resistors should be not more than 1% to ensure minimal variation of sensed voltage.

If the power-fail comparator is unused, connect PFI to ground and leave \overline{PFO} unconnected.

backup-battery switchover

In the event of a brownout or power failure, it may be necessary to keep a processor running. If a backup battery is installed at V_{BAT} , the devices automatically connect the processor to backup power when V_{DD} fails. In order to allow the backup battery (e.g., a 3.6-V lithium cell) to have a higher voltage than V_{DD} , this family of supervisors does not connect V_{BAT} to V_{OUT} when V_{BAT} is greater than V_{DD} . V_{BAT} only connects to V_{OUT} (through a 2- Ω switch) when V_{OUT} falls below $V_{(SWN)}$ and V_{BAT} is greater than V_{DD} . When V_{DD} recovers, switchover is deferred either until V_{DD} crosses V_{BAT} , or when V_{DD} rises above the threshold ($V_{(SWP)}$).

$V_{DD} > V_{BAT}$	$V_{DD} > V_{(SWN)}$	V_{OUT}
1	1	V_{DD}
1	0	V_{DD}
0	1	V_{DD}
0	0	V_{BAT}

TPS3606-33 BATTERY-BACKUP SUPERVISOR FOR LOW-POWER PROCESSORS

SLVS335C – DECEMBER 2000 – REVISED JANUARY 2007

detailed description (continued)

manual switchover (MSWITCH)

While operating in the normal mode from V_{DD} , the device can be manually forced to operate in the battery-backup mode by connecting MSWITCH to V_{DD} . The table below shows the different switchover modes.

	MSWITCH	Status
V_{DD} mode	GND	V_{DD} mode
	V_{DD}	Switch to battery-backup mode
Battery-backup mode	GND	Battery-backup mode
	V_{DD}	Battery-backup mode

If the manual switchover feature is not used, MSWITCH must be connected to ground.

watchdog

In a microprocessor- or DSP-based system, it is not only important to supervise the supply voltage, it is also important to ensure the correct program execution. The task of a watchdog is to ensure that the program is not stalled in an indefinite loop. The microprocessor, microcontroller, or the DSP has to toggle the watchdog input within typically 0.8 s to avoid a time-out from occurring. Either a low-to-high or a high-to-low transition resets the internal watchdog timer. If the input is unconnected, the watchdog is disabled and is retriggered internally.

saving current while using the watchdog

The watchdog input is internally driven low during the first 7/8 of the watchdog time-out period, then momentarily pulses high, resetting the watchdog counter. For minimum watchdog input current (minimum overall power consumption), leave WDI low for the majority of the watchdog time-out period, pulsing it low-high-low once within 7/8 of the watchdog time-out period to reset the watchdog timer. If instead, WDI is externally driven high for the majority of the time-out period, a current of e.g. $5\text{ V}/40\text{ k}\Omega \approx 125\text{ }\mu\text{A}$ can flow into WDI.

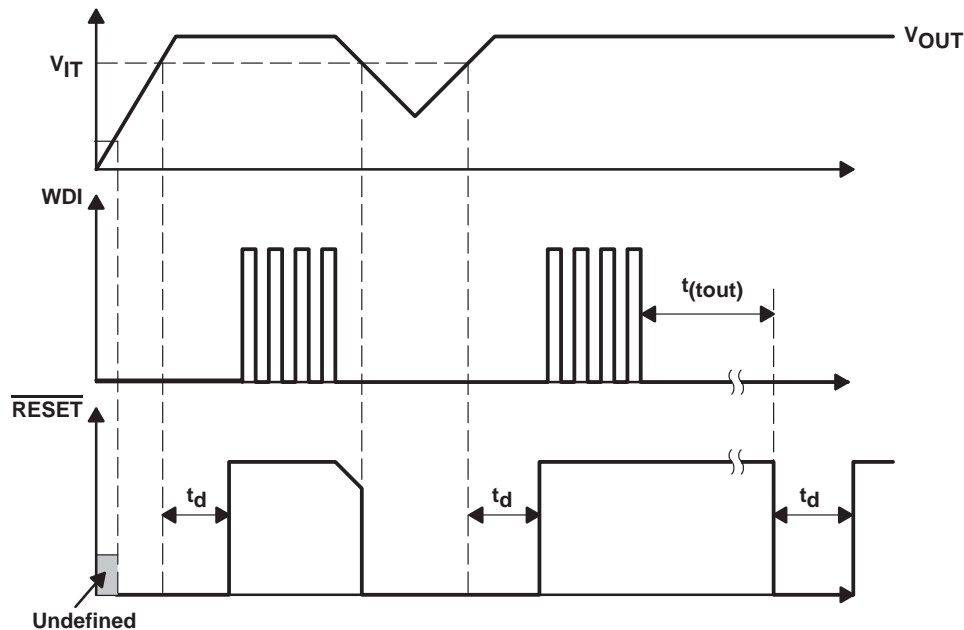

Figure 1. Watchdog Timing

TPS3606-33

BATTERY-BACKUP SUPERVISOR FOR LOW-POWER PROCESSORS

SLVS335C – DECEMBER 2000 – REVISED JANUARY 2007

absolute maximum ratings over operating free-air temperature (unless otherwise noted)†

Supply voltage: V_{DD} (see Note1)	7 V
\overline{MR} , WDI, and PFI pins (see Note 1)	–0.3 V to ($V_{DD} + 0.3$ V)
Continuous output current at V_{OUT} : I_O	300 mA
All other pins, I_O	±10 mA
Continuous total power dissipation	See Dissipation Rating Table
Operating free-air temperature range, T_A	–40°C to 85°C
Storage temperature range, T_{stg}	–65°C to 150°C
Lead temperature soldering 1,6 mm (1/16 inch) from case for 10 seconds	260°C

† Stresses beyond those listed under “absolute maximum ratings” may cause permanent damage to the device. These are stress ratings only, and functional operation of the device at these or any other conditions beyond those indicated under “recommended operating conditions” is not implied. Exposure to absolute-maximum-rated conditions for extended periods may affect device reliability.

NOTE 1: All voltage values are with respect to GND. For reliable operation the device must not be operated at 7 V for more than $t = 1000h$ continuously.

DISSIPATION RATING TABLE

PACKAGE	$T_A < 25^\circ\text{C}$ POWER RATING	DERATING FACTOR ABOVE $T_A = 25^\circ\text{C}$	$T_A = 70^\circ\text{C}$ POWER RATING	$T_A = 85^\circ\text{C}$ POWER RATING
DGS	424 mW	3.4 mW/°C	271 mW	220 mW

recommended operating conditions at specified temperature range

	MIN	MAX	UNIT
Supply voltage, V_{DD}	1.65	5.5	V
Battery supply voltage, V_{BAT}	1.5	5.5	V
Input voltage, V_I	0	$V_O + 0.3$	V
High-level input voltage, V_{IH}	$0.7 \times V_O$		V
Low-level input voltage, all other pins, V_{IL}		$0.3 \times V_O$	V
Continuous output current at V_{OUT} : I_O		200	mA
Input transition rise and fall rate at WDI, MSWITCH, $\Delta t/\Delta V$		100	ns/V
Slew rate at V_{DD} or V_{BAT}		34	mV/ μs
Operating free-air temperature range, T_A	–40	85	°C

TPS3606-33

BATTERY-BACKUP SUPERVISOR FOR LOW-POWER PROCESSORS

SLVS335C – DECEMBER 2000 – REVISED JANUARY 2007

electrical characteristics over recommended operating conditions (unless otherwise noted)

PARAMETER		TEST CONDITIONS	MIN	TYP	MAX	UNIT
V _{OH}	High-level output voltage	$\overline{\text{RESET}}$ V _{OUT} = 2 V, I _{OH} = -400 μA	V _{OUT} - 0.2 V			V
			V _{OUT} = 3.3 V, I _{OH} = -2 mA V _{OUT} = 5 V, I _{OH} = -3 mA	V _{OUT} - 0.4 V		
		$\overline{\text{PFO}}$ V _{OUT} = 1.8 V, I _{OH} = -20 μA	V _{OUT} - 0.3 V			
			V _{OUT} = 3.3 V, I _{OH} = -80 μA V _{OUT} = 5 V, I _{OH} = -120 μA	V _{OUT} - 0.4 V		
V _{OL}	Low-level output voltage	$\overline{\text{RESET}}$ V _{OUT} = 2 V, I _{OL} = 400 μA	0.2			V
		$\overline{\text{PFO}}$ V _{OUT} = 3.3 V, I _{OL} = 2 mA V _{OUT} = 5 V, I _{OL} = 3 mA	0.4			
		V _{res}	Power-up reset voltage (see Note 2)	V _{BAT} > 1.1 V or V _{DD} > 1.4 V, I _{OL} = 20 μA	0.4	
V _{OUT}	Normal mode	I _O = 5 mA, V _{DD} = 1.8 V	V _{DD} - 50 mV			V
		I _O = 75 mA, V _{DD} = 3.3 V	V _{DD} - 150 mV			
		I _O = 150 mA, V _{DD} = 5 V	V _{DD} - 250 mV			
	Battery-backup mode	I _O = 4 mA, V _{BAT} = 1.5 V	V _{BAT} - 50 mV			
		I _O = 75 mA, V _{BAT} = 3.3 V	V _{BAT} - 150 mV			
r _{ds(on)}	V _{DD} to V _{OUT} on-resistance	V _{DD} = 3.3 V	1 2			Ω
	V _{BAT} to V _{OUT} on-resistance	V _{BAT} = 3.3 V	1 2			
V _{IT}	Negative-going input threshold voltage (see Notes 3 and 4)	TPS3606x33	2.87	2.93	2.99	V
V _(PFI)	Power-fail input threshold voltage	PFI	1.13	1.15	1.17	
V _(SWN)	Battery switch threshold voltage negative-going V _{OUT}		V _{IT} + 1%	V _{IT} + 2%	V _{IT} + 3.2%	V

- NOTES:
- The lowest supply voltage at which $\overline{\text{RESET}}$ becomes active. $t_r(\text{VDD}) \geq 15 \mu\text{s/V}$.
 - To ensure best stability of the threshold voltage, a bypass capacitor (ceramic, 0.1 μF) should be placed near the supply terminal.
 - Voltage is sensed at V_{OUT}
 - For details on how to optimize current consumption when using WDI refer to section detailed description.

TPS3606-33
BATTERY-BACKUP SUPERVISOR FOR LOW-POWER PROCESSORS

SLVS335C – DECEMBER 2000 – REVISED JANUARY 2007

electrical characteristics over recommended operating conditions (unless otherwise noted)
(continued)

PARAMETER		TEST CONDITIONS	MIN	TYP	MAX	UNIT	
V_{hys}	Hysteresis	V_{IT}	$1.65\text{ V} < V_{IT} < 2.5\text{ V}$		20	mV	
			$2.5\text{ V} < V_{IT} < 3.5\text{ V}$		40		
			$3.5\text{ V} < V_{IT} < 5.5\text{ V}$		50		
	V_{PFI}			12			
	$V_{(SWN)}$	$1.65\text{ V} < V_{(SWN)} < 2.5\text{ V}$		85			
		$2.5\text{ V} < V_{(SWN)} < 3.5\text{ V}$		100			
$3.5\text{ V} < V_{(SWN)} < 5.5\text{ V}$		110					
I_{IH}	High-level input current	\overline{WDI}	$\overline{WDI} = V_{DD} = 5.5\text{ V}$		150	μA	
		\overline{MR}	$\overline{MR} = 0.7 \times V_{DD}, V_{DD} = 5\text{ V}$		-33	-76	
I_{IL}	Low-level input current	\overline{WDI}	$\overline{WDI} = 0\text{ V}, V_{DD} = 5\text{ V}$		-150		
		\overline{MR}	$\overline{MR} = 0\text{ V}, V_{DD} = 5\text{ V}$		-110	-255	
I_I	Input current	PFI, MSWITCH	$V_I < V_{DD}$		-25	25	nA
I_{OS}	Short-circuit current	\overline{PFO}	$\overline{PFO} = 0\text{ V}, V_{DD} = 1.8\text{ V}$		-0.3	mA	
			$\overline{PFO} = 0\text{ V}, V_{DD} = 3.3\text{ V}$		-1.1		
			$\overline{PFO} = 0\text{ V}, V_{DD} = 5\text{ V}$		-2.4		
I_{DD}	V_{DD} supply current	$V_{OUT} = V_{DD}$		40		μA	
		$V_{OUT} = V_{BAT}$		8			
$I_{(BAT)}$	V_{BAT} supply current	$V_{OUT} = V_{DD}$		-0.1	0.1	μA	
		$V_{OUT} = V_{BAT}$		40			
C_i	Input capacitance	$V_I = 0\text{ V to } 5\text{ V}$		5		pF	

timing requirements at $R_L = 1\text{ M}\Omega$, $C_L = 50\text{ pF}$, $T_A = -40^\circ\text{C to } 85^\circ\text{C}$

PARAMETER		TEST CONDITIONS	MIN	TYP	MAX	UNIT
t_w	Pulse width	V_{DD}	$V_{IH} = V_{IT} + 0.2\text{ V}, V_{IL} = V_{IT} - 0.2\text{ V}$		5	μs
		\overline{MR}	$V_{DD} > V_{IT} + 0.2\text{ V}, V_{IL} = 0.3 \times V_{DD}, V_{IH} = 0.7 \times V_{DD}$		100	
		\overline{WDI}				

switching characteristics at $R_L = 1\text{ M}\Omega$, $C_L = 50\text{ pF}$, $T_A = -40^\circ\text{C to } 85^\circ\text{C}$

PARAMETER		TEST CONDITIONS	MIN	TYP	MAX	UNIT	
t_d	Delay time	$V_{DD} \geq V_{IT} + 0.2\text{ V}, \overline{MR} \geq 0.7 \times V_{DD}$. See timing diagram	60	100	140	ms	
$t_{(tout)}$	Watchdog time-out	$V_{DD} > V_{IT} + 0.2\text{ V}$, See timing diagram	0.48	0.8	1.12	s	
t_{PHL}	Propagation (delay) time, high-to-low-level output	V_{DD} to $\overline{\text{RESET}}$	$V_{IL} = V_{IT} - 0.2\text{ V}, V_{IH} = V_{IT} + 0.2\text{ V}$		2	5	μs
		PFI to \overline{PFO}	$V_{IL} = V(\text{PFI}) - 0.2\text{ V}, V_{IH} = V(\text{PFI}) + 0.2\text{ V}$		3		μs
		\overline{MR} to $\overline{\text{RESET}}$	$V_{DD} \geq V_{IT} + 0.2\text{ V}, V_{IL} = 0.3 \times V_{DD}, V_{IH} = 0.7 \times V_{DD}$		0.1	1	μs
Transition time		V_{DD} to V_{BAT}	$V_{IL} = V(\text{BAT}) - 0.2\text{ V}, V_{IH} = V(\text{BAT}) + 0.2\text{ V}, V(\text{BAT}) < V_{IT}$		3		μs

TPS3606-33 BATTERY-BACKUP SUPERVISOR FOR LOW-POWER PROCESSORS

SLVS335C – DECEMBER 2000 – REVISED JANUARY 2007

TYPICAL CHARACTERISTICS

Table of Graphs

			FIGURE
$r_{DS(on)}$	Static drain-source on-state resistance (V_{DD} to V_{OUT})	vs Output current	2
	Static drain-source on-state resistance (V_{BAT} to V_{OUT})	vs Output current	3
I_{DD}	Supply current	vs Supply voltage	4
		vs Battery supply	5
V_{IT}	Input threshold voltage at \overline{RESET}	vs Free-air temperature	6
V_{OH}	High-level output voltage at \overline{RESET}	vs High-level output current	7, 8
	High-level output voltage at \overline{PFO}		9, 10
V_{OL}	Low-level output voltage at \overline{RESET}	vs Low-level output current	11, 12
	Minimum pulse duration at V_{DD}	vs Threshold voltage overdrive at V_{DD}	13
	Minimum pulse duration at PFI	vs Threshold voltage overdrive at PFI	14

**STATIC DRAIN SOURCE ON-STATE RESISTANCE
(V_{DD} TO V_{OUT})
vs
OUTPUT CURRENT**

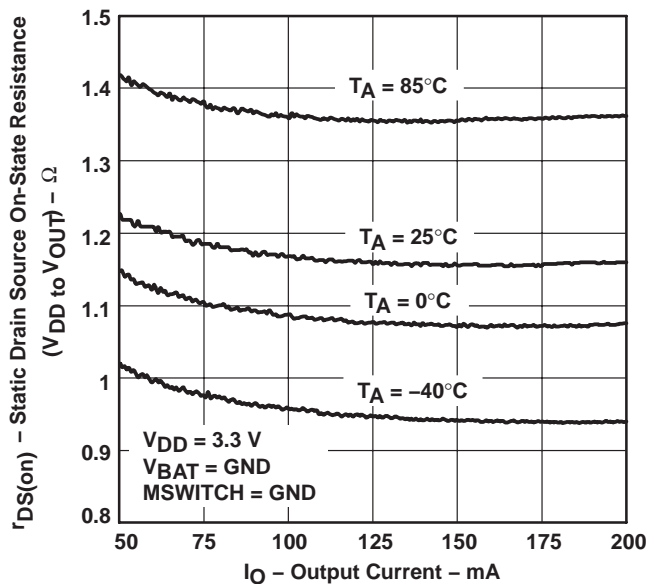

Figure 2

**STATIC DRAIN SOURCE ON-STATE RESISTANCE
(V_{BAT} TO V_{OUT})
vs
OUTPUT CURRENT**

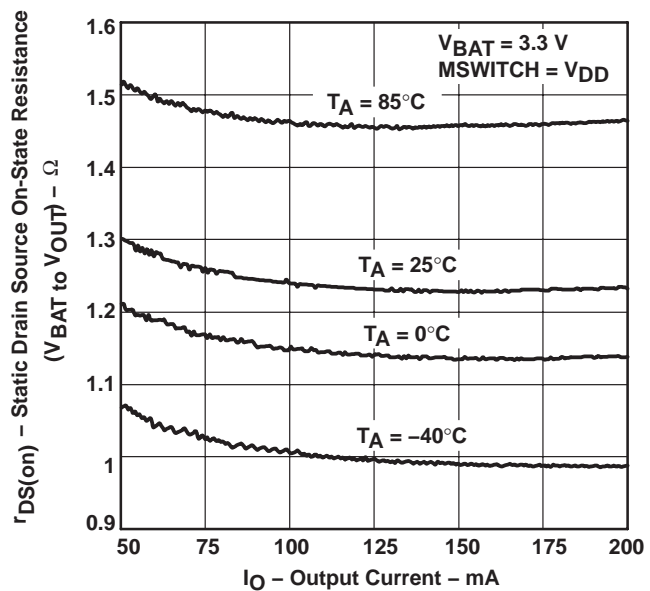
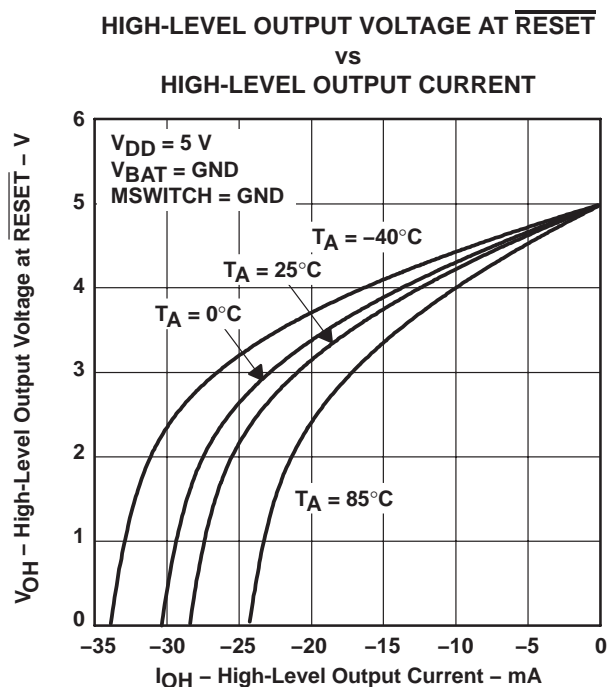
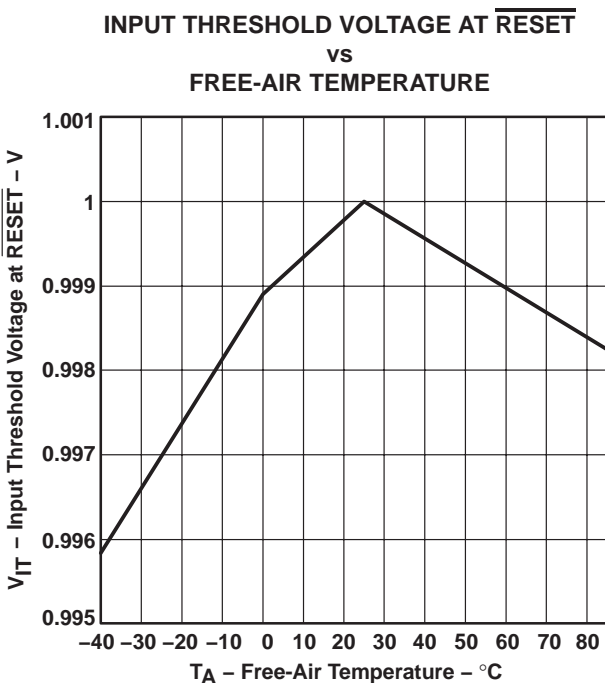
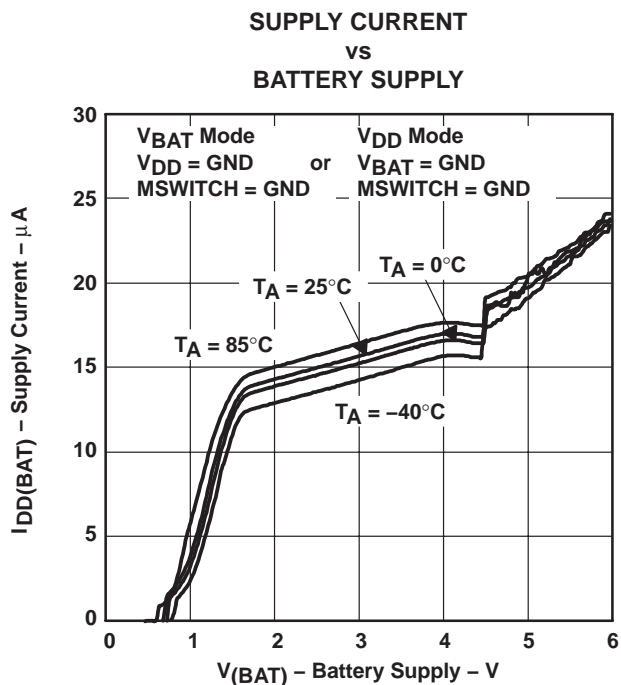
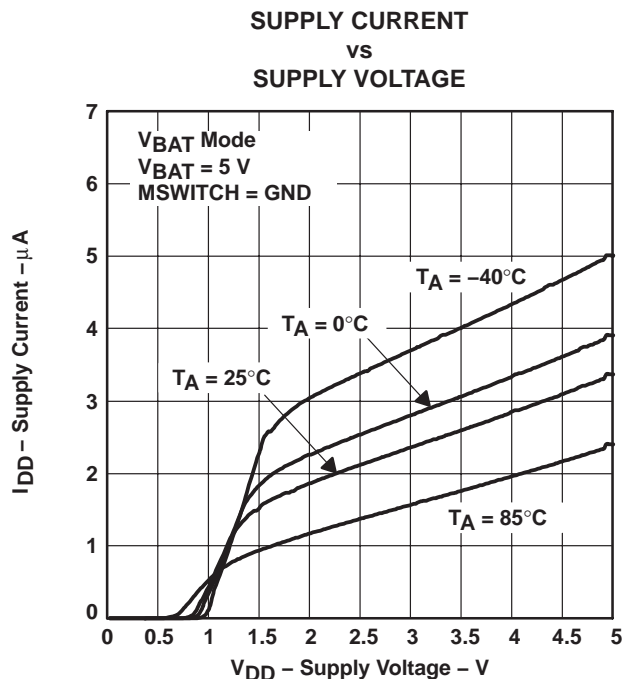

Figure 3

TYPICAL CHARACTERISTICS



TPS3606-33 BATTERY-BACKUP SUPERVISOR FOR LOW-POWER PROCESSORS

SLVS335C – DECEMBER 2000 – REVISED JANUARY 2007

TYPICAL CHARACTERISTICS

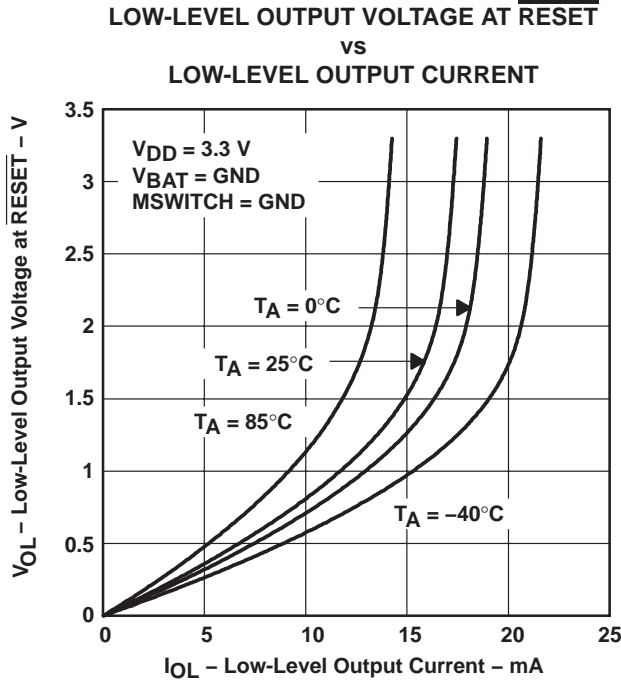
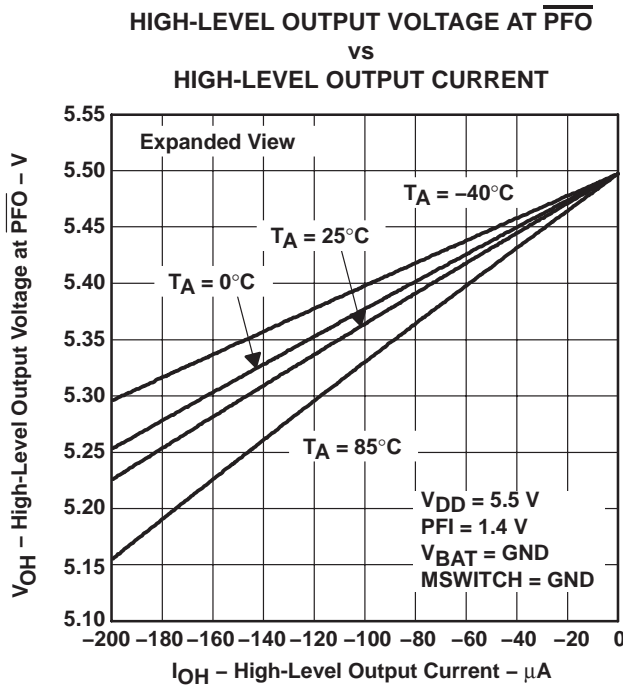
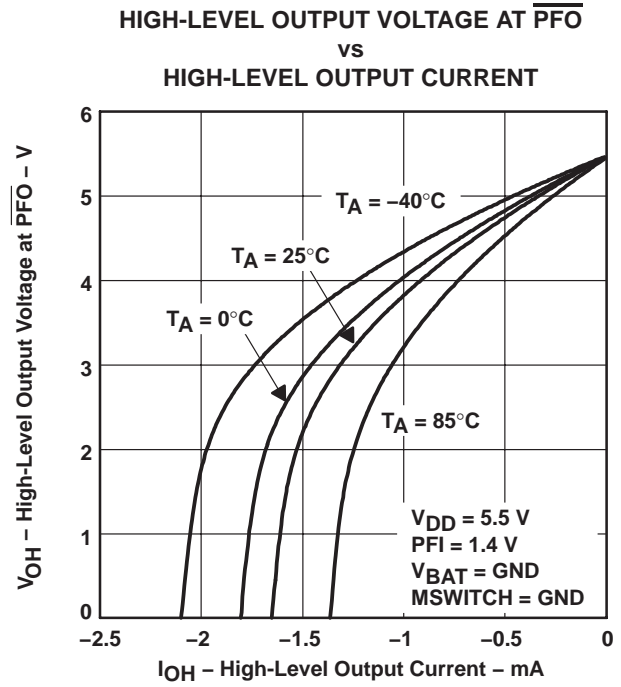
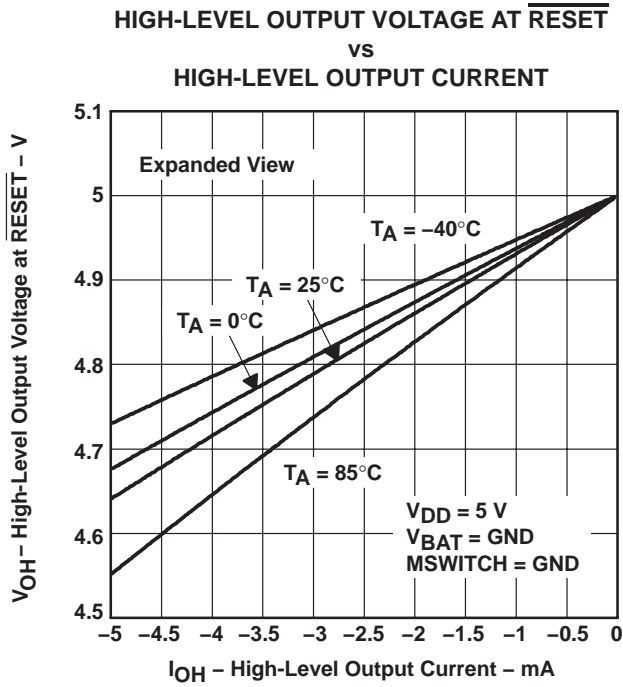

TYPICAL CHARACTERISTICS

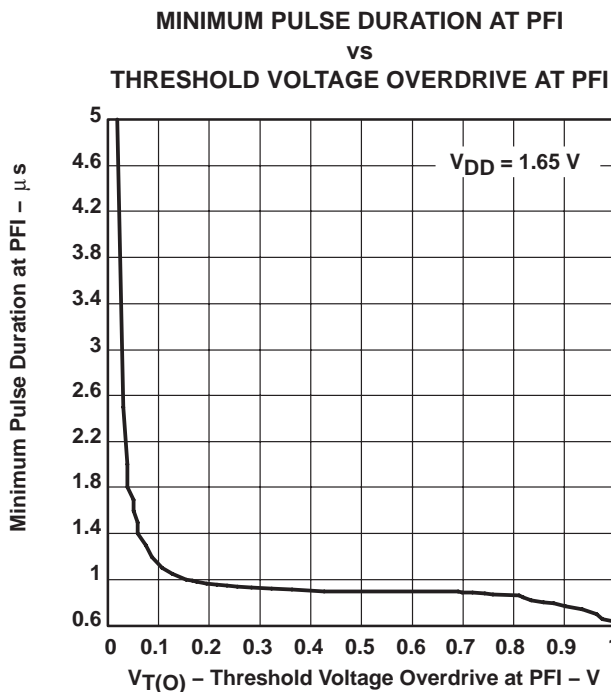
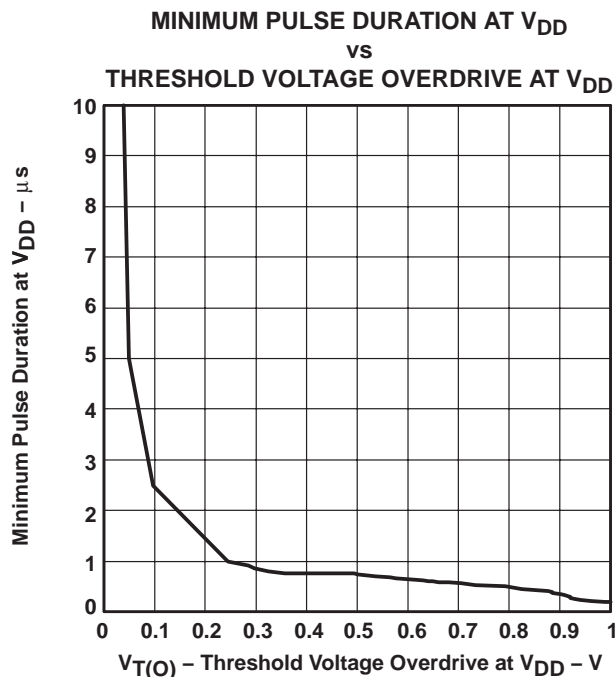
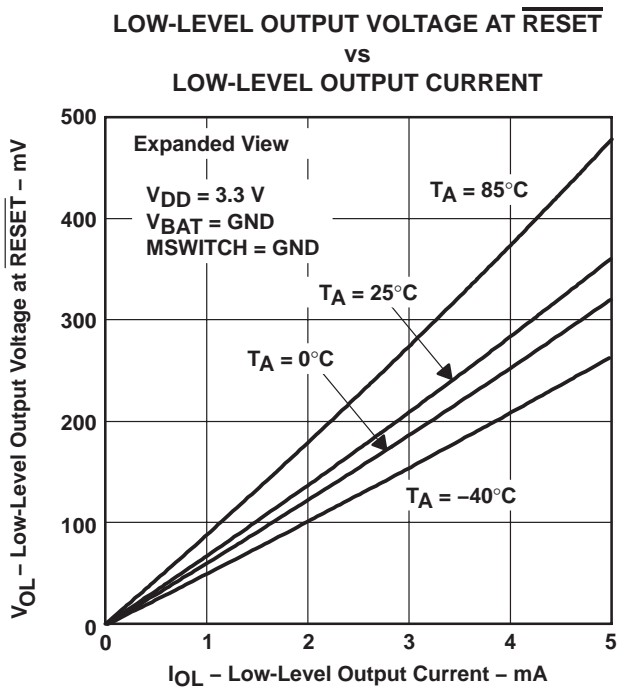

PACKAGING INFORMATION

Orderable Device	Status ⁽¹⁾	Package Type	Package Drawing	Pins	Package Qty	Eco Plan ⁽²⁾	Lead/Ball Finish	MSL Peak Temp ⁽³⁾
TPS3606-33DGS	ACTIVE	MSOP	DGS	10	80	Green (RoHS & no Sb/Br)	CU NIPDAU	Level-1-260C-UNLIM
TPS3606-33DGSG4	ACTIVE	MSOP	DGS	10	80	Green (RoHS & no Sb/Br)	CU NIPDAU	Level-1-260C-UNLIM
TPS3606-33DGSR	ACTIVE	MSOP	DGS	10	2500	Green (RoHS & no Sb/Br)	CU NIPDAU	Level-1-260C-UNLIM
TPS3606-33DGSRG4	ACTIVE	MSOP	DGS	10	2500	Green (RoHS & no Sb/Br)	CU NIPDAU	Level-1-260C-UNLIM

⁽¹⁾ The marketing status values are defined as follows:

ACTIVE: Product device recommended for new designs.

LIFEBUY: TI has announced that the device will be discontinued, and a lifetime-buy period is in effect.

NRND: Not recommended for new designs. Device is in production to support existing customers, but TI does not recommend using this part in a new design.

PREVIEW: Device has been announced but is not in production. Samples may or may not be available.

OBsolete: TI has discontinued the production of the device.

⁽²⁾ Eco Plan - The planned eco-friendly classification: Pb-Free (RoHS), Pb-Free (RoHS Exempt), or Green (RoHS & no Sb/Br) - please check <http://www.ti.com/productcontent> for the latest availability information and additional product content details.

TBD: The Pb-Free/Green conversion plan has not been defined.

Pb-Free (RoHS): TI's terms "Lead-Free" or "Pb-Free" mean semiconductor products that are compatible with the current RoHS requirements for all 6 substances, including the requirement that lead not exceed 0.1% by weight in homogeneous materials. Where designed to be soldered at high temperatures, TI Pb-Free products are suitable for use in specified lead-free processes.

Pb-Free (RoHS Exempt): This component has a RoHS exemption for either 1) lead-based flip-chip solder bumps used between the die and package, or 2) lead-based die adhesive used between the die and leadframe. The component is otherwise considered Pb-Free (RoHS compatible) as defined above.

Green (RoHS & no Sb/Br): TI defines "Green" to mean Pb-Free (RoHS compatible), and free of Bromine (Br) and Antimony (Sb) based flame retardants (Br or Sb do not exceed 0.1% by weight in homogeneous material)

⁽³⁾ MSL, Peak Temp. -- The Moisture Sensitivity Level rating according to the JEDEC industry standard classifications, and peak solder temperature.

Important Information and Disclaimer:The information provided on this page represents TI's knowledge and belief as of the date that it is provided. TI bases its knowledge and belief on information provided by third parties, and makes no representation or warranty as to the accuracy of such information. Efforts are underway to better integrate information from third parties. TI has taken and continues to take reasonable steps to provide representative and accurate information but may not have conducted destructive testing or chemical analysis on incoming materials and chemicals. TI and TI suppliers consider certain information to be proprietary, and thus CAS numbers and other limited information may not be available for release.

In no event shall TI's liability arising out of such information exceed the total purchase price of the TI part(s) at issue in this document sold by TI to Customer on an annual basis.

TAPE AND REEL INFORMATION

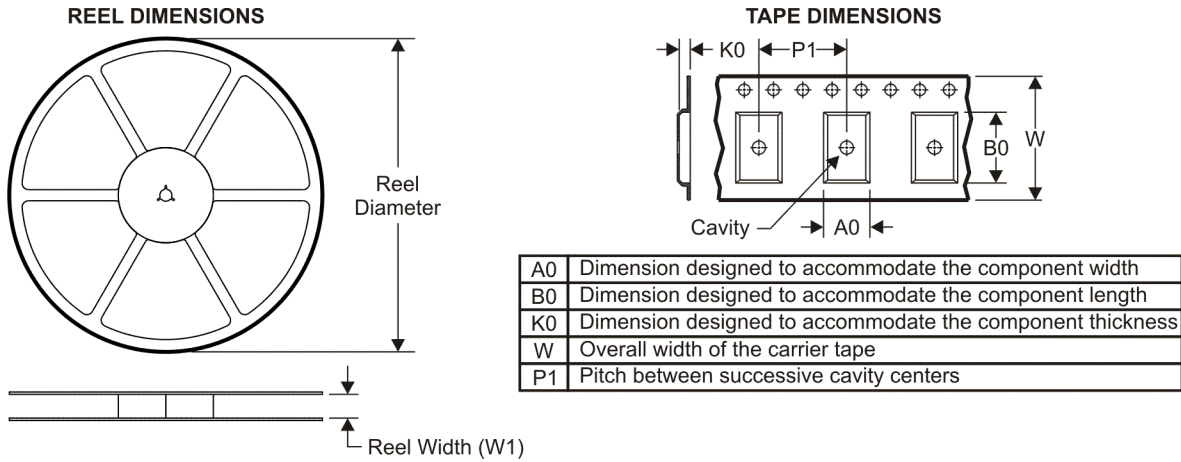

QUADRANT ASSIGNMENTS FOR PIN 1 ORIENTATION IN TAPE



*All dimensions are nominal

Device	Package Type	Package Drawing	Pins	SPQ	Reel Diameter (mm)	Reel Width W1 (mm)	A0 (mm)	B0 (mm)	K0 (mm)	P1 (mm)	W (mm)	Pin1 Quadrant
TPS3606-33DGSR	MSOP	DGS	10	2500	330.0	12.4	5.3	3.4	1.4	8.0	12.0	Q1

TAPE AND REEL BOX DIMENSIONS



*All dimensions are nominal

Device	Package Type	Package Drawing	Pins	SPQ	Length (mm)	Width (mm)	Height (mm)
TPS3606-33DGSR	MSOP	DGS	10	2500	358.0	335.0	35.0

DGS (S-PDSO-G10)

PLASTIC SMALL-OUTLINE PACKAGE

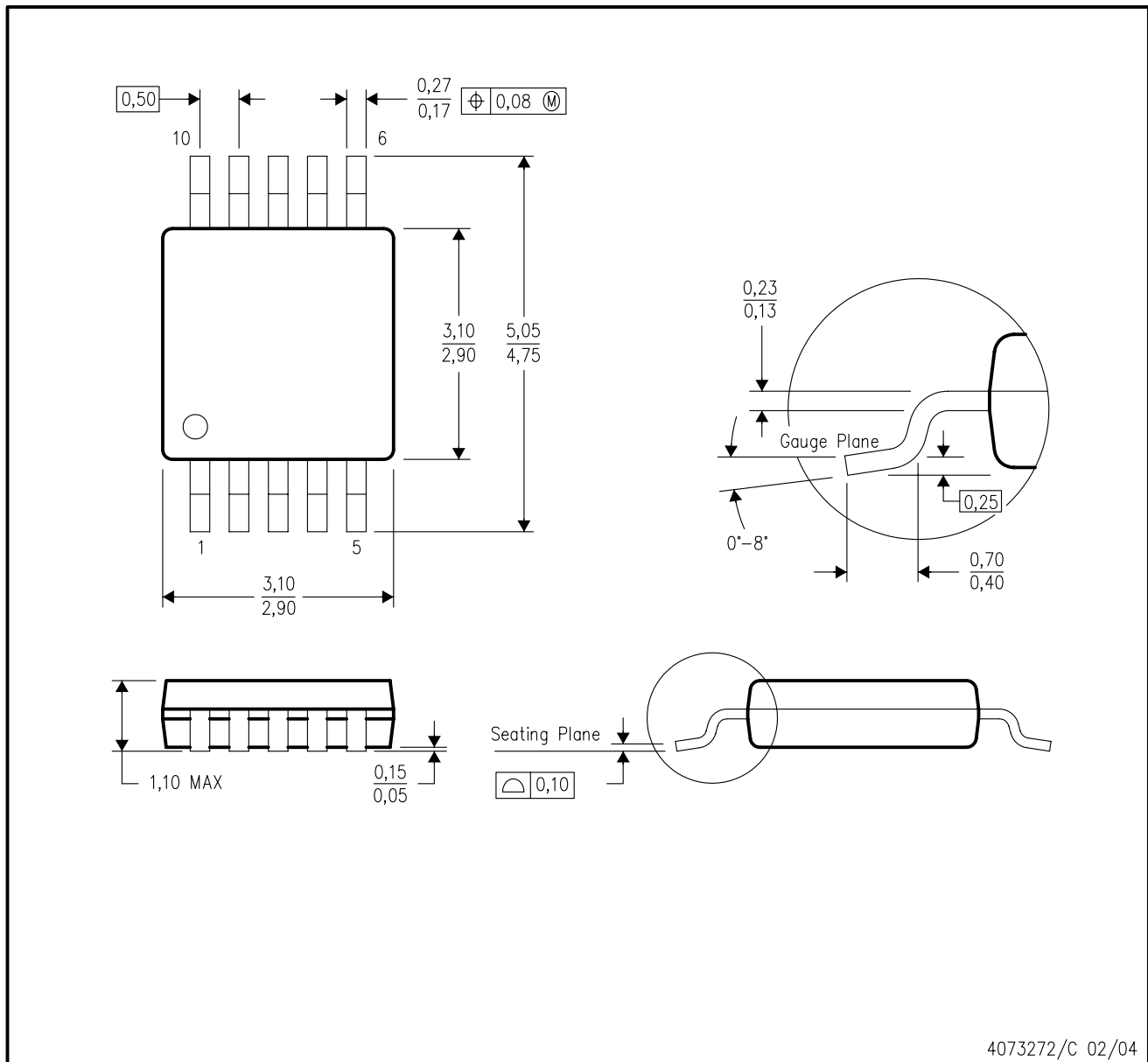

4073272/C 02/04

- NOTES:
- A. All linear dimensions are in millimeters.
 - B. This drawing is subject to change without notice.
 - C. Body dimensions do not include mold flash or protrusion.
 - D. Falls within JEDEC MO-187 variation BA.

IMPORTANT NOTICE

Texas Instruments Incorporated and its subsidiaries (TI) reserve the right to make corrections, modifications, enhancements, improvements, and other changes to its products and services at any time and to discontinue any product or service without notice. Customers should obtain the latest relevant information before placing orders and should verify that such information is current and complete. All products are sold subject to TI's terms and conditions of sale supplied at the time of order acknowledgment.

TI warrants performance of its hardware products to the specifications applicable at the time of sale in accordance with TI's standard warranty. Testing and other quality control techniques are used to the extent TI deems necessary to support this warranty. Except where mandated by government requirements, testing of all parameters of each product is not necessarily performed.

TI assumes no liability for applications assistance or customer product design. Customers are responsible for their products and applications using TI components. To minimize the risks associated with customer products and applications, customers should provide adequate design and operating safeguards.

TI does not warrant or represent that any license, either express or implied, is granted under any TI patent right, copyright, mask work right, or other TI intellectual property right relating to any combination, machine, or process in which TI products or services are used. Information published by TI regarding third-party products or services does not constitute a license from TI to use such products or services or a warranty or endorsement thereof. Use of such information may require a license from a third party under the patents or other intellectual property of the third party, or a license from TI under the patents or other intellectual property of TI.

Reproduction of TI information in TI data books or data sheets is permissible only if reproduction is without alteration and is accompanied by all associated warranties, conditions, limitations, and notices. Reproduction of this information with alteration is an unfair and deceptive business practice. TI is not responsible or liable for such altered documentation. Information of third parties may be subject to additional restrictions.

Resale of TI products or services with statements different from or beyond the parameters stated by TI for that product or service voids all express and any implied warranties for the associated TI product or service and is an unfair and deceptive business practice. TI is not responsible or liable for any such statements.

TI products are not authorized for use in safety-critical applications (such as life support) where a failure of the TI product would reasonably be expected to cause severe personal injury or death, unless officers of the parties have executed an agreement specifically governing such use. Buyers represent that they have all necessary expertise in the safety and regulatory ramifications of their applications, and acknowledge and agree that they are solely responsible for all legal, regulatory and safety-related requirements concerning their products and any use of TI products in such safety-critical applications, notwithstanding any applications-related information or support that may be provided by TI. Further, Buyers must fully indemnify TI and its representatives against any damages arising out of the use of TI products in such safety-critical applications.

TI products are neither designed nor intended for use in military/aerospace applications or environments unless the TI products are specifically designated by TI as military-grade or "enhanced plastic." Only products designated by TI as military-grade meet military specifications. Buyers acknowledge and agree that any such use of TI products which TI has not designated as military-grade is solely at the Buyer's risk, and that they are solely responsible for compliance with all legal and regulatory requirements in connection with such use.

TI products are neither designed nor intended for use in automotive applications or environments unless the specific TI products are designated by TI as compliant with ISO/TS 16949 requirements. Buyers acknowledge and agree that, if they use any non-designated products in automotive applications, TI will not be responsible for any failure to meet such requirements.

Following are URLs where you can obtain information on other Texas Instruments products and application solutions:

Products

Amplifiers	amplifier.ti.com
Data Converters	dataconverter.ti.com
DSP	dsp.ti.com
Clocks and Timers	www.ti.com/clocks
Interface	interface.ti.com
Logic	logic.ti.com
Power Mgmt	power.ti.com
Microcontrollers	microcontroller.ti.com
RFID	www.ti-rfid.com
RF/IF and ZigBee® Solutions	www.ti.com/lprf

Applications

Audio	www.ti.com/audio
Automotive	www.ti.com/automotive
Broadband	www.ti.com/broadband
Digital Control	www.ti.com/digitalcontrol
Medical	www.ti.com/medical
Military	www.ti.com/military
Optical Networking	www.ti.com/opticalnetwork
Security	www.ti.com/security
Telephony	www.ti.com/telephony
Video & Imaging	www.ti.com/video
Wireless	www.ti.com/wireless

Mailing Address: Texas Instruments, Post Office Box 655303, Dallas, Texas 75265
Copyright © 2008, Texas Instruments Incorporated