



ULTRA-LOW VOLTAGE PROCESSOR SUPERVISORY CIRCUITS

 Check for Samples: [TPS3123-xx](#), [TPS3124-xx](#), [TPS3125-xx](#), [TPS3126-xx](#), [TPS3128-xx](#)

FEATURES

- Minimum Supply Voltage of 0.75 V
- Supply Voltage Supervision Range:
 - 1.2 V, 1.5 V, 1.8 V (TPS312x)
 - 3 V (TPS3125 Devices Only)
 - Other Versions on Request
- Power-On Reset Generator With Fixed Delay Time of 180 ms
- Manual Reset Input (TPS3123/5/6/8)
- Watchdog Timer Retriggeres the $\overline{\text{RESET}}$ Output at $V_{\text{DD}} \geq V_{\text{IT}}$
- Supply Current of 14 μA (Typ)
- Small SOT23-5 Package
- Temperature Range of -40°C to $+85^{\circ}\text{C}$
- Reset Output Available in Push-Pull (Active Low and High) and Open-Drain (Active-Low)

APPLICATIONS

- Applications Using Low Voltage DSPs, Microcontrollers, or Microprocessors
- Portable/Battery-Powered Equipment
- Wireless Communication Systems
- Programmable Controls
- Industrial Equipment
- Notebook/Desktop Computers
- Intelligent Instruments

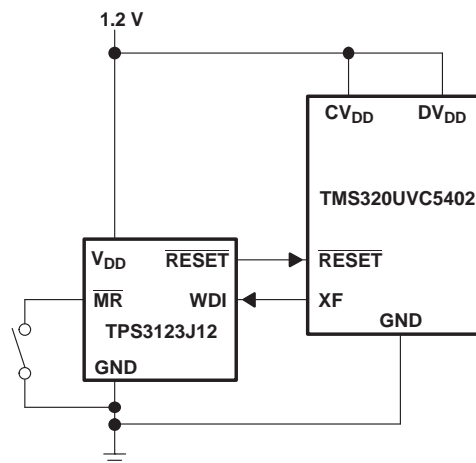
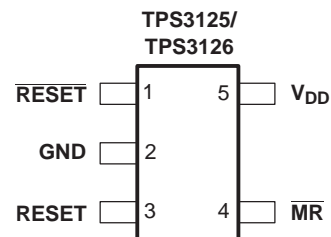
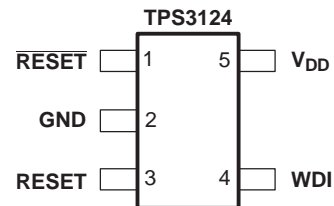
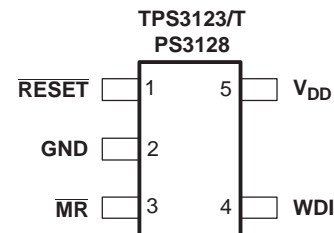
**DBV PACKAGE
(TOP VIEW)**

Figure 1. Typical Low-Voltage DSP Application

Please be aware that an important notice concerning availability, standard warranty, and use in critical applications of Texas Instruments semiconductor products and disclaimers thereto appears at the end of this data sheet.

All trademarks are the property of their respective owners.

DESCRIPTION

The TPS312x family of ultralow voltage processor supervisory circuits provides circuit initialization and timing supervision, primarily for DSP and processor-based systems.

During power-on, $\overline{\text{RESET}}$ is asserted when the supply voltage (V_{DD}) becomes higher than 0.75 V. Thereafter, the supply voltage supervisor monitors V_{DD} and keeps $\overline{\text{RESET}}$ output active as long as V_{DD} remains below the threshold voltage (V_{IT}). An internal timer delays the return of the output to the inactive state (high) to ensure proper system reset. The delay time, $t_d = 180$ ms, starts after V_{DD} has risen above the threshold voltage (V_{IT}).

When the supply voltage drops below the threshold voltage (V_{IT}), the output becomes active (low) again. No external components are required. All the devices of this family have a fixed-sense threshold voltage (V_{IT}) set by a high precision internal voltage divider.

The TPS3123/5/6/8 devices incorporate a manual reset input, $\overline{\text{MR}}$. A low level at $\overline{\text{MR}}$ causes $\overline{\text{RESET}}$ to become active. The TPS3124 devices do not have the input MR, but include a high-level output RESET same as the TPS3125 and TPS3126 devices. In addition, the TPS3123/4/8 have a watchdog timer that needs to be triggered periodically by a positive or negative transition at $\overline{\text{WDI}}$. When the supervising system fails to retrigger the watchdog circuit within the time-out interval $t_{\text{out}} = 0.8$ s, $\overline{\text{RESET}}$ output becomes active for the time period (t_d). This event also reinitializes the watchdog timer.

The circuits are available in a 5-pin SOT23-5 package. The TPS312x devices are characterized for operation over a temperature range of -40°C to $+85^\circ\text{C}$.

Table 1. PACKAGE INFORMATION, STANDARD VERSIONS⁽¹⁾⁽²⁾

T_A	DEVICE NAME		THRESHOLD VOLTAGE	MARKING
-40°C to $+85^\circ\text{C}$	TPS3123J12DBVR ⁽³⁾	TPS3123J12DBVT ⁽⁴⁾	1.08 V	PBNI
	TPS3123G15DBVR ⁽³⁾	TPS3123G15DBVT ⁽⁴⁾	1.40 V	PBOI
	TPS3123J18DBVR ⁽³⁾	TPS3123J18DBVT ⁽⁴⁾	1.62 V	PBPI
	TPS3124J12DBVR ⁽³⁾	TPS3124J12DBVT ⁽⁴⁾	1.08 V	PBQI
	TPS3124G15DBVR ⁽³⁾	TPS3124G15DBVT ⁽⁴⁾	1.40 V	PBRI
	TPS3124J18DBVR ⁽³⁾	TPS3124J18DBVT ⁽⁴⁾	1.62 V	PBSI
	TPS3125J12DBVR ⁽³⁾	TPS3125J12DBVT ⁽⁴⁾	1.08 V	PBTI
	TPS3125G15DBVR ⁽³⁾	TPS3125G15DBVT ⁽⁴⁾	1.40 V	PBUI
	TPS3125J18DBVR ⁽³⁾	TPS3125J18DBVT ⁽⁴⁾	1.62 V	PBVI
	TPS3125L30DBVR ⁽³⁾	TPS3125L30DBVT ⁽⁴⁾	2.64 V	PBXI
	TPS3126E12DBVR ⁽³⁾	TPS3126E12DBVT ⁽⁴⁾	1.14 V	PFOI
	TPS3126E15DBVR ⁽³⁾	TPS3126E15DBVT ⁽⁴⁾	1.43 V	PFPI
	TPS3126E18DBVR ⁽³⁾	TPS3126E18DBVT ⁽⁴⁾	1.71 V	PFQI
	TPS3128E15DBVR ⁽³⁾	TPS3128E15DBVT ⁽⁴⁾	1.43 V	PFSI
TPS3128E18DBVR ⁽³⁾	TPS3128E18DBVT ⁽⁴⁾	1.71 V	PFTI	

(1) Other versions available. Contact Texas Instruments for details; minimum order quantities apply.

(2) For the most current package and ordering information see the Package Option Addendum at the end of this document, or visit the device product folder at www.ti.com.

(3) The DBVR passive indicates tape and reel of 3000 parts.

(4) The DBVT passive indicates tape and reel of 250 parts.

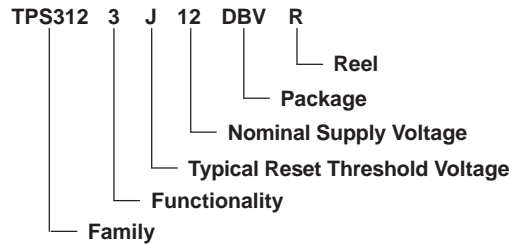
Table 2. Ordering Information Application Specific Versions ⁽¹⁾

DEVICE NAME	NOMINAL SUPPLY VOLTAGE, V_{NOM}	DEVICE NAME	TYPICAL RESET THRESHOLD VOLTAGE- V_{IT-}
TPS312xx12DBV	1.2 V	TPS312xAxxDBV	$V_{NOM} -1\%$
TPS312xx15DBV	1.5 V	TPS312xBxxDBV	$V_{NOM} -2\%$
TPS312xx18DBV	1.8 V	TPS312xCxxDBV	$V_{NOM} -3\%$
TPS312xx30DBV	3.0 V	TPS312xDxxDBV	$V_{NOM} -4\%$
		TPS312xExxDBV	$V_{NOM} -5\%$
		TPS312xFxxDBV	$V_{NOM} -6\%$
		TPS312xGxxDBV	$V_{NOM} -7\%$
		TPS312xHxxDBV	$V_{NOM} -8\%$
		TPS312xIxxDBV	$V_{NOM} -9\%$
		TPS312xJxxDBV	$V_{NOM} -10\%$
		TPS312xKxxDBV	$V_{NOM} -11\%$
		TPS312xLxxDBV	$V_{NOM} -12\%$
		TPS312xMxxDBV	$V_{NOM} -13\%$
		TPS312xNxxDBV	$V_{NOM} -14\%$
		TPS312xOxxDBV	$V_{NOM} -15\%$

(1) For the application-specific versions contact Texas Instruments for availability, lead time, and minimum order quantities.

Table 3. Function Tables

TPS3123/8			TPS3124			TPS3125/6			
\overline{MR}	$V_{DD} > V_{IT}$	\overline{RESET}	$V_{DD} > V_{IT}$	\overline{RESET}	RESET	\overline{MR}	$V_{DD} > V_{IT}$	\overline{RESET}	RESET
L	0	L	0	L	H	L	0	L	H
L	1	L	1	H	L	L	1	L	H
H	0	L				H	0	L	H
H	1	H				H	1	H	L

Table 4. Reset Topology

DEVICES	OPEN DRAIN	PUSH-PULL
TPS3123		X
TPS3124		X
TPS3125		X
TPS3126	X	
TPS3128	X	

Figure 2. FUNCTIONAL BLOCK DIAGRAM

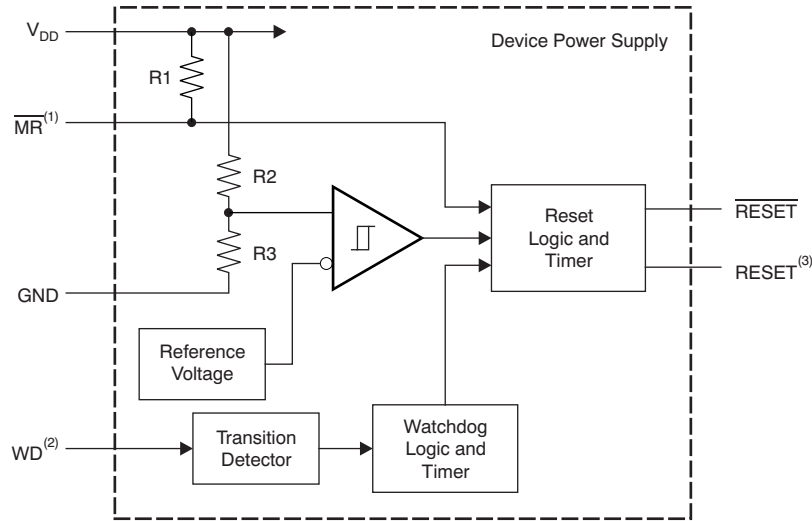

- NOTES:
 (1) TPS3123/5/6/8
 (2) TPS3123/4/8
 (3) TPS3124/5/6

Figure 3. TIMING DIAGRAM TPS3123/5/6/8

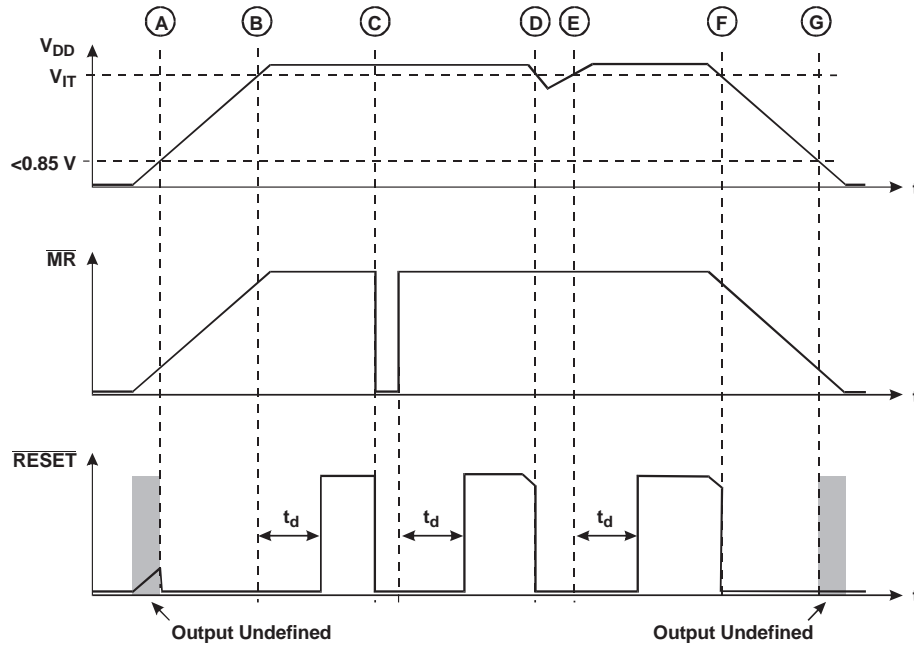
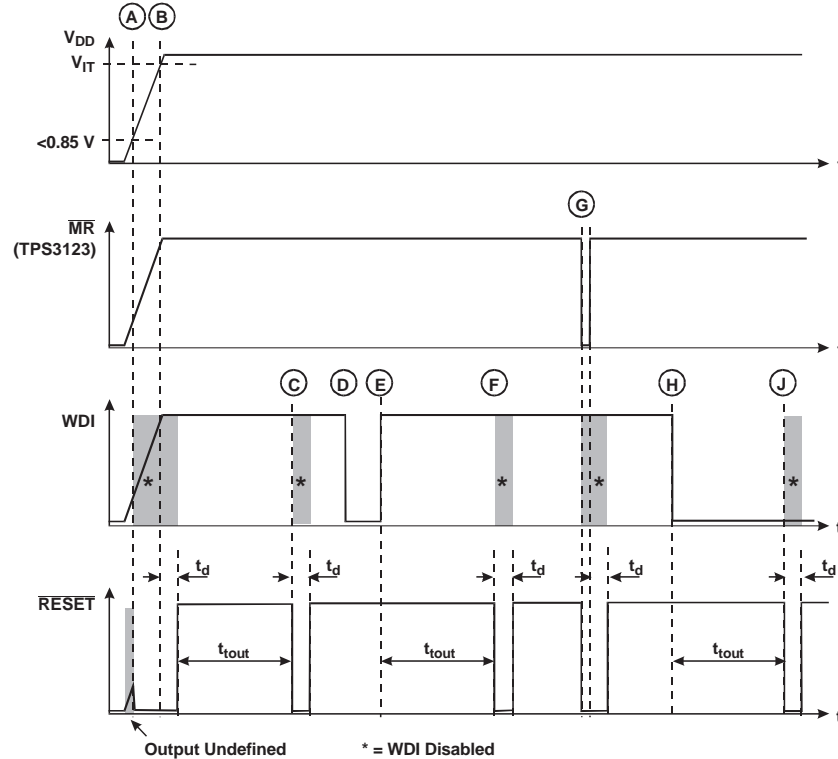

Figure 4. TIMING DIAGRAM TPS3123/4//8



ABSOLUTE MAXIMUM RATINGS

over operating free-air temperature range (unless otherwise noted)⁽¹⁾

	UNIT
Manual reset, $\overline{\text{MR}}$	-0.3 V to V _{DD} + 0.6 V
$\overline{\text{RESET}}$	-0.3 V to V _{DD} + 0.6 V
V _{DD} Supply voltage	3.6 V
WDI Watchdog input	-0.3 V to V _{DD} + 0.6 V
I _{OL} Maximum low output current	5 mA
I _{OH} Maximum high output current	-5 mA
I _{IK} Input clamp current (V _I < 0 or V _I > V _{DD})	±10 mA
I _{OK} Output clamp current (V _O < 0 or V _O > V _{DD})	±10 mA
Continuous total power dissipation	See Dissipation Rating Table
T _A Operating free-air temperature range,	-40°C to +85°C
T _{stg} Storage temperature range,	-65°C to +150°C
Soldering temperature	+260°C
Open drain RESET outputs	-0.3 V to V _{DD} + 0.3 V

(1) Stresses beyond those listed under *Absolute Maximum Ratings* may cause permanent damage to the device. These are stress ratings only, and functional operation of the device at these or any other conditions beyond those indicated under *Recommended Operating Conditions* is not implied. Exposure to absolute-maximum-rated conditions for extended periods may affect device reliability.

DISSIPATION RATING TABLE

PACKAGE	T _A ≤ +25°C POWER RATING	DERATING FACTOR ABOVE T _A = +25°C	T _A = +70°C POWER RATING	T _A = +85°C POWER RATING
DBV	437 mW	3.5 mW/°C	280 mW	227 mW

RECOMMENDED OPERATING CONDITIONS

at specified temperature range.

		MIN	MAX	UNIT
V _{DD}	Supply voltage	T _A = 0°C to +85°C		V
		T _A = -40°C to +85°C		
V _{DD}	Manual reset voltage	0.0	V _{DD} + 0.3	V
V _{WD1}	Watchdog input voltage	0	V _{DD} + 0.3	V
V _{IH}	High-level input voltage	0.7 × V _{DD}		V
V _{IL}	Low-level input voltage	0.3 × V _{DD}		V
Δ t/ΔV	Input transition rise and fall rate at WDI	1		μs/V
T _A	Operating free-air temperature range	40	+85	°C

ELECTRICAL CHARACTERISTICS

over recommended operating free-air temperature range (unless otherwise noted).

PARAMETER		TEST CONDITIONS		MIN	TYP	MAX	UNIT
$\overline{\text{MR}}$ pullup resistor (internal)				27			kΩ
I _{IH}	High-level input current	WDI	WDI = V _{DD} = 3.3 V	1		1	μA
		$\overline{\text{MR}}$	$\overline{\text{MR}}$ = 0.7 × V _{DD} , V _{DD} = 3.3 V	20		55	
I _{IL}	Low-level input current	WDI	WDI = 0 V, V _{DD} = 3.3 V	1		1	μA
		$\overline{\text{MR}}$	$\overline{\text{MR}}$ = 0 V, V _{DD} = 3.3 V	80		170	
I _{OH}	High-level output current (leakage into $\overline{\text{RESET}}$ pin)	TPS3126-xx, TPS3128-xx	V _{DD} = V _{OH} = 3.3 V			200	nA
V _{OH}	High-level output voltage (TPS3123/4/5 only)	$\overline{\text{RESET}}$	V _{DD} = 1.5 V, I _{OH} = -1 mA	0.8 × V _{DD}			V
			V _{DD} = 3.3 V, I _{OH} = -4.5 mA				
		RESET	V _{DD} = 0.75 V, I _{OH} = -8 μA				
			V _{DD} = 1.5 V, I _{OH} = -1 mA				
V _{OL}	Low-level output voltage	$\overline{\text{RESET}}$	V _{DD} = 0.75 V, I _{OL} = 15 μA	0.2 × V _{DD}			V
			V _{DD} = 1.5 V, I _{OL} = 1.4 mA				
		RESET	V _{DD} = 1.5 V, I _{OL} = 1.4 mA				
			V _{DD} = 3.3 V, I _{OL} = 3 mA				
V _{IT-}	Negative-going input threshold voltage ⁽¹⁾	TPS312xJ12	T _A = -40°C to +85°C	1.04	1.08	1.12	V
		TPS312xG15		1.35	1.40	1.45	
		TPS312xJ18		1.56	1.62	1.68	
		TPS312xL30		2.57	2.64	2.71	
		TPS312xE12		1.10	1.14	1.18	
		TPS312xE15		1.38	1.43	1.48	
		TPS312xE18		1.65	1.71	1.77	
V _{hys}	Hysteresis at V _{DD} input	1 V < V _{IT-} < 1.4 V		15			mV
		1.4 V < V _{IT-} < 2 V		20			
		2 V < V _{IT-} < 3 V		30			
I _{DD}	Supply current	TPS3123-xx, TPS3124-xx, TPS3128-xx	$\overline{\text{WDI}}$ = V _{DD} , $\overline{\text{MR}}$ unconnected	V _{DD} = 0.75 V	14		μA
				V _{DD} = 3.3 V	22	30	
		TPS3125-xx, TPS3126-xx ⁽²⁾	$\overline{\text{MR}}$ unconnected	V _{DD} = 0.75 V	14		
				V _{DD} = 3.3 V	18	25	
C _i	Input capacitance at $\overline{\text{MR}}$, WDI	V _I = 0 V to 3.3 V		5			pF

(1) To ensure best stability of the threshold voltage, a bypass capacitor (ceramic, 0.1 μF) should be placed near the supply terminal.

(2) The supply current during delay time t_d is typical 5 μA higher.

TIMING REQUIREMENTS

 at $R_L = 1\text{ M}\Omega$, $C_L = 50\text{ pF}$, $T_A = +25^\circ\text{C}$.

PARAMETER		TEST CONDITIONS	MIN	TYP	MAX	UNIT	
t_w	Pulse width	At V_{DD}	$V_{IH} = V_{IT-} + 0.2\text{ V}$, $V_{IL} = V_{IT-} - 0.2\text{ V}$			6	μs
		At $\overline{\text{MR}}$	$V_{DD} \geq V_{IT-} + 0.2\text{ V}$, $V_{IL} = 0.3 \times V_{DD}$, $V_{IH} = 0.7 \times V_{DD}$			1	
		At WDI				0.1	

SWITCHING CHARACTERISTICS

 at $R_L = 1\text{ M}\Omega$, $C_L = 50\text{ pF}$, $T_A = +25^\circ\text{C}$.

PARAMETER		TEST CONDITIONS	MIN	TYP	MAX	UNIT	
t_{out}	Watchdog time out	$V_{DD} \geq V_{IT-} + 0.2\text{ V}$, See timing diagram	0.8	1.4	2.1	s	
t_d	Delay time	$V_{DD} > V_{IT-} + 0.2\text{ V}$, See timing diagram	100	180	260	ms	
t_{PHL}	Propagation delay time, high-to-low-level output	$\overline{\text{MR}}$ to $\overline{\text{RESET}}$ delay (TPS3123/5/6/8)	$V_{DD} \geq V_{IT-} + 0.2\text{ V}$, $V_{IL} = 0.2 \times V_{DD}$, $V_{IH} = 0.8 \times V_{DD}$			0.1	μs
t_{PLH}	Propagation delay time, low-to-high-level output	$\overline{\text{MR}}$ to $\overline{\text{RESET}}$ delay (TPS3125/6)				0.1	
t_{PHL}	Propagation delay time, high-to-low-level output	V_{DD} to $\overline{\text{RESET}}$ delay	$V_{IL} = V_{IT-} - 0.2\text{ V}$, $V_{IH} = V_{IT-} + 0.2\text{ V}$			10	μs
t_{PLH}	Propagation delay time, low-to-high-level output	V_{DD} to $\overline{\text{RESET}}$ delay (TPS3124/5/6)				10	

TYPICAL CHARACTERISTICS

SUPPLY CURRENT
 vs
 SUPPLY VOLTAGE

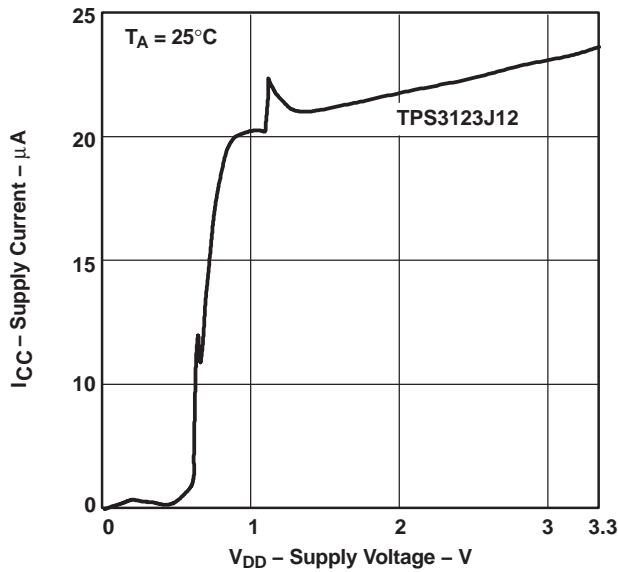

Figure 5.

LOW-LEVEL OUTPUT VOLTAGE
 vs
 LOW-LEVEL OUTPUT CURRENT

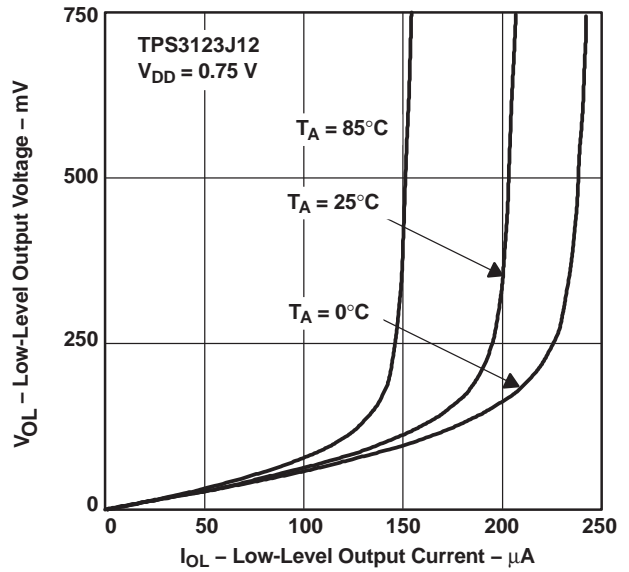

Figure 6.

LOW-LEVEL OUTPUT VOLTAGE
 vs
 LOW-LEVEL OUTPUT CURRENT

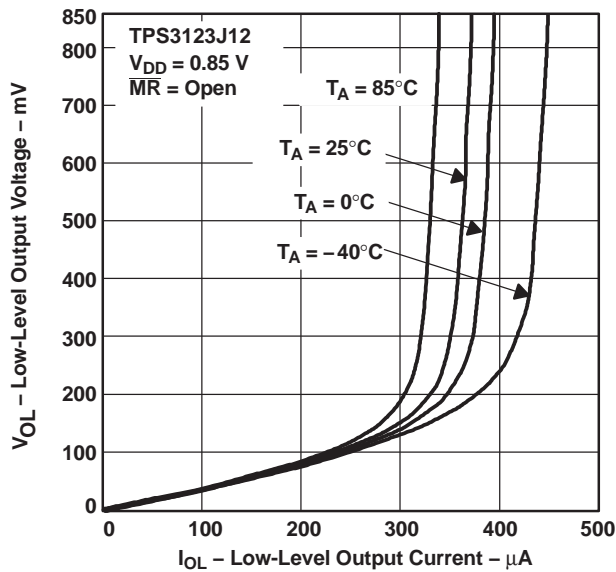

Figure 7.

LOW-LEVEL OUTPUT VOLTAGE
 vs
 LOW-LEVEL OUTPUT CURRENT

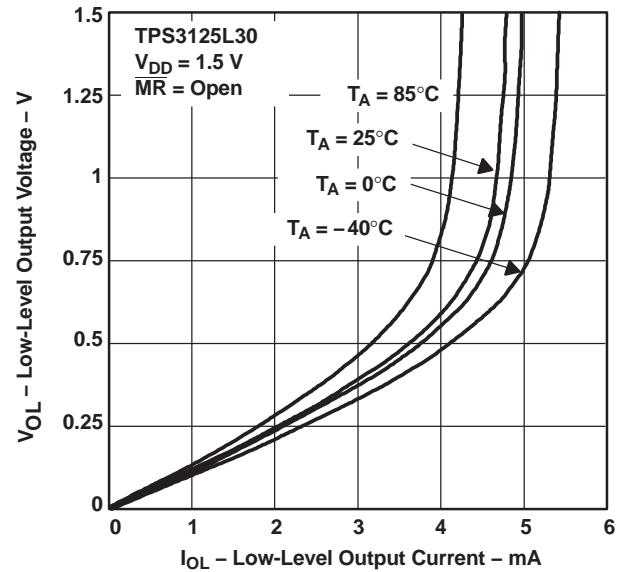

Figure 8.

TYPICAL CHARACTERISTICS (continued)

LOW-LEVEL OUTPUT VOLTAGE
 vs
 LOW-LEVEL OUTPUT CURRENT

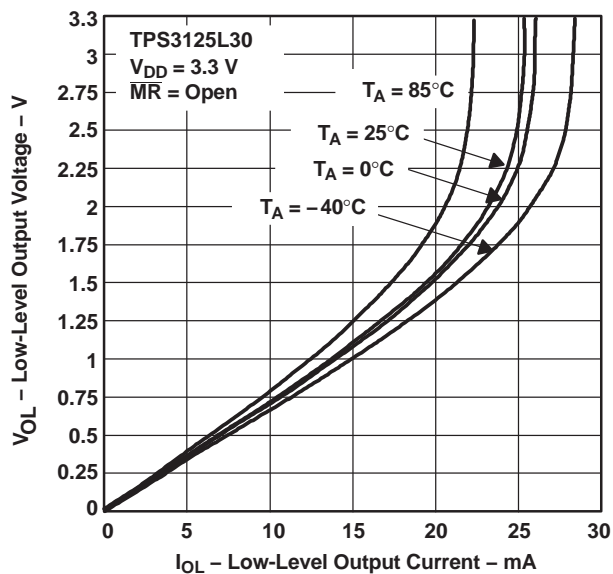

Figure 9.

HIGH-LEVEL OUTPUT VOLTAGE
 vs
 HIGH-LEVEL OUTPUT CURRENT

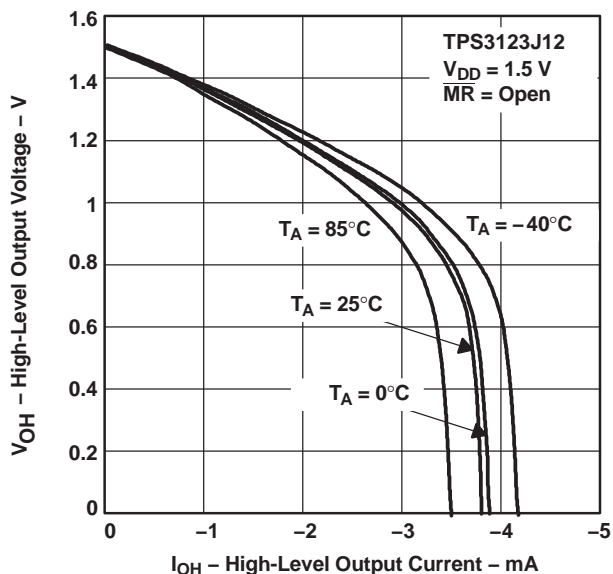

Figure 10.

HIGH-LEVEL OUTPUT VOLTAGE
 vs
 HIGH-LEVEL OUTPUT CURRENT

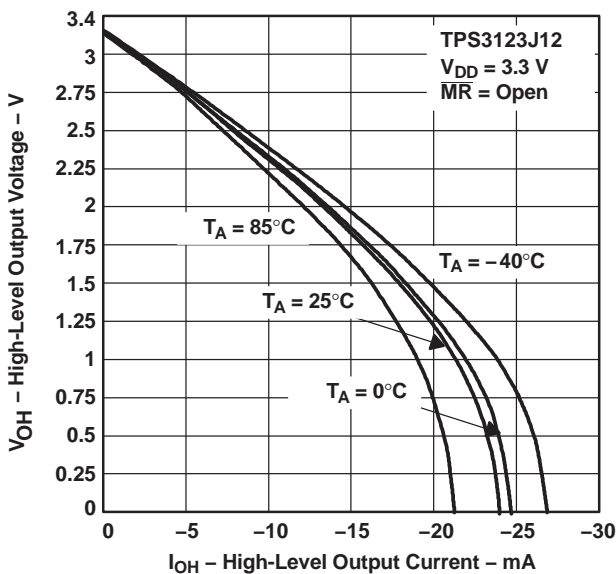

Figure 11.

NORMALIZED INPUT THRESHOLD VOLTAGE
 vs
 FREE-AIR TEMPERATURE

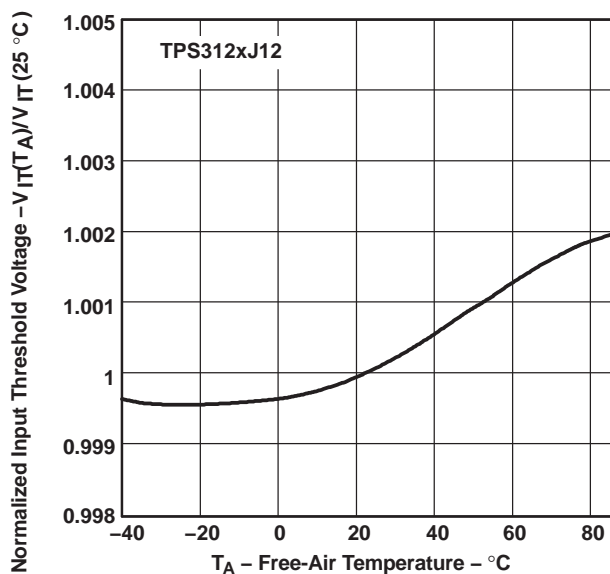

Figure 12.

TYPICAL CHARACTERISTICS (continued)

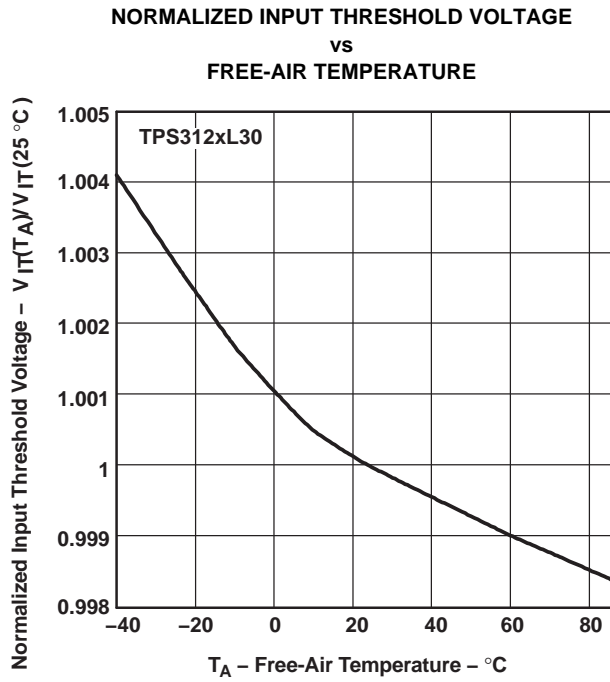

Figure 13.

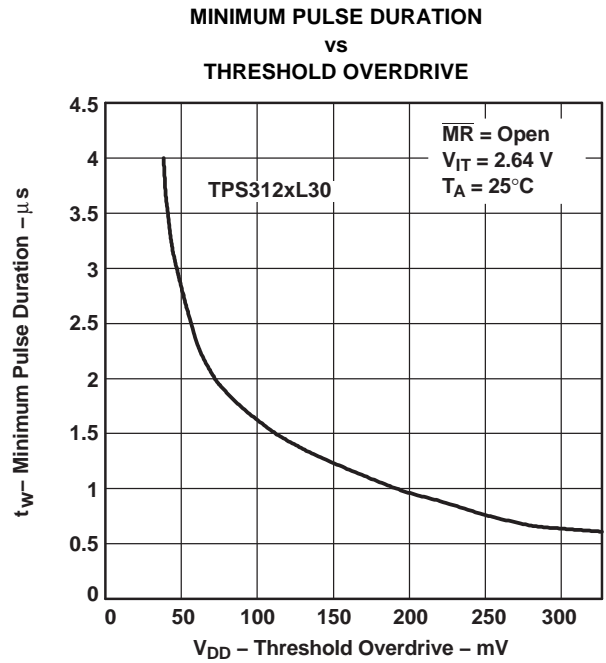

Figure 14.

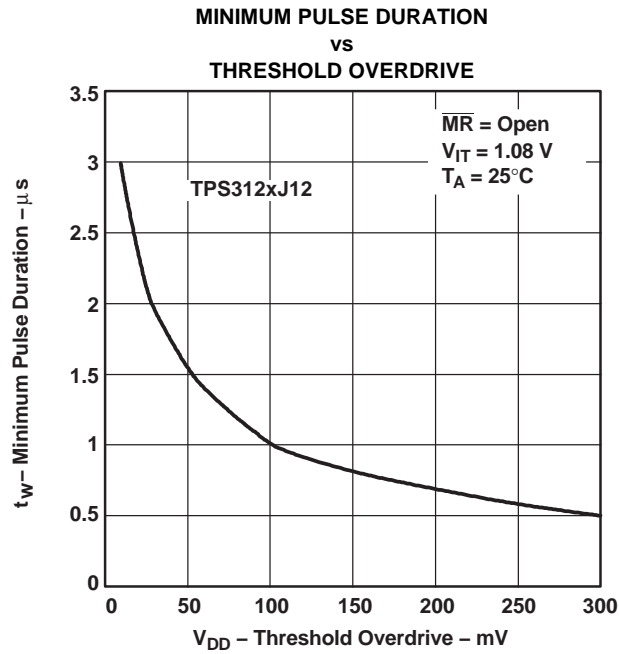

Figure 15.

REVISION HISTORY

NOTE: Page numbers for previous revisions may differ from page numbers in the current version.

Changes from Revision D (December, 2006) to Revision E	Page
• Removed <i>TPS3128E12DBVR</i> from list of orderable devices in Table 1	2

PACKAGING INFORMATION

Orderable Device	Status ⁽¹⁾	Package Type	Package Drawing	Pins	Package Qty	Eco Plan ⁽²⁾	Lead/ Ball Finish	MSL Peak Temp ⁽³⁾	Samples (Requires Login)
TPS3123G15DBVR	ACTIVE	SOT-23	DBV	5	3000	Green (RoHS & no Sb/Br)	CU NIPDAU	Level-1-260C-UNLIM	
TPS3123G15DBVRG4	ACTIVE	SOT-23	DBV	5	3000	Green (RoHS & no Sb/Br)	CU NIPDAU	Level-1-260C-UNLIM	
TPS3123J12DBVR	ACTIVE	SOT-23	DBV	5	3000	Green (RoHS & no Sb/Br)	CU NIPDAU	Level-1-260C-UNLIM	
TPS3123J12DBVRG4	ACTIVE	SOT-23	DBV	5	3000	Green (RoHS & no Sb/Br)	CU NIPDAU	Level-1-260C-UNLIM	
TPS3123J12DBVT	ACTIVE	SOT-23	DBV	5	250	Green (RoHS & no Sb/Br)	CU NIPDAU	Level-1-260C-UNLIM	
TPS3123J12DBVTG4	ACTIVE	SOT-23	DBV	5	250	Green (RoHS & no Sb/Br)	CU NIPDAU	Level-1-260C-UNLIM	
TPS3123J18DBVR	ACTIVE	SOT-23	DBV	5	3000	Green (RoHS & no Sb/Br)	CU NIPDAU	Level-1-260C-UNLIM	
TPS3123J18DBVRG4	ACTIVE	SOT-23	DBV	5	3000	Green (RoHS & no Sb/Br)	CU NIPDAU	Level-1-260C-UNLIM	
TPS3123J18DBVT	ACTIVE	SOT-23	DBV	5	250	Green (RoHS & no Sb/Br)	CU NIPDAU	Level-1-260C-UNLIM	
TPS3123J18DBVTG4	ACTIVE	SOT-23	DBV	5	250	Green (RoHS & no Sb/Br)	CU NIPDAU	Level-1-260C-UNLIM	
TPS3124G15DBVR	ACTIVE	SOT-23	DBV	5	3000	Green (RoHS & no Sb/Br)	CU NIPDAU	Level-1-260C-UNLIM	
TPS3124G15DBVRG4	ACTIVE	SOT-23	DBV	5	3000	Green (RoHS & no Sb/Br)	CU NIPDAU	Level-1-260C-UNLIM	
TPS3124J12DBVR	ACTIVE	SOT-23	DBV	5	3000	Green (RoHS & no Sb/Br)	CU NIPDAU	Level-1-260C-UNLIM	
TPS3124J12DBVRG4	ACTIVE	SOT-23	DBV	5	3000	Green (RoHS & no Sb/Br)	CU NIPDAU	Level-1-260C-UNLIM	
TPS3124J12DBVT	ACTIVE	SOT-23	DBV	5	250	Green (RoHS & no Sb/Br)	CU NIPDAU	Level-1-260C-UNLIM	
TPS3124J12DBVTG4	ACTIVE	SOT-23	DBV	5	250	Green (RoHS & no Sb/Br)	CU NIPDAU	Level-1-260C-UNLIM	
TPS3124J18DBVR	ACTIVE	SOT-23	DBV	5	3000	Green (RoHS & no Sb/Br)	CU NIPDAU	Level-1-260C-UNLIM	

Orderable Device	Status ⁽¹⁾	Package Type	Package Drawing	Pins	Package Qty	Eco Plan ⁽²⁾	Lead/ Ball Finish	MSL Peak Temp ⁽³⁾	Samples (Requires Login)
TPS3124J18DBVRG4	ACTIVE	SOT-23	DBV	5	3000	Green (RoHS & no Sb/Br)	CU NIPDAU	Level-1-260C-UNLIM	
TPS3124J18DBVT	ACTIVE	SOT-23	DBV	5	250	Green (RoHS & no Sb/Br)	CU NIPDAU	Level-1-260C-UNLIM	
TPS3124J18DBVTG4	ACTIVE	SOT-23	DBV	5	250	Green (RoHS & no Sb/Br)	CU NIPDAU	Level-1-260C-UNLIM	
TPS3125G15DBVR	ACTIVE	SOT-23	DBV	5	3000	Green (RoHS & no Sb/Br)	CU NIPDAU	Level-1-260C-UNLIM	
TPS3125G15DBVRG4	ACTIVE	SOT-23	DBV	5	3000	Green (RoHS & no Sb/Br)	CU NIPDAU	Level-1-260C-UNLIM	
TPS3125G15DBVT	ACTIVE	SOT-23	DBV	5	250	Green (RoHS & no Sb/Br)	CU NIPDAU	Level-1-260C-UNLIM	
TPS3125G15DBVTG4	ACTIVE	SOT-23	DBV	5	250	Green (RoHS & no Sb/Br)	CU NIPDAU	Level-1-260C-UNLIM	
TPS3125J12DBVR	ACTIVE	SOT-23	DBV	5	3000	Green (RoHS & no Sb/Br)	CU NIPDAU	Level-1-260C-UNLIM	
TPS3125J12DBVRG4	ACTIVE	SOT-23	DBV	5	3000	Green (RoHS & no Sb/Br)	CU NIPDAU	Level-1-260C-UNLIM	
TPS3125J12DBVT	ACTIVE	SOT-23	DBV	5	250	Green (RoHS & no Sb/Br)	CU NIPDAU	Level-1-260C-UNLIM	
TPS3125J12DBVTG4	ACTIVE	SOT-23	DBV	5	250	Green (RoHS & no Sb/Br)	CU NIPDAU	Level-1-260C-UNLIM	
TPS3125J18DBVR	ACTIVE	SOT-23	DBV	5	3000	Green (RoHS & no Sb/Br)	CU NIPDAU	Level-1-260C-UNLIM	
TPS3125J18DBVRG4	ACTIVE	SOT-23	DBV	5	3000	Green (RoHS & no Sb/Br)	CU NIPDAU	Level-1-260C-UNLIM	
TPS3125J18DBVT	ACTIVE	SOT-23	DBV	5	250	Green (RoHS & no Sb/Br)	CU NIPDAU	Level-1-260C-UNLIM	
TPS3125J18DBVTG4	ACTIVE	SOT-23	DBV	5	250	Green (RoHS & no Sb/Br)	CU NIPDAU	Level-1-260C-UNLIM	
TPS3125L30DBVR	ACTIVE	SOT-23	DBV	5	3000	Green (RoHS & no Sb/Br)	CU NIPDAU	Level-1-260C-UNLIM	
TPS3125L30DBVRG4	ACTIVE	SOT-23	DBV	5	3000	Green (RoHS & no Sb/Br)	CU NIPDAU	Level-1-260C-UNLIM	
TPS3125L30DBVT	ACTIVE	SOT-23	DBV	5	250	Green (RoHS & no Sb/Br)	CU NIPDAU	Level-1-260C-UNLIM	

Orderable Device	Status ⁽¹⁾	Package Type	Package Drawing	Pins	Package Qty	Eco Plan ⁽²⁾	Lead/ Ball Finish	MSL Peak Temp ⁽³⁾	Samples (Requires Login)
TPS3125L30DBVTG4	ACTIVE	SOT-23	DBV	5	250	Green (RoHS & no Sb/Br)	CU NIPDAU	Level-1-260C-UNLIM	
TPS3126E12DBVR	ACTIVE	SOT-23	DBV	5	3000	Green (RoHS & no Sb/Br)	CU NIPDAU	Level-1-260C-UNLIM	
TPS3126E12DBVRG4	ACTIVE	SOT-23	DBV	5	3000	Green (RoHS & no Sb/Br)	CU NIPDAU	Level-1-260C-UNLIM	
TPS3126E12DBVT	ACTIVE	SOT-23	DBV	5	250	Green (RoHS & no Sb/Br)	CU NIPDAU	Level-1-260C-UNLIM	
TPS3126E12DBVTG4	ACTIVE	SOT-23	DBV	5	250	Green (RoHS & no Sb/Br)	CU NIPDAU	Level-1-260C-UNLIM	
TPS3126E15DBVR	ACTIVE	SOT-23	DBV	5	3000	Green (RoHS & no Sb/Br)	CU NIPDAU	Level-1-260C-UNLIM	
TPS3126E15DBVRG4	ACTIVE	SOT-23	DBV	5	3000	Green (RoHS & no Sb/Br)	CU NIPDAU	Level-1-260C-UNLIM	
TPS3126E15DBVT	ACTIVE	SOT-23	DBV	5	250	Green (RoHS & no Sb/Br)	CU NIPDAU	Level-1-260C-UNLIM	
TPS3126E15DBVTG4	ACTIVE	SOT-23	DBV	5	250	Green (RoHS & no Sb/Br)	CU NIPDAU	Level-1-260C-UNLIM	
TPS3126E18DBVR	ACTIVE	SOT-23	DBV	5	3000	Green (RoHS & no Sb/Br)	CU NIPDAU	Level-1-260C-UNLIM	
TPS3126E18DBVRG4	ACTIVE	SOT-23	DBV	5	3000	Green (RoHS & no Sb/Br)	CU NIPDAU	Level-1-260C-UNLIM	
TPS3126E18DBVT	ACTIVE	SOT-23	DBV	5	250	Green (RoHS & no Sb/Br)	CU NIPDAU	Level-1-260C-UNLIM	
TPS3126E18DBVTG4	ACTIVE	SOT-23	DBV	5	250	Green (RoHS & no Sb/Br)	CU NIPDAU	Level-1-260C-UNLIM	
TPS3128E12DBVT	ACTIVE	SOT-23	DBV	5	250	Green (RoHS & no Sb/Br)	CU NIPDAU	Level-1-260C-UNLIM	
TPS3128E12DBVTG4	ACTIVE	SOT-23	DBV	5	250	Green (RoHS & no Sb/Br)	CU NIPDAU	Level-1-260C-UNLIM	
TPS3128E15DBVR	ACTIVE	SOT-23	DBV	5	3000	Green (RoHS & no Sb/Br)	CU NIPDAU	Level-1-260C-UNLIM	
TPS3128E15DBVRG4	ACTIVE	SOT-23	DBV	5	3000	Green (RoHS & no Sb/Br)	CU NIPDAU	Level-1-260C-UNLIM	
TPS3128E15DBVT	ACTIVE	SOT-23	DBV	5	250	Green (RoHS & no Sb/Br)	CU NIPDAU	Level-1-260C-UNLIM	

Orderable Device	Status ⁽¹⁾	Package Type	Package Drawing	Pins	Package Qty	Eco Plan ⁽²⁾	Lead/ Ball Finish	MSL Peak Temp ⁽³⁾	Samples (Requires Login)
TPS3128E15DBVTG4	ACTIVE	SOT-23	DBV	5	250	Green (RoHS & no Sb/Br)	CU NIPDAU	Level-1-260C-UNLIM	
TPS3128E18DBVR	ACTIVE	SOT-23	DBV	5	3000	Green (RoHS & no Sb/Br)	CU NIPDAU	Level-1-260C-UNLIM	
TPS3128E18DBVRG4	ACTIVE	SOT-23	DBV	5	3000	Green (RoHS & no Sb/Br)	CU NIPDAU	Level-1-260C-UNLIM	
TPS3128E18DBVT	ACTIVE	SOT-23	DBV	5	250	Green (RoHS & no Sb/Br)	CU NIPDAU	Level-1-260C-UNLIM	
TPS3128E18DBVTG4	ACTIVE	SOT-23	DBV	5	250	Green (RoHS & no Sb/Br)	CU NIPDAU	Level-1-260C-UNLIM	

⁽¹⁾ The marketing status values are defined as follows:

ACTIVE: Product device recommended for new designs.

LIFEBUY: TI has announced that the device will be discontinued, and a lifetime-buy period is in effect.

NRND: Not recommended for new designs. Device is in production to support existing customers, but TI does not recommend using this part in a new design.

PREVIEW: Device has been announced but is not in production. Samples may or may not be available.

OBSOLETE: TI has discontinued the production of the device.

⁽²⁾ Eco Plan - The planned eco-friendly classification: Pb-Free (RoHS), Pb-Free (RoHS Exempt), or Green (RoHS & no Sb/Br) - please check <http://www.ti.com/productcontent> for the latest availability information and additional product content details.

TBD: The Pb-Free/Green conversion plan has not been defined.

Pb-Free (RoHS): TI's terms "Lead-Free" or "Pb-Free" mean semiconductor products that are compatible with the current RoHS requirements for all 6 substances, including the requirement that lead not exceed 0.1% by weight in homogeneous materials. Where designed to be soldered at high temperatures, TI Pb-Free products are suitable for use in specified lead-free processes.

Pb-Free (RoHS Exempt): This component has a RoHS exemption for either 1) lead-based flip-chip solder bumps used between the die and package, or 2) lead-based die adhesive used between the die and leadframe. The component is otherwise considered Pb-Free (RoHS compatible) as defined above.

Green (RoHS & no Sb/Br): TI defines "Green" to mean Pb-Free (RoHS compatible), and free of Bromine (Br) and Antimony (Sb) based flame retardants (Br or Sb do not exceed 0.1% by weight in homogeneous material)

⁽³⁾ MSL, Peak Temp. -- The Moisture Sensitivity Level rating according to the JEDEC industry standard classifications, and peak solder temperature.

Important Information and Disclaimer: The information provided on this page represents TI's knowledge and belief as of the date that it is provided. TI bases its knowledge and belief on information provided by third parties, and makes no representation or warranty as to the accuracy of such information. Efforts are underway to better integrate information from third parties. TI has taken and continues to take reasonable steps to provide representative and accurate information but may not have conducted destructive testing or chemical analysis on incoming materials and chemicals. TI and TI suppliers consider certain information to be proprietary, and thus CAS numbers and other limited information may not be available for release.

In no event shall TI's liability arising out of such information exceed the total purchase price of the TI part(s) at issue in this document sold by TI to Customer on an annual basis.

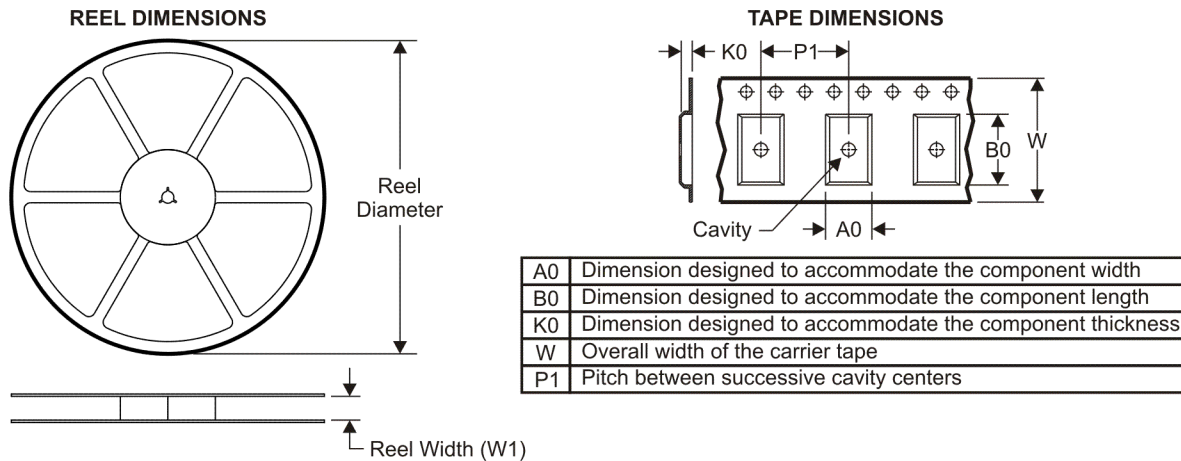
TAPE AND REEL INFORMATION

QUADRANT ASSIGNMENTS FOR PIN 1 ORIENTATION IN TAPE

*All dimensions are nominal

Device	Package Type	Package Drawing	Pins	SPQ	Reel Diameter (mm)	Reel Width W1 (mm)	A0 (mm)	B0 (mm)	K0 (mm)	P1 (mm)	W (mm)	Pin1 Quadrant
TPS3123G15DBVR	SOT-23	DBV	5	3000	180.0	9.0	3.15	3.2	1.4	4.0	8.0	Q3
TPS3123J12DBVR	SOT-23	DBV	5	3000	180.0	9.0	3.15	3.2	1.4	4.0	8.0	Q3
TPS3123J12DBVT	SOT-23	DBV	5	250	180.0	9.0	3.15	3.2	1.4	4.0	8.0	Q3
TPS3123J18DBVR	SOT-23	DBV	5	3000	180.0	9.0	3.15	3.2	1.4	4.0	8.0	Q3
TPS3123J18DBVT	SOT-23	DBV	5	250	180.0	9.0	3.15	3.2	1.4	4.0	8.0	Q3
TPS3124G15DBVR	SOT-23	DBV	5	3000	180.0	9.0	3.15	3.2	1.4	4.0	8.0	Q3
TPS3124J12DBVR	SOT-23	DBV	5	3000	180.0	9.0	3.15	3.2	1.4	4.0	8.0	Q3
TPS3124J12DBVT	SOT-23	DBV	5	250	180.0	9.0	3.15	3.2	1.4	4.0	8.0	Q3
TPS3124J18DBVR	SOT-23	DBV	5	3000	180.0	9.0	3.15	3.2	1.4	4.0	8.0	Q3
TPS3124J18DBVT	SOT-23	DBV	5	250	180.0	9.0	3.15	3.2	1.4	4.0	8.0	Q3
TPS3125G15DBVR	SOT-23	DBV	5	3000	180.0	9.0	3.15	3.2	1.4	4.0	8.0	Q3
TPS3125G15DBVT	SOT-23	DBV	5	250	180.0	9.0	3.15	3.2	1.4	4.0	8.0	Q3
TPS3125J12DBVR	SOT-23	DBV	5	3000	180.0	9.0	3.15	3.2	1.4	4.0	8.0	Q3
TPS3125J12DBVT	SOT-23	DBV	5	250	180.0	9.0	3.15	3.2	1.4	4.0	8.0	Q3
TPS3125J18DBVR	SOT-23	DBV	5	3000	180.0	9.0	3.15	3.2	1.4	4.0	8.0	Q3
TPS3125J18DBVT	SOT-23	DBV	5	250	180.0	9.0	3.15	3.2	1.4	4.0	8.0	Q3
TPS3125L30DBVR	SOT-23	DBV	5	3000	180.0	9.0	3.15	3.2	1.4	4.0	8.0	Q3
TPS3125L30DBVT	SOT-23	DBV	5	250	180.0	9.0	3.15	3.2	1.4	4.0	8.0	Q3

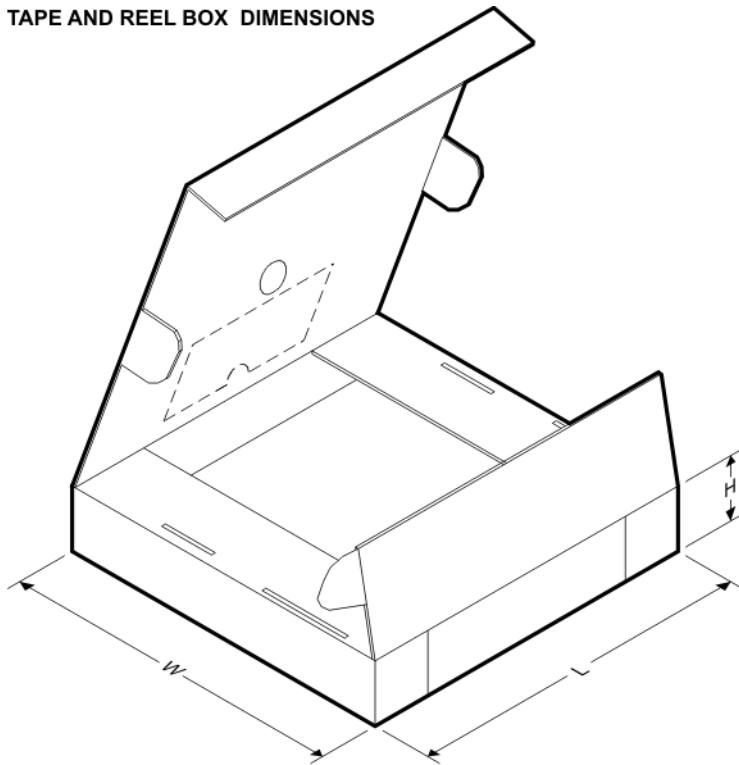
Device	Package Type	Package Drawing	Pins	SPQ	Reel Diameter (mm)	Reel Width W1 (mm)	A0 (mm)	B0 (mm)	K0 (mm)	P1 (mm)	W (mm)	Pin1 Quadrant
TPS3126E12DBVR	SOT-23	DBV	5	3000	180.0	9.0	3.15	3.2	1.4	4.0	8.0	Q3
TPS3126E12DBVT	SOT-23	DBV	5	250	180.0	9.0	3.15	3.2	1.4	4.0	8.0	Q3
TPS3126E15DBVR	SOT-23	DBV	5	3000	180.0	9.0	3.15	3.2	1.4	4.0	8.0	Q3
TPS3126E15DBVT	SOT-23	DBV	5	250	180.0	9.0	3.15	3.2	1.4	4.0	8.0	Q3
TPS3126E18DBVR	SOT-23	DBV	5	3000	180.0	9.0	3.15	3.2	1.4	4.0	8.0	Q3
TPS3126E18DBVT	SOT-23	DBV	5	250	180.0	9.0	3.15	3.2	1.4	4.0	8.0	Q3
TPS3128E12DBVT	SOT-23	DBV	5	250	180.0	9.0	3.15	3.2	1.4	4.0	8.0	Q3
TPS3128E15DBVR	SOT-23	DBV	5	3000	180.0	9.0	3.15	3.2	1.4	4.0	8.0	Q3
TPS3128E15DBVT	SOT-23	DBV	5	250	180.0	9.0	3.15	3.2	1.4	4.0	8.0	Q3
TPS3128E18DBVR	SOT-23	DBV	5	3000	180.0	9.0	3.15	3.2	1.4	4.0	8.0	Q3
TPS3128E18DBVT	SOT-23	DBV	5	250	180.0	9.0	3.15	3.2	1.4	4.0	8.0	Q3

TAPE AND REEL BOX DIMENSIONS

*All dimensions are nominal

Device	Package Type	Package Drawing	Pins	SPQ	Length (mm)	Width (mm)	Height (mm)
TPS3123G15DBVR	SOT-23	DBV	5	3000	182.0	182.0	20.0
TPS3123J12DBVR	SOT-23	DBV	5	3000	182.0	182.0	20.0
TPS3123J12DBVT	SOT-23	DBV	5	250	182.0	182.0	20.0
TPS3123J18DBVR	SOT-23	DBV	5	3000	182.0	182.0	20.0
TPS3123J18DBVT	SOT-23	DBV	5	250	182.0	182.0	20.0
TPS3124G15DBVR	SOT-23	DBV	5	3000	182.0	182.0	20.0

Device	Package Type	Package Drawing	Pins	SPQ	Length (mm)	Width (mm)	Height (mm)
TPS3124J12DBVR	SOT-23	DBV	5	3000	182.0	182.0	20.0
TPS3124J12DBVT	SOT-23	DBV	5	250	182.0	182.0	20.0
TPS3124J18DBVR	SOT-23	DBV	5	3000	182.0	182.0	20.0
TPS3124J18DBVT	SOT-23	DBV	5	250	182.0	182.0	20.0
TPS3125G15DBVR	SOT-23	DBV	5	3000	182.0	182.0	20.0
TPS3125G15DBVT	SOT-23	DBV	5	250	182.0	182.0	20.0
TPS3125J12DBVR	SOT-23	DBV	5	3000	182.0	182.0	20.0
TPS3125J12DBVT	SOT-23	DBV	5	250	182.0	182.0	20.0
TPS3125J18DBVR	SOT-23	DBV	5	3000	182.0	182.0	20.0
TPS3125J18DBVT	SOT-23	DBV	5	250	182.0	182.0	20.0
TPS3125L30DBVR	SOT-23	DBV	5	3000	182.0	182.0	20.0
TPS3125L30DBVT	SOT-23	DBV	5	250	182.0	182.0	20.0
TPS3126E12DBVR	SOT-23	DBV	5	3000	182.0	182.0	20.0
TPS3126E12DBVT	SOT-23	DBV	5	250	182.0	182.0	20.0
TPS3126E15DBVR	SOT-23	DBV	5	3000	182.0	182.0	20.0
TPS3126E15DBVT	SOT-23	DBV	5	250	182.0	182.0	20.0
TPS3126E18DBVR	SOT-23	DBV	5	3000	182.0	182.0	20.0
TPS3126E18DBVT	SOT-23	DBV	5	250	182.0	182.0	20.0
TPS3128E12DBVT	SOT-23	DBV	5	250	182.0	182.0	20.0
TPS3128E15DBVR	SOT-23	DBV	5	3000	182.0	182.0	20.0
TPS3128E15DBVT	SOT-23	DBV	5	250	182.0	182.0	20.0
TPS3128E18DBVR	SOT-23	DBV	5	3000	182.0	182.0	20.0
TPS3128E18DBVT	SOT-23	DBV	5	250	182.0	182.0	20.0

DBV (R-PDSO-G5)

PLASTIC SMALL OUTLINE



- NOTES:
- A. All linear dimensions are in millimeters.
 - B. This drawing is subject to change without notice.
 - C. Customers should place a note on the circuit board fabrication drawing not to alter the center solder mask defined pad.
 - D. Publication IPC-7351 is recommended for alternate designs.
 - E. Laser cutting apertures with trapezoidal walls and also rounding corners will offer better paste release. Customers should contact their board assembly site for stencil design recommendations. Example stencil design based on a 50% volumetric metal load solder paste. Refer to IPC-7525 for other stencil recommendations.

IMPORTANT NOTICE

Texas Instruments Incorporated and its subsidiaries (TI) reserve the right to make corrections, modifications, enhancements, improvements, and other changes to its products and services at any time and to discontinue any product or service without notice. Customers should obtain the latest relevant information before placing orders and should verify that such information is current and complete. All products are sold subject to TI's terms and conditions of sale supplied at the time of order acknowledgment.

TI warrants performance of its hardware products to the specifications applicable at the time of sale in accordance with TI's standard warranty. Testing and other quality control techniques are used to the extent TI deems necessary to support this warranty. Except where mandated by government requirements, testing of all parameters of each product is not necessarily performed.

TI assumes no liability for applications assistance or customer product design. Customers are responsible for their products and applications using TI components. To minimize the risks associated with customer products and applications, customers should provide adequate design and operating safeguards.

TI does not warrant or represent that any license, either express or implied, is granted under any TI patent right, copyright, mask work right, or other TI intellectual property right relating to any combination, machine, or process in which TI products or services are used. Information published by TI regarding third-party products or services does not constitute a license from TI to use such products or services or a warranty or endorsement thereof. Use of such information may require a license from a third party under the patents or other intellectual property of the third party, or a license from TI under the patents or other intellectual property of TI.

Reproduction of TI information in TI data books or data sheets is permissible only if reproduction is without alteration and is accompanied by all associated warranties, conditions, limitations, and notices. Reproduction of this information with alteration is an unfair and deceptive business practice. TI is not responsible or liable for such altered documentation. Information of third parties may be subject to additional restrictions.

Resale of TI products or services with statements different from or beyond the parameters stated by TI for that product or service voids all express and any implied warranties for the associated TI product or service and is an unfair and deceptive business practice. TI is not responsible or liable for any such statements.

TI products are not authorized for use in safety-critical applications (such as life support) where a failure of the TI product would reasonably be expected to cause severe personal injury or death, unless officers of the parties have executed an agreement specifically governing such use. Buyers represent that they have all necessary expertise in the safety and regulatory ramifications of their applications, and acknowledge and agree that they are solely responsible for all legal, regulatory and safety-related requirements concerning their products and any use of TI products in such safety-critical applications, notwithstanding any applications-related information or support that may be provided by TI. Further, Buyers must fully indemnify TI and its representatives against any damages arising out of the use of TI products in such safety-critical applications.

TI products are neither designed nor intended for use in military/aerospace applications or environments unless the TI products are specifically designated by TI as military-grade or "enhanced plastic." Only products designated by TI as military-grade meet military specifications. Buyers acknowledge and agree that any such use of TI products which TI has not designated as military-grade is solely at the Buyer's risk, and that they are solely responsible for compliance with all legal and regulatory requirements in connection with such use.

TI products are neither designed nor intended for use in automotive applications or environments unless the specific TI products are designated by TI as compliant with ISO/TS 16949 requirements. Buyers acknowledge and agree that, if they use any non-designated products in automotive applications, TI will not be responsible for any failure to meet such requirements.

Following are URLs where you can obtain information on other Texas Instruments products and application solutions:

Products

Audio	www.ti.com/audio
Amplifiers	amplifier.ti.com
Data Converters	dataconverter.ti.com
DLP® Products	www.dlp.com
DSP	dsp.ti.com
Clocks and Timers	www.ti.com/clocks
Interface	interface.ti.com
Logic	logic.ti.com
Power Mgmt	power.ti.com
Microcontrollers	microcontroller.ti.com
RFID	www.ti-rfid.com
OMAP Mobile Processors	www.ti.com/omap
Wireless Connectivity	www.ti.com/wirelessconnectivity

Applications

Communications and Telecom	www.ti.com/communications
Computers and Peripherals	www.ti.com/computers
Consumer Electronics	www.ti.com/consumer-apps
Energy and Lighting	www.ti.com/energy
Industrial	www.ti.com/industrial
Medical	www.ti.com/medical
Security	www.ti.com/security
Space, Avionics and Defense	www.ti.com/space-avionics-defense
Transportation and Automotive	www.ti.com/automotive
Video and Imaging	www.ti.com/video

TI E2E Community Home Page

e2e.ti.com

Mailing Address: Texas Instruments, Post Office Box 655303, Dallas, Texas 75265
Copyright © 2011, Texas Instruments Incorporated