

2, 4-CHANNEL PROTECTION SOLUTION FOR SUPER-SPEED (6 GBPS) USB 3.0 INTERFACE

Check for Samples: [TPD2EUSB30](#), [TPD2EUSB30A](#), [TPD4EUSB30](#)

FEATURES

- **Single and Dual-Pair Differential Lines to Protect the Differential Data and Clock Lines of the USB3.0, eSATA, or LVD Interface**
- **Flow-Through Pin Mapping for the High-Speed Lines Ensures near Zero Additional Skew Due to Board Layout While Placing Protection Chip Near the Connector**
- **Supports Data Rates in Excess of 6 Gbps**
- **ESD Protection Meets or Exceeds IEC61000-4-2 (Level 4)**
- **Low Capacitance 0.05pF (IO to IO)**
- **0.6 Ω Dynamic Resistance**
- **5-A Peak Pulse Current (per 8/20 μ s Pulse)**
- **Industrial Temperature Range: -40°C to 85°C**
- **Space-Saving DRT, DQA Packages**

APPLICATIONS

- **Notebooks**
- **Set-Top Boxes**
- **DVD Players**
- **Media Players**
- **Portable Computers**

DESCRIPTION/ORDERING INFORMATION

The TPD2EUSB30, TPD2EUSB30A, and TPD4EUSB30 provide 2 and 4 channel ESD and surge protection solutions in space saving, flow-through packages. These devices have been designed to protect sensitive components which are connected to ultra high-speed data and transmission lines. These devices also offer 5 A (8/20 μ s) peak pulse current ratings per IEC 61000-4-5 (lightning) specification.

The monolithic silicon technology allows matching between the differential signal pairs. The differential 0.05-pF capacitance ensures that the signal distortion due to added ESD clamp remains minimal at high-speed differential data transmission.

The TPD2EUSB30A offers low 4.5V dc break-down voltage. The low capacitance and break-down voltage, coupled low dynamic resistance, make the TPD2EUSB30A a superior ESD/ surge protection device for high-speed differential IOs based off ultra-low voltage process nodes.

The TPD2EUSB30 and TPD2EUSB30A are offered in space saving DRT (1 mm \times 1 mm) package. The TPD4EUSB30 is offered in space saving DQA (1 mm \times 2.5 mm) package. These devices are characterized for operation over ambient air temperature range of -40°C to 85°C .

**DRT PACKAGE
(TOP VIEW)**

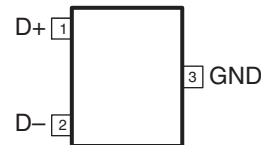

**DQA PACKAGE
(TOP VIEW)**

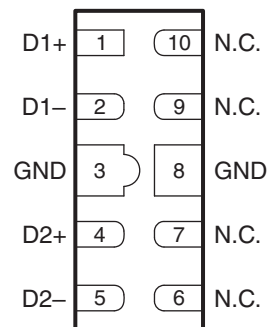

Please be aware that an important notice concerning availability, standard warranty, and use in critical applications of Texas Instruments semiconductor products and disclaimers thereto appears at the end of this data sheet.

ORDERING INFORMATION

T _A	PACKAGE ⁽¹⁾ ⁽²⁾		ORDERABLE PART NUMBER	TOP-SIDE MARKING ⁽³⁾
-40°C to 85°C	SOT – DRT	Tape and reel	TPD2EUSB30DRTR	5P
	SOT – DRT	Tape and reel	TPD2EUSB30ADRTR	5S
	SON – DQA	Tape and reel	TPD4EUSB30DQAR	66_

- (1) Package drawings, thermal data, and symbolization are available at www.ti.com/packaging.
- (2) For the most current package and ordering information, see the Package Option Addendum at the end of this document, or see the TI website at www.ti.com.
- (3) DQA: The actual top-side marking has one additional character that designates wafer fab/assembly site.

CIRCUIT DIAGRAMS

Figure 1. TPD4EUSB30 Circuit

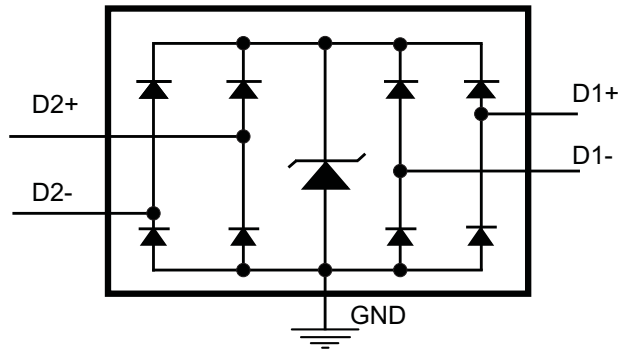
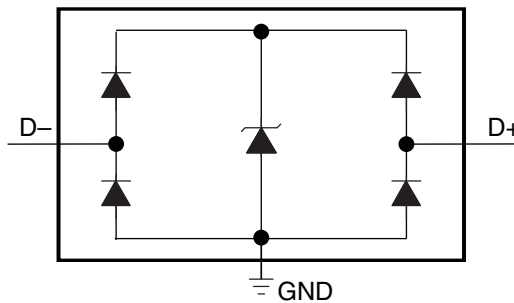

Figure 2. TPD2EUSB30/A Circuit



TERMINAL FUNCTIONS

NAME	TERMINAL		TYPE	DESCRIPTION
	DRT PIN NO.	DQA PIN NO.		
Dx+, Dx-	1, 2	1,2, 4, 5	ESD port	High-speed ESD clamp, provides ESD protection to the high-speed differential data lines
GND	3	3, 8	GND	Ground
N.C.		6, 7, 9, 10		Not normally connected

ABSOLUTE MAXIMUM RATINGS⁽¹⁾

over operating free-air temperature range (unless otherwise noted)

			MIN	MAX	UNIT
	IO voltage tolerance	D+, D– pins	0	6	
T _A	Operating free-air temperature range		–40	85	°C
T _{stg}	Storage temperature range		–65	125	°C
ESD protection	IEC 61000-4-2 Contact Discharge	D+, D– pins		±8	kV
	IEC 61000-4-2 Air-Gap Discharge (TPD2EUSB30/A)	D+, D– pins		±8	kV
	IEC 61000-4-2 Air-Gap Discharge (TPD4EUSB30)	D+, D– pins		±9	kV
	Peak pulse current (t _p = 8/20 μs)	D+, D– pins		5	A
	Peak pulse power (t _p = 8/20 μs)	D+, D– pins		45	W

- (1) Stresses beyond those listed under "absolute maximum ratings" may cause permanent damage to the device. These are stress ratings only, and functional operation of the device at these or any other conditions beyond those indicated in the operational sections of the specifications is not implied. Exposure to absolute maximum-rated conditions for extended periods may affect device reliability.

ELECTRICAL CHARACTERISTICS

over operating free-air temperature range (unless otherwise noted)

PARAMETER		TEST CONDITIONS		MIN	TYP	MAX	UNIT
V _{RWM}	Reverse stand-off voltage, TPD2EUSB30, TPD4EUSB30	D+, D– pins to ground				5.5	V
	Reverse stand-off voltage, TPD2EUSB30A	D+, D– pins to ground				3.6	V
V _{clamp}	Clamp voltage	D+, D– pins to ground, I _{IO} = 1 A				8	V
I _{IO}	Current from IO port to supply pins	V _{IO} = 2.5 V,	I _D = 8 mA		0.01	0.1	μA
V _D	Diode forward voltage	D+, D– pins, lower clamp diode,	V _{IO} = 2.5 V, I _D = 8 mA	0.6	0.8	0.95	V
R _{dyn}	Dynamic resistance	D+, D– pins I = 1 A			0.6		Ω
C _{IO-IO}	Capacitance IO to IO	D+, D– pins V _{IO} = 2.5 V			0.05		pF
C _{IO-GND}	Capacitance IO to GND	D+, D– pins (DRT)			0.7		pF
		D1+, D1-, D2+, D2- (DQA)		V _{IO} = 2.5 V	0.8		
V _{BR}	Break-down voltage, TPD2EUSB30, TPD4EUSB30	I _{IO} = 1 mA		7			V
	Break-down voltage, TPD2EUSB30A	I _{IO} = 1 mA		4.5			V

TYPICAL OPERATING CHARACTERISTICS

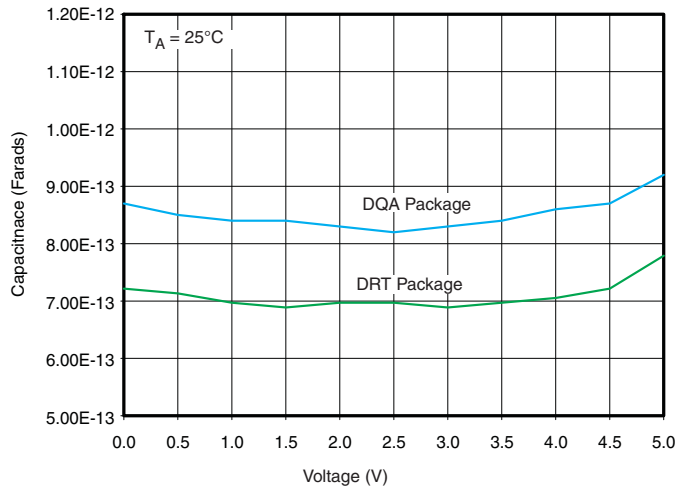

Figure 3. IO Capacitance vs IO Voltage

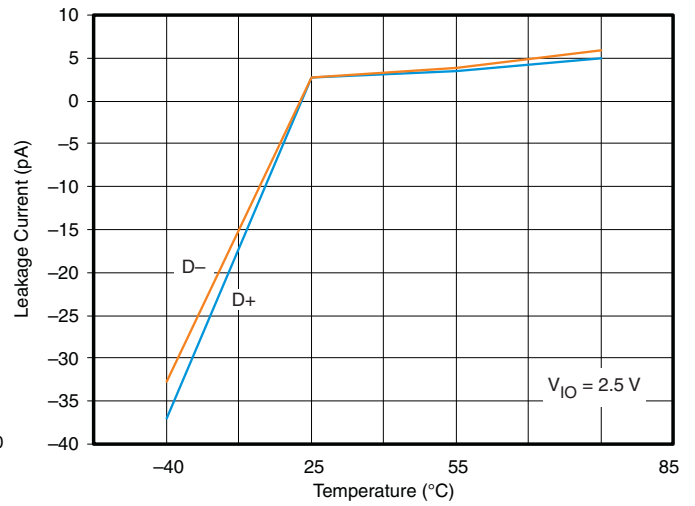

Figure 4. Leakage Current vs Temperature

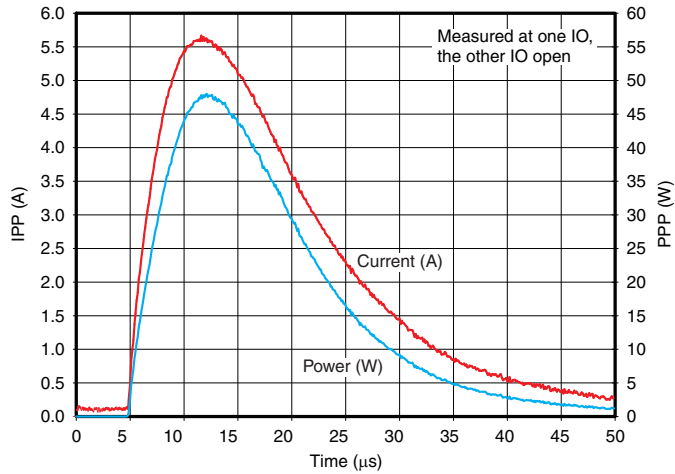

Figure 5. Peak Pulse Waveforms

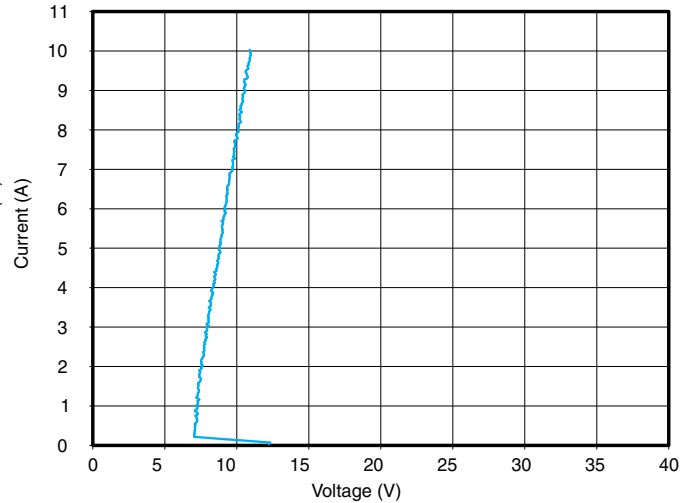

Figure 6. D+, D- Transmission Line Pulsar Plot for TPD2EUSB30 (100 ns Pulse, 10 ns Rise Time)

TYPICAL OPERATING CHARACTERISTICS (continued)

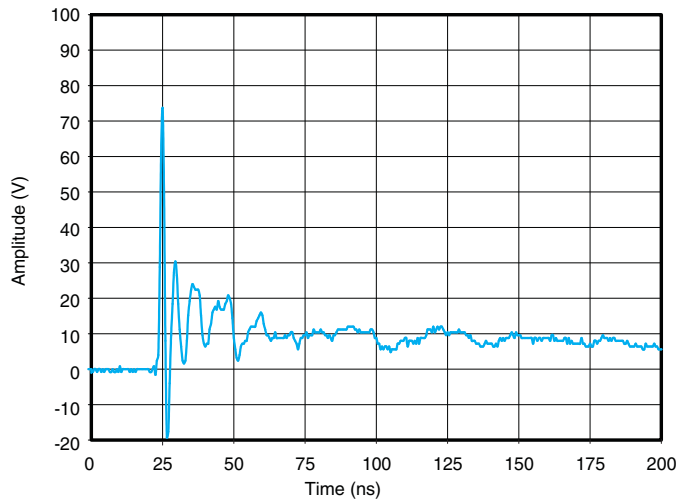

Figure 7. IEC Clamping Waveforms (8 kV Contact)

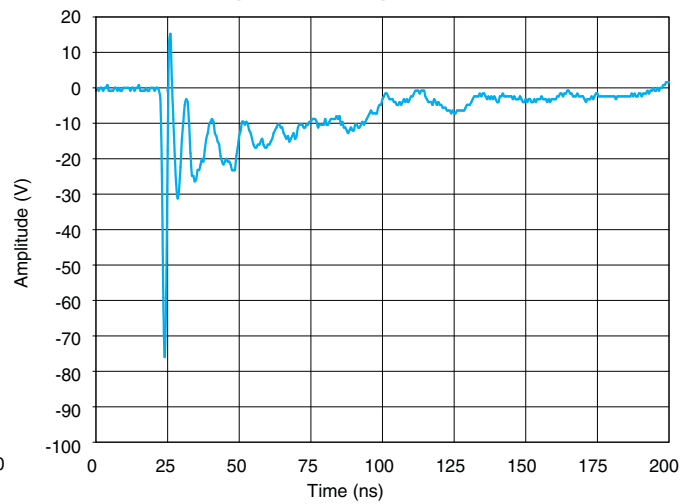

Figure 8. IEC Clamping Waveforms (-8 kV Contact)

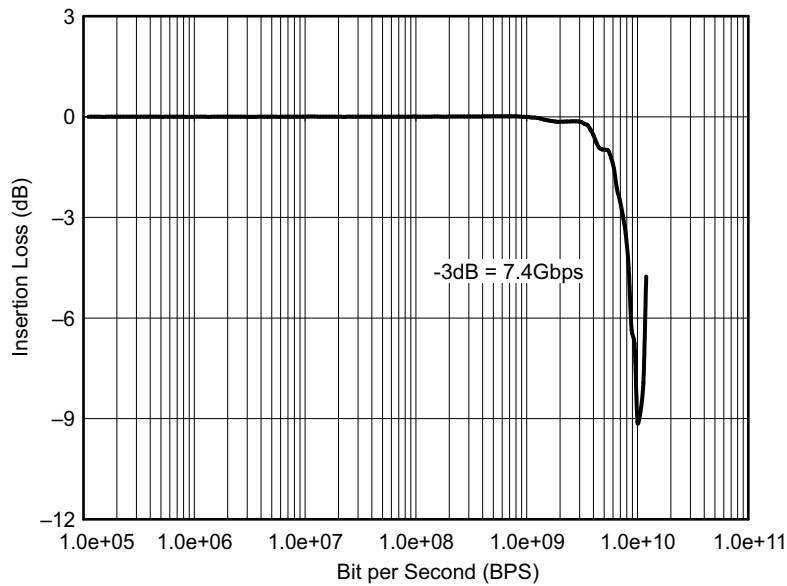

Figure 9. Insertion Loss

APPLICATION INFORMATION

Layout Guide with TPDxEUSB30/A

Refer to [Figure 10](#), the TPD2EUSB30/A are offered in space saving DRT package. The DRT is a 1mm* 1mm package with flow-through pin-mapping for the high-speed differential lines. The TPD4EUSB30 is offered in space saving DQA package. The DQA is a 1mm* 2.5mm package with flow-through pin-mapping for the high-speed differential lines. It is recommended to place the package right next to the USB 3.0 connector. The GND pin should be connected to GND plane of the board through a large VIA. If a dedicated GND plane is not present right underneath, it is recommended to route to the GND plane through a wide trace. The current associated with IEC ESD stress can be in the range of 30Amps or higher momentarily. A good, low impedance GND path ensures the system robustness against IEC ESD stress.

The TPDxEUSB30/A can provide system level ESD protection to the high-speed differential ports (>6 Gbps data rate). The flow-through package offers flexibility for board routing with traces up to 15 mills wide. It allows the differential signal pairs couple together right after they touch the ESD ports of the TPDxEUSB30/A.

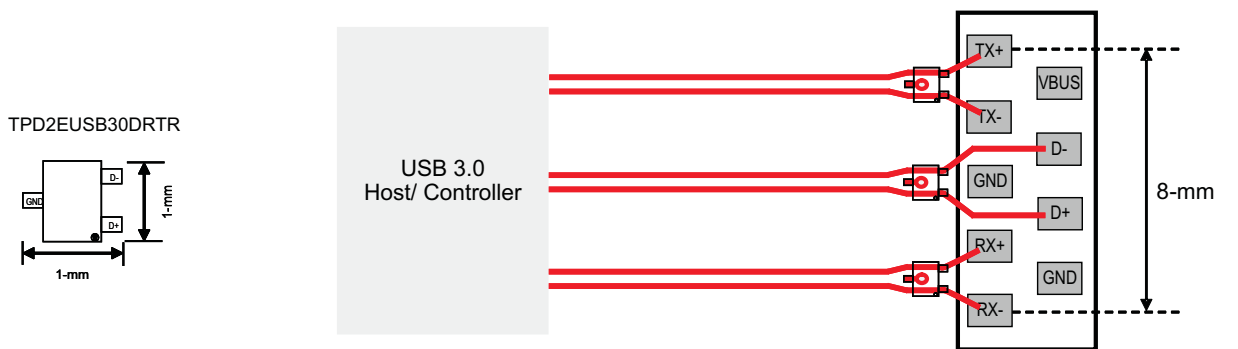

Three TPD2EUSB30 to Protect USB3.0 Class A connector (One Layer Routing)

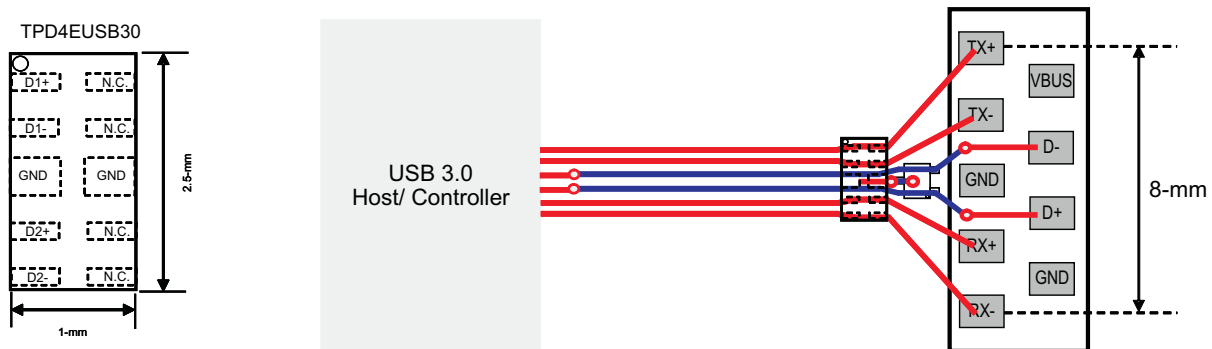

One TPD4EUSB30 & One TPD2EUSB30 to Protect USB3.0 Class A connector (Two Layer Routing)

Figure 10. Layout Guide with the TPDxEUSB30/A at the USB3.0 Class A Connector

TPDxEUSB30/A Eye Pattern Test

See [Figure 12](#) for a demonstration of the TPDxEUSB30/A performance the lab set-up. [Figure 11](#) shows a lab board that was designed to demonstrate the degradation of the eye pattern quality with and without the TPD2EUSB30/A in the USB 3.0 signal path. [Figure 13](#) shows that there is only ~2 ps jitter penalty to the differential signal when the TPD2EUSB30/A device was added in the signal path. Similar setup was employed to measure eye pattern for the TPD4EUSB30.

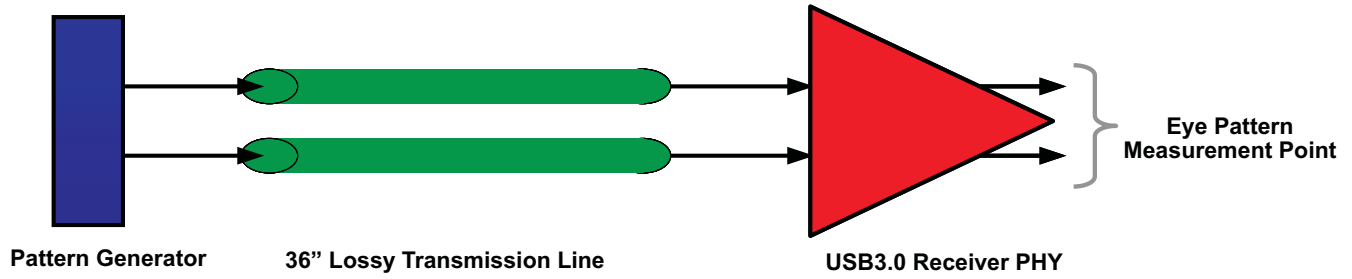

Figure 11. Measurement Setup to collect the Eye Pattern on a Reference Board with TPD2EUSB30/A

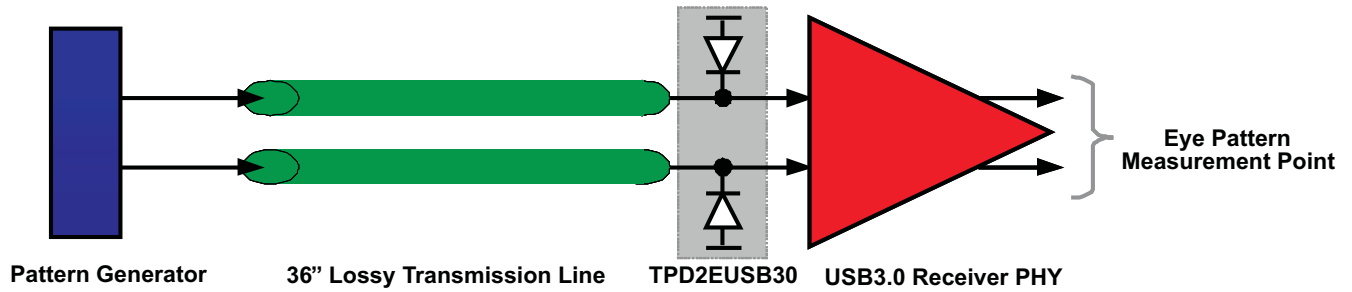

Figure 12. Measurement Setup to collect the Eye Pattern on a Reference Board with TPD2EUSB30/A

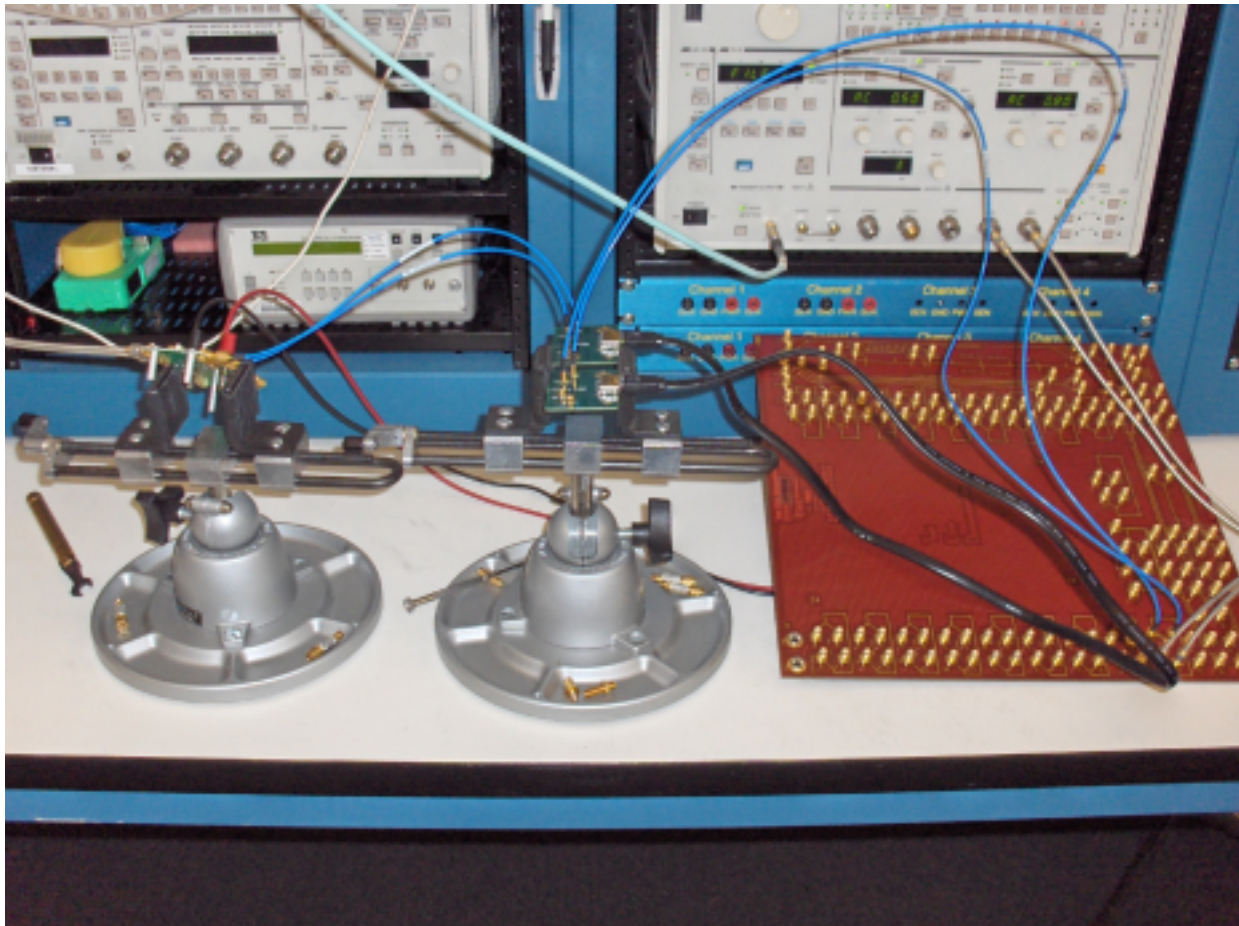

Figure 13. Lab Setup for the Eye-Pattern Measurement with TPDxUSB30/A

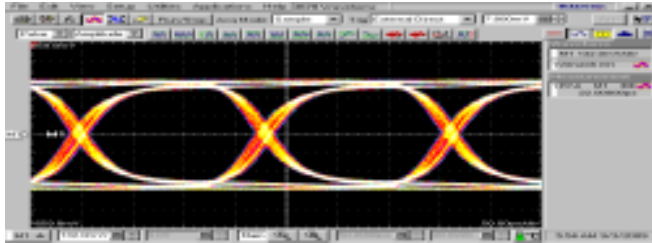

Figure 14. Output Eye Diagram Without TPD2EUSB30/A (Figure 11 Setup, 5 Gbps Data Rate)

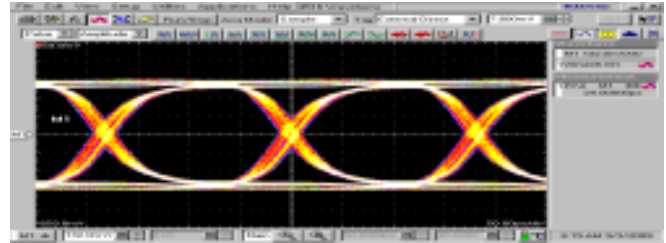

Figure 15. Output Eye Diagram with the TPD2EUSB30/A (Figure 11 Setup, 5 Gbps Data Rate)

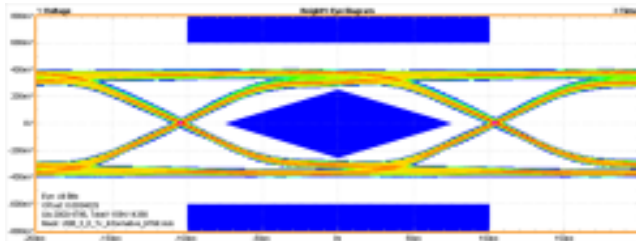

Figure 16. Output Eye Diagram Without the TPD4EUSB30 (5 Gbps Data Rate)

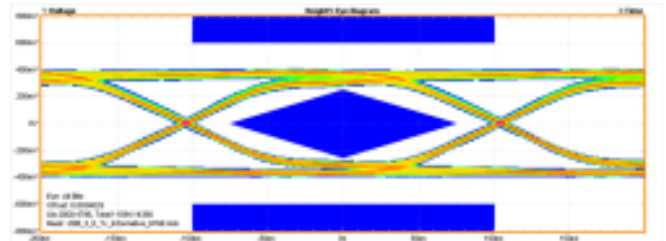

Figure 17. Output Eye Diagram with the TPD4EUSB30 (5 Gbps Data Rate)

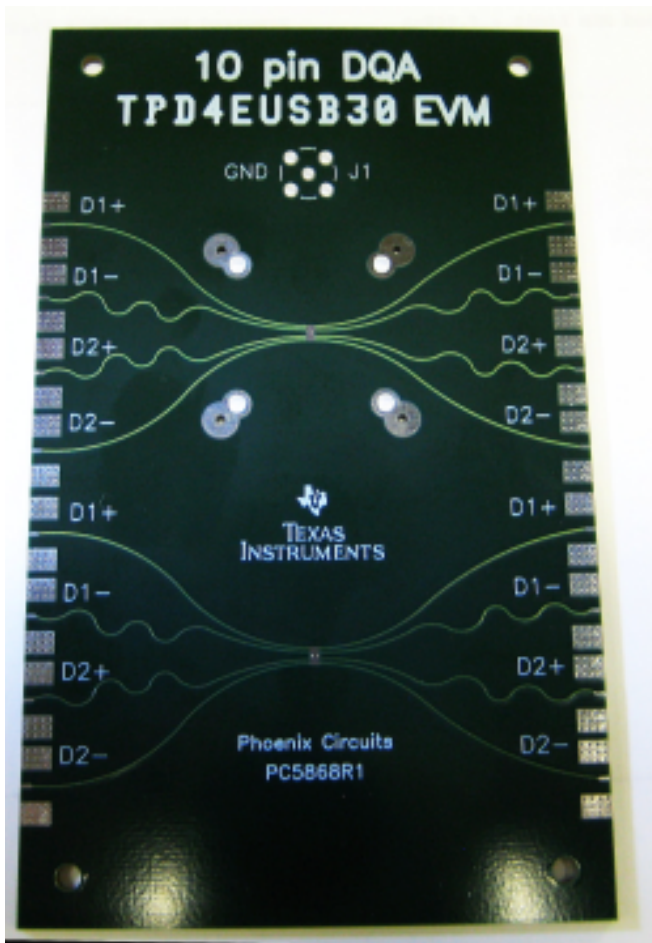

Figure 18. TPDxUSB30/A EVM – TPD4EUSB30 Side

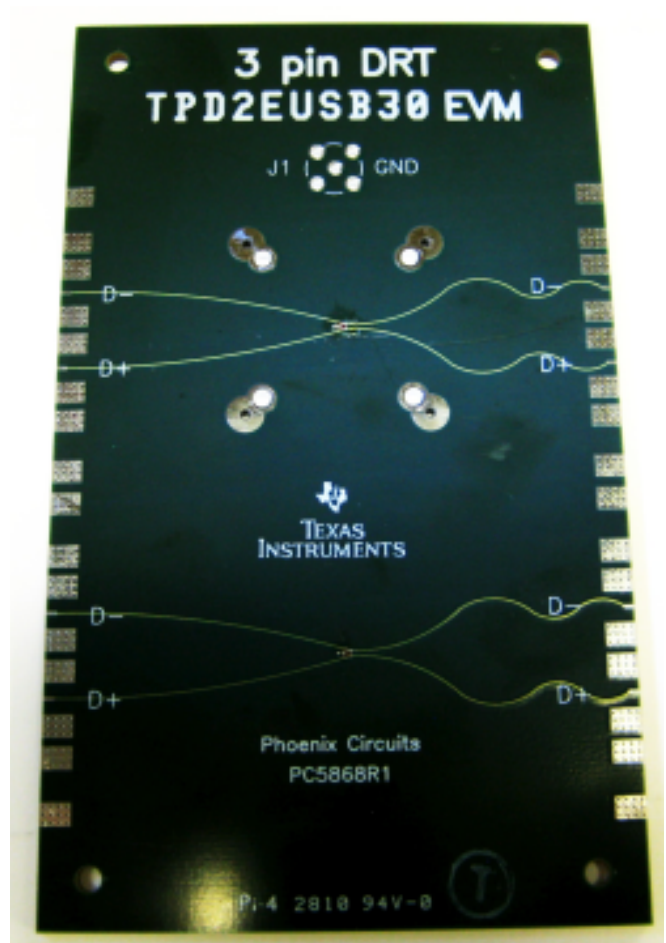

Figure 19. TPDxUSB30/A EVM – TPD2EUSB30/A Side

REVISION HISTORY

Changes from Original (August 2010) to Revision A	Page
<ul style="list-style-type: none">Added TPS2EUSB30A part to document.	1
Changes from Revision A (December 2010) to Revision B	Page
<ul style="list-style-type: none">Changed TOP-SIDE MARKING column in the Ordering Information Table.	2
Changes from Revision B (July 2011) to Revision C	Page
<ul style="list-style-type: none">Added Insertion Loss graphic to TYPICAL OPERATING CHARACTERISTICS section.	5
Changes from Revision December 2011 (C) to Revision D	Page
<ul style="list-style-type: none">Updated Dynamic Resistance value.Updated Dynamic Resistance value.	1 3

PACKAGING INFORMATION

Orderable Device	Status ⁽¹⁾	Package Type	Package Drawing	Pins	Package Qty	Eco Plan ⁽²⁾	Lead/ Ball Finish	MSL Peak Temp ⁽³⁾	Samples (Requires Login)
TPD2EUSB30ADRTR	ACTIVE	SOT	DRT	3	3000	Green (RoHS & no Sb/Br)	CU NIPDAU	Level-1-260C-UNLIM	
TPD2EUSB30DRTR	ACTIVE	SOT	DRT	3	3000	Green (RoHS & no Sb/Br)	CU NIPDAU	Level-1-260C-UNLIM	
TPD4EUSB30DQAR	ACTIVE	SON	DQA	10	3000	Green (RoHS & no Sb/Br)	CU NIPDAU	Level-1-260C-UNLIM	

⁽¹⁾ The marketing status values are defined as follows:

ACTIVE: Product device recommended for new designs.

LIFEBUY: TI has announced that the device will be discontinued, and a lifetime-buy period is in effect.

NRND: Not recommended for new designs. Device is in production to support existing customers, but TI does not recommend using this part in a new design.

PREVIEW: Device has been announced but is not in production. Samples may or may not be available.

OBSOLETE: TI has discontinued the production of the device.

⁽²⁾ Eco Plan - The planned eco-friendly classification: Pb-Free (RoHS), Pb-Free (RoHS Exempt), or Green (RoHS & no Sb/Br) - please check <http://www.ti.com/productcontent> for the latest availability information and additional product content details.

TBD: The Pb-Free/Green conversion plan has not been defined.

Pb-Free (RoHS): TI's terms "Lead-Free" or "Pb-Free" mean semiconductor products that are compatible with the current RoHS requirements for all 6 substances, including the requirement that lead not exceed 0.1% by weight in homogeneous materials. Where designed to be soldered at high temperatures, TI Pb-Free products are suitable for use in specified lead-free processes.

Pb-Free (RoHS Exempt): This component has a RoHS exemption for either 1) lead-based flip-chip solder bumps used between the die and package, or 2) lead-based die adhesive used between the die and leadframe. The component is otherwise considered Pb-Free (RoHS compatible) as defined above.

Green (RoHS & no Sb/Br): TI defines "Green" to mean Pb-Free (RoHS compatible), and free of Bromine (Br) and Antimony (Sb) based flame retardants (Br or Sb do not exceed 0.1% by weight in homogeneous material)

⁽³⁾ MSL, Peak Temp. -- The Moisture Sensitivity Level rating according to the JEDEC industry standard classifications, and peak solder temperature.

Important Information and Disclaimer: The information provided on this page represents TI's knowledge and belief as of the date that it is provided. TI bases its knowledge and belief on information provided by third parties, and makes no representation or warranty as to the accuracy of such information. Efforts are underway to better integrate information from third parties. TI has taken and continues to take reasonable steps to provide representative and accurate information but may not have conducted destructive testing or chemical analysis on incoming materials and chemicals. TI and TI suppliers consider certain information to be proprietary, and thus CAS numbers and other limited information may not be available for release.

In no event shall TI's liability arising out of such information exceed the total purchase price of the TI part(s) at issue in this document sold by TI to Customer on an annual basis.

TAPE AND REEL INFORMATION
REEL DIMENSIONS

TAPE DIMENSIONS

A0	Dimension designed to accommodate the component width
B0	Dimension designed to accommodate the component length
K0	Dimension designed to accommodate the component thickness
W	Overall width of the carrier tape
P1	Pitch between successive cavity centers

TAPE AND REEL INFORMATION

*All dimensions are nominal

Device	Package Type	Package Drawing	Pins	SPQ	Reel Diameter (mm)	Reel Width W1 (mm)	A0 (mm)	B0 (mm)	K0 (mm)	P1 (mm)	W (mm)	Pin1 Quadrant
TPD2EUSB30ADRTR	SOT	DRT	3	3000	180.0	8.4	1.16	1.16	0.63	4.0	8.0	Q3
TPD2EUSB30DRTR	SOT	DRT	3	3000	180.0	8.4	1.16	1.16	0.63	4.0	8.0	Q3
TPD4EUSB30DQAR	SON	DQA	10	3000	180.0	8.4	1.3	2.83	0.65	4.0	8.0	Q1
TPD4EUSB30DQAR	SON	DQA	10	3000	179.0	8.4	1.25	2.8	0.7	4.0	8.0	Q1

TAPE AND REEL BOX DIMENSIONS

*All dimensions are nominal

Device	Package Type	Package Drawing	Pins	SPQ	Length (mm)	Width (mm)	Height (mm)
TPD2EUSB30ADRTR	SOT	DRT	3	3000	202.0	201.0	28.0
TPD2EUSB30DRTR	SOT	DRT	3	3000	202.0	201.0	28.0
TPD4EUSB30DQAR	SON	DQA	10	3000	202.0	201.0	28.0
TPD4EUSB30DQAR	SON	DQA	10	3000	203.0	203.0	35.0

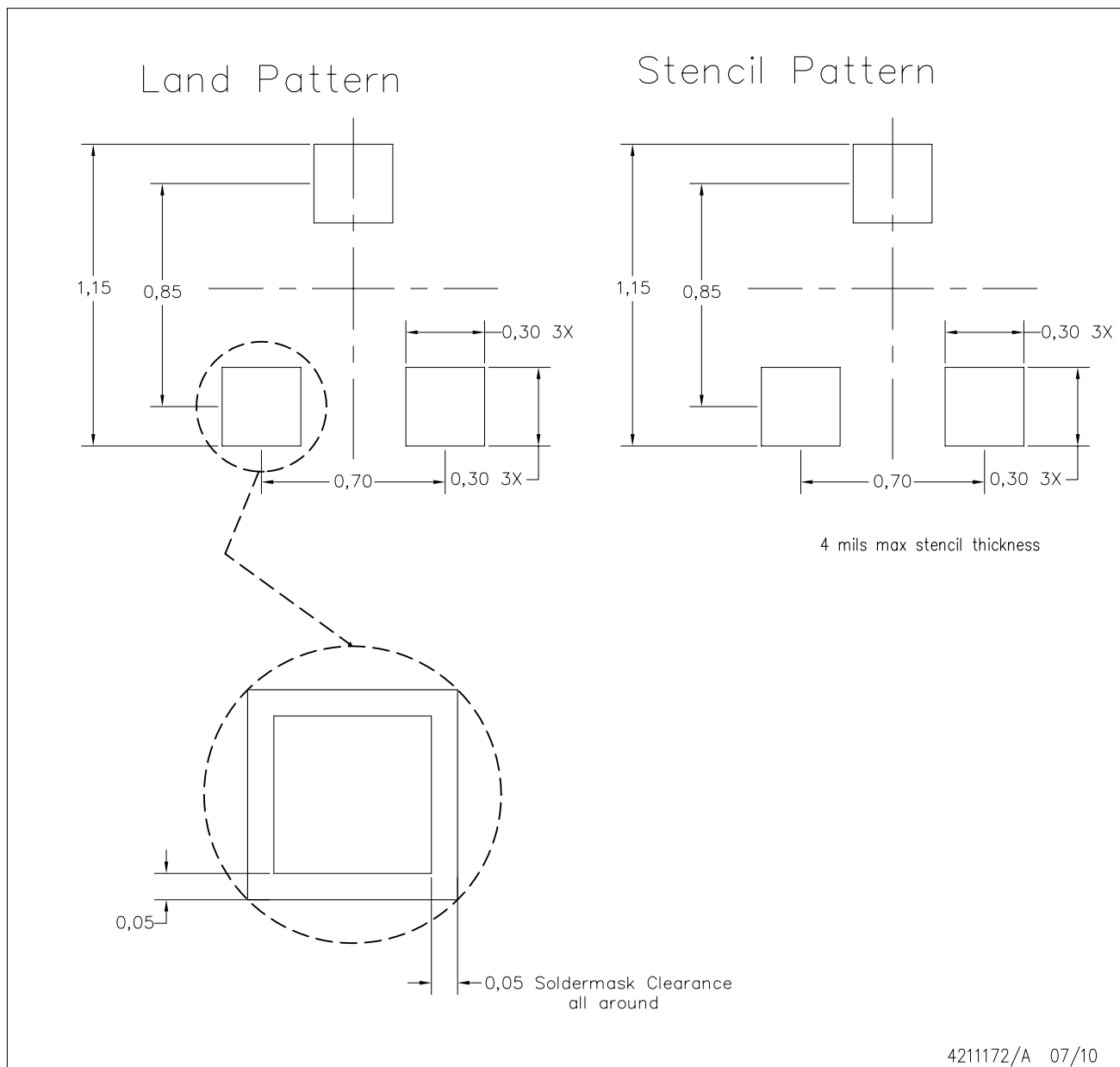

- NOTES:
- A. All linear dimensions are in millimeters.
 - B. This drawing is subject to change without notice.
 - C. Publication IPC-7351 is recommended for alternate designs.
 - D. Customers should contact their board fabrication site for minimum solder mask web tolerances between signal pads.
 - E. Maximum stencil thickness 0,1016 mm (4 mils). All linear dimensions are in millimeters.
 - F. Laser cutting apertures with trapezoidal walls and also rounding corners will offer better paste release. Customers should contact their board assembly site for stencil design recommendations. Refer to IPC 7525 for stencil design considerations.
 - G. Side aperture dimensions over-print land for acceptable area ratio > 0.66. Customer may reduce side aperture dimensions if stencil manufacturing process allows for sufficient release at smaller opening.

DQA (R-PSON-N10)

PLASTIC SMALL OUTLINE NO-LEAD

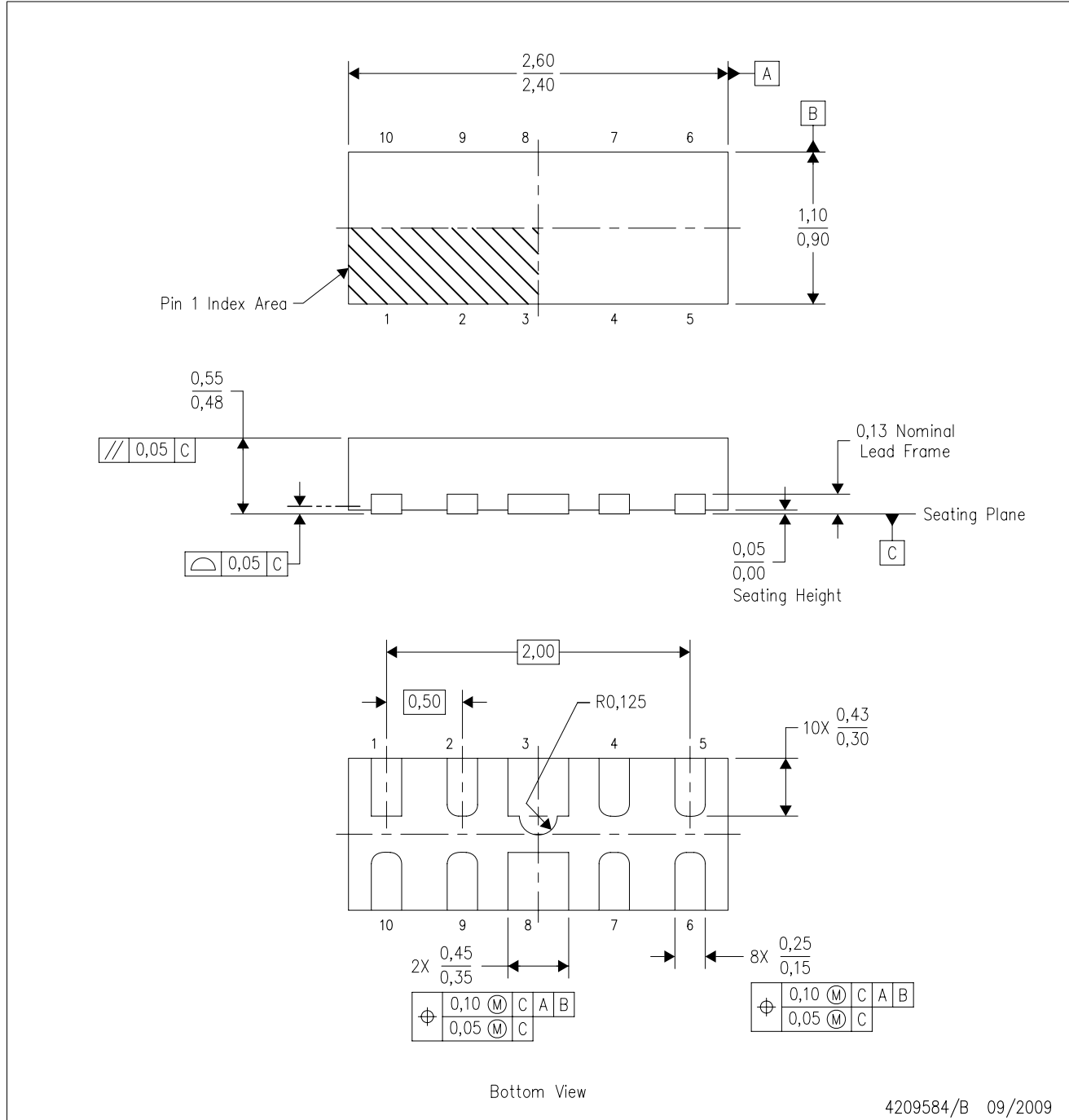

4209584/B 09/2009

- NOTES:
- A. All linear dimensions are in millimeters. Dimensioning and tolerancing per ASME Y14.5M-1994.
 - B. This drawing is subject to change without notice.
 - C. SON (Small Outline No-Lead) package configuration.

DQA (R-PUSON-N10)

PLASTIC SMALL OUTLINE NO-LEAD

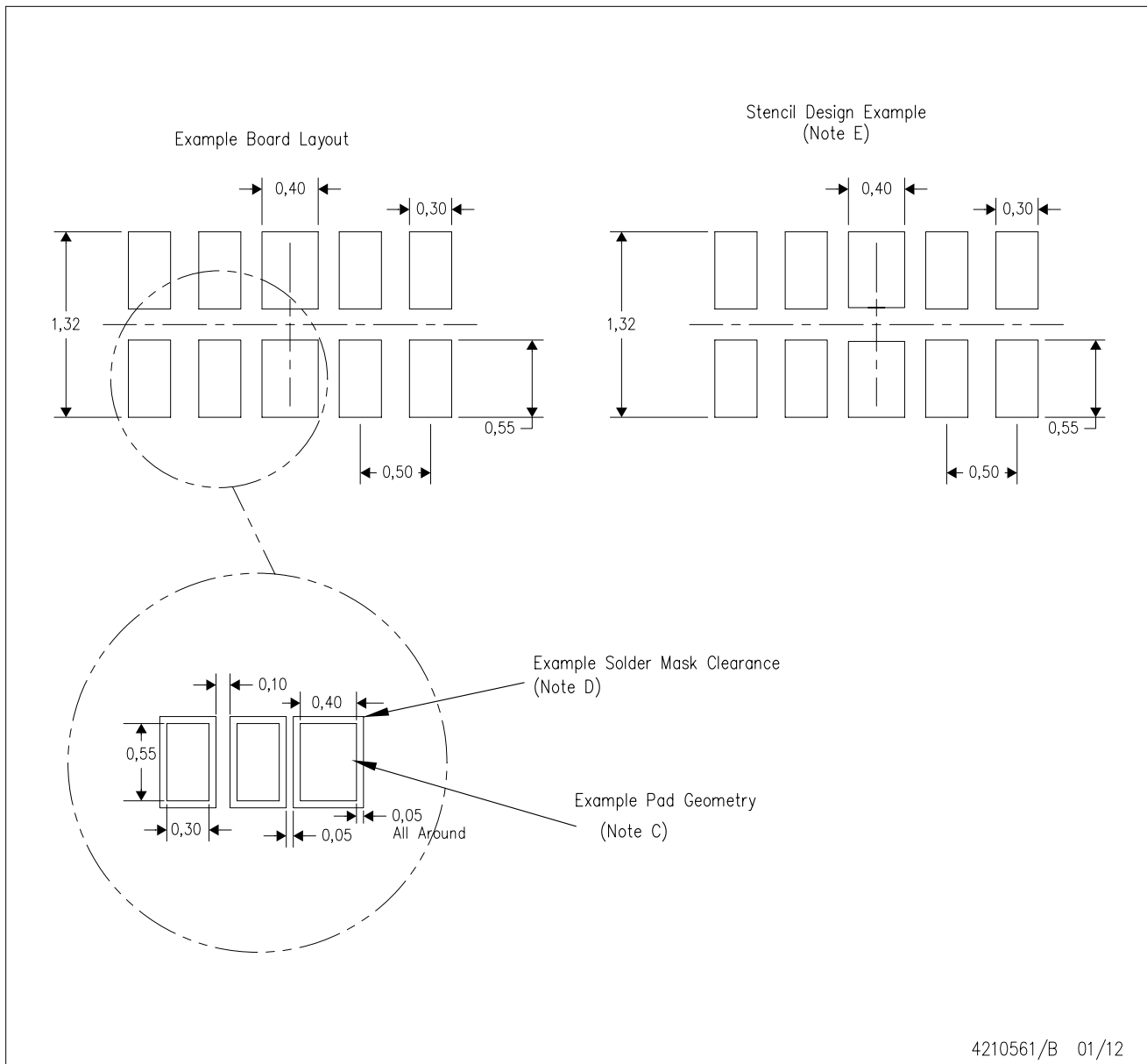

- NOTES:
- All linear dimensions are in millimeters.
 - This drawing is subject to change without notice.
 - Publication IPC-7351 is recommended for alternate designs.
 - Customers should contact their board fabrication site for minimum solder mask web tolerances between signal pads.
 - Maximum stencil thickness 0,127 mm (5 mils). All linear dimensions are in millimeters.
 - Laser cutting apertures with trapezoidal walls and also rounding corners will offer better paste release. Customers should contact their board assembly site for stencil design recommendations. Refer to IPC 7525 for stencil design considerations.
 - Side aperture dimensions over-print land for acceptable area ratio > 0.66. Customer may reduce side aperture dimensions if stencil manufacturing process allows for sufficient release at smaller opening.

IMPORTANT NOTICE

Texas Instruments Incorporated and its subsidiaries (TI) reserve the right to make corrections, enhancements, improvements and other changes to its semiconductor products and services per JESD46C and to discontinue any product or service per JESD48B. Buyers should obtain the latest relevant information before placing orders and should verify that such information is current and complete. All semiconductor products (also referred to herein as "components") are sold subject to TI's terms and conditions of sale supplied at the time of order acknowledgment.

TI warrants performance of its components to the specifications applicable at the time of sale, in accordance with the warranty in TI's terms and conditions of sale of semiconductor products. Testing and other quality control techniques are used to the extent TI deems necessary to support this warranty. Except where mandated by applicable law, testing of all parameters of each component is not necessarily performed.

TI assumes no liability for applications assistance or the design of Buyers' products. Buyers are responsible for their products and applications using TI components. To minimize the risks associated with Buyers' products and applications, Buyers should provide adequate design and operating safeguards.

TI does not warrant or represent that any license, either express or implied, is granted under any patent right, copyright, mask work right, or other intellectual property right relating to any combination, machine, or process in which TI components or services are used. Information published by TI regarding third-party products or services does not constitute a license to use such products or services or a warranty or endorsement thereof. Use of such information may require a license from a third party under the patents or other intellectual property of the third party, or a license from TI under the patents or other intellectual property of TI.

Reproduction of significant portions of TI information in TI data books or data sheets is permissible only if reproduction is without alteration and is accompanied by all associated warranties, conditions, limitations, and notices. TI is not responsible or liable for such altered documentation. Information of third parties may be subject to additional restrictions.

Resale of TI components or services with statements different from or beyond the parameters stated by TI for that component or service voids all express and any implied warranties for the associated TI component or service and is an unfair and deceptive business practice. TI is not responsible or liable for any such statements.

Buyer acknowledges and agrees that it is solely responsible for compliance with all legal, regulatory and safety-related requirements concerning its products, and any use of TI components in its applications, notwithstanding any applications-related information or support that may be provided by TI. Buyer represents and agrees that it has all the necessary expertise to create and implement safeguards which anticipate dangerous consequences of failures, monitor failures and their consequences, lessen the likelihood of failures that might cause harm and take appropriate remedial actions. Buyer will fully indemnify TI and its representatives against any damages arising out of the use of any TI components in safety-critical applications.

In some cases, TI components may be promoted specifically to facilitate safety-related applications. With such components, TI's goal is to help enable customers to design and create their own end-product solutions that meet applicable functional safety standards and requirements. Nonetheless, such components are subject to these terms.

No TI components are authorized for use in FDA Class III (or similar life-critical medical equipment) unless authorized officers of the parties have executed a special agreement specifically governing such use.

Only those TI components which TI has specifically designated as military grade or "enhanced plastic" are designed and intended for use in military/aerospace applications or environments. Buyer acknowledges and agrees that any military or aerospace use of TI components which have **not** been so designated is solely at the Buyer's risk, and that Buyer is solely responsible for compliance with all legal and regulatory requirements in connection with such use.

TI has specifically designated certain components which meet ISO/TS16949 requirements, mainly for automotive use. Components which have not been so designated are neither designed nor intended for automotive use; and TI will not be responsible for any failure of such components to meet such requirements.

Products

Audio	www.ti.com/audio
Amplifiers	amplifier.ti.com
Data Converters	dataconverter.ti.com
DLP® Products	www.dlp.com
DSP	dsp.ti.com
Clocks and Timers	www.ti.com/clocks
Interface	interface.ti.com
Logic	logic.ti.com
Power Mgmt	power.ti.com
Microcontrollers	microcontroller.ti.com
RFID	www.ti-rfid.com
OMAP Mobile Processors	www.ti.com/omap
Wireless Connectivity	www.ti.com/wirelessconnectivity

Applications

Automotive and Transportation	www.ti.com/automotive
Communications and Telecom	www.ti.com/communications
Computers and Peripherals	www.ti.com/computers
Consumer Electronics	www.ti.com/consumer-apps
Energy and Lighting	www.ti.com/energy
Industrial	www.ti.com/industrial
Medical	www.ti.com/medical
Security	www.ti.com/security
Space, Avionics and Defense	www.ti.com/space-avionics-defense
Video and Imaging	www.ti.com/video

TI E2E Community e2e.ti.com