

FAMILY OF NANOPOWER PUSH-PULL OUTPUT COMPARATORS

FEATURES

- Qualification in Accordance With AEC-Q100†
- Qualified for Automotive Applications
- Customer-Specific Configuration Control Can Be Supported Along With Major-Change Approval
- ESD Protection Exceeds 2000 V Per MIL-STD-883, Method 3015; Exceeds 200 V Using Machine Model (C = 200 pF, R = 0)
- Low Supply Current . . . 560 nA/Per Channel
- Input Common-Mode Range Exceeds the Rails . . . -0.1 V to V_{CC} + 5 V
- Supply Voltage Range . . . 2.7 V to 16 V
- Reverse Battery Protection Up to 18 V
- Push-Pull CMOS Output Stage
- Specified Temperature Range
 - -40°C to 125°C – Automotive Grade
- Ultrasmall Packaging
 - 5-Pin SOT-23 (TLV3701)
- Universal Op-Amp EVM (Reference SLOU060 for more information)

† Contact factory for details. Q100 qualification data available on request.

APPLICATIONS

- Low Power Automotive Electronics
- Security Detection Systems

DESCRIPTION

The TLV370x is Texas Instruments' first family of nanopower comparators with only 560 nA per channel supply current, which make this device ideal for low power applications.

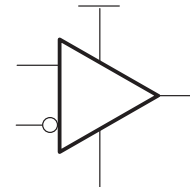

**SUPPLY CURRENT
vs
SUPPLY VOLTAGE**

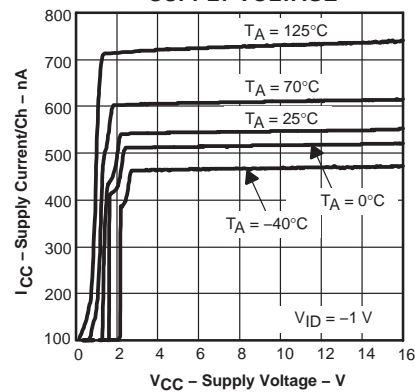

high side voltage sense circuit

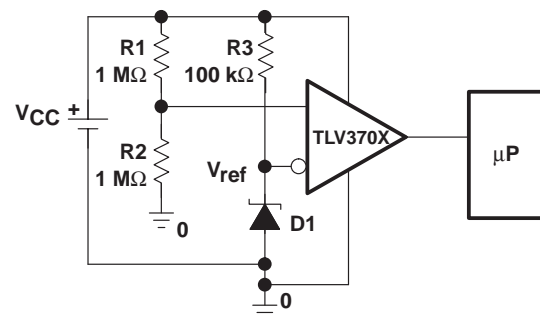

Please be aware that an important notice concerning availability, standard warranty, and use in critical applications of Texas Instruments semiconductor products and disclaimers thereto appears at the end of this data sheet.

TLV3701-Q1
TLV3702-Q1
TLV3704-Q1

SGLS154C – NOVEMBER 2000 – REVISED NOVEMBER 2003

DESCRIPTION (continued)

The TLV370x has a minimum operating supply voltage of 2.7 V over the extended automotive temperature range ($T_A = -40^\circ\text{C}$ to 125°C), while having an input common-mode range of -0.1 to $V_{CC} + 5$ V. The low supply current makes it an ideal choice for low power applications where quiescent current is the primary concern. Reverse battery protection guards the amplifier from an over-current condition due to improper battery installation. For harsh environments, the inputs can be taken 5 V above the positive supply rail without damage to the device.

Devices are available in SOIC with the singles in the small SOT-23 package. Other package options may be made available upon request.

A SELECTION OF OUTPUT COMPARATORST

DEVICE	V _{CC} (V)	V _{IO} (μV)	I _{CC/Ch} (μA)	I _B (pA)	t _{PLH} (μs)	t _{PHL} (μs)	t _f (μs)	t _r (μs)	RAIL-TO-RAIL	OUTPUT STAGE
TLV370x	2.5 – 16	250	0.56	80	56	83	22	8	I	PP
TLV340x	2.5 – 16	250	0.47	80	55	30	5	–	I	OD
TLC3702/4	3 – 16	1200	9	5	1.1	0.65	0.5	0.125	–	PP
TLC393/339	3 – 16	1400	11	5	1.1	0.55	0.22	–	–	OD
TLC372/4	3 – 16	1000	75	5	0.65	0.65	–	–	–	OD

† All specifications are typical values measured at 5 V.

TLV3701 AVAILABLE OPTIONS

T _A	V _{IOmax} AT 25°C	PACKAGED DEVICES		
		SMALL OUTLINE (D)	SOT-23 (DBV)‡	SYMBOL
-40°C to 125°C	5000 μV	TLV3701QDRQ1†	TLV3701QDBVRQ1	VBCQ

† Product Preview

‡ This package is only available taped and reeled with standard quantities of 3000 pieces per reel.

TLV3702 AVAILABLE OPTIONS

T _A	V _{IOmax} AT 25°C	PACKAGED DEVICES	
		SMALL OUTLINE (D)	SYMBOL
-40°C to 125°C	5000 μV	TLV3702QDRQ1	3702Q1

TLV3704 AVAILABLE OPTIONS

T _A	V _{IOmax} AT 25°C	PACKAGED DEVICES
		SMALL OUTLINE (D)
-40°C to 125°C	5000 μV	TLV3704QDRQ1†

† Product Preview

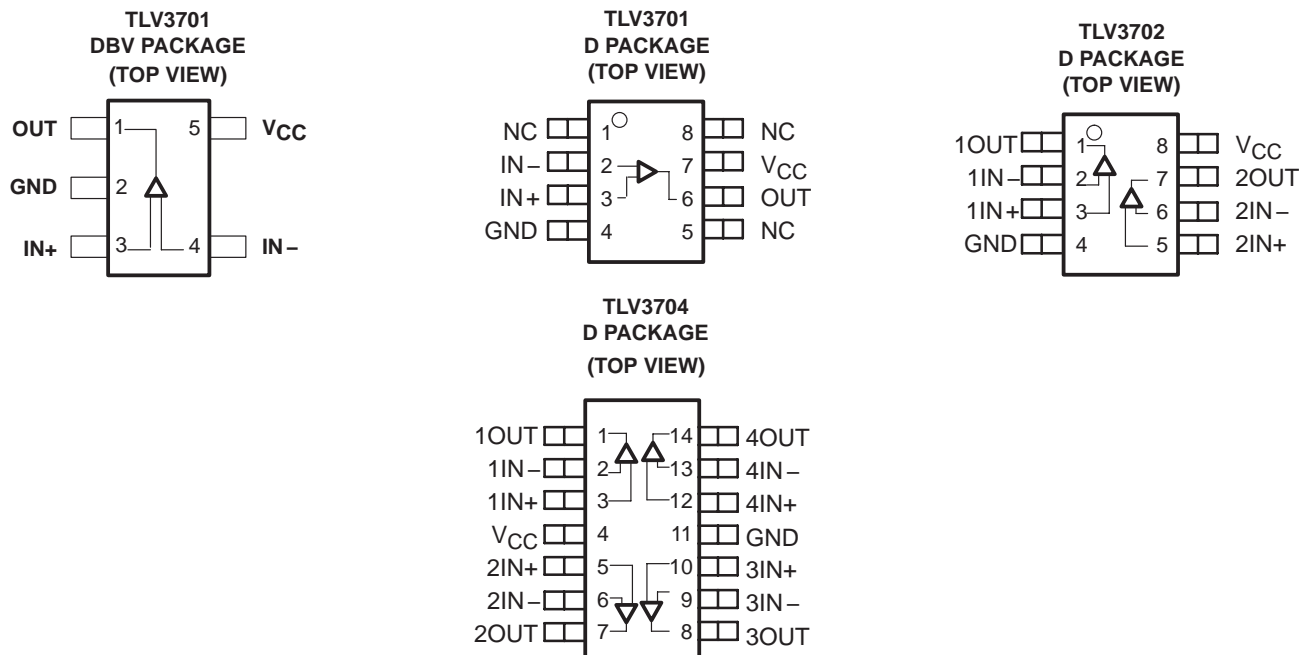

absolute maximum ratings over operating free-air temperature range (unless otherwise noted)†

Supply voltage, V_{CC} (see Note 1)	17 V
Differential input voltage, V_{ID}	± 20 V
Input voltage range, V_I (see Notes 1 and 2)	0 to $V_{CC} + 5$ V
Input current range, I_I	± 10 mA
Output current range, I_O	± 10 mA
Continuous total power dissipation	See Dissipation Rating Table
Operating free-air temperature range, T_A : Q suffix	-40°C to 125°C
Maximum junction temperature, T_J	150°C
Storage temperature range, T_{stg}	-65°C to 150°C
Lead temperature 1,6 mm (1/16 inch) from case for 10 seconds	260°C

† Stresses beyond those listed under “absolute maximum ratings” may cause permanent damage to the device. These are stress ratings only, and functional operation of the device at these or any other conditions beyond those indicated under “recommended operating conditions” is not implied. Exposure to absolute-maximum-rated conditions for extended periods may affect device reliability.

- NOTES: 1. All voltage values, except differential voltages, are with respect to GND.
 2. Input voltage range is limited to 20 V max or $V_{CC} + 5$ V, whichever is smaller.

DISSIPATION RATING TABLE

PACKAGE	θ_{JC} ($^\circ\text{C}/\text{W}$)	θ_{JA} ($^\circ\text{C}/\text{W}$)	$T_A \leq 25^\circ\text{C}$ POWER RATING	$T_A = 125^\circ\text{C}$ POWER RATING
D (8)	38.3	176	710 mW	142 mW
D (14)	26.9	122.6	1022 mW	204.4 mW
DBV (5)	55	324.1	385 mW	77.1 mW

TLV3701-Q1
TLV3702-Q1
TLV3704-Q1

SGLS154C – NOVEMBER 2000 – REVISED NOVEMBER 2003

recommended operating conditions

		MIN	MAX	UNIT
Supply voltage, V_{CC}	Single supply	2.7	16	V
	Split supply	± 1.35	± 8	
Common-mode input voltage range, V_{ICR}		-0.1	$V_{CC}+5$	V
Operating free-air temperature, T_A	Q-suffix	-40	125	$^{\circ}\text{C}$

electrical characteristics at specified operating free-air temperature, $V_{CC} = 2.7\text{ V}, 5\text{ V}, 15\text{ V}$ (unless otherwise noted)

dc performance

PARAMETER	TEST CONDITIONS	T_A^{\dagger}	MIN	TYP	MAX	UNIT
V_{IO} Input offset voltage	$V_{IC} = V_{CC}/2, R_S = 50\ \Omega$	25 $^{\circ}\text{C}$		250	5000	μV
		Full range			7000	
αV_{IO} Offset voltage drift		25 $^{\circ}\text{C}$		3		$\mu\text{V}/^{\circ}\text{C}$
CMRR Common-mode rejection ratio	$V_{IC} = 0\text{ to }2.7\text{ V}, R_S = 50\ \Omega$	25 $^{\circ}\text{C}$	55	72		dB
		Full range	50			
	$V_{IC} = 0\text{ to }5\text{ V}, R_S = 50\ \Omega$	25 $^{\circ}\text{C}$	60	76		
		Full range	55			
$V_{IC} = 0\text{ to }15\text{ V}, R_S = 50\ \Omega$	25 $^{\circ}\text{C}$	65	88			
	Full range	60				
A_{VD} Large-signal differential voltage amplification		25 $^{\circ}\text{C}$		1000		V/mV

\dagger Full range is -40 $^{\circ}\text{C}$ to 125 $^{\circ}\text{C}$ for Q suffix.

input/output characteristics

PARAMETER	TEST CONDITIONS	T_A^{\dagger}	MIN	TYP	MAX	UNIT
I_{IO} Input offset current	$V_{IC} = V_{CC}/2, R_S = 50\ \Omega$	25 $^{\circ}\text{C}$		20	100	pA
		Full range			1000	
I_{IB} Input bias current		25 $^{\circ}\text{C}$		80	250	pA
		Full range			2000	
$r_{i(d)}$ Differential input resistance		25 $^{\circ}\text{C}$		300		M Ω
V_{OH} High-level output voltage	$V_{IC} = V_{CC}/2, I_{OH} = 2\ \mu\text{A}, V_{ID} = 1\text{ V}$	25 $^{\circ}\text{C}$		$V_{CC}-0.08$		mV
		Full range		$V_{CC}-320$		
	$V_{IC} = V_{CC}/2, I_{OH} = -50\ \mu\text{A}, V_{ID} = 1\text{ V}$	Full range		$V_{CC}-450$		
V_{OL} Low-level output voltage	$V_{IC} = V_{CC}/2, I_{OH} = 2\ \mu\text{A}, V_{ID} = -1\text{ V}$	25 $^{\circ}\text{C}$		8		mV
		Full range		80	200	
	$V_{IC} = V_{CC}/2, I_{OH} = 50\ \mu\text{A}, V_{ID} = -1\text{ V}$	Full range			300	

\dagger Full range is -40 $^{\circ}\text{C}$ to 125 $^{\circ}\text{C}$ for Q suffix.

electrical characteristics at specified operating free-air temperature, $V_{CC} = 2.7\text{ V}, 5\text{ V}, 15\text{ V}$ (unless otherwise noted) (continued)

power supply

PARAMETER		TEST CONDITIONS		T_A †	MIN	TYP	MAX	UNIT
I_{CC}	Supply current (per channel)	Output state high		25°C		560	800	nA
				Full range			1200	
PSRR	Power supply rejection ratio	$V_{IC} = V_{CC}/2\text{ V}$, No load	$V_{CC} = 2.7\text{ V to }5\text{ V}$	25°C	75	100	dB	
				Full range	70			
			$V_{CC} = 5\text{ V to }15\text{ V}$	25°C	85	105		
				Full range	80			

† Full range is -40°C to 125°C for Q suffix.

switching characteristics at recommended operating conditions, $V_{CC} = 2.7\text{ V}, 5\text{ V}, 15\text{ V}$, $T_A = 25^\circ\text{C}$ (unless otherwise noted)

PARAMETER		TEST CONDITIONS		MIN	TYP	MAX	UNIT
$t_{(PLH)}$	Propagation response time, low-to-high-level output (see Note 3)	$f = 1\text{ kHz}$, $V_{STEP} = 100\text{ mV}$, $C_L = 10\text{ pF}$, $V_{CC} = 2.7\text{ V}$, $V_{IC} = V_{CC}/2$		Overdrive = 2 mV	240		μs
				Overdrive = 10 mV	64	150†	
				Overdrive = 50 mV	36		
$t_{(PHL)}$	Propagation response time, high-to-low-level output (see Note 3)	$f = 1\text{ kHz}$, $V_{STEP} = 100\text{ mV}$, $C_L = 10\text{ pF}$, $V_{CC} = 2.7\text{ V}$, $V_{IC} = V_{CC}/2$		Overdrive = 2 mV	167		μs
				Overdrive = 10 mV	67	150†	
				Overdrive = 50 mV	37		
t_r	Rise time	$C_L = 10\text{ pF}$, $V_{CC} = 2.7\text{ V}$			7		μs
t_f	Fall time	$C_L = 10\text{ pF}$, $V_{CC} = 2.7\text{ V}$			9		μs

NOTE 3: The response time specified is the interval between the input step function and the instant when the output crosses 1.4 V. Propagation responses are longer at higher supply voltages, refer to Figures 11–16 for further details.

† This limit applies to the TLV3701-Q1 only.

TYPICAL CHARACTERISTICS

Table of Graphs

			FIGURE
	Input bias/offset current	vs Free-air temperature	1
V_{OL}	Low-level output voltage	vs Low-level output current	2, 4, 6
V_{OH}	High-level output voltage	vs High-level output current	3, 5, 7
I_{CC}	Supply current	vs Supply voltage	8
		vs Free-air temperature	9
	Output fall time/rise time	vs Supply voltage	10
	Low-to-high level output response for various input overdrives		11, 13, 15
	High-to-low level output response for various input overdrives		12, 14, 16

TYPICAL CHARACTERISTICS

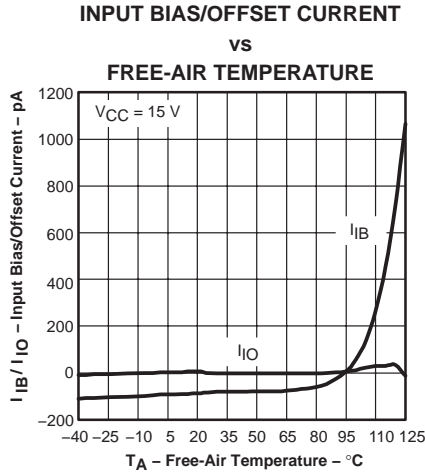

Figure 1

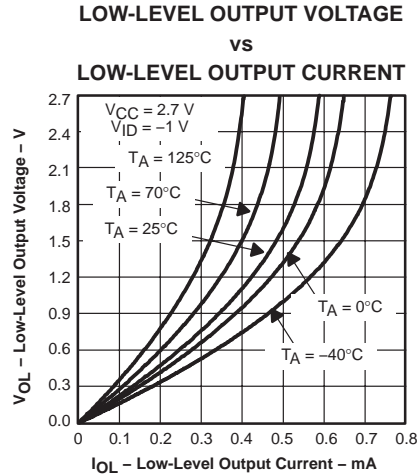

Figure 2

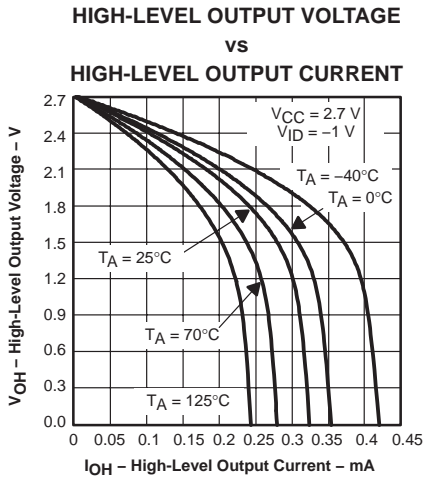

Figure 3

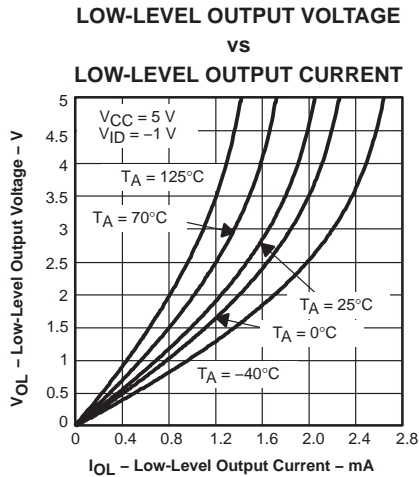

Figure 4

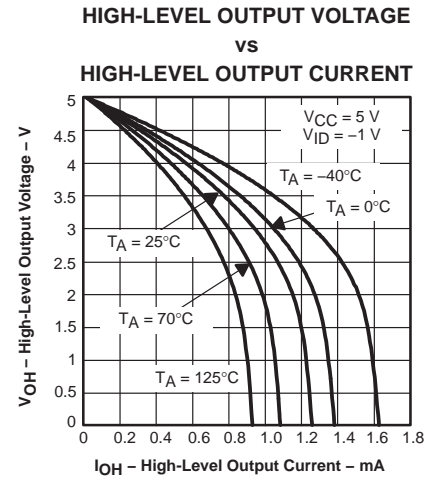

Figure 5

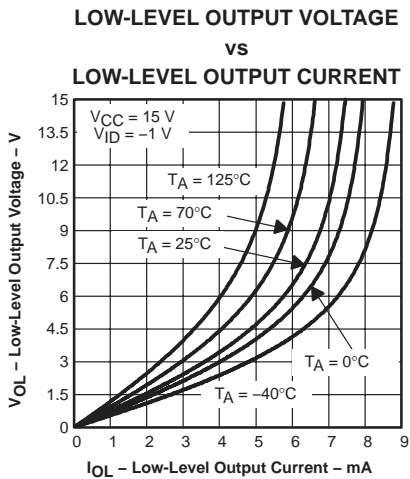

Figure 6

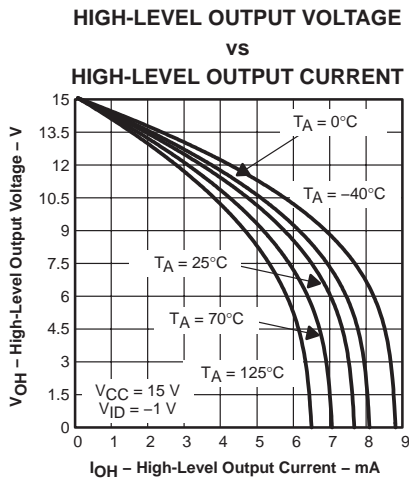

Figure 7

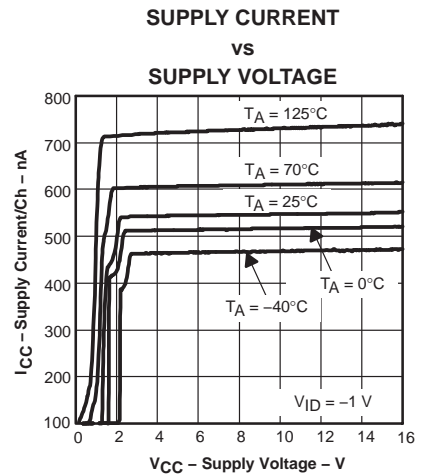

Figure 8

TYPICAL CHARACTERISTICS

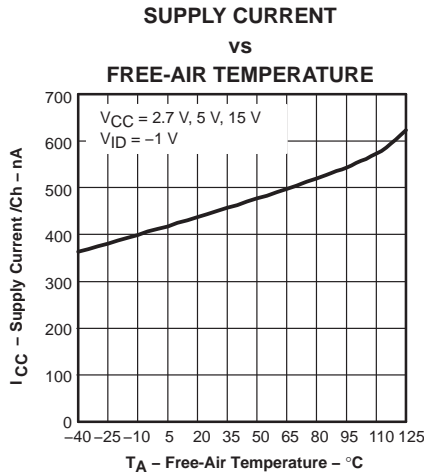

Figure 9

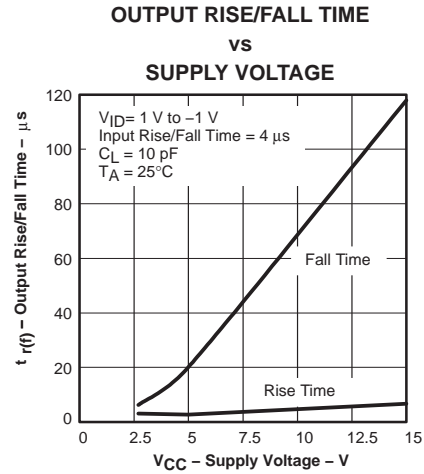

Figure 10

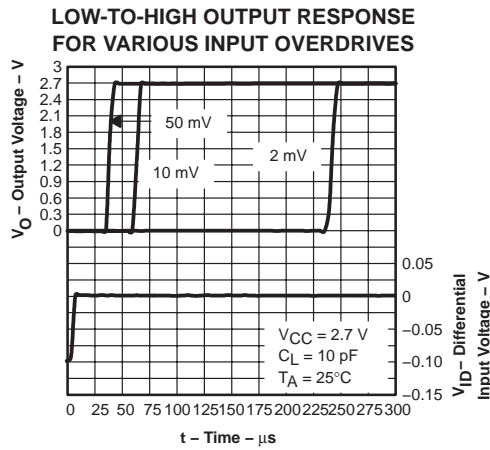

Figure 11

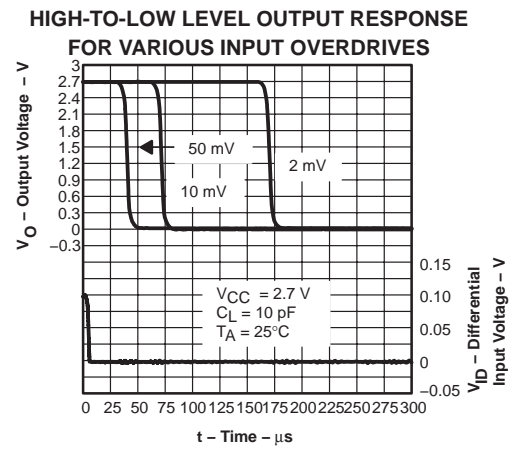

Figure 12

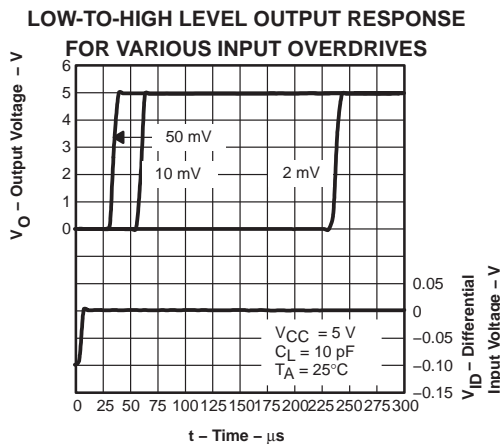

Figure 13

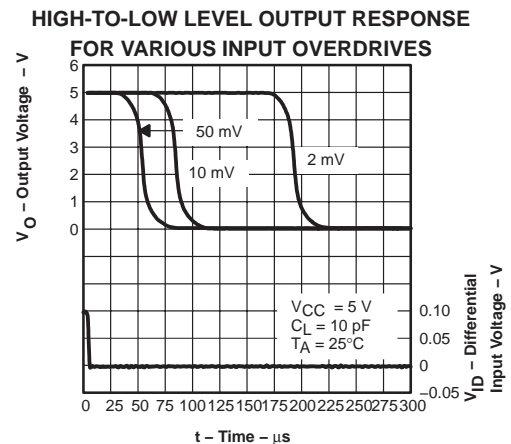

Figure 14

TYPICAL CHARACTERISTICS

LOW-TO-HIGH LEVEL OUTPUT RESPONSE
 FOR VARIOUS INPUT OVERDRIVES

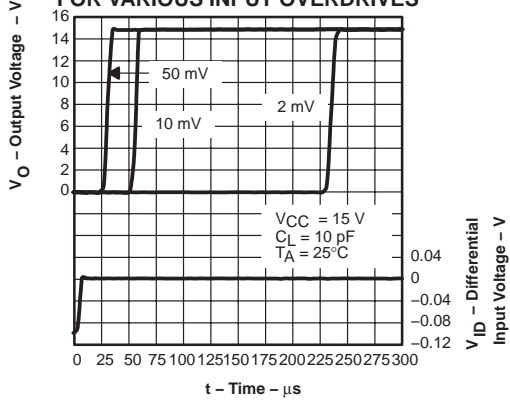

Figure 15

HIGH-TO-LOW LEVEL OUTPUT RESPONSE
 FOR VARIOUS INPUT OVERDRIVES

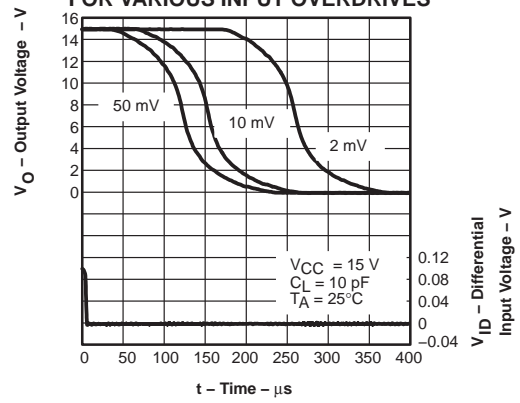
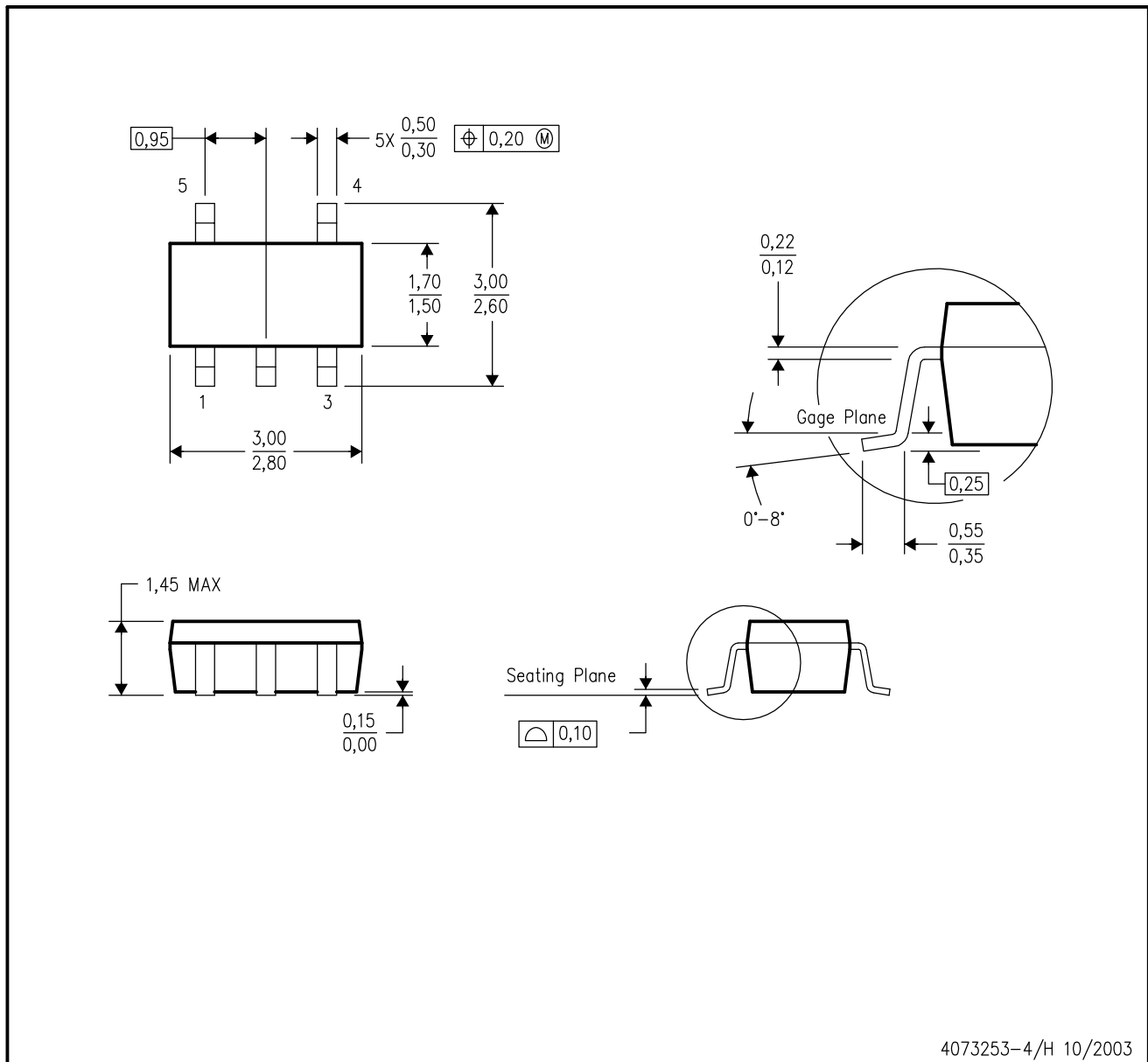

Figure 16

DBV (R-PDSO-G5)

PLASTIC SMALL-OUTLINE PACKAGE



- NOTES:
- A. All linear dimensions are in millimeters.
 - B. This drawing is subject to change without notice.
 - C. Body dimensions do not include mold flash or protrusion.
 - D. Falls within JEDEC MO-178 Variation AA.

D (R-PDSO-G8)

PLASTIC SMALL-OUTLINE PACKAGE

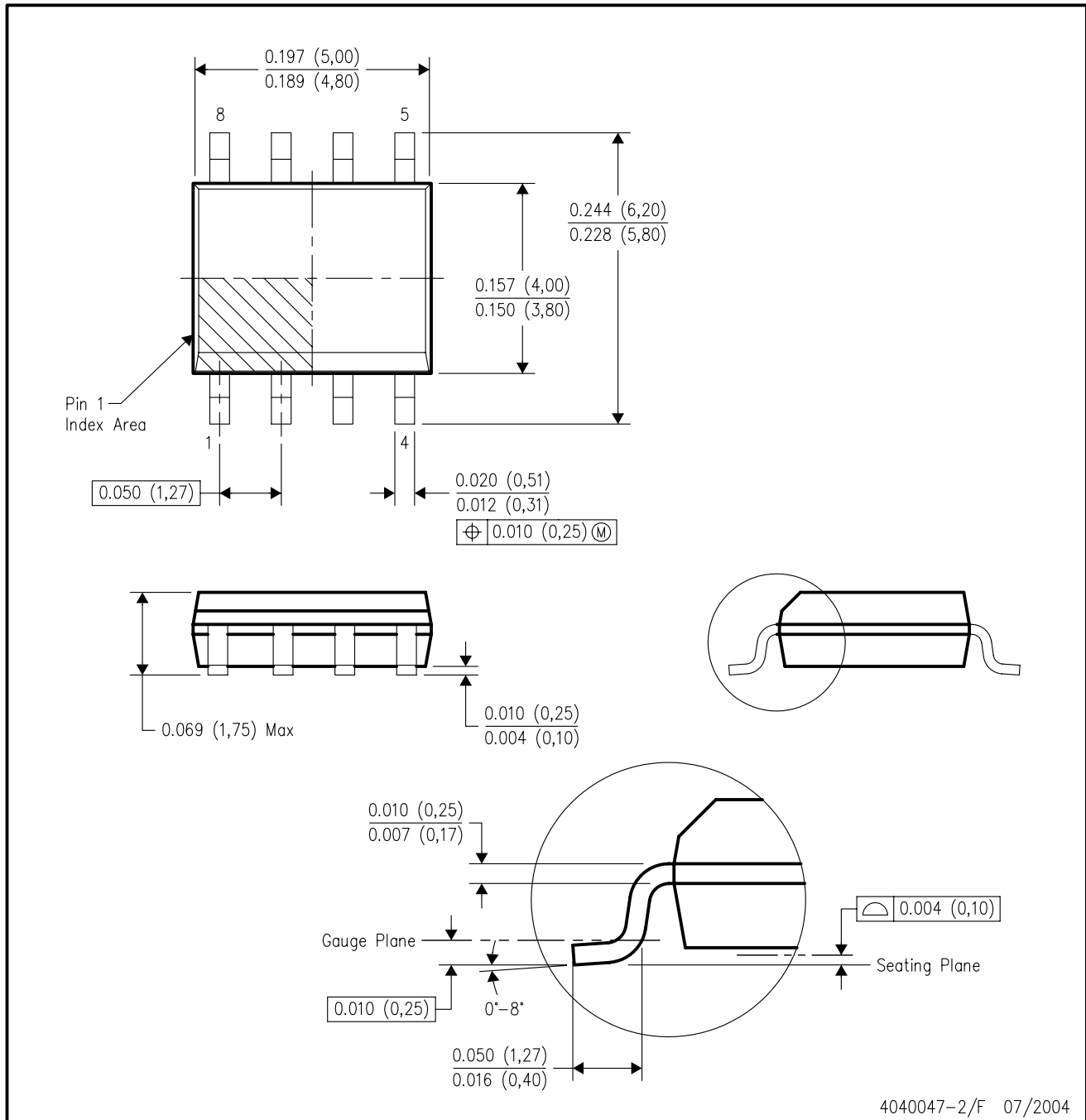

- NOTES:
- A. All linear dimensions are in inches (millimeters).
 - B. This drawing is subject to change without notice.
 - C. Body dimensions do not include mold flash or protrusion not to exceed 0.006 (0,15).
 - D. Falls within JEDEC MS-012 variation AA.

IMPORTANT NOTICE

Texas Instruments Incorporated and its subsidiaries (TI) reserve the right to make corrections, modifications, enhancements, improvements, and other changes to its products and services at any time and to discontinue any product or service without notice. Customers should obtain the latest relevant information before placing orders and should verify that such information is current and complete. All products are sold subject to TI's terms and conditions of sale supplied at the time of order acknowledgment.

TI warrants performance of its hardware products to the specifications applicable at the time of sale in accordance with TI's standard warranty. Testing and other quality control techniques are used to the extent TI deems necessary to support this warranty. Except where mandated by government requirements, testing of all parameters of each product is not necessarily performed.

TI assumes no liability for applications assistance or customer product design. Customers are responsible for their products and applications using TI components. To minimize the risks associated with customer products and applications, customers should provide adequate design and operating safeguards.

TI does not warrant or represent that any license, either express or implied, is granted under any TI patent right, copyright, mask work right, or other TI intellectual property right relating to any combination, machine, or process in which TI products or services are used. Information published by TI regarding third-party products or services does not constitute a license from TI to use such products or services or a warranty or endorsement thereof. Use of such information may require a license from a third party under the patents or other intellectual property of the third party, or a license from TI under the patents or other intellectual property of TI.

Reproduction of information in TI data books or data sheets is permissible only if reproduction is without alteration and is accompanied by all associated warranties, conditions, limitations, and notices. Reproduction of this information with alteration is an unfair and deceptive business practice. TI is not responsible or liable for such altered documentation.

Resale of TI products or services with statements different from or beyond the parameters stated by TI for that product or service voids all express and any implied warranties for the associated TI product or service and is an unfair and deceptive business practice. TI is not responsible or liable for any such statements.

Following are URLs where you can obtain information on other Texas Instruments products and application solutions:

Products		Applications	
Amplifiers	amplifier.ti.com	Audio	www.ti.com/audio
Data Converters	dataconverter.ti.com	Automotive	www.ti.com/automotive
DSP	dsp.ti.com	Broadband	www.ti.com/broadband
Interface	interface.ti.com	Digital Control	www.ti.com/digitalcontrol
Logic	logic.ti.com	Military	www.ti.com/military
Power Mgmt	power.ti.com	Optical Networking	www.ti.com/opticalnetwork
Microcontrollers	microcontroller.ti.com	Security	www.ti.com/security
		Telephony	www.ti.com/telephony
		Video & Imaging	www.ti.com/video
		Wireless	www.ti.com/wireless

Mailing Address: Texas Instruments
Post Office Box 655303 Dallas, Texas 75265

Copyright © 2004, Texas Instruments Incorporated