

FAMILY OF NANOPOWER PUSH-PULL OUTPUT COMPARATORS

FEATURES

- Low Supply Current . . . 560 nA/Per Channel
- Input Common-Mode Range Exceeds the Rails . . . -0.1 V to $V_{CC} + 5\text{ V}$
- Supply Voltage Range . . . 2.5 V to 16 V
- Reverse Battery Protection Up to 18 V
- Push-Pull CMOS Output Stage
- Specified Temperature Range
 - 0°C to 70°C – Commercial Grade
 - -40°C to 125°C – Industrial Grade
- Ultrasmall Packaging
 - 5-Pin SOT-23 (TLV3701)
 - 8-Pin MSOP (TLV3702)
- Universal Op-Amp EVM (Reference SLOU060 for more information)

All members are available in PDIP and SOIC with the singles in the small SOT-23 package, duals in the MSOP, and quads in the TSSOP package.

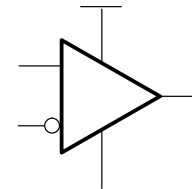

SUPPLY CURRENT
vs
SUPPLY VOLTAGE

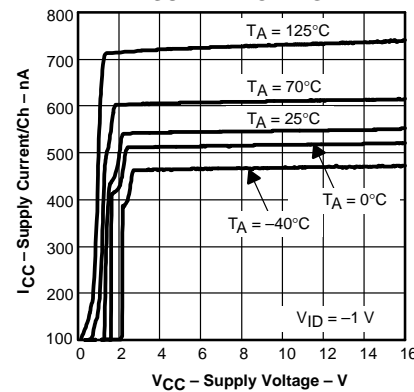

APPLICATIONS

- Portable Battery Monitoring
- Consumer Medical Electronics
- Security Detection Systems

DESCRIPTION

The TLV370x is Texas Instruments' first family of nanopower comparators with only 560 nA per channel supply current, which make this device ideal for battery power and wireless handset applications.

The TLV370x has a minimum operating supply voltage of 2.7 V over the extended industrial temperature range ($T_A = -40^{\circ}\text{C}$ to 125°C), while having an input common-mode range of -0.1 to $V_{CC} + 5\text{ V}$. The low supply current makes it an ideal choice for battery powered portable applications where quiescent current is the primary concern. Reverse battery protection guards the amplifier from an over-current condition due to improper battery installation. For harsh environments, the inputs can be taken 5 V above the positive supply rail without damage to the device.

high side voltage sense circuit

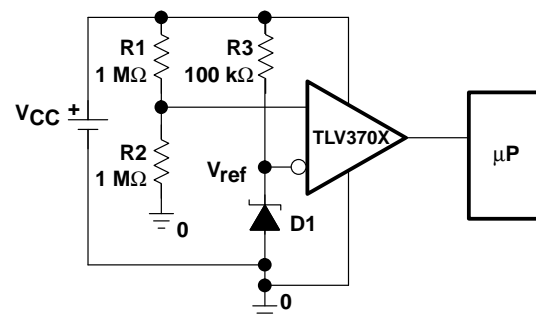

Please be aware that an important notice concerning availability, standard warranty, and use in critical applications of Texas Instruments semiconductor products and disclaimers thereto appears at the end of this data sheet.

A SELECTION OF OUTPUT COMPARATORST

DEVICE	V _{CC} (V)	V _{IO} (μV)	I _{CC/Ch} (μA)	I _B (pA)	t _{PLH} (μs)	t _{PHL} (μs)	t _f (μs)	t _r (μs)	RAIL-TO-RAIL	OUTPUT STAGE
TLV370x	2.5 – 16	250	0.56	80	56	83	22	8	I	PP
TLV340x	2.5 – 16	250	0.47	80	55	30	5	–	I	OD
TLC3702/4	3 – 16	1200	9	5	1.1	0.65	0.5	0.125	–	PP
TLC393/339	3 – 16	1400	11	5	1.1	0.55	0.22	–	–	OD
TLC372/4	3 – 16	1000	75	5	0.65	0.65	–	–	–	OD

† All specifications are typical values measured at 5 V.

TLV3701 AVAILABLE OPTIONS

T _A	V _{IO} max AT 25°C	PACKAGED DEVICES			
		SMALL OUTLINE (D)†	SOT-23 (DBV)‡	SYMBOL	PLASTIC DIP (P)
0°C to 70°C	5000 μV	TLV3701CD	TLV3701CDBV	VBCC	—
–40°C to 125°C		TLV3701ID	TLV3701IDBV	VBCI	TLV3701IP

† This package is available taped and reeled. To order this packaging option, add an R suffix to the part number (e.g., TLV3701CDR).

‡ This package is only available taped and reeled. For standard quantities (3000 pieces per reel), add an R suffix (i.e., TLV3701CDBVR). For small quantities (250 pieces per mini-reel), add a T suffix to the part number (e.g., TLV3701CDBVT).

TLV3702 AVAILABLE OPTIONS

T _A	V _{IO} max AT 25°C	PACKAGED DEVICES			
		SMALL OUTLINE (D)†	MSOP (DGK)†	SYMBOL	PLASTIC DIP (P)
0°C to 70°C	5000 μV	TLV3702CD	TLV3702CDGK	xxTIAKC	—
–40°C to 125°C		TLV3702ID	TLV3702IDGK	xxTIAKD	TLV3702IP

† This package is available taped and reeled. To order this packaging option, add an R suffix to the part number (e.g., TLV3702CDR).

TLV3704 AVAILABLE OPTIONS

T _A	V _{IO} max AT 25°C	PACKAGED DEVICES		
		SMALL OUTLINE (D)†	PLASTIC DIP (N)	TSSOP (PW)
0°C to 70°C	5000 μV	TLV3704CD	—	TLV3704CPW
–40°C to 125°C		TLV3704ID	TLV3704IN	TLV3704IPW

† This package is available taped and reeled. To order this packaging option, add an R suffix to the part number (e.g., TLV3704CDR).

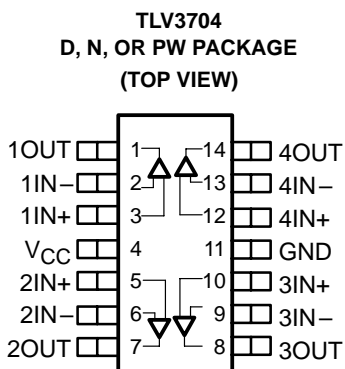
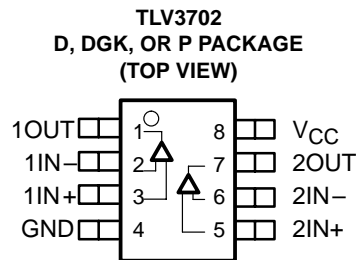
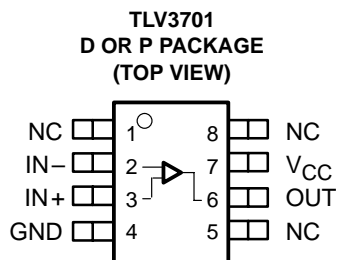
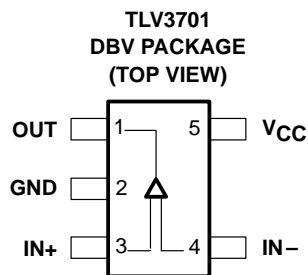

absolute maximum ratings over operating free-air temperature range (unless otherwise noted)†

Supply voltage, V_{CC} (see Note 1)	17 V
Differential input voltage, V_{ID}	± 20 V
Input voltage range, V_I (see Notes 1 and 2)	0 to $V_{CC} + 5$ V
Input current range, I_I	± 10 mA
Output current range, I_O	± 10 mA
Continuous total power dissipation	See Dissipation Rating Table
Operating free-air temperature range, T_A : C suffix	0°C to 70°C
I suffix	-40°C to 125°C
Maximum junction temperature, T_J	150°C
Storage temperature range, T_{stg}	-65°C to 150°C
Lead temperature 1,6 mm (1/16 inch) from case for 10 seconds	260°C

† Stresses beyond those listed under "absolute maximum ratings" may cause permanent damage to the device. These are stress ratings only, and functional operation of the device at these or any other conditions beyond those indicated under "recommended operating conditions" is not implied. Exposure to absolute-maximum-rated conditions for extended periods may affect device reliability.

- NOTES: 1. All voltage values, except differential voltages, are with respect to GND.
 2. Input voltage range is limited to 20 V max or $V_{CC} + 5$ V, whichever is smaller.

DISSIPATION RATING TABLE

PACKAGE	θ_{JC} (°C/W)	θ_{JA} (°C/W)	$T_A \leq 25^\circ\text{C}$ POWER RATING	$T_A = 125^\circ\text{C}$ POWER RATING
D (8)	38.3	176	710 mW	142 mW
D (14)	26.9	122.6	1022 mW	204.4 mW
DBV (5)	55	324.1	385 mW	77.1 mW
DGK (8)	54.2	259.9	481 mW	96.2 mW
N (14)	32	78	1600 mW	320.5 mW
P (8)	41	104	1200 mW	240.4 mW
PW (14)	29.3	173.6	720 mW	144 mW

recommended operating conditions

			MIN	MAX	UNIT
Supply voltage, V_{CC}	Single supply	C-suffix	2.5	16	V
		I-suffix	2.7	16	
	Split supply	C-suffix	± 1.25	± 8	
		I-suffix	± 1.35	± 8	
Common-mode input voltage range, V_{ICR}			-0.1	$V_{CC}+5$	V
Operating free-air temperature, T_A	C-suffix		0	70	°C
	I-suffix		-40	125	

electrical characteristics at specified operating free-air temperature, $V_{CC} = 2.7\text{ V}, 5\text{ V}, 15\text{ V}$ (unless otherwise noted)

dc performance

PARAMETER	TEST CONDITIONS	T_A †	MIN	TYP	MAX	UNIT
V_{IO} Input offset voltage	$V_{IC} = V_{CC}/2, R_S = 50\ \Omega$	25°C		250	5000	μV
		Full range			7000	
α_{VIO} Offset voltage drift		25°C		3		$\mu\text{V}/^\circ\text{C}$
CMRR Common-mode rejection ratio	$V_{IC} = 0\text{ to }2.7\text{ V}, R_S = 50\ \Omega$	25°C	55	72		dB
		Full range	50			
	$V_{IC} = 0\text{ to }5\text{ V}, R_S = 50\ \Omega$	25°C	60	76		
		Full range	55			
	$V_{IC} = 0\text{ to }15\text{ V}, R_S = 50\ \Omega$	25°C	65	88		
		Full range	60			
A_{VD} Large-signal differential voltage amplification		25°C		1000		V/mV

† Full range is 0°C to 70°C for C suffix and -40°C to 125°C for I suffix. If not specified, full range is -40°C to 125°C.

input/output characteristics

PARAMETER	TEST CONDITIONS	T_A †	MIN	TYP	MAX	UNIT
I_{IO} Input offset current	$V_{IC} = V_{CC}/2, R_S = 50\ \Omega$	25°C		20	100	pA
		Full range			1000	
I_{IB} Input bias current		25°C		80	250	pA
		Full range			1500	
$r_{i(d)}$ Differential input resistance		25°C		300		M Ω
V_{OH} High-level output voltage	$V_{IC} = V_{CC}/2, I_{OH} = 2\ \mu\text{A}, V_{ID} = 1\text{ V}$	25°C		$V_{CC} - 0.08$		mV
	$V_{IC} = V_{CC}/2, I_{OH} = -50\ \mu\text{A}, V_{ID} = 1\text{ V}$	25°C		$V_{CC} - 320$		
		Full range			$V_{CC} - 450$	
V_{OL} Low-level output voltage	$V_{IC} = V_{CC}/2, I_{OH} = 2\ \mu\text{A}, V_{ID} = -1\text{ V}$	25°C		8		mV
	$V_{IC} = V_{CC}/2, I_{OH} = 50\ \mu\text{A}, V_{ID} = -1\text{ V}$	25°C		80	200	
		Full range				

† Full range is 0°C to 70°C for C suffix and -40°C to 125°C for I suffix. If not specified, full range is -40°C to 125°C.

power supply

PARAMETER	TEST CONDITIONS	T_A †	MIN	TYP	MAX	UNIT	
I_{CC} Supply current (per channel)	Output state high	25°C		560	800	nA	
		Full range			1000		
PSRR Power supply rejection ratio	$V_{IC} = V_{CC}/2\text{ V},$ No load	$V_{CC} = 2.7\text{ V to }5\text{ V}$	25°C	75	100	dB	
			Full range	70			
		$V_{CC} = 5\text{ V to }15\text{ V}$	25°C	85	105		
			Full range	80			

† Full range is 0°C to 70°C for C suffix and -40°C to 125°C for I suffix. If not specified, full range is -40°C to 125°C.

switching characteristics at recommended operating conditions, $V_{CC} = 2.7\text{ V}, 5\text{ V}, 15\text{ V}, T_A = 25^\circ\text{C}$ (unless otherwise noted)

PARAMETER		TEST CONDITIONS	MIN	TYP	MAX	UNIT
$t_{(PLH)}$	Propagation response time, low-to-high-level output (see Note 3)	f = 10 kHz, VSTEP = 100 mV, C _L = 10 pF, V _{CC} = 2.7 V	Overdrive = 2 mV		240	μs
			Overdrive = 10 mV		64	
			Overdrive = 50 mV		36	
$t_{(PHL)}$	Propagation response time, high-to-low-level output (see Note 3)		Overdrive = 2 mV		167	
			Overdrive = 10 mV		67	
			Overdrive = 50 mV		37	
t_r	Rise time	C _L = 10 pF, V _{CC} = 2.7 V		7	μs	
t_f	Fall time	C _L = 10 pF, V _{CC} = 2.7 V		9	μs	

NOTE 3: The response time specified is the interval between the input step function and the instant when the output crosses 1.4 V. Propagation responses are longer at higher supply voltages, refer to Figures 12–17 for further details.

TYPICAL CHARACTERISTICS

Table of Graphs

			FIGURE
Input bias/offset current		vs Free-air temperature	1
Open collector leakage current		vs Free-air temperature	2
V _{OL}	Low-level output voltage	vs Low-level output current	3, 5, 7
V _{OH}	High-level output voltage	vs High-level output current	4, 6, 8
I _{CC}	Supply current	vs Supply voltage	9
		vs Free-air temperature	10
	Output fall time/rise time	vs Supply voltage	11
	Low-to-high level output response for various input overdrives		12, 14, 16
	High-to-low level output response for various input overdrives		13, 15, 17

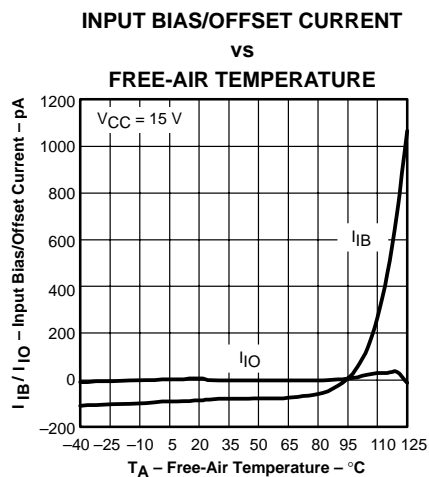

Figure 1

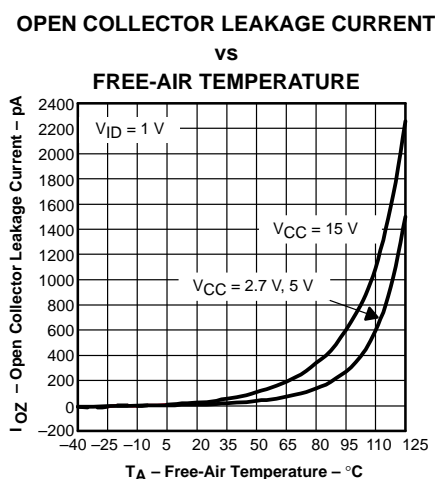

Figure 2

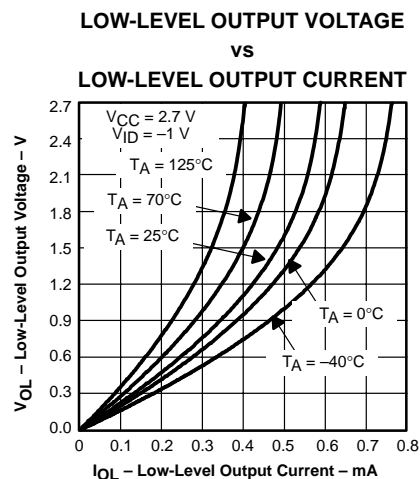

Figure 3

TYPICAL CHARACTERISTICS

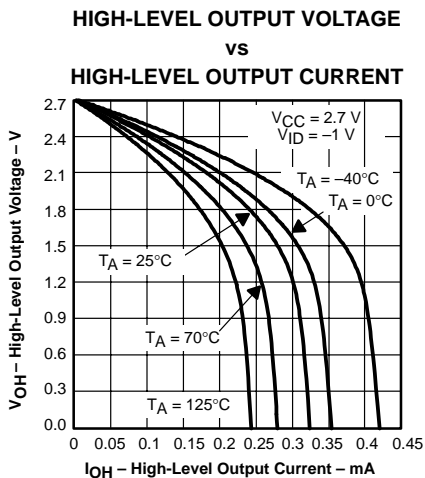

Figure 4

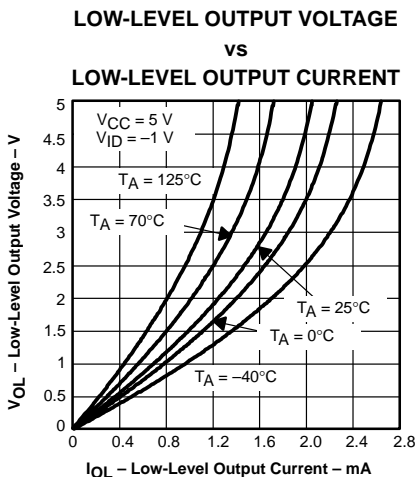

Figure 5

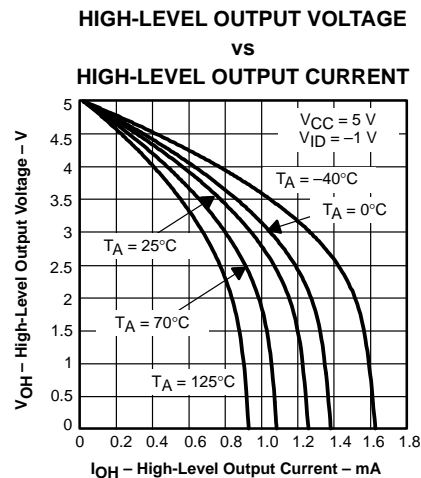

Figure 6

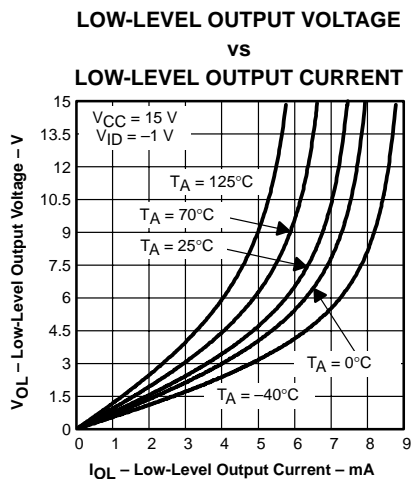

Figure 7

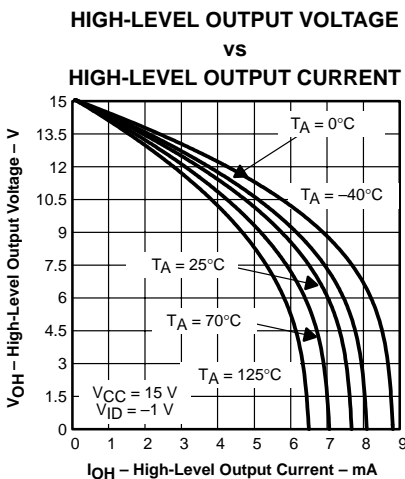

Figure 8

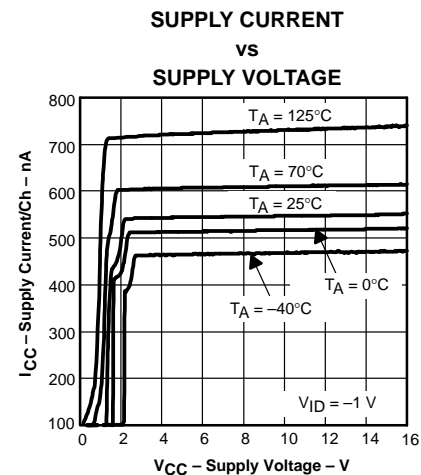

Figure 9

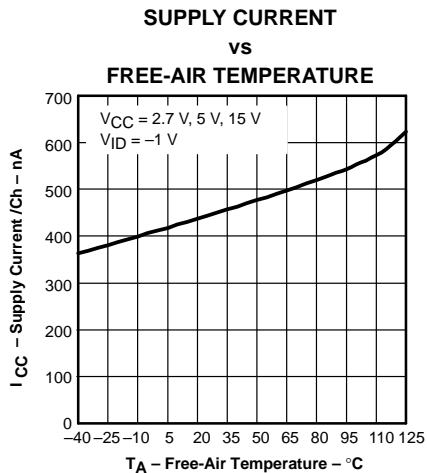

Figure 10

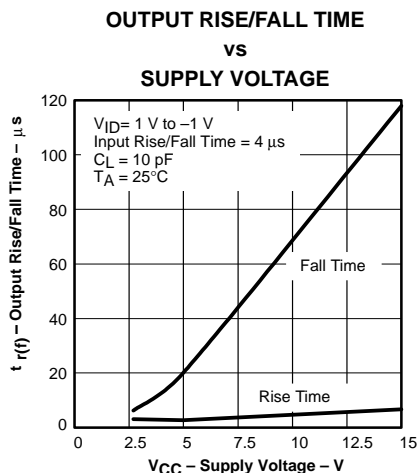

Figure 11

TYPICAL CHARACTERISTICS

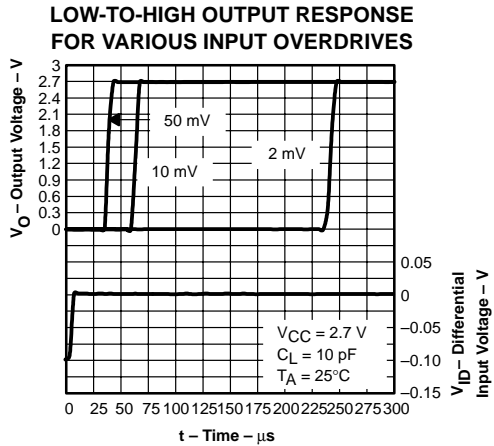

Figure 12

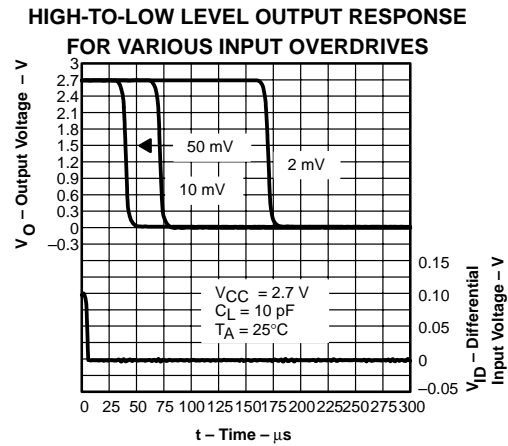

Figure 13

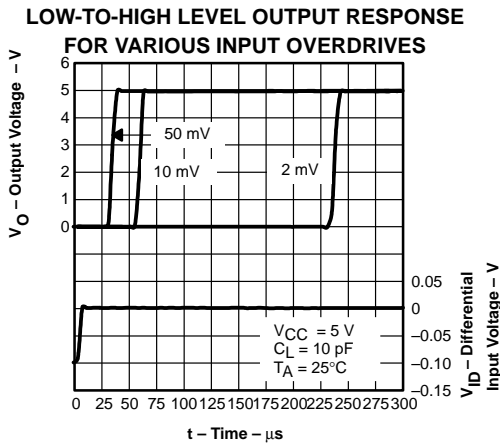

Figure 14

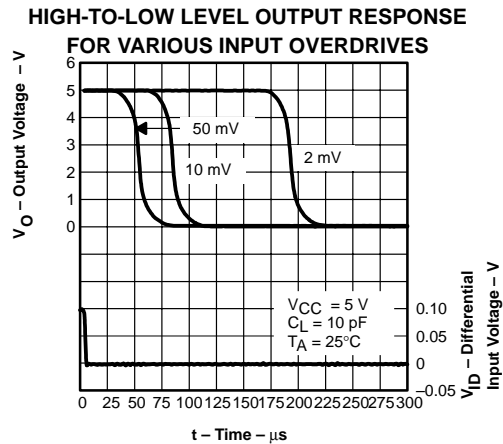

Figure 15

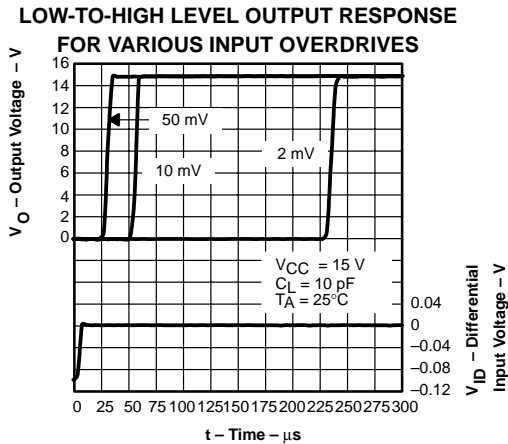

Figure 16

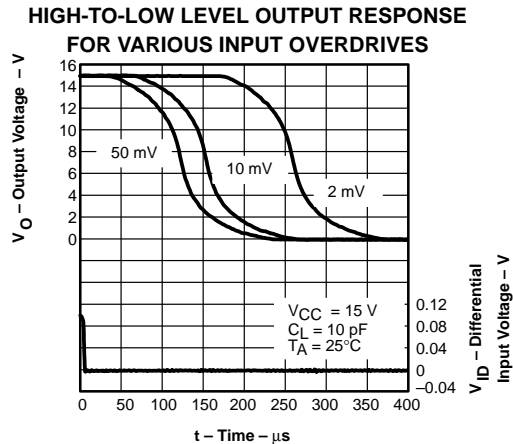

Figure 17

PACKAGING INFORMATION

Orderable Device	Status (1)	Package Type	Package Drawing	Pins	Package Qty	Eco Plan (2)	Lead/Ball Finish (6)	MSL Peak Temp (3)	Op Temp (°C)	Device Marking (4/5)	Samples
TLV3701CD	ACTIVE	SOIC	D	8	75	Green (RoHS & no Sb/Br)	CU NIPDAU	Level-1-260C-UNLIM	0 to 70	3701C	Samples
TLV3701CDBVR	ACTIVE	SOT-23	DBV	5	3000	Green (RoHS & no Sb/Br)	CU NIPDAU	Level-1-260C-UNLIM	0 to 70	VBCC	Samples
TLV3701CDBVRG4	ACTIVE	SOT-23	DBV	5	3000	Green (RoHS & no Sb/Br)	CU NIPDAU	Level-1-260C-UNLIM	0 to 70	VBCC	Samples
TLV3701CDBVBT	ACTIVE	SOT-23	DBV	5	250	Green (RoHS & no Sb/Br)	CU NIPDAU	Level-1-260C-UNLIM	0 to 70	VBCC	Samples
TLV3701CDBVTG4	ACTIVE	SOT-23	DBV	5	250	Green (RoHS & no Sb/Br)	CU NIPDAU	Level-1-260C-UNLIM	0 to 70	VBCC	Samples
TLV3701ID	ACTIVE	SOIC	D	8	75	Green (RoHS & no Sb/Br)	CU NIPDAU	Level-1-260C-UNLIM	-40 to 125	3701I	Samples
TLV3701IDBVR	ACTIVE	SOT-23	DBV	5	3000	Green (RoHS & no Sb/Br)	CU NIPDAU	Level-1-260C-UNLIM	-40 to 125	VBCI	Samples
TLV3701IDBVRG4	ACTIVE	SOT-23	DBV	5	3000	Green (RoHS & no Sb/Br)	CU NIPDAU	Level-1-260C-UNLIM	-40 to 125	VBCI	Samples
TLV3701IDBVT	ACTIVE	SOT-23	DBV	5	250	Green (RoHS & no Sb/Br)	CU NIPDAU	Level-1-260C-UNLIM	-40 to 125	VBCI	Samples
TLV3701IDBVTG4	ACTIVE	SOT-23	DBV	5	250	Green (RoHS & no Sb/Br)	CU NIPDAU	Level-1-260C-UNLIM	-40 to 125	VBCI	Samples
TLV3701IDG4	ACTIVE	SOIC	D	8	75	Green (RoHS & no Sb/Br)	CU NIPDAU	Level-1-260C-UNLIM	-40 to 125	3701I	Samples
TLV3701IDR	ACTIVE	SOIC	D	8	2500	Green (RoHS & no Sb/Br)	CU NIPDAU	Level-1-260C-UNLIM	-40 to 125	3701I	Samples
TLV3701IP	ACTIVE	PDIP	P	8	50	Pb-Free (RoHS)	CU NIPDAU	N / A for Pkg Type	-40 to 125	TLV3701I	Samples
TLV3701IPE4	ACTIVE	PDIP	P	8	50	Pb-Free (RoHS)	CU NIPDAU	N / A for Pkg Type	-40 to 125	TLV3701I	Samples
TLV3702CD	ACTIVE	SOIC	D	8	75	Green (RoHS & no Sb/Br)	CU NIPDAU	Level-1-260C-UNLIM	0 to 70	3702C	Samples
TLV3702CDG4	ACTIVE	SOIC	D	8	75	Green (RoHS & no Sb/Br)	CU NIPDAU	Level-1-260C-UNLIM	0 to 70	3702C	Samples
TLV3702CDGK	ACTIVE	VSSOP	DGK	8	80	Green (RoHS & no Sb/Br)	CU NIPDAU	Level-1-260C-UNLIM	0 to 70	AKC	Samples

Orderable Device	Status (1)	Package Type	Package Drawing	Pins	Package Qty	Eco Plan (2)	Lead/Ball Finish (6)	MSL Peak Temp (3)	Op Temp (°C)	Device Marking (4/5)	Samples
TLV3702CDGKG4	ACTIVE	VSSOP	DGK	8	80	Green (RoHS & no Sb/Br)	CU NIPDAU	Level-1-260C-UNLIM	0 to 70	AKC	Samples
TLV3702CDGKR	ACTIVE	VSSOP	DGK	8	2500	Green (RoHS & no Sb/Br)	CU NIPDAU	Level-1-260C-UNLIM	0 to 70	AKC	Samples
TLV3702CDGKRG4	ACTIVE	VSSOP	DGK	8	2500	Green (RoHS & no Sb/Br)	CU NIPDAU	Level-1-260C-UNLIM	0 to 70	AKC	Samples
TLV3702ID	ACTIVE	SOIC	D	8	75	Green (RoHS & no Sb/Br)	CU NIPDAU	Level-1-260C-UNLIM	-40 to 125	3702I	Samples
TLV3702IDG4	ACTIVE	SOIC	D	8	75	Green (RoHS & no Sb/Br)	CU NIPDAU	Level-1-260C-UNLIM	-40 to 125	3702I	Samples
TLV3702IDGK	ACTIVE	VSSOP	DGK	8	80	Green (RoHS & no Sb/Br)	CU NIPDAU	Level-1-260C-UNLIM	-40 to 125	AKD	Samples
TLV3702IDGKG4	ACTIVE	VSSOP	DGK	8	80	Green (RoHS & no Sb/Br)	CU NIPDAU	Level-1-260C-UNLIM	-40 to 125	AKD	Samples
TLV3702IDGKR	ACTIVE	VSSOP	DGK	8	2500	Green (RoHS & no Sb/Br)	CU NIPDAU	Level-1-260C-UNLIM	-40 to 125	AKD	Samples
TLV3702IDGKRG4	ACTIVE	VSSOP	DGK	8	2500	Green (RoHS & no Sb/Br)	CU NIPDAU	Level-1-260C-UNLIM	-40 to 125	AKD	Samples
TLV3702IDR	ACTIVE	SOIC	D	8	2500	Green (RoHS & no Sb/Br)	CU NIPDAU	Level-1-260C-UNLIM	-40 to 125	3702I	Samples
TLV3702IDRG4	ACTIVE	SOIC	D	8	2500	Green (RoHS & no Sb/Br)	CU NIPDAU	Level-1-260C-UNLIM	-40 to 125	3702I	Samples
TLV3702IP	ACTIVE	PDIP	P	8	50	Pb-Free (RoHS)	CU NIPDAU	N / A for Pkg Type	-40 to 125	TLV3702I	Samples
TLV3702IPE4	ACTIVE	PDIP	P	8	50	Pb-Free (RoHS)	CU NIPDAU	N / A for Pkg Type	-40 to 125	TLV3702I	Samples
TLV3704CD	ACTIVE	SOIC	D	14	50	Green (RoHS & no Sb/Br)	CU NIPDAU	Level-1-260C-UNLIM	0 to 70	3704C	Samples
TLV3704CDG4	ACTIVE	SOIC	D	14	50	Green (RoHS & no Sb/Br)	CU NIPDAU	Level-1-260C-UNLIM	0 to 70	3704C	Samples
TLV3704CPW	ACTIVE	TSSOP	PW	14	90	Green (RoHS & no Sb/Br)	CU NIPDAU	Level-1-260C-UNLIM	0 to 70	3704C	Samples
TLV3704ID	ACTIVE	SOIC	D	14	50	Green (RoHS & no Sb/Br)	CU NIPDAU	Level-1-260C-UNLIM	-40 to 125	3704I	Samples
TLV3704IDG4	ACTIVE	SOIC	D	14	50	Green (RoHS & no Sb/Br)	CU NIPDAU	Level-1-260C-UNLIM	-40 to 125	3704I	Samples

Orderable Device	Status (1)	Package Type	Package Drawing	Pins	Package Qty	Eco Plan (2)	Lead/Ball Finish (6)	MSL Peak Temp (3)	Op Temp (°C)	Device Marking (4/5)	Samples
TLV3704IDR	ACTIVE	SOIC	D	14	2500	Green (RoHS & no Sb/Br)	CU NIPDAU	Level-1-260C-UNLIM	-40 to 125	3704I	Samples
TLV3704IDRG4	ACTIVE	SOIC	D	14	2500	Green (RoHS & no Sb/Br)	CU NIPDAU	Level-1-260C-UNLIM	-40 to 125	3704I	Samples
TLV3704IN	ACTIVE	PDIP	N	14	25	Pb-Free (RoHS)	CU NIPDAU	N / A for Pkg Type	-40 to 125	TLV3704I	Samples
TLV3704IPW	ACTIVE	TSSOP	PW	14	90	Green (RoHS & no Sb/Br)	CU NIPDAU	Level-1-260C-UNLIM	-40 to 125	3704I	Samples
TLV3704IPWG4	ACTIVE	TSSOP	PW	14	90	Green (RoHS & no Sb/Br)	CU NIPDAU	Level-1-260C-UNLIM	-40 to 125	3704I	Samples
TLV3704IPWR	ACTIVE	TSSOP	PW	14	2000	Green (RoHS & no Sb/Br)	CU NIPDAU	Level-1-260C-UNLIM	-40 to 125	3704I	Samples
TLV3704IPWRG4	ACTIVE	TSSOP	PW	14	2000	Green (RoHS & no Sb/Br)	CU NIPDAU	Level-1-260C-UNLIM	-40 to 125	3704I	Samples

(1) The marketing status values are defined as follows:

ACTIVE: Product device recommended for new designs.

LIFEBUY: TI has announced that the device will be discontinued, and a lifetime-buy period is in effect.

NRND: Not recommended for new designs. Device is in production to support existing customers, but TI does not recommend using this part in a new design.

PREVIEW: Device has been announced but is not in production. Samples may or may not be available.

OBSELETE: TI has discontinued the production of the device.

(2) Eco Plan - The planned eco-friendly classification: Pb-Free (RoHS), Pb-Free (RoHS Exempt), or Green (RoHS & no Sb/Br) - please check <http://www.ti.com/productcontent> for the latest availability information and additional product content details.

TBD: The Pb-Free/Green conversion plan has not been defined.

Pb-Free (RoHS): TI's terms "Lead-Free" or "Pb-Free" mean semiconductor products that are compatible with the current RoHS requirements for all 6 substances, including the requirement that lead not exceed 0.1% by weight in homogeneous materials. Where designed to be soldered at high temperatures, TI Pb-Free products are suitable for use in specified lead-free processes.

Pb-Free (RoHS Exempt): This component has a RoHS exemption for either 1) lead-based flip-chip solder bumps used between the die and package, or 2) lead-based die adhesive used between the die and leadframe. The component is otherwise considered Pb-Free (RoHS compatible) as defined above.

Green (RoHS & no Sb/Br): TI defines "Green" to mean Pb-Free (RoHS compatible), and free of Bromine (Br) and Antimony (Sb) based flame retardants (Br or Sb do not exceed 0.1% by weight in homogeneous material)

(3) MSL, Peak Temp. - The Moisture Sensitivity Level rating according to the JEDEC industry standard classifications, and peak solder temperature.

(4) There may be additional marking, which relates to the logo, the lot trace code information, or the environmental category on the device.

(5) Multiple Device Markings will be inside parentheses. Only one Device Marking contained in parentheses and separated by a "-" will appear on a device. If a line is indented then it is a continuation of the previous line and the two combined represent the entire Device Marking for that device.

⁽⁶⁾ Lead/Ball Finish - Orderable Devices may have multiple material finish options. Finish options are separated by a vertical ruled line. Lead/Ball Finish values may wrap to two lines if the finish value exceeds the maximum column width.

Important Information and Disclaimer: The information provided on this page represents TI's knowledge and belief as of the date that it is provided. TI bases its knowledge and belief on information provided by third parties, and makes no representation or warranty as to the accuracy of such information. Efforts are underway to better integrate information from third parties. TI has taken and continues to take reasonable steps to provide representative and accurate information but may not have conducted destructive testing or chemical analysis on incoming materials and chemicals. TI and TI suppliers consider certain information to be proprietary, and thus CAS numbers and other limited information may not be available for release.

In no event shall TI's liability arising out of such information exceed the total purchase price of the TI part(s) at issue in this document sold by TI to Customer on an annual basis.

OTHER QUALIFIED VERSIONS OF TLV3701, TLV3702 :

- Automotive: [TLV3701-Q1](#), [TLV3702-Q1](#)
- Enhanced Product: [TLV3701-EP](#)

NOTE: Qualified Version Definitions:

- Automotive - Q100 devices qualified for high-reliability automotive applications targeting zero defects
- Enhanced Product - Supports Defense, Aerospace and Medical Applications

TAPE AND REEL INFORMATION

QUADRANT ASSIGNMENTS FOR PIN 1 ORIENTATION IN TAPE

*All dimensions are nominal

Device	Package Type	Package Drawing	Pins	SPQ	Reel Diameter (mm)	Reel Width W1 (mm)	A0 (mm)	B0 (mm)	K0 (mm)	P1 (mm)	W (mm)	Pin1 Quadrant
TLV3701CDBVR	SOT-23	DBV	5	3000	180.0	9.0	3.15	3.2	1.4	4.0	8.0	Q3
TLV3701CDBVT	SOT-23	DBV	5	250	180.0	9.0	3.15	3.2	1.4	4.0	8.0	Q3
TLV3701IDBVR	SOT-23	DBV	5	3000	180.0	9.0	3.15	3.2	1.4	4.0	8.0	Q3
TLV3701IDBVT	SOT-23	DBV	5	250	180.0	9.0	3.15	3.2	1.4	4.0	8.0	Q3
TLV3701IDR	SOIC	D	8	2500	330.0	12.4	6.4	5.2	2.1	8.0	12.0	Q1
TLV3702CDGKR	VSSOP	DGK	8	2500	330.0	12.4	5.3	3.4	1.4	8.0	12.0	Q1
TLV3702IDGKR	VSSOP	DGK	8	2500	330.0	12.4	5.3	3.4	1.4	8.0	12.0	Q1
TLV3702IDR	SOIC	D	8	2500	330.0	12.4	6.4	5.2	2.1	8.0	12.0	Q1
TLV3704IDR	SOIC	D	14	2500	330.0	16.4	6.5	9.0	2.1	8.0	16.0	Q1
TLV3704IPWR	TSSOP	PW	14	2000	330.0	12.4	6.9	5.6	1.6	8.0	12.0	Q1

TAPE AND REEL BOX DIMENSIONS

*All dimensions are nominal

Device	Package Type	Package Drawing	Pins	SPQ	Length (mm)	Width (mm)	Height (mm)
TLV3701CDBVR	SOT-23	DBV	5	3000	182.0	182.0	20.0
TLV3701CDBVT	SOT-23	DBV	5	250	182.0	182.0	20.0
TLV3701IDBVR	SOT-23	DBV	5	3000	182.0	182.0	20.0
TLV3701IDBVT	SOT-23	DBV	5	250	182.0	182.0	20.0
TLV3701IDR	SOIC	D	8	2500	340.5	338.1	20.6
TLV3702CDGKR	VSSOP	DGK	8	2500	358.0	335.0	35.0
TLV3702IDGKR	VSSOP	DGK	8	2500	358.0	335.0	35.0
TLV3702IDR	SOIC	D	8	2500	340.5	338.1	20.6
TLV3704IDR	SOIC	D	14	2500	333.2	345.9	28.6
TLV3704IPWR	TSSOP	PW	14	2000	367.0	367.0	35.0

P (R-PDIP-T8)

PLASTIC DUAL-IN-LINE PACKAGE

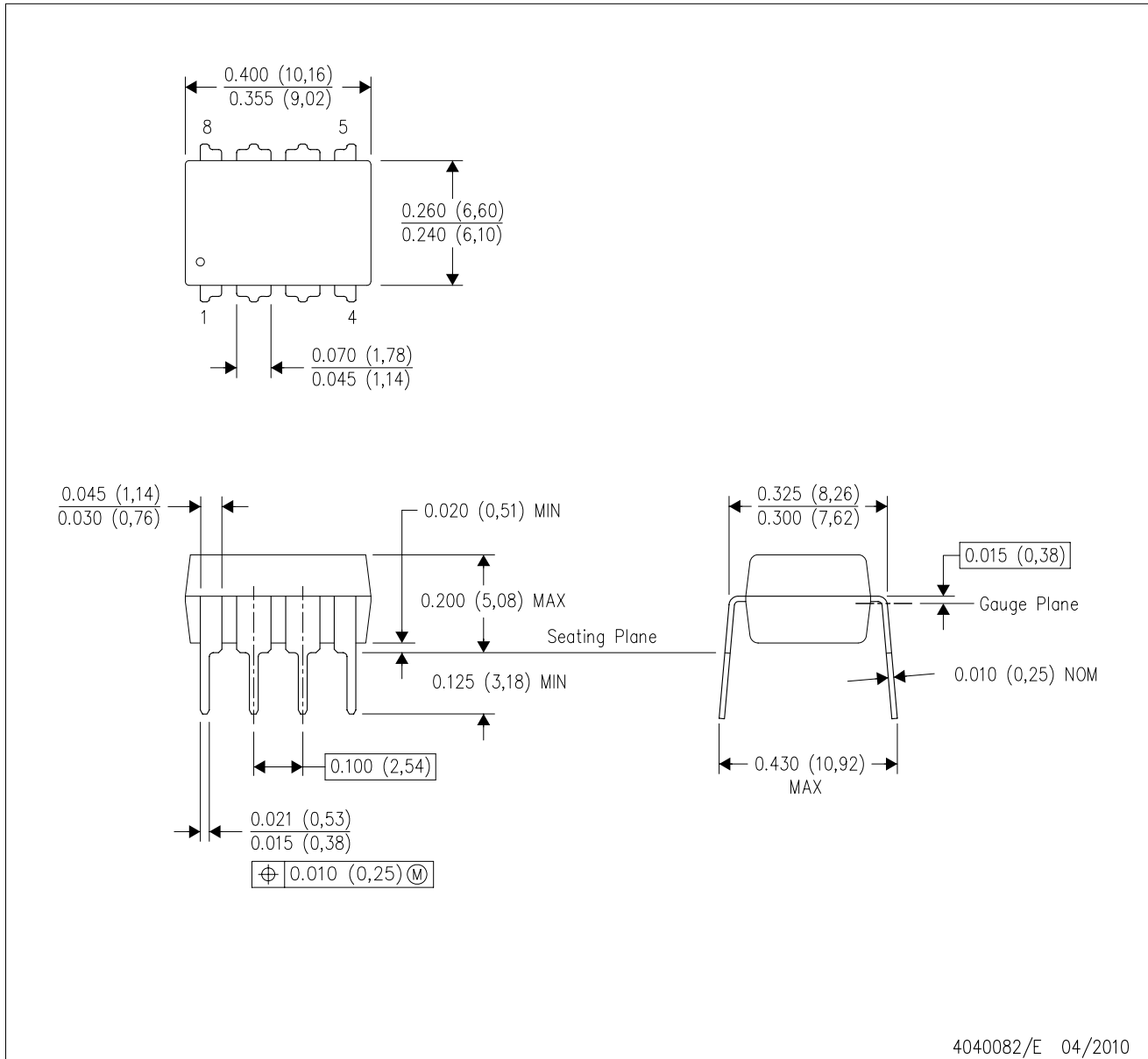

- NOTES:
- A. All linear dimensions are in inches (millimeters).
 - B. This drawing is subject to change without notice.
 - C. Falls within JEDEC MS-001 variation BA.

DBV (R-PDSO-G5)

PLASTIC SMALL-OUTLINE PACKAGE

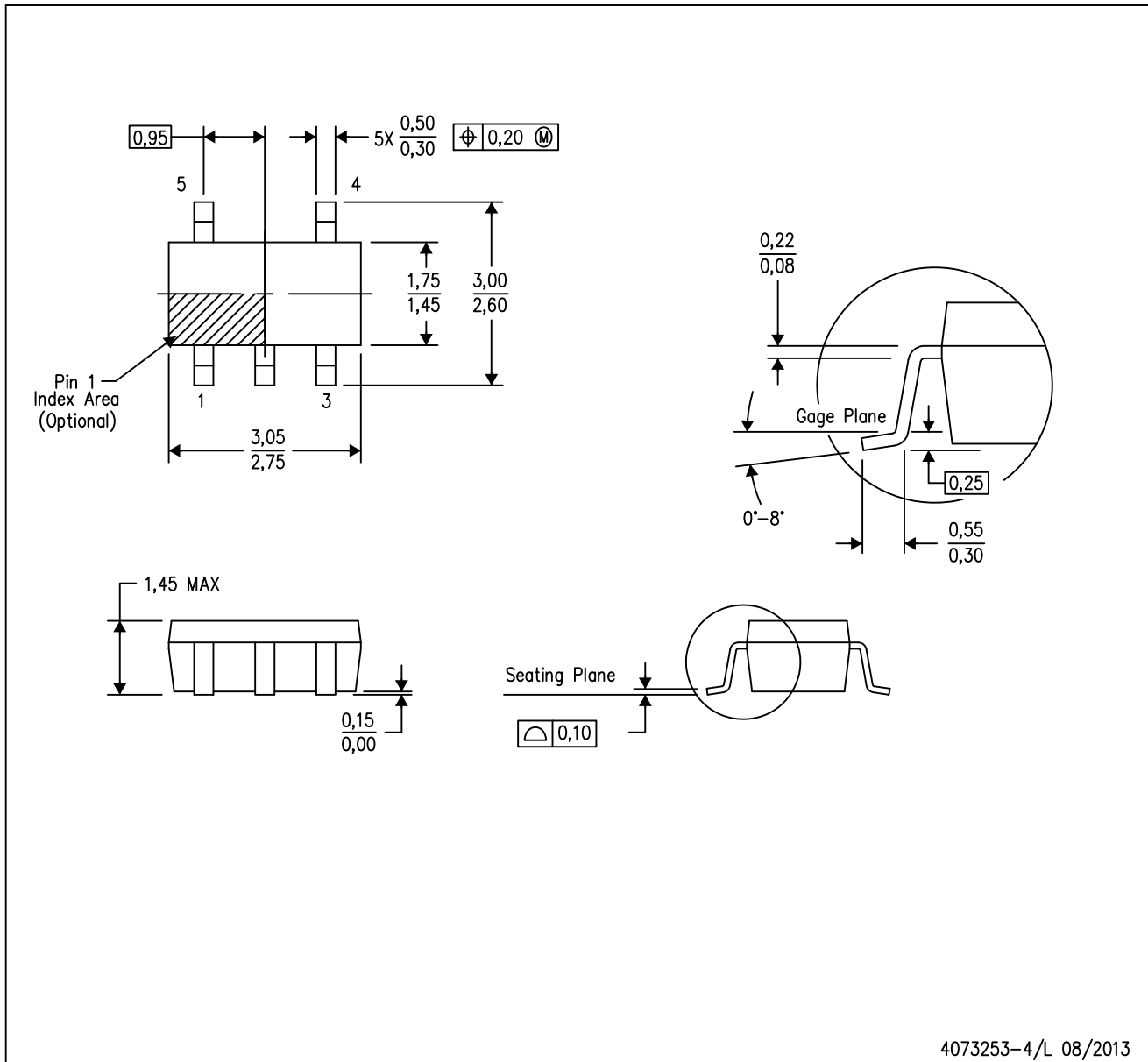

- NOTES:
- A. All linear dimensions are in millimeters.
 - B. This drawing is subject to change without notice.
 - C. Body dimensions do not include mold flash or protrusion. Mold flash and protrusion shall not exceed 0.15 per side.
 - D. Falls within JEDEC MO-178 Variation AA.

DBV (R-PDSO-G5)

PLASTIC SMALL OUTLINE



4209593-3/C 08/11

- NOTES:
- A. All linear dimensions are in millimeters.
 - B. This drawing is subject to change without notice.
 - C. Customers should place a note on the circuit board fabrication drawing not to alter the center solder mask defined pad.
 - D. Publication IPC-7351 is recommended for alternate designs.
 - E. Laser cutting apertures with trapezoidal walls and also rounding corners will offer better paste release. Customers should contact their board assembly site for stencil design recommendations. Example stencil design based on a 50% volumetric metal load solder paste. Refer to IPC-7525 for other stencil recommendations.

D (R-PDSO-G14)

PLASTIC SMALL OUTLINE



- NOTES:
- A. All linear dimensions are in millimeters.
 - B. This drawing is subject to change without notice.
 - C. Publication IPC-7351 is recommended for alternate designs.
 - D. Laser cutting apertures with trapezoidal walls and also rounding corners will offer better paste release. Customers should contact their board assembly site for stencil design recommendations. Refer to IPC-7525 for other stencil recommendations.
 - E. Customers should contact their board fabrication site for solder mask tolerances between and around signal pads.

PW (R-PDSO-G14)

PLASTIC SMALL OUTLINE



4040064-3/G 02/11

- NOTES:
- A. All linear dimensions are in millimeters. Dimensioning and tolerancing per ASME Y14.5M-1994.
 - B. This drawing is subject to change without notice.
 -  C. Body length does not include mold flash, protrusions, or gate burrs. Mold flash, protrusions, or gate burrs shall not exceed 0,15 each side.
 -  D. Body width does not include interlead flash. Interlead flash shall not exceed 0,25 each side.
 - E. Falls within JEDEC MO-153

PW (R-PDSO-G14)

PLASTIC SMALL OUTLINE

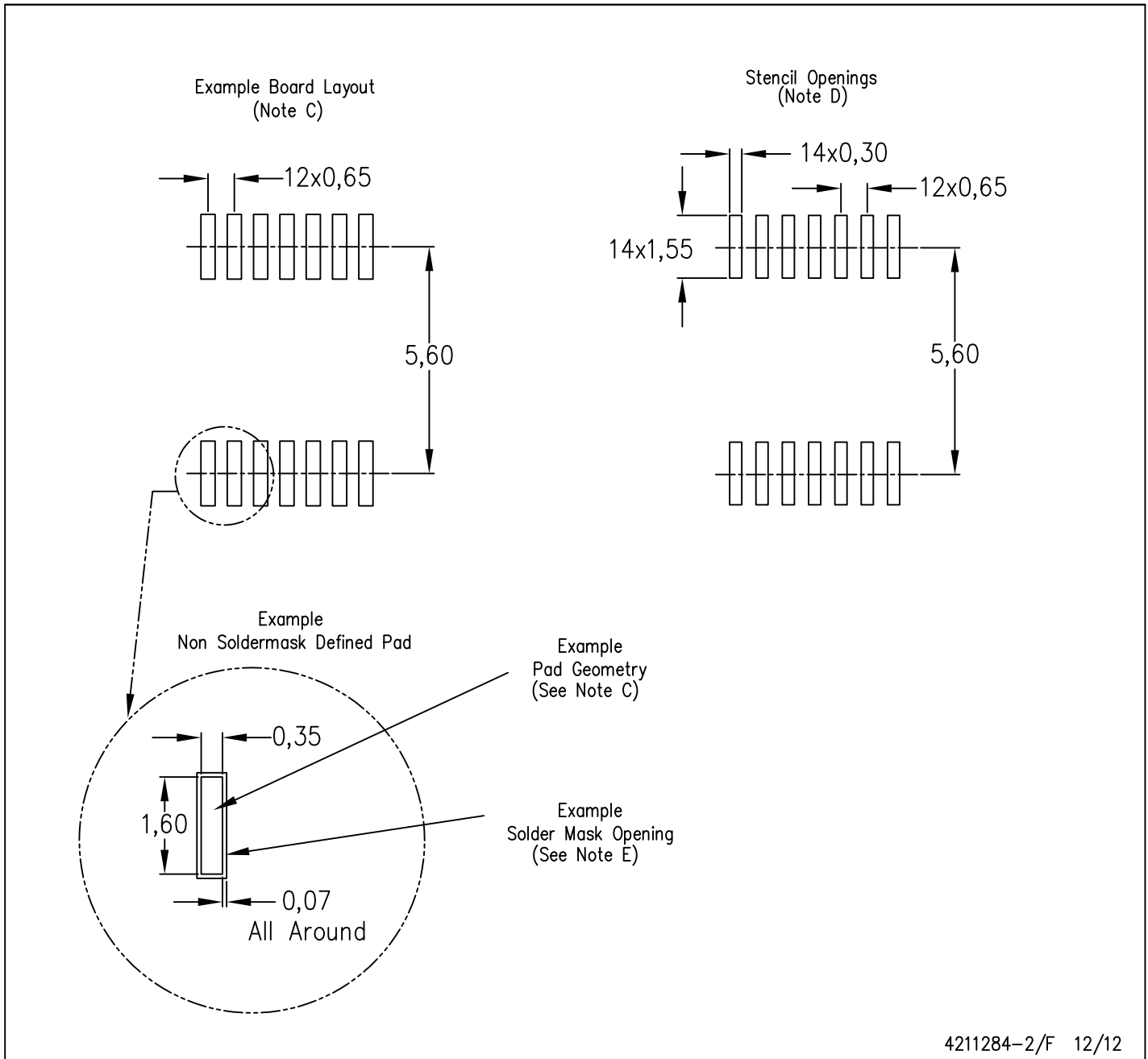

- NOTES:
- All linear dimensions are in millimeters.
 - This drawing is subject to change without notice.
 - Publication IPC-7351 is recommended for alternate designs.
 - Laser cutting apertures with trapezoidal walls and also rounding corners will offer better paste release. Customers should contact their board assembly site for stencil design recommendations. Refer to IPC-7525 for other stencil recommendations.
 - Customers should contact their board fabrication site for solder mask tolerances between and around signal pads.

D (R-PDSO-G8)

PLASTIC SMALL OUTLINE

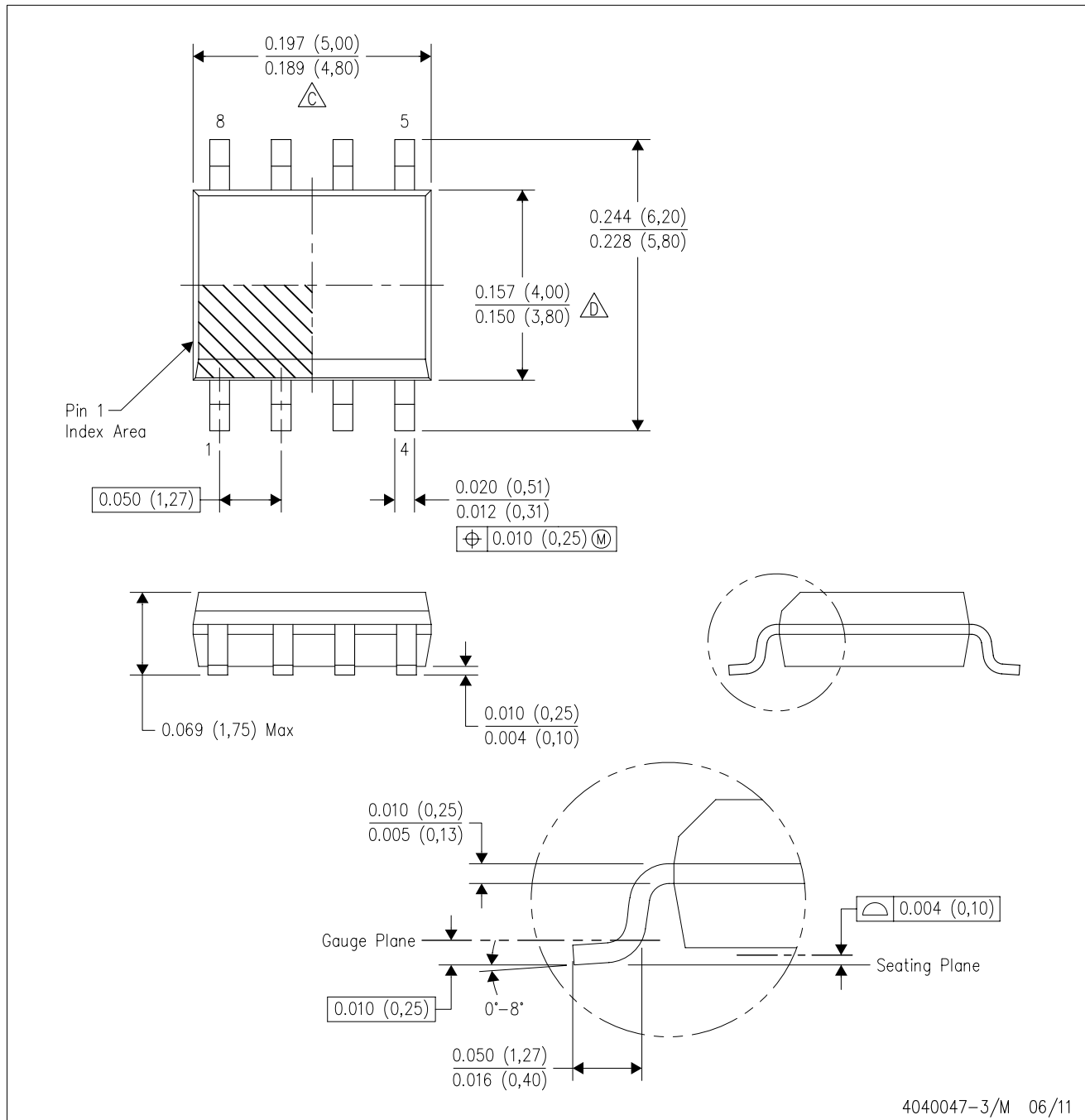

NOTES: A. All linear dimensions are in inches (millimeters).
 B. This drawing is subject to change without notice.
 C. Body length does not include mold flash, protrusions, or gate burrs. Mold flash, protrusions, or gate burrs shall not exceed 0.006 (0,15) each side.
 D. Body width does not include interlead flash. Interlead flash shall not exceed 0.017 (0,43) each side.
 E. Reference JEDEC MS-012 variation AA.

D (R-PDSO-G8)

PLASTIC SMALL OUTLINE

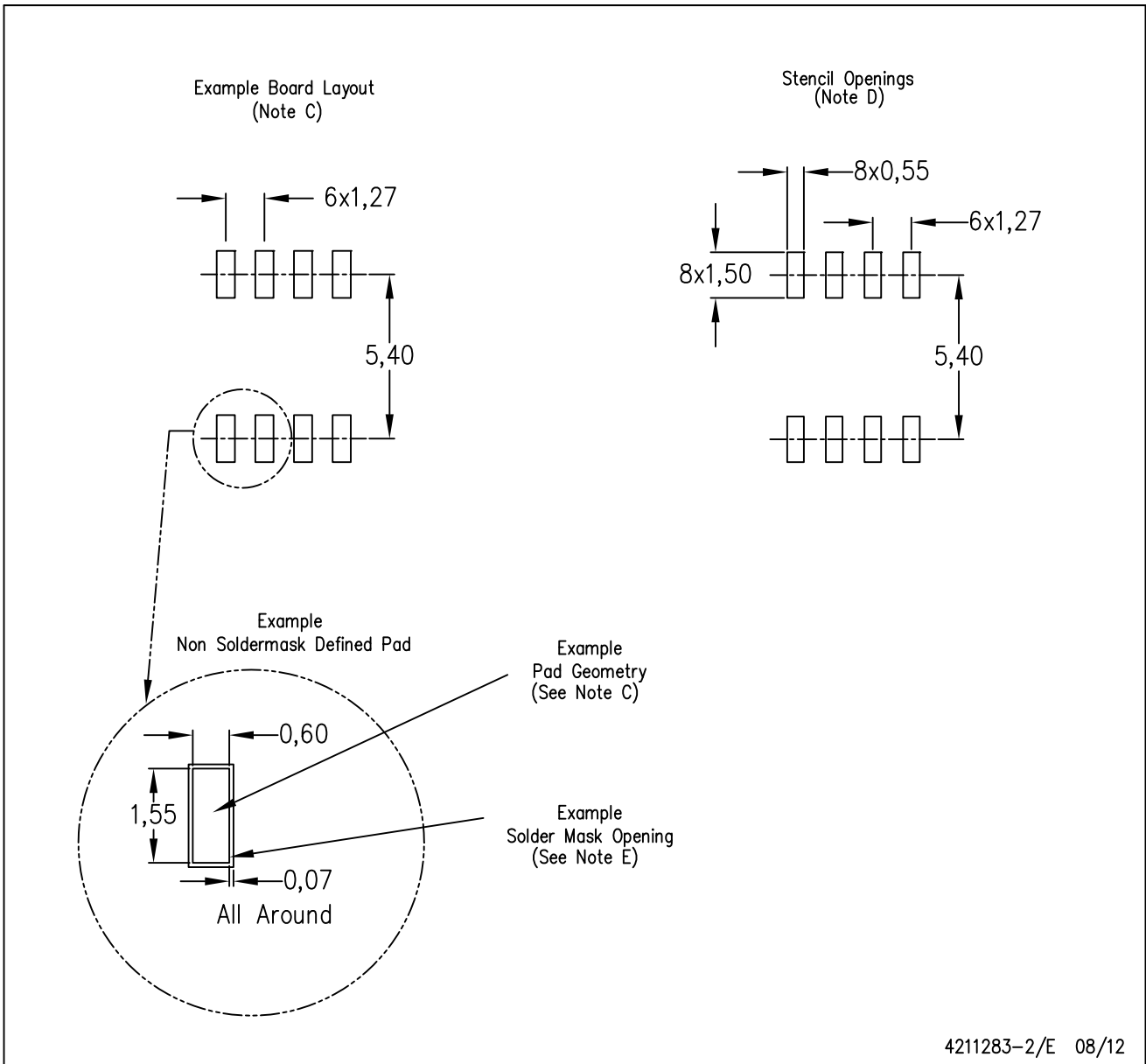

- NOTES:
- All linear dimensions are in millimeters.
 - This drawing is subject to change without notice.
 - Publication IPC-7351 is recommended for alternate designs.
 - Laser cutting apertures with trapezoidal walls and also rounding corners will offer better paste release. Customers should contact their board assembly site for stencil design recommendations. Refer to IPC-7525 for other stencil recommendations.
 - Customers should contact their board fabrication site for solder mask tolerances between and around signal pads.

IMPORTANT NOTICE

Texas Instruments Incorporated and its subsidiaries (TI) reserve the right to make corrections, enhancements, improvements and other changes to its semiconductor products and services per JESD46, latest issue, and to discontinue any product or service per JESD48, latest issue. Buyers should obtain the latest relevant information before placing orders and should verify that such information is current and complete. All semiconductor products (also referred to herein as "components") are sold subject to TI's terms and conditions of sale supplied at the time of order acknowledgment.

TI warrants performance of its components to the specifications applicable at the time of sale, in accordance with the warranty in TI's terms and conditions of sale of semiconductor products. Testing and other quality control techniques are used to the extent TI deems necessary to support this warranty. Except where mandated by applicable law, testing of all parameters of each component is not necessarily performed.

TI assumes no liability for applications assistance or the design of Buyers' products. Buyers are responsible for their products and applications using TI components. To minimize the risks associated with Buyers' products and applications, Buyers should provide adequate design and operating safeguards.

TI does not warrant or represent that any license, either express or implied, is granted under any patent right, copyright, mask work right, or other intellectual property right relating to any combination, machine, or process in which TI components or services are used. Information published by TI regarding third-party products or services does not constitute a license to use such products or services or a warranty or endorsement thereof. Use of such information may require a license from a third party under the patents or other intellectual property of the third party, or a license from TI under the patents or other intellectual property of TI.

Reproduction of significant portions of TI information in TI data books or data sheets is permissible only if reproduction is without alteration and is accompanied by all associated warranties, conditions, limitations, and notices. TI is not responsible or liable for such altered documentation. Information of third parties may be subject to additional restrictions.

Resale of TI components or services with statements different from or beyond the parameters stated by TI for that component or service voids all express and any implied warranties for the associated TI component or service and is an unfair and deceptive business practice. TI is not responsible or liable for any such statements.

Buyer acknowledges and agrees that it is solely responsible for compliance with all legal, regulatory and safety-related requirements concerning its products, and any use of TI components in its applications, notwithstanding any applications-related information or support that may be provided by TI. Buyer represents and agrees that it has all the necessary expertise to create and implement safeguards which anticipate dangerous consequences of failures, monitor failures and their consequences, lessen the likelihood of failures that might cause harm and take appropriate remedial actions. Buyer will fully indemnify TI and its representatives against any damages arising out of the use of any TI components in safety-critical applications.

In some cases, TI components may be promoted specifically to facilitate safety-related applications. With such components, TI's goal is to help enable customers to design and create their own end-product solutions that meet applicable functional safety standards and requirements. Nonetheless, such components are subject to these terms.

No TI components are authorized for use in FDA Class III (or similar life-critical medical equipment) unless authorized officers of the parties have executed a special agreement specifically governing such use.

Only those TI components which TI has specifically designated as military grade or "enhanced plastic" are designed and intended for use in military/aerospace applications or environments. Buyer acknowledges and agrees that any military or aerospace use of TI components which have **not** been so designated is solely at the Buyer's risk, and that Buyer is solely responsible for compliance with all legal and regulatory requirements in connection with such use.

TI has specifically designated certain components as meeting ISO/TS16949 requirements, mainly for automotive use. In any case of use of non-designated products, TI will not be responsible for any failure to meet ISO/TS16949.

Products

Audio	www.ti.com/audio
Amplifiers	amplifier.ti.com
Data Converters	dataconverter.ti.com
DLP® Products	www.dlp.com
DSP	dsp.ti.com
Clocks and Timers	www.ti.com/clocks
Interface	interface.ti.com
Logic	logic.ti.com
Power Mgmt	power.ti.com
Microcontrollers	microcontroller.ti.com
RFID	www.ti-rfid.com
OMAP Applications Processors	www.ti.com/omap
Wireless Connectivity	www.ti.com/wirelessconnectivity

Applications

Automotive and Transportation	www.ti.com/automotive
Communications and Telecom	www.ti.com/communications
Computers and Peripherals	www.ti.com/computers
Consumer Electronics	www.ti.com/consumer-apps
Energy and Lighting	www.ti.com/energy
Industrial	www.ti.com/industrial
Medical	www.ti.com/medical
Security	www.ti.com/security
Space, Avionics and Defense	www.ti.com/space-avionics-defense
Video and Imaging	www.ti.com/video

TI E2E Community

e2e.ti.com