

- Output Swing Includes Both Supply Rails
- Low Noise . . . 12 nV/√Hz Typ at f = 1 kHz
- Low Input Bias Current . . . 1 pA Typ
- Fully Specified for Both Single-Supply and Split-Supply Operation
- Low Power . . . 500 μA Max
- Common-Mode Input Voltage Range Includes Negative Rail
- Low Input Offset Voltage
950 μV Max at T_A = 25°C (TLV226xA)
- Wide Supply Voltage Range
2.7 V to 8 V
- Macromodel Included
- Available in Q-Temp Automotive
HighRel Automotive Applications
Configuration Control / Print Support
Qualification to Automotive Standards

description

The TLV2262 and TLV2264 are dual and quad low voltage operational amplifiers from Texas Instruments. Both devices exhibit rail-to-rail output performance for increased dynamic range in single or split supply applications. The TLV226x family offers a compromise between the micro-power TLV225x and the ac performance of the TLC227x. It has low supply current for battery-powered applications, while still having adequate ac performance for applications that demand it. This family is fully characterized at 3 V and 5 V and is optimized for low-voltage applications. The noise performance has been dramatically improved over previous generations of CMOS amplifiers. Figure 1 depicts the low level of noise voltage for this CMOS amplifier, which has only 200 μA (typ) of supply current per amplifier.

The TLV226x, exhibiting high input impedance and low noise, are excellent for small-signal conditioning for high-impedance sources, such as piezoelectric transducers. Because of the micro-power dissipation levels combined with 3-V operation, these devices work well in hand-held monitoring and remote-sensing applications. In addition, the rail-to-rail output feature with single or split supplies makes this family a great choice when interfacing with analog-to-digital converters (ADCs). For precision applications, the TLV226xA family is available and has a maximum input offset voltage of 950 μV.

The TLV2262/4 also makes great upgrades to the TLV2332/4 in standard designs. They offer increased output dynamic range, lower noise voltage and lower input offset voltage. This enhanced feature set allows them to be used in a wider range of applications. For applications that require higher output drive and wider input voltage range, see the TLV2432 and TLV2442 devices. If your design requires single amplifiers, please see the TLV2211/21/31 family. These devices are single rail-to-rail operational amplifiers in the SOT-23 package. Their small size and low power consumption, make them ideal for high density, battery-powered equipment.

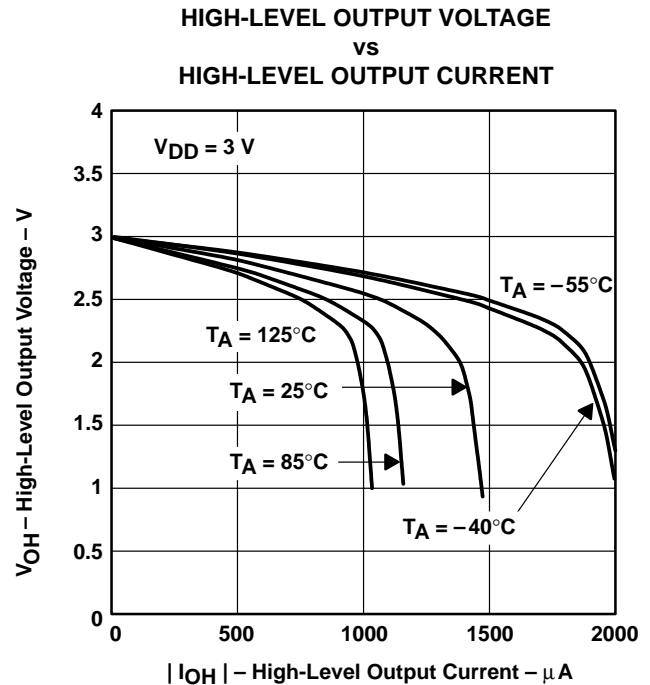

Figure 1



Please be aware that an important notice concerning availability, standard warranty, and use in critical applications of Texas Instruments semiconductor products and disclaimers thereto appears at the end of this data sheet.

Advanced LinCMOS is a trademark of Texas Instruments.

PRODUCTION DATA information is current as of publication date. Products conform to specifications per the terms of Texas Instruments standard warranty. Production processing does not necessarily include testing of all parameters.

 **TEXAS
INSTRUMENTS**

POST OFFICE BOX 655303 • DALLAS, TEXAS 75265

Copyright © 2001, Texas Instruments Incorporated
On products compliant to MIL-PRF-38535, all parameters are tested unless otherwise noted. On all other products, production processing does not necessarily include testing of all parameters.

TLV226x, TLV226xA Advanced LinCMOS™ RAIL-TO-RAIL OPERATIONAL AMPLIFIERS

SLOS186B – FEBRUARY 1997 – REVISED MARCH 2001

TLV2262 AVAILABLE OPTIONS

| T _A | V _{IO} max AT 25°C | PACKAGED DEVICES | | | | | |
|----------------|--------------------------------|-------------------------|---------------------------|---------------------------|-------------------------|--------------------|----------------------------|
| | | SMALL OUTLINE (D) | CHIP CARRIER (FK) | CERAMIC DIP (JG) | PLASTIC DIP (P) | TSSOP (PW) | CERAMIC FLATPACK (U) |
| 0°C to 70°C | 2.5 mV | TLV2262CD | — | — | TLV2262CP | TLV2262CPWLE | — |
| –40°C to 125°C | 950 μV 2.5 mV | TLV2262AID TLV2262ID | — — | — — | TLV2262AIP TLV2262IP | TLV2262AIPWLE — | — — |
| –40°C to 125°C | 950 μV 2.5 mV | TLV2262AQD TLV2262QD | — — | — — | — — | — — | — — |
| –55°C to 125°C | 950 μV 2.5 mV | — — | TLV2262AMFK TLV2262MFK | TLV2262AMJG TLV2262MJG | — — | — — | TLV2262AMU TLV2262MU |

† The D packages are available taped and reeled. Add R suffix to device type (e.g., TLV2262CDR).

‡ The PW package is available only left-end taped and reeled.

§ Chips are tested at 25°C.

TLV2264 AVAILABLE OPTIONS

| T _A | V _{IO} max AT 25°C | PACKAGED DEVICES | | | | | |
|-------------------|--------------------------------|-------------------------|---------------------------|-------------------------|-------------------------|--------------------|----------------------------|
| | | SMALL OUTLINE (D) | CHIP CARRIER (FK) | CERAMIC DIP (J) | PLASTIC DIP (N) | TSSOP (PW) | CERAMIC FLATPACK (W) |
| –40°C to 125°C | 950 μV 2.5 mV | TLV2264AID TLV2264ID | — — | — — | TLV2264AIN TLV2264IN | TLV2264AIPWLE — | — — |
| –40°C to 125°C | 950 μV 2.5 mV | TLV2264AQD TLV2264QD | — — | — — | — — | — — | — — |
| –55°C to 125°C | 950 μV 2.5 mV | — — | TLV2264AMFK TLV2264MFK | TLV2264AMJ TLV2264MJ | — — | — — | TLV2264AMW TLV2264MW |

† The D packages are available taped and reeled. Add R suffix to device type (e.g., TLV2262IDR).

‡ The PW package is available only left-end taped and reeled.

§ Chips are tested at 25°C.



TLV226x, TLV226xA
Advanced LinCMOS™ RAIL-TO-RAIL
OPERATIONAL AMPLIFIERS

SLOS186B – FEBRUARY 1997 – REVISED MARCH 2001

TLV2262C, TLV2262AC
TLV2262I, TLV2262AI
TLV2262Q, TLV2262AQ
D, P, OR PW PACKAGE
(TOP VIEW)

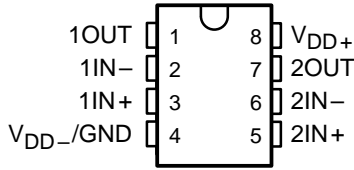

TLV2264I, TLV2264AI
TLV2264Q, TLV2264AQ
D, N, OR PW PACKAGE
(TOP VIEW)

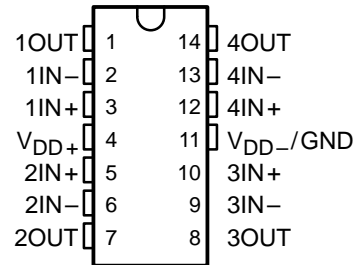

TLV2262M, TLV2262AM
JG PACKAGE
(TOP VIEW)

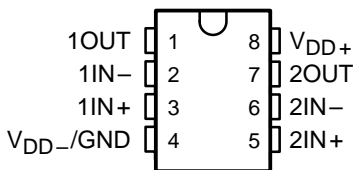

TLV2264M, TLV2264AM
J OR W PACKAGE
(TOP VIEW)

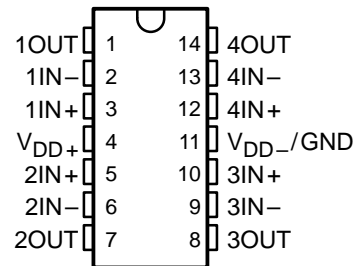

TLV2662M, TLV2262AM
U PACKAGE
(TOP VIEW)

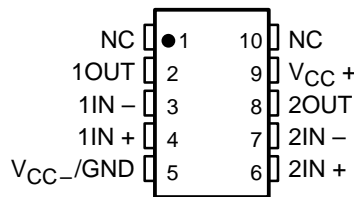

TLV2264M, TLV2264AM
FK PACKAGE
(TOP VIEW)

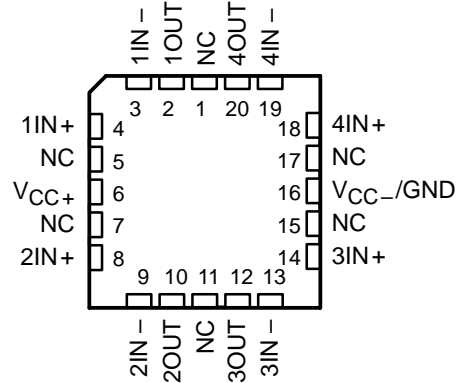

TLV2262M, TLV2262AM
FK PACKAGE
(TOP VIEW)

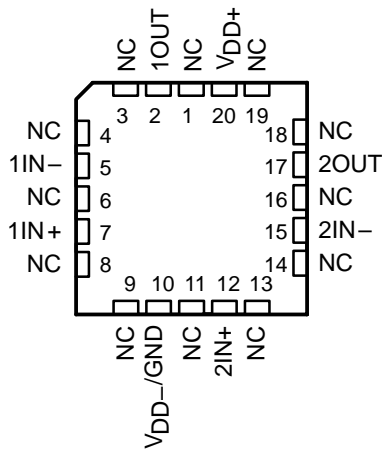

TLV226x, TLV226xA
Advanced LinCMOS™ RAIL-TO-RAIL
OPERATIONAL AMPLIFIERS

SLOS186B – FEBRUARY 1997 – REVISED MARCH 2001

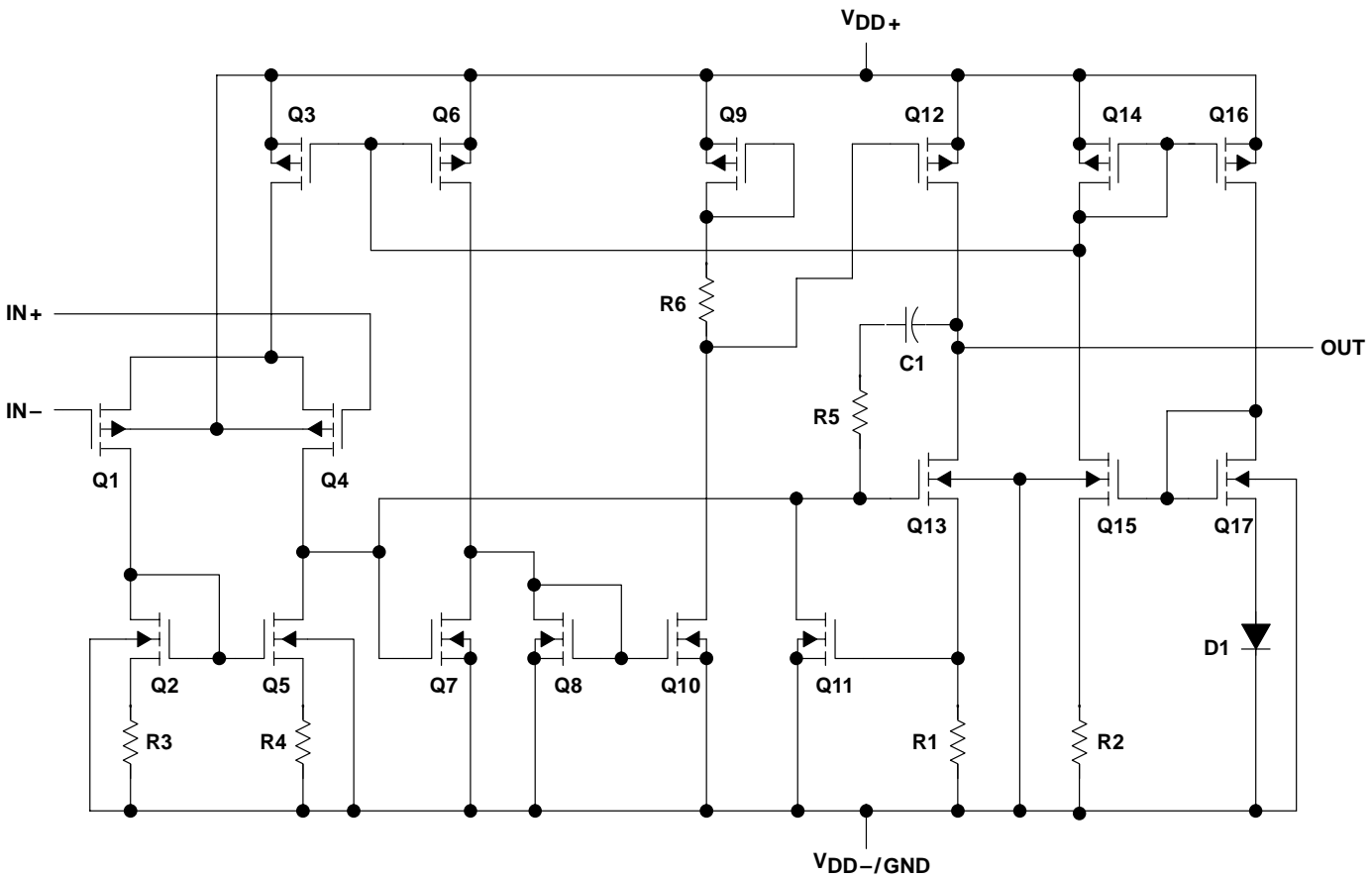

| ACTUAL DEVICE COMPONENT COUNT† | | |
|--------------------------------|---------|---------|
| COMPONENT | TLV2252 | TLV2254 |
| Transistors | 38 | 76 |
| Resistors | 28 | 54 |
| Diodes | 9 | 18 |
| Capacitors | 3 | 6 |

† Includes both amplifiers and all ESD, bias, and trim circuitry

equivalent schematic (each amplifier)

absolute maximum ratings over operating free-air temperature range (unless otherwise noted)†

| | |
|--|--------------------------------|
| Supply voltage, V_{DD} (see Note 1) | 16 V |
| Differential input voltage, V_{ID} (see Note 2) | $\pm V_{DD}$ |
| Input voltage range, V_I (any input, see Note 1) | $V_{DD-} - 0.3$ V to V_{DD+} |
| Input current, I_I (each input) | ± 5 mA |
| Output current, I_O | ± 50 mA |
| Total current into V_{DD+} | ± 50 mA |
| Total current out of V_{DD-} | ± 50 mA |
| Duration of short-circuit current (at or below) 25°C (see Note 3) | unlimited |
| Continuous total power dissipation | See Dissipation Rating Table |
| Operating free-air temperature range, T_A : | |
| I suffix | –40°C to 125°C |
| Q suffix | –40°C to 125°C |
| M suffix | –55°C to 125°C |
| Storage temperature range, T_{stg} | –65°C to 150°C |
| Lead temperature 1,6 mm (1/16 inch) from case for 10 seconds: D, N, P, and PW packages | 260°C |
| FK, J, JG, U, AND W packages | 300°C |

† Stresses beyond those listed under “absolute maximum ratings” may cause permanent damage to the device. These are stress ratings only, and functional operation of the device at these or any other conditions beyond those indicated under “recommended operating conditions” is not implied. Exposure to absolute-maximum-rated conditions for extended periods may affect device reliability.

- NOTES:
1. All voltage values, except differential voltages, are with respect to V_{DD-} .
 2. Differential voltages are at the noninverting input with respect to the inverting input. Excessive current flows when input is brought below $V_{DD-} - 0.3$ V.
 3. The output may be shorted to either supply. Temperature and/or supply voltages must be limited to ensure that the maximum dissipation rating is not exceeded.

DISSIPATION RATING TABLE

| PACKAGE | $T_A \leq 25^\circ\text{C}$ POWER RATING | DERATING FACTOR ABOVE $T_A = 25^\circ\text{C}$ | $T_A = 85^\circ\text{C}$ POWER RATING | $T_A = 125^\circ\text{C}$ POWER RATING |
|---------|---|---|--|---|
| D–8 | 725 mW | 5.8 mW/°C | 377 mW | 145 mW |
| D–14 | 950 mW | 7.6 mW/°C | 494 mW | 190 mW |
| FK | 1375 mW | 11.0 mW/°C | 715 mW | 275 mW |
| J | 1375 mW | 11.0 mW/°C | 715 mW | 275 mW |
| JG | 1050 mW | 8.4 mW/°C | — | 210 mW |
| N | 1150 mW | 9.2 mW/°C | 598 mW | — |
| P | 1000 mW | 8.0 mW/°C | 520 mW | 200 mW |
| PW–8 | 525 mW | 4.2 mW/°C | 273 mW | 105 mW |
| PW–14 | 700 mW | 5.6 mW/°C | 364 mW | — |
| U | 700 mW | 5.5 mW/°C | — | 150 mW |
| W | 700 mW | 5.5 mW/°C | 370 mW | 150 mW |

recommended operating conditions

| | I SUFFIX | | Q SUFFIX | | M SUFFIX | | UNIT |
|--|-----------|-----------------|-----------|-----------------|-----------|-----------------|------|
| | MIN | MAX | MIN | MAX | MIN | MAX | |
| Supply voltage, $V_{DD\pm}$ (see Note 1) | 2.7 | 16 | 2.7 | 16 | 2.7 | 16 | V |
| Input voltage range, V_I | V_{DD-} | $V_{DD+} - 1.3$ | V_{DD-} | $V_{DD+} - 1.3$ | V_{DD-} | $V_{DD+} - 1.3$ | V |
| Common-mode input voltage, V_{IC} | V_{DD-} | $V_{DD+} - 1.3$ | V_{DD-} | $V_{DD+} - 1.3$ | V_{DD-} | $V_{DD+} - 1.3$ | V |
| Operating free-air temperature, T_A | –40 | 125 | –40 | 125 | –55 | 125 | °C |

NOTE 1: All voltage values, except differential voltages, are with respect to V_{DD-} .

TLV226x, TLV226xA Advanced LinCMOS™ RAIL-TO-RAIL OPERATIONAL AMPLIFIERS

SLOS186B – FEBRUARY 1997 – REVISED MARCH 2001

TLV2262I electrical characteristics at specified free-air temperature, $V_{DD} = 3\text{ V}$ (unless otherwise noted)

| PARAMETER | TEST CONDITIONS | T_A † | TLV2262I | | | TLV2262AI | | | UNIT |
|--|---|------------------------------|------------|-------------|-------|-----------|-------------|----------|------------------------------|
| | | | MIN | TYP | MAX | MIN | TYP | MAX | |
| V_{IO} Input offset voltage | $V_{DD\pm} = \pm 1.5\text{ V}$, $V_{IC} = 0$, $V_O = 0$, $R_S = 50\ \Omega$ | 25°C | | 300 | 2500 | | 300 | 950 | μV |
| | | Full range | | | 3000 | | | 1500 | |
| αV_{IO} Temperature coefficient of input offset voltage | | 25°C to 85°C | | 2 | | | 2 | | $\mu\text{V}/^\circ\text{C}$ |
| Input offset voltage long-term drift (see Note 4) | | 25°C | | 0.003 | | | 0.003 | | $\mu\text{V}/\text{mo}$ |
| I_{IO} Input offset current | | 25°C | | 0.5 | 60 | | 0.5 | 60 | pA |
| | | 85°C | | | 150 | | | 150 | |
| | | Full range | | | 800 | | | 800 | |
| I_{IB} Input bias current | | 25°C | | 1 | 60 | | 1 | 60 | pA |
| | | 85°C | | | 150 | | | 150 | |
| | | Full range | | | 800 | | | 800 | |
| V_{ICR} Common-mode input voltage range | $R_S = 50\ \Omega$, $ V_{IO} \leq 5\text{ mV}$ | 25°C | 0 to 2 | -0.3 to 2.2 | | 0 to 2 | -0.3 to 2.2 | V | |
| | | Full range | 0 to 1.7 | | | 0 to 1.7 | | | |
| V_{OH} High-level output voltage | $I_{OH} = -20\ \mu\text{A}$ | 25°C | | 2.99 | | | 2.99 | V | |
| | $I_{OH} = -100\ \mu\text{A}$ | 25°C | | 2.85 | | | 2.85 | | |
| | $I_{OH} = -400\ \mu\text{A}$ | Full range | | | 2.825 | | | | 2.825 |
| | | 25°C | | | 2.7 | | | | 2.7 |
| V_{OL} Low-level output voltage | $V_{IC} = 1.5\text{ V}$, $I_{OL} = 50\ \mu\text{A}$ | 25°C | | 10 | | | 10 | mV | |
| | | 25°C | | 100 | | | 100 | | |
| | $V_{IC} = 1.5\text{ V}$, $I_{OL} = 500\ \mu\text{A}$ | Full range | | | 150 | | | | 150 |
| | | 25°C | | | 200 | | | | 200 |
| | | Full range | | | 300 | | | | 300 |
| A_{VD} Large-signal differential voltage amplification | $V_{IC} = 1.5\text{ V}$, $V_O = 1\text{ V to } 2\text{ V}$ | $R_L = 50\ \text{k}\Omega$ ‡ | 25°C | 60 | 100 | | 60 | 100 | V/mV |
| | | | Full range | | 30 | | | 30 | |
| | | $R_L = 1\ \text{M}\Omega$ ‡ | 25°C | | 100 | | | 100 | |
| $r_{i(d)}$ Differential input resistance | | 25°C | | 10^{12} | | | 10^{12} | Ω | |
| $r_{i(c)}$ Common-mode input resistance | | 25°C | | 10^{12} | | | 10^{12} | Ω | |
| $c_{i(c)}$ Common-mode input capacitance | $f = 10\ \text{kHz}$, P package | 25°C | | 8 | | | 8 | pF | |
| z_o Closed-loop output impedance | $f = 100\ \text{kHz}$, $A_V = 10$ | 25°C | | 270 | | | 270 | Ω | |
| CMRR Common-mode rejection ratio | $V_{IC} = 0\text{ to } 1.7\text{ V}$, $V_O = 1.5\text{ V}$, $R_S = 50\ \Omega$ | 25°C | 65 | 75 | | 65 | 77 | dB | |
| | | Full range | | 60 | | | 60 | | |
| k_{SVR} Supply voltage rejection ratio ($\Delta V_{DD}/\Delta V_{IO}$) | $V_{DD} = 2.7\text{ V to } 8\text{ V}$, $V_{IC} = V_{DD}/2$, No load | 25°C | 80 | 95 | | 80 | 100 | dB | |
| | | Full range | | 80 | | | 80 | | |

† Full range is -40°C to 125°C .

‡ Referenced to 1.5 V

NOTE 4: Typical values are based on the input offset voltage shift observed through 500 hours of operating life test at $T_A = 150^\circ\text{C}$ extrapolated to $T_A = 25^\circ\text{C}$ using the Arrhenius equation and assuming an activation energy of 0.96 eV.



TLV2262I electrical characteristics at specified free-air temperature, $V_{DD} = 3\text{ V}$ (unless otherwise noted) (continued)

| PARAMETER | TEST CONDITIONS | T_A † | TLV2262I | | | TLV2262AI | | | UNIT |
|-------------------------|--------------------------------|------------|----------|-----|-----|-----------|-----|---------------|------|
| | | | MIN | TYP | MAX | MIN | TYP | MAX | |
| I_{DD} Supply current | $V_O = 1.5\text{ V}$, No load | 25°C | 400 | 500 | | 400 | 500 | μA | |
| | | Full range | | 500 | | | 500 | | |

† Full range is –40°C to 125°C.

TLV2262I operating characteristics at specified free-air temperature, $V_{DD} = 3\text{ V}$

| PARAMETER | TEST CONDITIONS | T_A † | TLV2262I | | | TLV2262AI | | | UNIT |
|---|---|------------|----------|------|-----|-----------|------|------------------------|------------------------------|
| | | | MIN | TYP | MAX | MIN | TYP | MAX | |
| SR Slew rate at unity gain | $V_O = 1.1\text{ V to }1.9\text{ V}$, $R_L = 50\text{ k}\Omega$ ‡, $C_L = 100\text{ pF}$ ‡ | 25°C | 0.35 | 0.55 | | 0.35 | 0.55 | $\text{V}/\mu\text{s}$ | |
| | | Full range | 0.3 | | | 0.3 | | | |
| V_n Equivalent input noise voltage | $f = 10\text{ Hz}$ | 25°C | 43 | | | 43 | | | $\text{nV}/\sqrt{\text{Hz}}$ |
| | $f = 1\text{ kHz}$ | 25°C | 12 | | | 12 | | | |
| $V_{N(PP)}$ Peak-to-peak equivalent input noise voltage | $f = 0.1\text{ Hz to }1\text{ Hz}$ | 25°C | 0.6 | | | 0.6 | | | μV |
| | $f = 0.1\text{ Hz to }10\text{ Hz}$ | 25°C | 1 | | | 1 | | | |
| I_n Equivalent input noise current | | 25°C | 0.6 | | | 0.6 | | | $\text{fA}/\sqrt{\text{Hz}}$ |
| THD + N Total harmonic distortion plus noise | $V_O = 0.5\text{ V to }2.5\text{ V}$, $f = 20\text{ kHz}$, $R_L = 50\text{ k}\Omega$ ‡ | $A_V = 1$ | 0.03% | | | 0.03% | | | |
| | | $A_V = 10$ | 0.05% | | | 0.05% | | | |
| Gain-bandwidth product | $f = 1\text{ kHz}$, $C_L = 100\text{ pF}$ ‡, $R_L = 50\text{ k}\Omega$ ‡ | 25°C | 0.67 | | | 0.67 | | | MHz |
| B_{OM} Maximum output-swing bandwidth | $V_{O(PP)} = 1\text{ V}$, $R_L = 50\text{ k}\Omega$ ‡, $A_V = 1$, $C_L = 100\text{ pF}$ ‡ | 25°C | 395 | | | 395 | | | kHz |
| t_s Settling time | $A_V = -1$, Step = 1 V to 2 V, $R_L = 50\text{ k}\Omega$ ‡, $C_L = 100\text{ pF}$ ‡ | To 0.1% | 5.6 | | | 5.6 | | | μs |
| | | To 0.01% | 12.5 | | | 12.5 | | | |
| ϕ_m Phase margin at unity gain | $R_L = 50\text{ k}\Omega$ ‡, $C_L = 100\text{ pF}$ ‡ | 25°C | 55° | | | 55° | | | |
| Gain margin | | 25°C | 11 | | | 11 | | | dB |

† Full range is –40°C to 125°C.

‡ Referenced to 1.5 V

TLV226x, TLV226xA Advanced LinCMOS™ RAIL-TO-RAIL OPERATIONAL AMPLIFIERS

SLOS186B – FEBRUARY 1997 – REVISED MARCH 2001

TLV2262I electrical characteristics at specified free-air temperature, $V_{DD} = 5\text{ V}$ (unless otherwise noted)

| PARAMETER | TEST CONDITIONS | T_A † | TLV2262I | | | TLV2262AI | | | UNIT |
|--|--|-----------------------------|------------|-------------|----------|-----------|-------------|---------------|------------------------------|
| | | | MIN | TYP | MAX | MIN | TYP | MAX | |
| V_{IO} Input offset voltage | | 25°C | 300 | 2500 | | 300 | 950 | μV | |
| | | Full range | | | 3000 | | 1500 | | |
| α_{VIO} Temperature coefficient of input offset voltage | | 25°C to 85°C | 2 | | | 2 | | | $\mu\text{V}/^\circ\text{C}$ |
| Input offset voltage long-term drift (see Note 4) | $V_{DD} = \pm 2.5\text{ V}$, $V_{IC} = 0$, $V_O = 0$, $R_S = 50\ \Omega$ | 25°C | 0.003 | | | 0.003 | | | $\mu\text{V}/\text{mo}$ |
| I_{IO} Input offset current | | 25°C | 0.5 | 60 | | 0.5 | 60 | pA | |
| | | 85°C | 150 | | | 150 | | | |
| | | Full range | 800 | | | 800 | | | |
| I_{IB} Input bias current | | 25°C | 1 | 60 | | 1 | 60 | pA | |
| | | 85°C | 150 | | | 150 | | | |
| | Full range | 800 | | | 800 | | | | |
| V_{ICR} Common-mode input voltage range | $ V_{IO} \leq 5\text{ mV}$, $R_S = 50\ \Omega$ | 25°C | 0 to 4 | -0.3 to 4.2 | | 0 to 4 | -0.3 to 4.2 | V | |
| | | Full range | 0 to 3.5 | | 0 to 3.5 | | | | |
| V_{OH} High-level output voltage | $I_{OH} = -20\ \mu\text{A}$ | 25°C | 4.99 | | | 4.99 | | | V |
| | | 25°C | 4.85 | 4.94 | | 4.85 | 4.94 | | |
| | $I_{OH} = -100\ \mu\text{A}$ | Full range | 4.82 | | | 4.82 | | | |
| | | 25°C | 4.7 | 4.85 | | 4.7 | 4.85 | | |
| V_{OL} Low-level output voltage | $V_{IC} = 2.5\text{ V}$, $I_{OL} = 50\ \mu\text{A}$ | 25°C | 0.01 | | | 0.01 | | | V |
| | | 25°C | 0.09 | 0.15 | | 0.09 | 0.15 | | |
| | $V_{IC} = 2.5\text{ V}$, $I_{OL} = 500\ \mu\text{A}$ | Full range | 0.15 | | | 0.15 | | | |
| | | 25°C | 0.2 | 0.3 | | 0.2 | 0.3 | | |
| V_{OL} Low-level output voltage | $V_{IC} = 2.5\text{ V}$, $I_{OL} = 1\text{ mA}$ | 25°C | 0.2 | | | 0.2 | | | |
| | | Full range | 0.3 | | | 0.3 | | | |
| | $V_{IC} = 2.5\text{ V}$, $V_O = 1\text{ V to }4\text{ V}$ | $R_L = 50\text{ k}\Omega$ ‡ | 25°C | 80 | 170 | | 80 | 170 | V/mV |
| | | | Full range | 55 | | | 55 | | |
| $R_L = 1\text{ M}\Omega$ ‡ | | 25°C | 550 | | | 550 | | | |
| $r_{i(d)}$ Differential input resistance | | 25°C | 10^{12} | | | 10^{12} | | | Ω |
| $r_{i(c)}$ Common-mode input resistance | | 25°C | 10^{12} | | | 10^{12} | | | Ω |
| $C_{i(c)}$ Common-mode input capacitance | $f = 10\text{ kHz}$, P package | 25°C | 8 | | | 8 | | | pF |
| z_o Closed-loop output impedance | $f = 100\text{ kHz}$, $A_V = 10$ | 25°C | 240 | | | 240 | | | Ω |
| CMRR Common-mode rejection ratio | $V_{IC} = 0\text{ to }2.7\text{ V}$, $V_O = 2.5\text{ V}$, $R_S = 50\ \Omega$ | 25°C | 70 | 83 | | 70 | 83 | dB | |
| | | Full range | 70 | | | 70 | | | |
| k_{SVR} Supply voltage rejection ratio ($\Delta V_{DD}/\Delta V_{IO}$) | $V_{DD} = 4.4\text{ V to }8\text{ V}$, $V_{IC} = V_{DD}/2$, No load | 25°C | 80 | 95 | | 80 | 95 | dB | |
| | | Full range | 80 | | | 80 | | | |

† Full range is -40°C to 125°C .

‡ Referenced to 2.5 V

NOTE 4: Typical values are based on the input offset voltage shift observed through 500 hours of operating life test at $T_A = 150^\circ\text{C}$ extrapolated to $T_A = 25^\circ\text{C}$ using the Arrhenius equation and assuming an activation energy of 0.96 eV.



TLV2262I electrical characteristics at specified free-air temperature, $V_{DD} = 5\text{ V}$ (unless otherwise noted) (continued)

| PARAMETER | TEST CONDITIONS | T_A † | TLV2262I | | | TLV2262AI | | | UNIT |
|-------------------------|--------------------------------|------------|----------|-----|-----|-----------|-----|---------------|------|
| | | | MIN | TYP | MAX | MIN | TYP | MAX | |
| I_{DD} Supply current | $V_O = 2.5\text{ V}$, No load | 25°C | 400 | 500 | | 400 | 500 | μA | |
| | | Full range | | 500 | | | 500 | | |

† Full range is -40°C to 125°C .

TLV2262I operating characteristics at specified free-air temperature, $V_{DD} = 5\text{ V}$

| PARAMETER | TEST CONDITIONS | T_A † | TLV2262I | | | TLV2262AI | | | UNIT |
|---|---|-------------|----------|------|-----|-----------|------|------------------------|------------------------------|
| | | | MIN | TYP | MAX | MIN | TYP | MAX | |
| SR Slew rate at unity gain | $V_O = 1.5\text{ V to }3.5\text{ V}$, $R_L = 50\text{ k}\Omega$ ‡, $C_L = 100\text{ pF}$ ‡ | 25°C | 0.35 | 0.55 | | 0.35 | 0.55 | $\text{V}/\mu\text{s}$ | |
| | | Full range | 0.3 | | | 0.3 | | | |
| V_n Equivalent input noise voltage | $f = 10\text{ Hz}$ | 25°C | 40 | | | 40 | | | $\text{nV}/\sqrt{\text{Hz}}$ |
| | $f = 1\text{ kHz}$ | 25°C | 12 | | | 12 | | | |
| $V_{N(PP)}$ Peak-to-peak equivalent input noise voltage | $f = 0.1\text{ Hz to }1\text{ Hz}$ | 25°C | 0.7 | | | 0.7 | | | μV |
| | $f = 0.1\text{ Hz to }10\text{ Hz}$ | 25°C | 1.3 | | | 1.3 | | | |
| I_n Equivalent input noise current | | 25°C | 0.6 | | | 0.6 | | | $\text{fA}/\sqrt{\text{Hz}}$ |
| THD + N Total harmonic distortion plus noise | $V_O = 0.5\text{ V to }2.5\text{ V}$, $f = 20\text{ kHz}$, $R_L = 50\text{ k}\Omega$ ‡ | $A_V = 1$ | 0.017% | | | 0.017% | | | |
| | | $A_V = 10$ | 0.03% | | | 0.03% | | | |
| Gain-bandwidth product | $f = 50\text{ kHz}$, $C_L = 100\text{ pF}$ ‡, $R_L = 50\text{ k}\Omega$ ‡ | 25°C | 0.71 | | | 0.71 | | | MHz |
| BOM Maximum output-swing bandwidth | $V_{O(PP)} = 2\text{ V}$, $R_L = 50\text{ k}\Omega$ ‡, $A_V = 1$, $C_L = 100\text{ pF}$ ‡ | 25°C | 185 | | | 185 | | | kHz |
| t_s Settling time | $A_V = -1$, Step = $0.5\text{ V to }2.5\text{ V}$, $R_L = 50\text{ k}\Omega$ ‡, $C_L = 100\text{ pF}$ ‡ | To 0.1% | 6.4 | | | 6.4 | | | μs |
| | | To 0.01% | 14.1 | | | 14.1 | | | |
| ϕ_m Phase margin at unity gain | $R_L = 50\text{ k}\Omega$ ‡, $C_L = 100\text{ pF}$ ‡ | 25°C | 56° | | | 56° | | | |
| | | Gain margin | 25°C | 11 | | | 11 | | |

† Full range is -40°C to 125°C .

‡ Referenced to 2.5 V

TLV226x, TLV226xA Advanced LinCMOS™ RAIL-TO-RAIL OPERATIONAL AMPLIFIERS

SLOS186B – FEBRUARY 1997 – REVISED MARCH 2001

TLV2264I electrical characteristics at specified free-air temperature, $V_{DD} = 3\text{ V}$ (unless otherwise noted)

| PARAMETER | TEST CONDITIONS | T_A † | TLV2264I | | | TLV2264AI | | | UNIT |
|--|---|--|------------|-------------|----------|-----------|-------------|------------------------------|------|
| | | | MIN | TYP | MAX | MIN | TYP | MAX | |
| V_{IO} Input offset voltage | | 25°C | 300 | 2500 | | 300 | 950 | μV | |
| | | Full range | | 3000 | | 1500 | | | |
| α_{VIO} Temperature coefficient of input offset voltage | | 25°C to 85°C | 2 | | | 2 | | $\mu\text{V}/^\circ\text{C}$ | |
| Input offset voltage long-term drift (see Note 4) | $V_{DD\pm} = \pm 1.5\text{ V}$, $V_{IC} = 0$, $V_O = 0$, $R_S = 50\ \Omega$ | 25°C | 0.003 | | | 0.003 | | $\mu\text{V}/\text{mo}$ | |
| I_{IO} Input offset current | | 25°C | 0.5 | 60 | | 0.5 | 60 | pA | |
| | | 85°C | | 150 | | 150 | | | |
| | | Full range | | 800 | | 800 | | | |
| I_{IB} Input bias current | | 25°C | 1 | 60 | | 1 | 60 | pA | |
| | | 85°C | | 150 | | 150 | | | |
| | Full range | | 800 | | 800 | | | | |
| V_{ICR} Common-mode input voltage range | $R_S = 50\ \Omega$, $ V_{IO} \leq 5\text{ mV}$ | 25°C | 0 to 2 | -0.3 to 2.2 | | 0 to 2 | -0.3 to 2.2 | V | |
| | | Full range | 0 to 1.7 | | 0 to 1.7 | | | | |
| V_{OH} High-level output voltage | $I_{OH} = -20\ \mu\text{A}$ | 25°C | 2.99 | | 2.99 | | V | | |
| | $I_{OH} = -100\ \mu\text{A}$ | 25°C | 2.85 | | 2.85 | | | | |
| | | Full range | 2.825 | | 2.825 | | | | |
| | $I_{OH} = -400\ \mu\text{A}$ | 25°C | 2.7 | | 2.7 | | | | |
| Full range | | 2.65 | | 2.65 | | | | | |
| V_{OL} Low-level output voltage | $V_{IC} = 1.5\text{ V}$, $I_{OL} = 50\ \mu\text{A}$ | 25°C | 10 | | 10 | | mV | | |
| | | 25°C | 100 | | 100 | | | | |
| | $V_{IC} = 1.5\text{ V}$, $I_{OL} = 500\ \mu\text{A}$ | Full range | 150 | | 150 | | | | |
| | | $V_{IC} = 1.5\text{ V}$, $I_{OL} = 1\text{ mA}$ | 25°C | 200 | | 200 | | | |
| Full range | 300 | | 300 | | | | | | |
| A_{VD} Large-signal differential voltage amplification | $V_{IC} = 1.5\text{ V}$, $V_O = 1\text{ to }2\text{ V}$ | $R_L = 50\text{ k}\Omega$ ‡ | 25°C | 60 | 100 | 60 | 100 | V/mV | |
| | | | Full range | 30 | | 30 | | | |
| | | $R_L = 1\text{ M}\Omega$ ‡ | 25°C | 100 | | 100 | | | |
| $r_{i(d)}$ Differential input resistance | | 25°C | 1012 | | 1012 | | Ω | | |
| $r_{i(c)}$ Common-mode input resistance | | 25°C | 1012 | | 1012 | | Ω | | |
| $C_{i(c)}$ Common-mode input capacitance | $f = 10\text{ kHz}$, N package | 25°C | 8 | | 8 | | pF | | |
| z_o Closed-loop output impedance | $f = 100\text{ kHz}$, $A_V = 10$ | 25°C | 270 | | 270 | | Ω | | |
| CMRR Common-mode rejection ratio | $V_{IC} = 0\text{ to }1.7\text{ V}$, $V_O = 1.5\text{ V}$, $R_S = 50\ \Omega$ | 25°C | 65 | 75 | 65 | 77 | dB | | |
| | | Full range | 60 | | 60 | | | | |
| k_{SVR} Supply voltage rejection ratio ($\Delta V_{DD}/\Delta V_{IO}$) | $V_{DD} = 2.7\text{ V to }8\text{ V}$, $V_{IC} = V_{DD}/2$, No load | 25°C | 80 | 95 | 80 | 100 | dB | | |
| | | Full range | 80 | | 80 | | | | |

† Full range is -40°C to 125°C .

‡ Referenced to 1.5 V

NOTE 4: Typical values are based on the input offset voltage shift observed through 500 hours of operating life test at $T_A = 150^\circ\text{C}$ extrapolated to $T_A = 25^\circ\text{C}$ using the Arrhenius equation and assuming an activation energy of 0.96 eV.



TLV2264I electrical characteristics at specified free-air temperature, $V_{DD} = 3\text{ V}$ (unless otherwise noted) (continued)

| PARAMETER | TEST CONDITIONS | T_A † | TLV2264I | | | TLV2264AI | | | UNIT |
|-----------|-------------------------------------|--------------------------------|------------|-----|-----|-----------|-----|-----|------|
| | | | MIN | TYP | MAX | MIN | TYP | MAX | |
| I_{DD} | Supply current (four amplifiers) | $V_O = 1.5\text{ V}$, No load | 25°C | 0.8 | 1 | 0.8 | 1 | mA | |
| | | | Full range | | 1 | | 1 | | |

† Full range is – 40°C to 125°C.

TLV2264I operating characteristics at specified free-air temperature, $V_{DD} = 3\text{ V}$

| PARAMETER | TEST CONDITIONS | T_A † | TLV2264I | | | TLV2264AI | | | UNIT |
|-------------|--|--|----------|------|-------|-----------|------------------------------|---------------|------|
| | | | MIN | TYP | MAX | MIN | TYP | MAX | |
| SR | Slew rate at unity gain $V_O = 0.7\text{ V}$ to 1.7 V , $R_L = 50\text{ k}\Omega$ ‡, $C_L = 100\text{ pF}$ ‡ | 25°C | 0.35 | 0.55 | 0.35 | 0.55 | $\text{V}/\mu\text{s}$ | | |
| | | Full range | 0.3 | | 0.3 | | | | |
| V_n | Equivalent input noise voltage $f = 10\text{ Hz}$ $f = 1\text{ kHz}$ | 25°C | | 43 | | 43 | $\text{nV}/\sqrt{\text{Hz}}$ | | |
| | | 25°C | | 12 | | 12 | | | |
| $V_{N(PP)}$ | Peak-to-peak equivalent input noise voltage $f = 0.1\text{ Hz}$ to 1 Hz $f = 0.1\text{ Hz}$ to 10 Hz | 25°C | | 0.6 | | 0.6 | μV | | |
| | | 25°C | | 1 | | 1 | | | |
| I_n | Equivalent input noise current | 25°C | | 0.6 | | 0.6 | $\text{fA}/\sqrt{\text{Hz}}$ | | |
| THD + N | Total harmonic distortion plus noise $V_O = 0.5\text{ V}$ to 2.5 V , $f = 20\text{ kHz}$, $R_L = 50\text{ k}\Omega$ ‡ | $A_V = 1$ | 25°C | | 0.03% | | 0.03% | | |
| | | $A_V = 10$ | 25°C | | 0.05% | | 0.05% | | |
| | Gain-bandwidth product $f = 1\text{ kHz}$, $C_L = 100\text{ pF}$ ‡ | $R_L = 50\text{ k}\Omega$ ‡ | 25°C | | 0.67 | | 0.67 | MHz | |
| BOM | Maximum output-swing bandwidth $V_{O(PP)} = 1\text{ V}$, $R_L = 50\text{ k}\Omega$ ‡ | $A_V = 1$, $C_L = 100\text{ pF}$ ‡ | 25°C | | 395 | | 395 | kHz | |
| t_s | Settling time $A_V = -1$, Step = 1 V to 2 V , $R_L = 50\text{ k}\Omega$ ‡, $C_L = 100\text{ pF}$ ‡ | To 0.1% | 25°C | | 5.6 | | 5.6 | μs | |
| | | To 0.01% | | | 12.5 | | 12.5 | | |
| ϕ_m | Phase margin at unity gain Gain margin | $R_L = 50\text{ k}\Omega$ ‡, $C_L = 100\text{ pF}$ ‡ | 25°C | | 55° | | 55° | dB | |
| | | | 25°C | | 11 | | 11 | | |

† Full range is – 40°C to 125°C.

‡ Referenced to 1.5 V

TLV226x, TLV226xA Advanced LinCMOS™ RAIL-TO-RAIL OPERATIONAL AMPLIFIERS

SLOS186B – FEBRUARY 1997 – REVISED MARCH 2001

TLV2264I electrical characteristics at specified free-air temperature, $V_{DD} = 5\text{ V}$ (unless otherwise noted)

| PARAMETER | TEST CONDITIONS | T_A † | TLV2264I | | | TLV2264AI | | | UNIT |
|--|---|------------------------------------|------------------|-------------|----------|------------------|-------------|---------------|------------------------------|
| | | | MIN | TYP | MAX | MIN | TYP | MAX | |
| V_{IO} Input offset voltage | | 25°C | 300 | 2500 | | 300 | 950 | μV | |
| | | Full range | | | 3000 | | 1500 | | |
| αV_{IO} Temperature coefficient of input offset voltage | | 25°C to 85°C | 2 | | | 2 | | | $\mu\text{V}/^\circ\text{C}$ |
| Input offset voltage long-term drift (see Note 4) | $V_{DD\pm} = \pm 2.5\text{ V}$, $V_{IC} = 0$, $V_O = 0$, $R_S = 50\ \Omega$ | 25°C | 0.003 | | | 0.003 | | | $\mu\text{V}/\text{mo}$ |
| I_{IO} Input offset current | | 25°C | 0.5 | 60 | | 0.5 | 60 | pA | |
| | | 85°C | | 150 | | 150 | | | |
| | | Full range | | 800 | | 800 | | | |
| I_{IB} Input bias current | | 25°C | 1 | 60 | | 1 | 60 | pA | |
| | | 85°C | | 150 | | 150 | | | |
| | Full range | | 800 | | 800 | | | | |
| V_{ICR} Common-mode input voltage range | $ V_{IO} \leq 5\text{ mV}$, $R_S = 50\ \Omega$ | 25°C | 0 to 4 | -0.3 to 4.2 | | 0 to 4 | -0.3 to 4.2 | V | |
| | | Full range | 0 to 3.5 | | 0 to 3.5 | | | | |
| V_{OH} High-level output voltage | $I_{OH} = -20\ \mu\text{A}$ | 25°C | 4.99 | | | 4.99 | | | V |
| | | 25°C | 4.85 | 4.94 | | 4.85 | 4.94 | | |
| | $I_{OH} = -100\ \mu\text{A}$ | Full range | 4.82 | | | 4.82 | | | |
| | | 25°C | 4.7 | 4.85 | | 4.7 | 4.85 | | |
| $I_{OH} = -400\ \mu\text{A}$ | Full range | 4.6 | | | 4.6 | | | | |
| | | | | | | | | | |
| V_{OL} Low-level output voltage | $V_{IC} = 2.5\text{ V}$, $I_{OL} = 50\ \mu\text{A}$ | 25°C | 0.01 | | | 0.01 | | | V |
| | | 25°C | 0.09 | 0.15 | | 0.09 | 0.15 | | |
| | $V_{IC} = 2.5\text{ V}$, $I_{OL} = 500\ \mu\text{A}$ | Full range | 0.15 | | | 0.15 | | | |
| | | 25°C | 0.2 | 0.3 | | 0.2 | 0.3 | | |
| $V_{IC} = 2.5\text{ V}$, $I_{OL} = 1\text{ mA}$ | Full range | 0.3 | | | 0.3 | | | | |
| | | | | | | | | | |
| A_{VD} Large-signal differential voltage amplification | $V_{IC} = 2.5\text{ V}$, $V_O = 1\text{ V to }4\text{ V}$ | $R_L = 50\text{ k}\Omega^\ddagger$ | 25°C | 80 | 170 | | 80 | 170 | V/mV |
| | | | Full range | 55 | | | 55 | | |
| | | $R_L = 1\text{ M}\Omega^\ddagger$ | 25°C | 550 | | | 550 | | |
| $r_{i(d)}$ Differential input resistance | | 25°C | 10 ¹² | | | 10 ¹² | | | Ω |
| $r_{i(c)}$ Common-mode input resistance | | 25°C | 10 ¹² | | | 10 ¹² | | | Ω |
| $C_{i(c)}$ Common-mode input capacitance | f = 10 kHz, N package | 25°C | 8 | | | 8 | | | pF |
| z_o Closed-loop output impedance | f = 100 kHz, $A_V = 10$ | 25°C | 240 | | | 240 | | | Ω |
| CMRR Common-mode rejection ratio | $V_{IC} = 0\text{ to }2.7\text{ V}$, $V_O = 2.5\text{ V}$, $R_S = 50\ \Omega$ | 25°C | 70 | 83 | | 70 | 83 | dB | |
| | | Full range | 70 | | | 70 | | | |
| k_{SVR} Supply voltage rejection ratio ($\Delta V_{DD}/\Delta V_{IO}$) | $V_{DD} = 4.4\text{ V to }8\text{ V}$, $V_{IC} = V_{DD}/2$, No load | 25°C | 80 | 95 | | 80 | 95 | dB | |
| | | Full range | 80 | | | 80 | | | |

† Full range is -40°C to 125°C.

‡ Referenced to 2.5 V

NOTE 4: Typical values are based on the input offset voltage shift observed through 500 hours of operating life test at $T_A = 150^\circ\text{C}$ extrapolated to $T_A = 25^\circ\text{C}$ using the Arrhenius equation and assuming an activation energy of 0.96 eV.



TLV2264I electrical characteristics at specified free-air temperature, $V_{DD} = 5\text{ V}$ (unless otherwise noted) (continued)

| PARAMETER | TEST CONDITIONS | T_A † | TLV2264I | | | TLV2264AI | | | UNIT |
|-----------|-------------------------------------|-----------------------------------|------------|-----|-----|-----------|-----|-----|------|
| | | | MIN | TYP | MAX | MIN | TYP | MAX | |
| I_{DD} | Supply current (four amplifiers) | $V_O = 2.5\text{ V}$, No load | 25°C | 0.8 | 1 | 0.8 | 1 | mA | |
| | | | Full range | | 1 | | 1 | | |

† Full range is -40°C to 125°C .

TLV2264I operating characteristics at specified free-air temperature, $V_{DD} = 5\text{ V}$

| PARAMETER | TEST CONDITIONS | T_A † | TLV2264I | | | TLV2264AI | | | UNIT | |
|-------------|--|--|---------------------------------------|------------|-------|-----------|--------|------------------------|------|------------------------------|
| | | | MIN | TYP | MAX | MIN | TYP | MAX | | |
| SR | Slew rate at unity gain $V_O = 1.4\text{ V}$ to 2.6 V , $C_L = 100\text{ pF}$ ‡ | $R_L = 50\text{ k}\Omega$ ‡ | 25°C | 0.35 | 0.55 | 0.35 | 0.55 | $\text{V}/\mu\text{s}$ | | |
| | | | Full range | 0.3 | | 0.3 | | | | |
| V_n | Equivalent input noise voltage | $f = 10\text{ Hz}$ | 25°C | 40 | | | 40 | | | $\text{nV}/\sqrt{\text{Hz}}$ |
| | | | $f = 1\text{ kHz}$ | 12 | | | 12 | | | |
| $V_{N(PP)}$ | Peak-to-peak equivalent input noise voltage | $f = 0.1\text{ Hz}$ to 1 Hz | 25°C | 0.7 | | | 0.7 | | | μV |
| | | | $f = 0.1\text{ Hz}$ to 10 Hz | 1.3 | | | 1.3 | | | |
| I_n | Equivalent input noise current | | 25°C | 0.6 | | | 0.6 | | | $\text{fA}/\sqrt{\text{Hz}}$ |
| THD + N | Total harmonic distortion plus noise $V_O = 0.5\text{ V}$ to 2.5 V , $f = 20\text{ kHz}$, $R_L = 50\text{ k}\Omega$ ‡ | $A_V = 1$ | 25°C | 0.017% | | | 0.017% | | | |
| | | | | $A_V = 10$ | 0.03% | | | 0.03% | | |
| | Gain-bandwidth product $f = 50\text{ kHz}$, $C_L = 100\text{ pF}$ ‡ | $R_L = 50\text{ k}\Omega$ ‡ | 25°C | 0.71 | | | 0.71 | | | MHz |
| BOM | Maximum output-swing bandwidth $V_{O(PP)} = 2\text{ V}$, $R_L = 50\text{ k}\Omega$ ‡ | $A_V = 1$, $C_L = 100\text{ pF}$ ‡ | 25°C | 185 | | | 185 | | | kHz |
| t_s | Settling time $A_V = -1$, Step = 0.5 V to 2.5 V , $R_L = 50\text{ k}\Omega$ ‡, $C_L = 100\text{ pF}$ ‡ | To 0.1% | 25°C | 6.4 | | | 6.4 | | | μs |
| | | To 0.01% | | 14.1 | | | 14.1 | | | |
| ϕ_m | Phase margin at unity gain $R_L = 50\text{ k}\Omega$ ‡, $C_L = 100\text{ pF}$ ‡ | | 25°C | 56° | | | 56° | | | |
| | | Gain margin | 25°C | 11 | | | 11 | | | dB |

† Full range is -40°C to 125°C .

‡ Referenced to 2.5 V

TLV226x, TLV226xA Advanced LinCMOS™ RAIL-TO-RAIL OPERATIONAL AMPLIFIERS

SLOS186B – FEBRUARY 1997 – REVISED MARCH 2001

TLV2262Q and TLV2262M electrical characteristics at specified free-air temperature, $V_{DD} = 3\text{ V}$ (unless otherwise noted)

| PARAMETER | TEST CONDITIONS | T_A † | TLV2262Q, TLV2262M | | | TLV2262AQ, TLV2262AM | | | UNIT | |
|--|---|------------------------------|-----------------------|-------------|------|-------------------------|-------------|---------------|------------------------------|--|
| | | | MIN | TYP | MAX | MIN | TYP | MAX | | |
| V_{IO} Input offset voltage | | 25°C | 300 | 2500 | | 300 | 950 | μV | | |
| | | Full range | | 3000 | | 1500 | | | | |
| αV_{IO} Temperature coefficient of input offset voltage | | 25°C to 125°C | 2 | | | 2 | | | $\mu\text{V}/^\circ\text{C}$ | |
| Input offset voltage long-term drift (see Note 4) | $V_{DD\pm} = \pm 1.5\text{ V}$, $V_{IC} = 0$, $V_O = 0$, $R_S = 50\ \Omega$ | 25°C | 0.003 | | | 0.003 | | | $\mu\text{V}/\text{mo}$ | |
| I_{IO} Input offset current | | 25°C | 0.5 | 60 | | 0.5 | 60 | pA | | |
| | 125°C | 800 | | | 800 | | | | | |
| I_{IB} Input bias current | | 25°C | 1 | | | 1 | | | pA | |
| | | 125°C | 800 | | | 800 | | | | |
| V_{ICR} Common-mode input voltage range | $R_S = 50\ \Omega$, $ V_{IO} \leq 5\text{ mV}$ | 25°C | 0 to 2 | -0.3 to 2.2 | | 0 to 2 | -0.3 to 2.2 | V | | |
| | | Full range | 0 to 1.7 | | | 0 to 1.7 | | | | |
| V_{OH} High-level output voltage | $I_{OH} = -20\ \mu\text{A}$ | 25°C | 2.99 | | | 2.99 | | | V | |
| | $I_{OH} = -100\ \mu\text{A}$ | 25°C | 2.85 | | | 2.85 | | | | |
| | | Full range | 2.82 | | | 2.82 | | | | |
| | $I_{OH} = -400\ \mu\text{A}$ | 25°C | 2.7 | | | 2.7 | | | | |
| Full range | | 2.55 | | | 2.55 | | | | | |
| V_{OL} Low-level output voltage | $V_{IC} = 1.5\text{ V}$, $I_{OL} = 50\ \mu\text{A}$ | 25°C | 10 | | | 10 | | | mV | |
| | $V_{IC} = 1.5\text{ V}$, $I_{OL} = 500\ \mu\text{A}$ | 25°C | 100 | 150 | | 100 | 150 | | | |
| | | Full range | 165 | | | 165 | | | | |
| | $V_{IC} = 1.5\text{ V}$, $I_{OL} = 1\text{ mA}$ | 25°C | 200 | 300 | | 200 | 300 | | | |
| Full range | | 300 | | | 300 | | | | | |
| A_{VD} Large-signal differential voltage amplification | $V_{IC} = 1.5\text{ V}$, $V_O = 1\text{ V to }2\text{ V}$ | $R_L = 50\ \text{k}\Omega$ ‡ | 25°C | 60 | 100 | | 60 | 100 | V/mV | |
| | | $R_L = 1\ \text{M}\Omega$ ‡ | Full range | 25 | | | 25 | | | |
| | | | 25°C | 100 | | | 100 | | | |
| $r_{i(d)}$ Differential input resistance | | 25°C | 10^{12} | | | 10^{12} | | | Ω | |
| $r_{i(c)}$ Common-mode input resistance | | 25°C | 10^{12} | | | 10^{12} | | | Ω | |
| $C_{i(c)}$ Common-mode input capacitance | $f = 10\ \text{kHz}$, P package | 25°C | 8 | | | 8 | | | pF | |
| Z_o Closed-loop output impedance | $f = 100\ \text{kHz}$, $A_V = 10$ | 25°C | 270 | | | 270 | | | Ω | |
| CMRR Common-mode rejection ratio | $V_{IC} = 0\text{ to }1.7\text{ V}$, $V_O = 1.5\text{ V}$, $R_S = 50\ \Omega$ | 25°C | 65 | 75 | | 65 | 77 | dB | | |
| | | Full range | 60 | | | 60 | | | | |
| k_{SVR} Supply voltage rejection ratio ($\Delta V_{DD}/\Delta V_{IO}$) | $V_{DD} = 2.7\text{ V to }8\text{ V}$, $V_{IC} = V_{DD}/2$, No load | 25°C | 80 | 95 | | 80 | 100 | dB | | |
| | | Full range | 80 | | | 80 | | | | |

† Full range is -40°C to 125°C for Q level part, -55°C to 125°C for M level part.

‡ Referenced to 1.5 V

NOTE 4: Typical values are based on the input offset voltage shift observed through 500 hours of operating life test at $T_A = 150^\circ\text{C}$ extrapolated to $T_A = 25^\circ\text{C}$ using the Arrhenius equation and assuming an activation energy of 0.96 eV.



TLV2262Q and TLV2262M electrical characteristics at specified free-air temperature, $V_{DD} = 3\text{ V}$ (unless otherwise noted) (continued)

| PARAMETER | TEST CONDITIONS | T_A † | TLV2262Q, TLV2262M | | | TLV2262AQ, TLV2262AM | | | UNIT |
|-------------------------|--------------------------------|------------|-----------------------|-----|-----|-------------------------|-----|---------------|------|
| | | | MIN | TYP | MAX | MIN | TYP | MAX | |
| I_{DD} Supply current | $V_O = 1.5\text{ V}$, No load | 25°C | 400 | 500 | | 400 | 500 | μA | |
| | | Full range | | 500 | | 500 | | | |

† Full range is -40°C to 125°C for Q level part, -55°C to 125°C for M level part.

TLV2262Q and TLV2262M operating characteristics at specified free-air temperature, $V_{DD} = 3\text{ V}$

| PARAMETER | TEST CONDITIONS | T_A † | TLV2262Q, TLV2262M | | | TLV2262AQ, TLV2262AM | | | UNIT |
|---|--|------------|-----------------------|----------------|-----|-------------------------|------|------------------------------|---------------|
| | | | MIN | TYP | MAX | MIN | TYP | MAX | |
| SR Slew rate at unity gain | $V_O = 0.5\text{ V}$ to 1.7 V , $R_L = 50\text{ k}\Omega$ ‡, $C_L = 100\text{ pF}$ ‡ | 25°C | 0.35 | 0.55 | | 0.35 | 0.55 | $\text{V}/\mu\text{s}$ | |
| | | Full range | 0.25 | | | 0.25 | | | |
| V_n Equivalent input noise voltage | $f = 10\text{ Hz}$ | 25°C | | 43 | | | 43 | $\text{nV}/\sqrt{\text{Hz}}$ | |
| | $f = 1\text{ kHz}$ | 25°C | | 12 | | | 12 | | |
| $V_{N(PP)}$ Peak-to-peak equivalent input noise voltage | $f = 0.1\text{ Hz}$ to 1 Hz | 25°C | | 0.6 | | | 0.6 | μV | |
| | $f = 0.1\text{ Hz}$ to 10 Hz | 25°C | | 1 | | | 1 | | |
| I_n Equivalent input noise current | | 25°C | | 0.6 | | | 0.6 | $\text{fA}/\sqrt{\text{Hz}}$ | |
| THD + N Total harmonic distortion plus noise | $V_O = 0.5\text{ V}$ to 2.5 V , $f = 20\text{ kHz}$, $R_L = 50\text{ k}\Omega$ ‡ | 25°C | | $A_V = 1$ | | 0.03% | | 0.03% | |
| | | | | $A_V = 10$ | | 0.05% | | 0.05% | |
| Gain-bandwidth product | $f = 1\text{ kHz}$, $C_L = 100\text{ pF}$ ‡ | 25°C | | 0.67 | | | 0.67 | MHz | |
| BOM Maximum output-swing bandwidth | $V_{O(PP)} = 1\text{ V}$, $R_L = 50\text{ k}\Omega$ ‡, $A_V = 1$, $C_L = 100\text{ pF}$ ‡ | 25°C | | 395 | | | 395 | kHz | |
| t_s Settling time | $A_V = -1$, Step = 1 V to 2 V , $R_L = 50\text{ k}\Omega$ ‡, $C_L = 100\text{ pF}$ ‡ | 25°C | | $T_o = 0.1\%$ | | 5.6 | | 5.6 | μs |
| | | | | $T_o = 0.01\%$ | | 12.5 | | 12.5 | |
| ϕ_m Phase margin at unity gain | $R_L = 50\text{ k}\Omega$ ‡, $C_L = 100\text{ pF}$ ‡ | 25°C | | 55° | | | 55° | | |
| Gain margin | | 25°C | | 11 | | | 11 | dB | |

† Full range is -40°C to 125°C for Q level part, -55°C to 125°C for M level part.

‡ Referenced to 1.5 V

TLV226x, TLV226xA Advanced LinCMOS™ RAIL-TO-RAIL OPERATIONAL AMPLIFIERS

SLOS186B – FEBRUARY 1997 – REVISED MARCH 2001

TLV2262Q and TLV2262M electrical characteristics at specified free-air temperature, $V_{DD} = 5\text{ V}$ (unless otherwise noted)

| PARAMETER | TEST CONDITIONS | T_A † | TLV2262Q, TLV2262M | | | TLV2262AQ, TLV2262AM | | | UNIT | |
|--|--|--|-----------------------|-----------|-------------|-------------------------|-----------|---------------|------------------------------|----------|
| | | | MIN | TYP | MAX | MIN | TYP | MAX | | |
| V_{IO} Input offset voltage | | 25°C | 300 | 2500 | | 300 | 950 | μV | | |
| | | Full range | | 3000 | | 1500 | | | | |
| α_{VIO} Temperature coefficient of input offset voltage | | 25°C to 125°C | 2 | | | 2 | | | $\mu\text{V}/^\circ\text{C}$ | |
| Input offset voltage long-term drift (see Note 4) | $V_{DD} = \pm 2.5\text{ V}$, $V_{IC} = 0$, $V_O = 0$, $R_S = 50\ \Omega$ | 25°C | 0.003 | | | 0.003 | | | $\mu\text{V}/\text{mo}$ | |
| I_{IO} Input offset current | | 25°C | 0.5 | 60 | | 0.5 | 60 | pA | | |
| | | 125°C | 800 | | | 800 | | | | |
| I_{IB} Input bias current | | 25°C | 1 | 60 | | 1 | 60 | pA | | |
| | | 125°C | 800 | | | 800 | | | | |
| V_{ICR} Common-mode input voltage range | | $ V_{IO} \leq 5\text{ mV}$, $R_S = 50\ \Omega$ | 25°C | 0 to 4 | -0.3 to 4.2 | | 0 to 4 | -0.3 to 4.2 | V | |
| | Full range | | 0 to 3.5 | | 0 to 3.5 | | | | | |
| V_{OH} High-level output voltage | $I_{OH} = -20\ \mu\text{A}$ | 25°C | 4.99 | | | 4.99 | | | V | |
| | | 25°C | 4.85 | 4.94 | | 4.85 | 4.94 | | | |
| | | Full range | 4.82 | | | 4.82 | | | | |
| | | 25°C | 4.7 | 4.85 | | 4.7 | 4.85 | | | |
| V_{OL} Low-level output voltage | $I_{OL} = 50\ \mu\text{A}$ | 25°C | 0.01 | | | 0.01 | | | V | |
| | | 25°C | 0.09 | 0.15 | | 0.09 | 0.15 | | | |
| | | Full range | 0.15 | | | 0.15 | | | | |
| | | 25°C | 0.2 | 0.3 | | 0.2 | 0.3 | | | |
| V_{OL} Low-level output voltage | $I_{OL} = 500\ \mu\text{A}$ | 25°C | 0.01 | | | 0.01 | | | V | |
| | | 25°C | 0.09 | 0.15 | | 0.09 | 0.15 | | | |
| | | Full range | 0.15 | | | 0.15 | | | | |
| | | 25°C | 0.2 | 0.3 | | 0.2 | 0.3 | | | |
| V_{OL} Low-level output voltage | $I_{OL} = 1\text{ mA}$ | 25°C | 0.01 | | | 0.01 | | | V | |
| | | 25°C | 0.09 | 0.15 | | 0.09 | 0.15 | | | |
| | | Full range | 0.15 | | | 0.15 | | | | |
| | | 25°C | 0.2 | 0.3 | | 0.2 | 0.3 | | | |
| A_{VD} Large-signal differential voltage amplification | $V_{IC} = 2.5\text{ V}$, $V_O = 1\text{ V to }4\text{ V}$ | $R_L = 50\text{ k}\Omega$ ‡ | 25°C | 80 | 170 | | 80 | 170 | V/mV | |
| | | | Full range | 50 | | | 50 | | | |
| | | | 25°C | 550 | | | 550 | | | |
| $r_{i(d)}$ Differential input resistance | | | 25°C | 10^{12} | | | 10^{12} | | | Ω |
| | | | 25°C | 10^{12} | | | 10^{12} | | | |
| $r_{i(c)}$ Common-mode input resistance | | | 25°C | 10^{12} | | | 10^{12} | | | Ω |
| $C_{i(c)}$ Common-mode input capacitance | $f = 10\text{ kHz}$, P package | | 25°C | 8 | | | 8 | | | pF |
| z_o Closed-loop output impedance | $f = 100\text{ kHz}$, $A_V = 10$ | | 25°C | 240 | | | 240 | | | Ω |
| CMRR Common-mode rejection ratio | $V_{IC} = 0\text{ to }2.7\text{ V}$, $V_O = 2.5\text{ V}$, $R_S = 50\ \Omega$ | 25°C | 70 | 83 | | 70 | 83 | dB | | |
| | | Full range | 70 | | | 70 | | | | |
| k_{SVR} Supply voltage rejection ratio ($\Delta V_{DD}/\Delta V_{IO}$) | $V_{DD} = 4.4\text{ V to }8\text{ V}$, $V_{IC} = V_{DD}/2$, No load | 25°C | 80 | 95 | | 80 | 95 | dB | | |
| | | Full range | 80 | | | 80 | | | | |

† Full range is -40°C to 125°C for Q level part, -55°C to 125°C for M level part.

‡ Referenced to 2.5 V

NOTE 4: Typical values are based on the input offset voltage shift observed through 500 hours of operating life test at $T_A = 150^\circ\text{C}$ extrapolated to $T_A = 25^\circ\text{C}$ using the Arrhenius equation and assuming an activation energy of 0.96 eV.



TLV226x, TLV226xA
Advanced LinCMOS™ RAIL-TO-RAIL
OPERATIONAL AMPLIFIERS

SLOS186B – FEBRUARY 1997 – REVISED MARCH 2001

TLV2262Q and TLV2262M electrical characteristics at specified free-air temperature, $V_{DD} = 5\text{ V}$ (unless otherwise noted) (continued)

| PARAMETER | TEST CONDITIONS | T_A † | TLV2262Q, TLV2262M | | | TLV2262AQ, TLV2262AM | | | UNIT |
|-------------------------|--------------------------------|------------|-----------------------|-----|-----|-------------------------|-----|---------------|------|
| | | | MIN | TYP | MAX | MIN | TYP | MAX | |
| I_{DD} Supply current | $V_O = 2.5\text{ V}$, No load | 25°C | 400 | 500 | | 400 | 500 | μA | |
| | | Full range | | 500 | | | 500 | | |

† Full range is -40°C to 125°C for Q level part, -55°C to 125°C for M level part.

TLV2262Q and TLV2262M operating characteristics at specified free-air temperature, $V_{DD} = 5\text{ V}$

| PARAMETER | TEST CONDITIONS | T_A † | TLV2262Q, TLV2262M | | | TLV2262AQ, TLV2262AM | | | UNIT |
|---|---|------------|-----------------------|------|--------|-------------------------|--------|------------------------------|---------------|
| | | | MIN | TYP | MAX | MIN | TYP | MAX | |
| SR Slew rate at unity gain | $V_O = 0.5\text{ V}$ to 3.5 V , $C_L = 100\text{ pF}^\ddagger$, $R_L = 50\text{ k}\Omega^\ddagger$ | 25°C | 0.35 | 0.55 | | 0.35 | 0.55 | $\text{V}/\mu\text{s}$ | |
| | | Full range | 0.25 | | | 0.25 | | | |
| V_n Equivalent input noise voltage | $f = 10\text{ Hz}$ $f = 1\text{ kHz}$ | 25°C | 40 | | | 40 | | $\text{nV}/\sqrt{\text{Hz}}$ | |
| | | 25°C | 12 | | | 12 | | | |
| $V_{N(PP)}$ Peak-to-peak equivalent input noise voltage | $f = 0.1\text{ Hz}$ to 1 Hz $f = 0.1\text{ Hz}$ to 10 Hz | 25°C | 0.7 | | | 0.7 | | μV | |
| | | 25°C | 1.3 | | | 1.3 | | | |
| I_n Equivalent input noise current | | 25°C | 0.6 | | | 0.6 | | $\text{fA}/\sqrt{\text{Hz}}$ | |
| THD + N Total harmonic distortion plus noise | $V_O = 0.5\text{ V}$ to 2.5 V , $f = 20\text{ kHz}$, $R_L = 50\text{ k}\Omega^\ddagger$ | 25°C | $A_V = 1$ | | 0.017% | | 0.017% | | |
| | | | $A_V = 10$ | | 0.03% | | 0.03% | | |
| Gain-bandwidth product | $f = 50\text{ kHz}$, $C_L = 100\text{ pF}^\ddagger$, $R_L = 50\text{ k}\Omega^\ddagger$ | 25°C | 0.71 | | | 0.71 | | MHz | |
| B_{OM} Maximum output-swing bandwidth | $V_{O(PP)} = 2\text{ V}$, $R_L = 50\text{ k}\Omega^\ddagger$, $A_V = 1$, $C_L = 100\text{ pF}^\ddagger$ | 25°C | 185 | | | 185 | | kHz | |
| t_s Settling time | $A_V = -1$, Step = 0.5 V to 2.5 V , $R_L = 50\text{ k}\Omega^\ddagger$, $C_L = 100\text{ pF}^\ddagger$ | 25°C | To 0.1% | | 6.4 | | 6.4 | | μs |
| | | | To 0.01% | | 14.1 | | 14.1 | | |
| ϕ_m Phase margin at unity gain | $R_L = 50\text{ k}\Omega^\ddagger$, $C_L = 100\text{ pF}^\ddagger$ | 25°C | 56° | | | 56° | | | |
| | | 25°C | 11 | | | 11 | | dB | |

† Full range is -40°C to 125°C for Q level part, -55°C to 125°C for M level part.

‡ Referenced to 2.5 V



TLV226x, TLV226xA Advanced LinCMOS™ RAIL-TO-RAIL OPERATIONAL AMPLIFIERS

SLOS186B – FEBRUARY 1997 – REVISED MARCH 2001

TLV2264Q and TLV2264M electrical characteristics at specified free-air temperature, $V_{DD} = 3\text{ V}$ (unless otherwise noted)

| PARAMETER | TEST CONDITIONS | T_A † | TLV2264Q, TLV2264M | | | TLV2264AQ, TLV2264AM | | | UNIT | | |
|--|--|---------------|------------------------------|-------------|-----------|-------------------------|-------------|---------------|------------------------------|---------------|----------|
| | | | MIN | TYP | MAX | MIN | TYP | MAX | | | |
| V_{IO} Input offset voltage | | 25°C | 300 | 2500 | | 300 | 950 | μV | | | |
| | | Full range | | | 3000 | | 1500 | | | | |
| α_{VIO} Temperature coefficient of input offset voltage | $V_{DD} \pm = \pm 1.5\text{ V}$, $V_{IC} = 0$, $V_O = 0$, $R_S = 50\ \Omega$ | 25°C to 125°C | 2 | | | 2 | | | $\mu\text{V}/^\circ\text{C}$ | | |
| Input offset voltage long-term drift (see Note 4) | | 25°C | 0.003 | | | 0.003 | | | $\mu\text{V}/\text{mo}$ | | |
| I_{IO} Input offset current | | 25°C | 0.5 | 60 | | 0.5 | 60 | pA | | | |
| | | 125°C | | | 800 | | 800 | | | | |
| I_{IB} Input bias current | 25°C | 1 | | | 1 | | | pA | | | |
| | 125°C | 800 | | | 800 | | | | | | |
| V_{ICR} Common-mode input voltage range | $R_S = 50\ \Omega$, $ V_{IO} \leq 5\text{ mV}$ | 25°C | 0 to 2 | -0.3 to 2.2 | | 0 to 2 | -0.3 to 2.2 | V | | | |
| | | Full range | 0 to 1.7 | | | 0 to 1.7 | | | | | |
| V_{OH} High-level output voltage | $I_{OH} = -20\ \mu\text{A}$ | 25°C | 2.99 | | | 2.99 | | | V | | |
| | | 25°C | 2.85 | | | 2.85 | | | | | |
| | | Full range | 2.82 | | | 2.82 | | | | | |
| | | 25°C | 2.7 | | | 2.7 | | | | | |
| V_{OL} Low-level output voltage | $V_{IC} = 1.5\text{ V}$, $I_{OL} = 50\ \mu\text{A}$ | 25°C | 10 | | | 10 | | | mV | | |
| | | 25°C | 100 | 150 | | 100 | 150 | | | | |
| | | Full range | 150 | | | 150 | | | | | |
| | | 25°C | 200 | 300 | | 200 | 300 | | | | |
| V_{OL} Low-level output voltage | $V_{IC} = 1.5\text{ V}$, $I_{OL} = 500\ \mu\text{A}$ | 25°C | 100 | | | 100 | | | mV | | |
| | | 25°C | 100 | 150 | | 100 | 150 | | | | |
| | | Full range | 150 | | | 150 | | | | | |
| | | 25°C | 200 | 300 | | 200 | 300 | | | | |
| V_{OL} Low-level output voltage | $V_{IC} = 1.5\text{ V}$, $I_{OL} = 1\text{ mA}$ | 25°C | 200 | | | 200 | | | mV | | |
| | | 25°C | 200 | 300 | | 200 | 300 | | | | |
| | | Full range | 300 | | | 300 | | | | | |
| | | 25°C | 200 | 300 | | 200 | 300 | | | | |
| A_{VD} Large-signal differential voltage amplification | $V_{IC} = 1.5\text{ V}$, $V_O = 1\text{ V to }2\text{ V}$ | | $R_L = 50\ \text{k}\Omega$ ‡ | 25°C | 60 | 100 | | 60 | 100 | V/mV | |
| | | | | Full range | 25 | | | 25 | | | |
| | | | | 25°C | 100 | | | 100 | | | |
| $r_{i(d)}$ Differential input resistance | | | | 25°C | 10^{12} | | | 10^{12} | | | Ω |
| | | | | 25°C | 10^{12} | | | 10^{12} | | | |
| | | | | 25°C | 10^{12} | | | 10^{12} | | | |
| $r_{i(c)}$ Common-mode input resistance | | | | 25°C | 10^{12} | | | 10^{12} | | | Ω |
| | | | | 25°C | 10^{12} | | | 10^{12} | | | |
| | | | | 25°C | 10^{12} | | | 10^{12} | | | |
| $C_{i(c)}$ Common-mode input capacitance | $f = 10\text{ kHz}$, N package | 25°C | 8 | | | 8 | | | pF | | |
| z_o Closed-loop output impedance | $f = 100\text{ kHz}$, $A_V = 10$ | 25°C | 270 | | | 270 | | | Ω | | |
| CMRR Common-mode rejection ratio | $V_{IC} = 0\text{ to }1.7\text{ V}$, $V_O = 1.5\text{ V}$, $R_S = 50\ \Omega$ | 25°C | 65 | 75 | | 65 | 77 | dB | | | |
| | | Full range | 60 | | | 60 | | | | | |
| k_{SVR} Supply voltage rejection ratio ($\Delta V_{DD}/\Delta V_{IO}$) | $V_{DD} = 2.7\text{ V to }8\text{ V}$, $V_{IC} = V_{DD}/2$, No load | 25°C | 80 | 95 | | 80 | 100 | dB | | | |
| | | Full range | 80 | | | 80 | | | | | |

† Full range is -40°C to 125°C for Q level part, -55°C to 125°C for M level part.

‡ Referenced to 1.5 V

NOTE 4: Typical values are based on the input offset voltage shift observed through 500 hours of operating life test at $T_A = 150^\circ\text{C}$ extrapolated to $T_A = 25^\circ\text{C}$ using the Arrhenius equation and assuming an activation energy of 0.96 eV.



TLV2264Q and TLV2264M electrical characteristics at specified free-air temperature, $V_{DD} = 3\text{ V}$ (unless otherwise noted) (continued)

| PARAMETER | TEST CONDITIONS | T_A † | TLV2264Q, TLV2264M | | | TLV2264AQ, TLV2264AM | | | UNIT |
|-----------|--|------------|-----------------------|-----|-----|-------------------------|-----|-----|------|
| | | | MIN | TYP | MAX | MIN | TYP | MAX | |
| I_{DD} | Supply current (four amplifiers) $V_O = 1.5\text{ V}$, No load | 25°C | 0.8 | | 1 | 0.8 | | 1 | mA |
| | | Full range | | | 1 | | | 1 | |

† Full range is -40°C to 125°C for Q level part, -55°C to 125°C for M level part.

TLV2264Q and TLV2264M operating characteristics at specified free-air temperature, $V_{DD} = 3\text{ V}$

| PARAMETER | TEST CONDITIONS | T_A † | TLV2264Q, TLV2264M | | | TLV2264AQ, TLV2264AM | | | UNIT |
|-------------|---|------------|-----------------------|------|-------|-------------------------|-------|-----|------------------------------|
| | | | MIN | TYP | MAX | MIN | TYP | MAX | |
| SR | Slew rate at unity gain $V_O = 0.5\text{ V to }1.7\text{ V}$, $R_L = 50\text{ k}\Omega^\ddagger$, $C_L = 100\text{ pF}^\ddagger$ | 25°C | 0.35 | 0.55 | | 0.35 | 0.55 | | $\text{V}/\mu\text{s}$ |
| | | Full range | 0.25 | | | 0.25 | | | |
| V_n | Equivalent input noise voltage $f = 10\text{ Hz}$ $f = 1\text{ kHz}$ | 25°C | 43 | | | 43 | | | $\text{nV}/\sqrt{\text{Hz}}$ |
| | | 25°C | 12 | | | 12 | | | |
| $V_{N(PP)}$ | Peak-to-peak equivalent input noise voltage $f = 0.1\text{ Hz to }1\text{ Hz}$ $f = 0.1\text{ Hz to }10\text{ Hz}$ | 25°C | 0.6 | | | 0.6 | | | μV |
| | | 25°C | 1 | | | 1 | | | |
| I_n | Equivalent input noise current | 25°C | 0.6 | | | 0.6 | | | $\text{fA}/\sqrt{\text{Hz}}$ |
| THD + N | Total harmonic distortion plus noise $V_O = 0.5\text{ V to }2.5\text{ V}$, $f = 20\text{ kHz}$, $R_L = 50\text{ k}\Omega^\ddagger$ | 25°C | $A_V = 1$ | | 0.03% | | 0.03% | | |
| | | | $A_V = 10$ | | 0.05% | | 0.05% | | |
| | Gain-bandwidth product $f = 1\text{ kHz}$, $C_L = 100\text{ pF}^\ddagger$ | 25°C | 0.67 | | | 0.67 | | | MHz |
| B_{OM} | Maximum output-swing bandwidth $V_{O(PP)} = 1\text{ V}$, $R_L = 50\text{ k}\Omega^\ddagger$, $A_V = 1$, $C_L = 100\text{ pF}^\ddagger$ | 25°C | 395 | | | 395 | | | kHz |
| t_s | Settling time $A_V = -1$, Step = $1\text{ V to }2\text{ V}$, $R_L = 50\text{ k}\Omega^\ddagger$, $C_L = 100\text{ pF}^\ddagger$ | 25°C | To 0.1% | | 5.6 | | 5.6 | | μs |
| | | | To 0.01% | | 12.5 | | 12.5 | | |
| ϕ_m | Phase margin at unity gain $R_L = 50\text{ k}\Omega^\ddagger$, $C_L = 100\text{ pF}^\ddagger$ | 25°C | 55° | | | 55° | | | |
| | | 25°C | 11 | | | 11 | | | |

† Full range is -40°C to 125°C for Q level part, -55°C to 125°C for M level part.

‡ Referenced to 1.5 V

TLV226x, TLV226xA
Advanced LinCMOS™ RAIL-TO-RAIL
OPERATIONAL AMPLIFIERS

SLOS186B – FEBRUARY 1997 – REVISED MARCH 2001

TLV2264Q and TLV2264M electrical characteristics at specified free-air temperature, $V_{DD} = 5\text{ V}$ (unless otherwise noted)

| PARAMETER | TEST CONDITIONS | T_A † | TLV2264Q, TLV2264M | | | TLV2264AQ, TLV2264AM | | | UNIT |
|--|--|-----------------------------|-----------------------|-------------|----------|-------------------------|-------------|----------|------------------------------|
| | | | MIN | TYP | MAX | MIN | TYP | MAX | |
| V_{IO} Input offset voltage | | 25°C | 300 | | 2500 | 300 | | 950 | μV |
| | | Full range | 3000 | | | 1500 | | | |
| α_{VIO} Temperature coefficient of input offset voltage | $V_{DD} \pm = \pm 2.5\text{ V}$, $V_{IC} = 0$, $V_O = 0$, $R_S = 50\ \Omega$ | 25°C to 125°C | 2 | | | 2 | | | $\mu\text{V}/^\circ\text{C}$ |
| Input offset voltage long-term drift (see Note 4) | | 25°C | 0.003 | | | 0.003 | | | $\mu\text{V}/\text{mo}$ |
| I_{IO} Input offset current | | 25°C | 0.5 | | 60 | 0.5 | | 60 | pA |
| | | 125°C | 800 | | | 800 | | | |
| I_{IB} Input bias current | 25°C | 1 | | 60 | 1 | | 60 | pA | |
| | 125°C | 800 | | | 800 | | | | |
| V_{ICR} Common-mode input voltage range | $ V_{IO} \leq 5\text{ mV}$, $R_S = 50\ \Omega$ | 25°C | 0 to 4 | -0.3 to 4.2 | | 0 to 4 | -0.3 to 4.2 | V | |
| | | Full range | 0 to 3.5 | | 0 to 3.5 | | | | |
| V_{OH} High-level output voltage | $I_{OH} = -20\ \mu\text{A}$ | 25°C | 4.99 | | 4.99 | | V | | |
| | | 25°C | 4.85 | 4.94 | 4.85 | 4.94 | | | |
| | | Full range | 4.82 | | | 4.82 | | | |
| | | 25°C | 4.7 | 4.85 | 4.7 | 4.85 | | | |
| V_{OL} Low-level output voltage | $V_{IC} = 2.5\text{ V}$, $I_{OL} = 50\ \mu\text{A}$ | 25°C | 0.01 | | | 0.01 | | V | |
| | | 25°C | 0.09 | 0.15 | 0.09 | 0.15 | | | |
| | | Full range | 0.15 | | | 0.15 | | | |
| | | 25°C | 0.2 | 0.3 | 0.2 | 0.3 | | | |
| V_{OL} Low-level output voltage | $V_{IC} = 2.5\text{ V}$, $I_{OL} = 500\ \mu\text{A}$ | 25°C | 0.01 | | | 0.01 | | V | |
| | | 25°C | 0.09 | 0.15 | 0.09 | 0.15 | | | |
| | | Full range | 0.15 | | | 0.15 | | | |
| | | 25°C | 0.2 | 0.3 | 0.2 | 0.3 | | | |
| V_{OL} Low-level output voltage | $V_{IC} = 2.5\text{ V}$, $I_{OL} = 1\text{ mA}$ | 25°C | 0.01 | | | 0.01 | | V | |
| | | 25°C | 0.09 | 0.15 | 0.09 | 0.15 | | | |
| | | Full range | 0.15 | | | 0.15 | | | |
| | | 25°C | 0.2 | 0.3 | 0.2 | 0.3 | | | |
| A_{VD} Large-signal differential voltage amplification | $V_{IC} = 2.5\text{ V}$, $V_O = 1\text{ V to }4\text{ V}$ | $R_L = 50\text{ k}\Omega$ ‡ | 25°C | 80 | 170 | 80 | 170 | V/mV | |
| | | | Full range | 50 | | | 50 | | |
| | | $R_L = 1\text{ M}\Omega$ ‡ | 25°C | 550 | | | 550 | | |
| $r_{i(d)}$ Differential input resistance | | 25°C | 10^{12} | | | 10^{12} | | Ω | |
| $r_{i(c)}$ Common-mode input resistance | | 25°C | 10^{12} | | | 10^{12} | | Ω | |
| $C_{i(c)}$ Common-mode input capacitance | f = 10 kHz, N package | 25°C | 8 | | | 8 | | pF | |
| z_o Closed-loop output impedance | f = 100 kHz, $A_V = 10$ | 25°C | 240 | | | 240 | | Ω | |
| CMRR Common-mode rejection ratio | $V_{IC} = 0\text{ to }2.7\text{ V}$, $V_O = 2.5\text{ V}$, $R_S = 50\ \Omega$ | 25°C | 70 | 83 | 70 | 83 | dB | | |
| | | Full range | 70 | | | 70 | | | |
| k_{SVR} Supply voltage rejection ratio ($\Delta V_{DD}/\Delta V_{IO}$) | $V_{DD} = 4.4\text{ V to }8\text{ V}$, $V_{IC} = V_{DD}/2$, No load | 25°C | 80 | 95 | 80 | 95 | dB | | |
| | | Full range | 80 | | | 80 | | | |

† Full range is -40°C to 125°C for Q level part, -55°C to 125°C for M level part.

‡ Referenced to 2.5 V

NOTE 4: Typical values are based on the input offset voltage shift observed through 500 hours of operating life test at $T_A = 150^\circ\text{C}$ extrapolated to $T_A = 25^\circ\text{C}$ using the Arrhenius equation and assuming an activation energy of 0.96 eV.



TLV2264Q and TLV2264M electrical characteristics at specified free-air temperature, $V_{DD} = 5\text{ V}$ (unless otherwise noted) (continued)

| PARAMETER | TEST CONDITIONS | T_A † | TLV2264Q, TLV2264M | | | TLV2264AQ, TLV2264AM | | | UNIT |
|-----------|--|------------|--------------------|-----|-----|----------------------|-----|-----|------|
| | | | MIN | TYP | MAX | MIN | TYP | MAX | |
| I_{DD} | Supply current (four amplifiers) $V_O = 2.5\text{ V}$, No load | 25°C | 0.8 | | 1 | 0.8 | | 1 | mA |
| | | Full range | | | 1 | | | 1 | |

† Full range is -40°C to 125°C for Q level part, -55°C to 125°C for M level part.

TLV2264Q and TLV2264M operating characteristics at specified free-air temperature, $V_{DD} = 5\text{ V}$

| PARAMETER | TEST CONDITIONS | T_A † | TLV2264Q, TLV2264M | | | TLV2264AQ, TLV2264AM | | | UNIT |
|-------------|--|---------------------------------------|--------------------|------|--------|----------------------|------|-----|------------------------|
| | | | MIN | TYP | MAX | MIN | TYP | MAX | |
| SR | Slew rate at unity gain $V_O = 0.5\text{ V}$ to 3.5 V , $R_L = 50\text{ k}\Omega$ ‡, $C_L = 100\text{ pF}$ ‡ | 25°C | 0.35 | 0.55 | | 0.35 | 0.55 | | V/ μs |
| | | Full range | 0.25 | | | 0.25 | | | |
| V_n | Equivalent input noise voltage | $f = 10\text{ Hz}$ | 40 | | 40 | | | | nV/ $\sqrt{\text{Hz}}$ |
| | | $f = 1\text{ kHz}$ | 12 | | 12 | | | | |
| $V_{N(PP)}$ | Peak-to-peak equivalent input noise voltage | $f = 0.1\text{ Hz}$ to 1 Hz | 0.7 | | 0.7 | | | | μV |
| | | $f = 0.1\text{ Hz}$ to 10 Hz | 1.3 | | 1.3 | | | | |
| I_n | Equivalent input noise current | 25°C | 0.6 | | 0.6 | | | | fA/ $\sqrt{\text{Hz}}$ |
| THD + N | Total harmonic distortion plus noise $V_O = 0.5\text{ V}$ to 2.5 V , $f = 20\text{ kHz}$, $R_L = 50\text{ k}\Omega$ ‡ | $A_V = 1$ | 0.017% | | 0.017% | | | | |
| | | $A_V = 10$ | 0.03% | | 0.03% | | | | |
| | Gain-bandwidth product $f = 50\text{ kHz}$, $C_L = 100\text{ pF}$ ‡ | $R_L = 50\text{ k}\Omega$ ‡, 25°C | 0.71 | | 0.71 | | | | MHz |
| BOM | Maximum output-swing bandwidth $V_{O(PP)} = 2\text{ V}$, $R_L = 50\text{ k}\Omega$ ‡, $A_V = 1$, $C_L = 100\text{ pF}$ ‡ | 25°C | 185 | | 185 | | | | kHz |
| t_s | Settling time $A_V = -1$, Step = 0.5 V to 2.5 V , $R_L = 50\text{ k}\Omega$ ‡, $C_L = 100\text{ pF}$ ‡ | To 0.1% | 6.4 | | 6.4 | | | | μs |
| | | To 0.01% | 14.1 | | 14.1 | | | | |
| ϕ_m | Phase margin at unity gain $R_L = 50\text{ k}\Omega$ ‡, $C_L = 100\text{ pF}$ ‡ | 25°C | 56° | | 56° | | | | |
| | | 25°C | 11 | | 11 | | | | |
| | Gain margin | 25°C | 11 | | 11 | | | | dB |

† Full range is -40°C to 125°C for Q level part, -55°C to 125°C for M level part.

‡ Referenced to 2.5 V

TLV226x, TLV226xA
Advanced LinCMOS™ RAIL-TO-RAIL
OPERATIONAL AMPLIFIERS

SLOS186B – FEBRUARY 1997 – REVISED MARCH 2001

TYPICAL CHARACTERISTICS

Table of Graphs

| | | FIGURE |
|-----------------|---|---|
| V_{IO} | Input offset voltage | Distribution vs Common-mode voltage 2 – 5 6, 7 |
| αV_{IO} | Input offset voltage temperature coefficient | Distribution 8 – 11 |
| I_{IB}/I_{IO} | Input bias and input offset currents | vs Free-air temperature 12 |
| V_I | Input voltage | vs Supply voltage vs Free-air temperature 13 14 |
| V_{OH} | High-level output voltage | vs High-level output current 15, 18 |
| V_{OL} | Low-level output voltage | vs Low-level output current 16, 17, 19 |
| $V_{O(PP)}$ | Maximum peak-to-peak output voltage | vs Frequency 20 |
| I_{OS} | Short-circuit output current | vs Supply voltage vs Free-air temperature 21 22 |
| V_{ID} | Differential input voltage | vs Output voltage 23, 24 |
| A_{VD} | Differential voltage amplification | vs Load resistance 25 |
| A_{VD} | Large-signal differential voltage amplification | vs Frequency vs Free-air temperature 26, 27 28, 29 |
| z_o | Output impedance | vs Frequency 30, 31 |
| $CMRR$ | Common-mode rejection ratio | vs Frequency vs Free-air temperature 32 33 |
| k_{SVR} | Supply-voltage rejection ratio | vs Frequency vs Free-air temperature 34, 35 36, 37 |
| I_{DD} | Supply current | vs Free-air temperature 38, 39 |
| SR | Slew rate | vs Load capacitance vs Free-air temperature 40 41 |
| V_O | Inverting large-signal pulse response | 42, 43 |
| V_O | Voltage-follower large-signal pulse response | 44, 45 |
| V_O | Inverting small-signal pulse response | 46, 47 |
| V_O | Voltage-follower small-signal pulse response | 48, 49 |
| V_n | Equivalent input noise voltage | vs Frequency 50, 51 |
| | Input noise voltage | Over a 10-second period 52 |
| | Integrated noise voltage | vs Frequency 53 |
| $THD + N$ | Total harmonic distortion plus noise | vs Frequency 54 |
| | Gain-bandwidth product | vs Supply voltage vs Free-air temperature 55 56 |
| ϕ_m | Phase margin | vs Frequency vs Load capacitance 26, 27 57 |
| | Gain margin | vs Load capacitance 58 |
| B_1 | Unity-gain bandwidth | vs Load capacitance 59 |
| | Overestimation of phase margin | vs Load capacitance 60 |



TYPICAL CHARACTERISTICS

DISTRIBUTION OF TLV2262
 INPUT OFFSET VOLTAGE

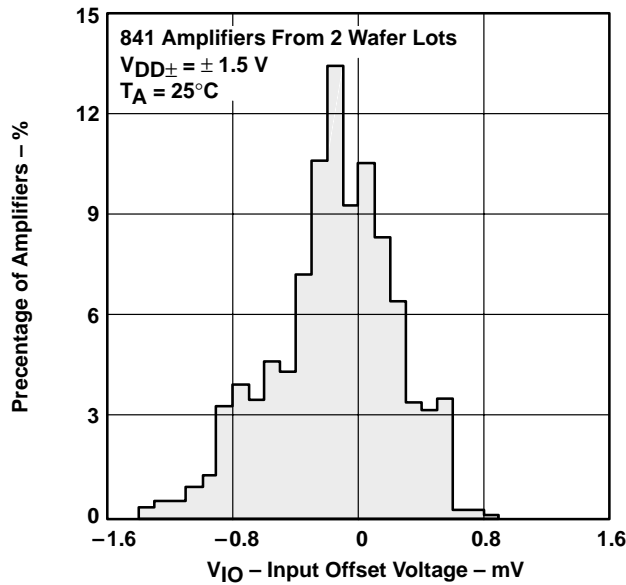

Figure 2

DISTRIBUTION OF TLV2262
 INPUT OFFSET VOLTAGE

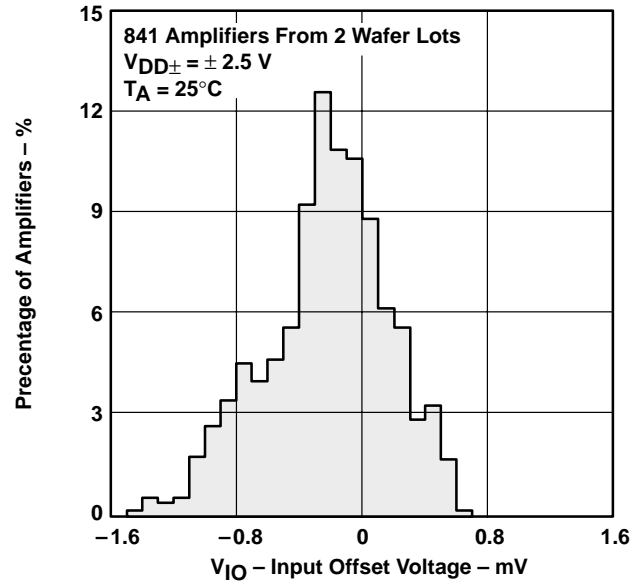

Figure 3

DISTRIBUTION OF TLV2264
 INPUT OFFSET VOLTAGE

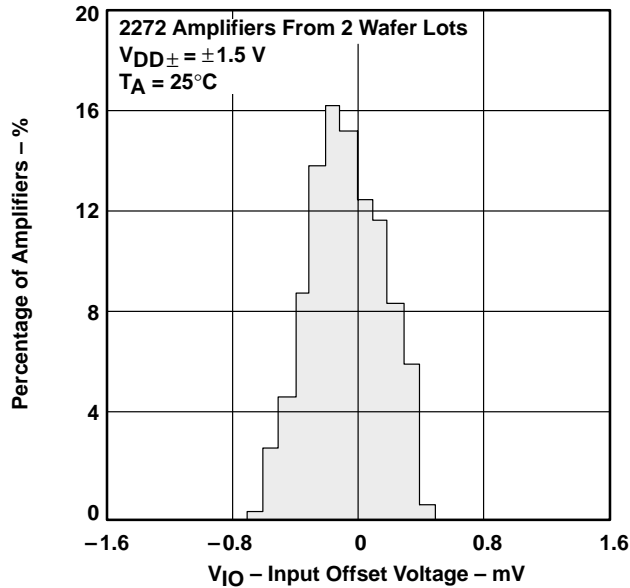

Figure 4

DISTRIBUTION OF TLV2264
 INPUT OFFSET VOLTAGE

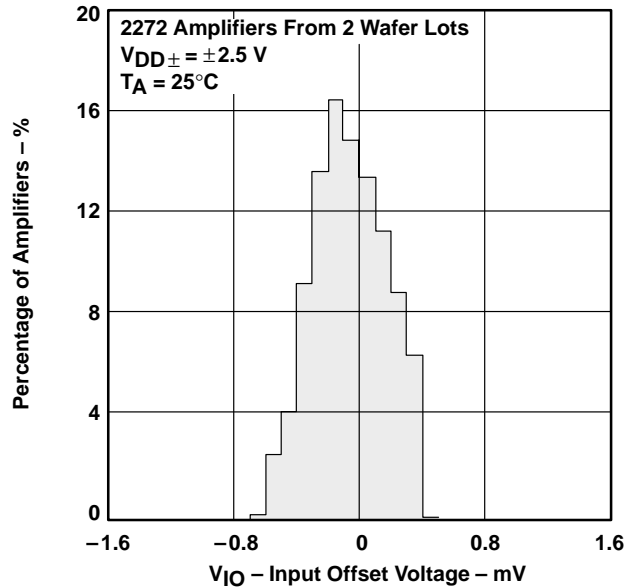

Figure 5

TYPICAL CHARACTERISTICS

**INPUT OFFSET VOLTAGE†
 vs
 COMMON-MODE INPUT VOLTAGE**

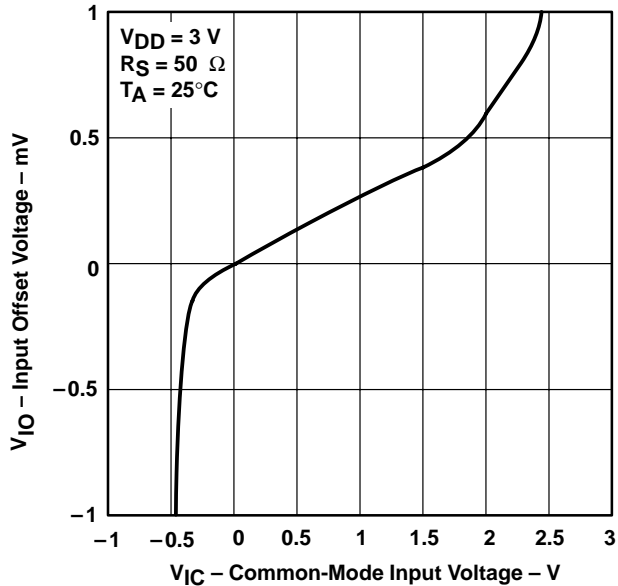

Figure 6

**INPUT OFFSET VOLTAGE†
 vs
 COMMON-MODE INPUT VOLTAGE**

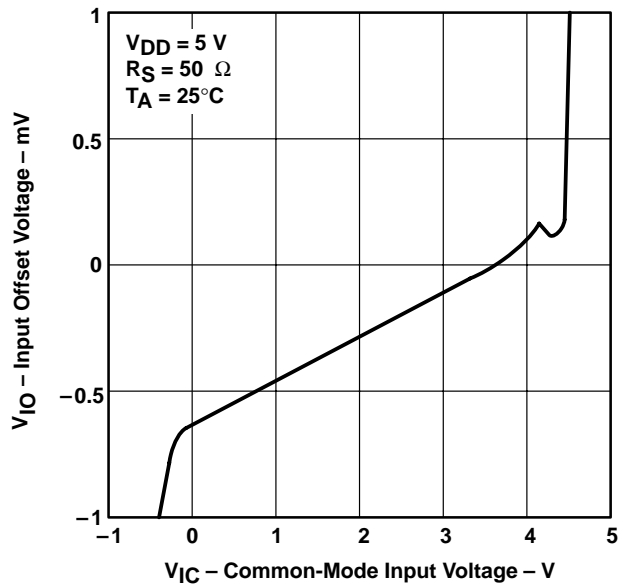

Figure 7

**DISTRIBUTION OF TLV2262 INPUT OFFSET
 VOLTAGE TEMPERATURE COEFFICIENT**

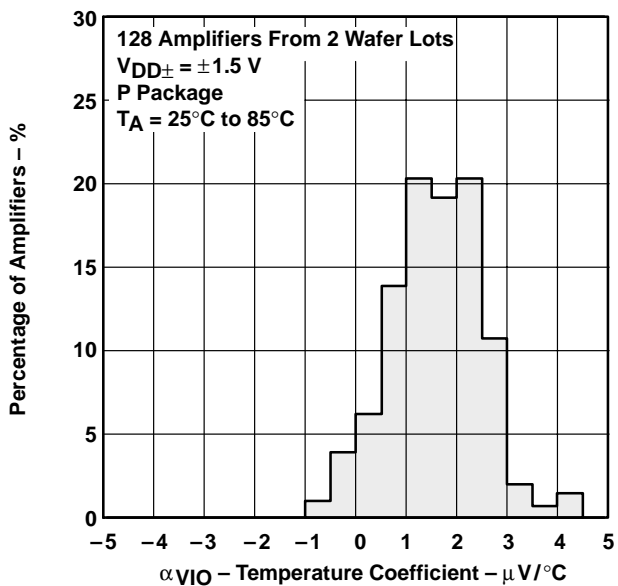

Figure 8

**DISTRIBUTION OF TLV2262 INPUT OFFSET
 VOLTAGE TEMPERATURE COEFFICIENT**

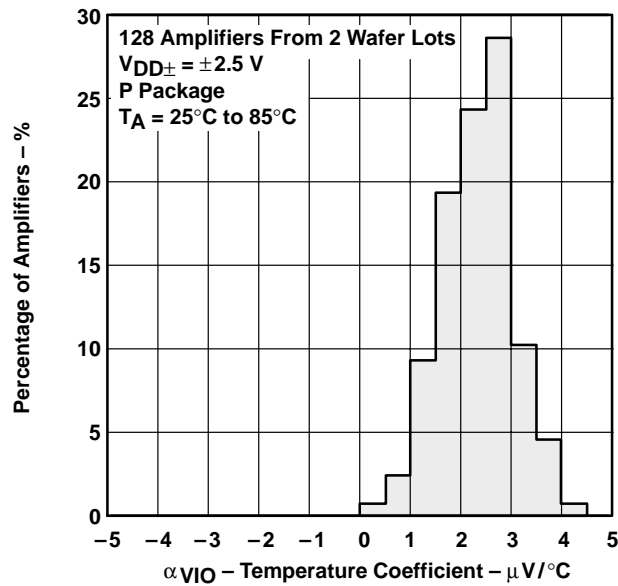

Figure 9

† For all curves where $V_{DD} = 5\text{ V}$, all loads are referenced to 2.5 V. For all curves where $V_{DD} = 3\text{ V}$, all loads are referenced to 1.5 V.

TYPICAL CHARACTERISTICS

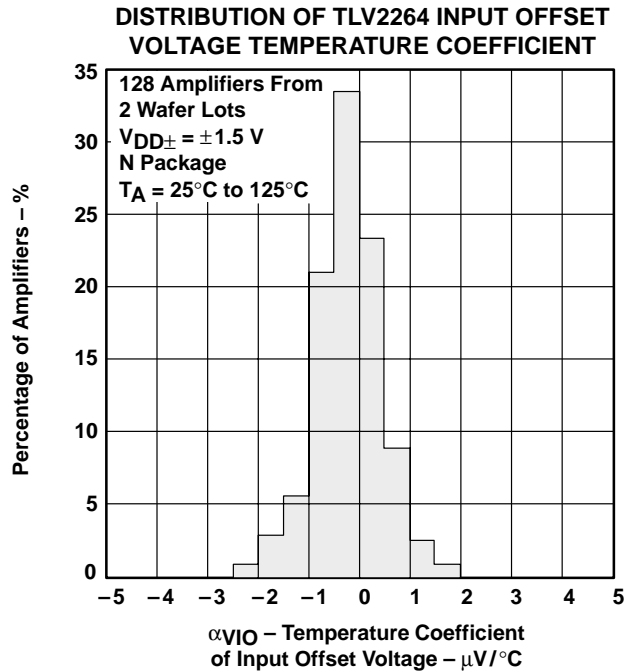

Figure 10

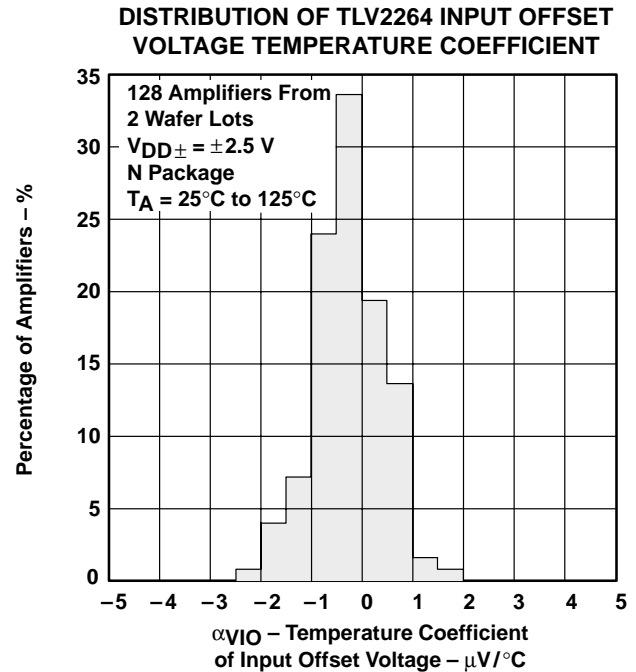

Figure 11

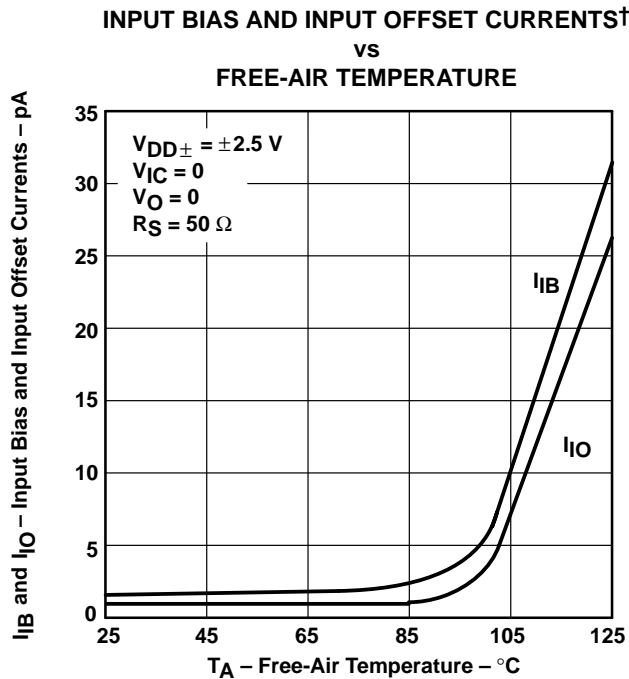

Figure 12

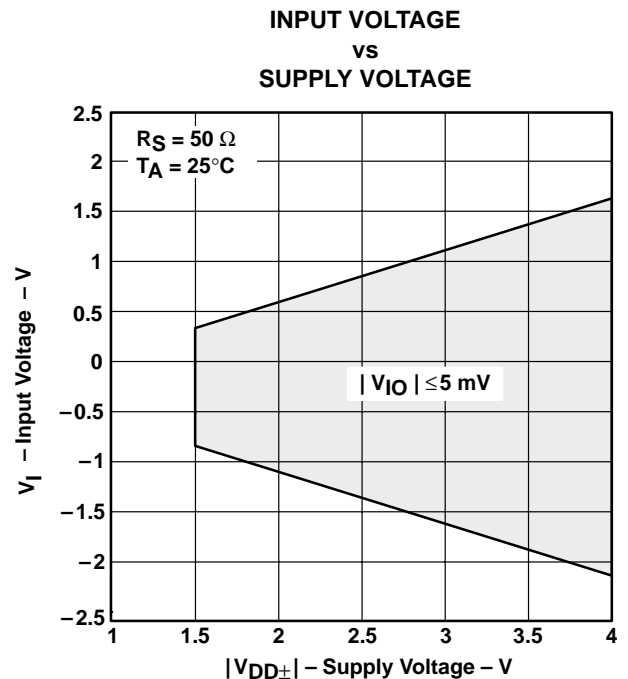

Figure 13

† Data at high and low temperatures are applicable only within the rated operating free-air temperature ranges of the various devices.

TYPICAL CHARACTERISTICS

**INPUT VOLTAGE†
vs
FREE-AIR TEMPERATURE**

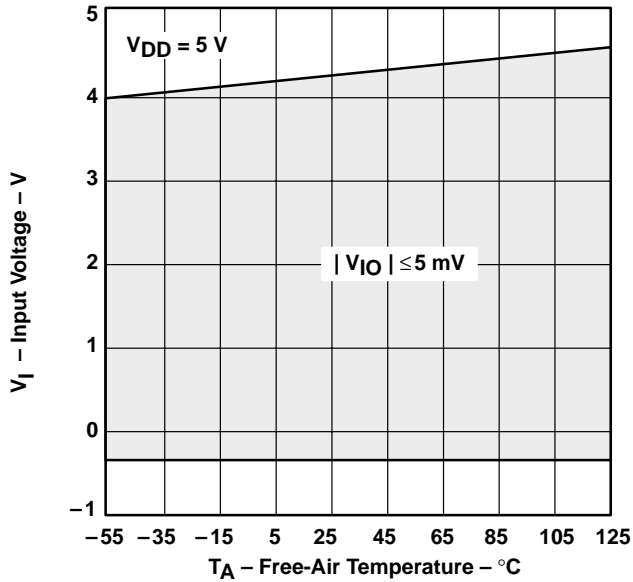

Figure 14

**HIGH-LEVEL OUTPUT VOLTAGE†
vs
HIGH-LEVEL OUTPUT CURRENT**

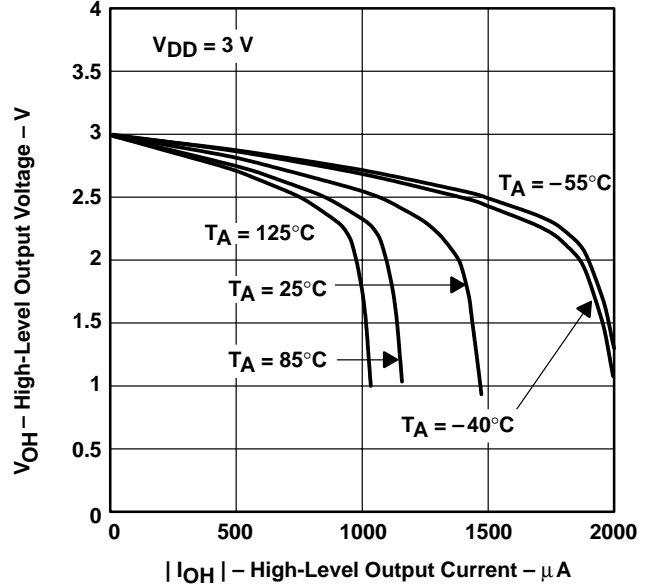

Figure 15

**LOW-LEVEL OUTPUT VOLTAGE†
vs
LOW-LEVEL OUTPUT CURRENT**

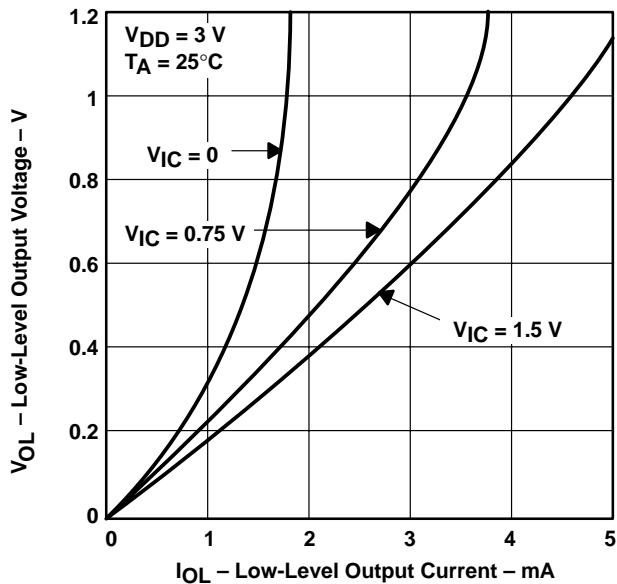

Figure 16

**LOW-LEVEL OUTPUT VOLTAGE†
vs
LOW-LEVEL OUTPUT CURRENT**

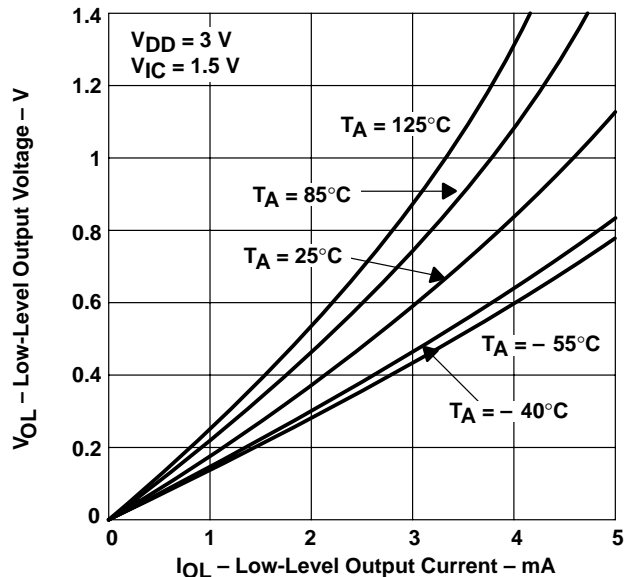

Figure 17

† Data at high and low temperatures are applicable only within the rated operating free-air temperature ranges of the various devices.
‡ For all curves where $V_{DD} = 5\text{ V}$, all loads are referenced to 2.5 V . For all curves where $V_{DD} = 3\text{ V}$, all loads are referenced to 1.5 V .

TYPICAL CHARACTERISTICS

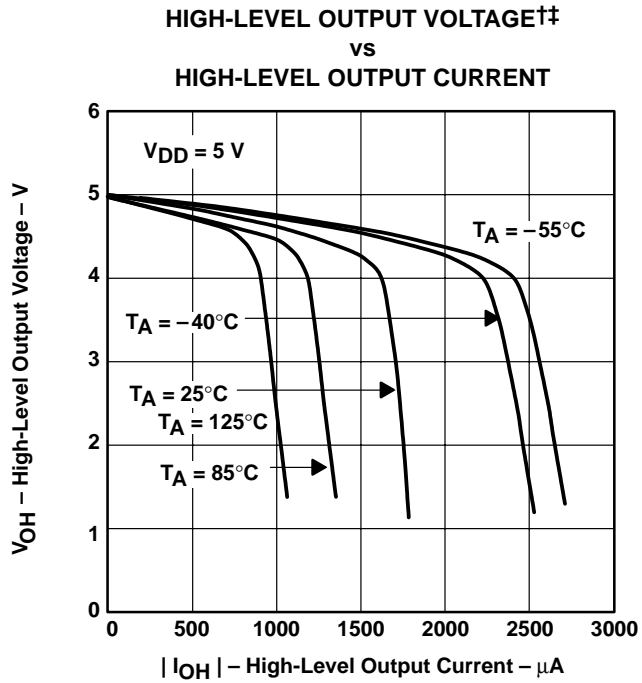

Figure 18

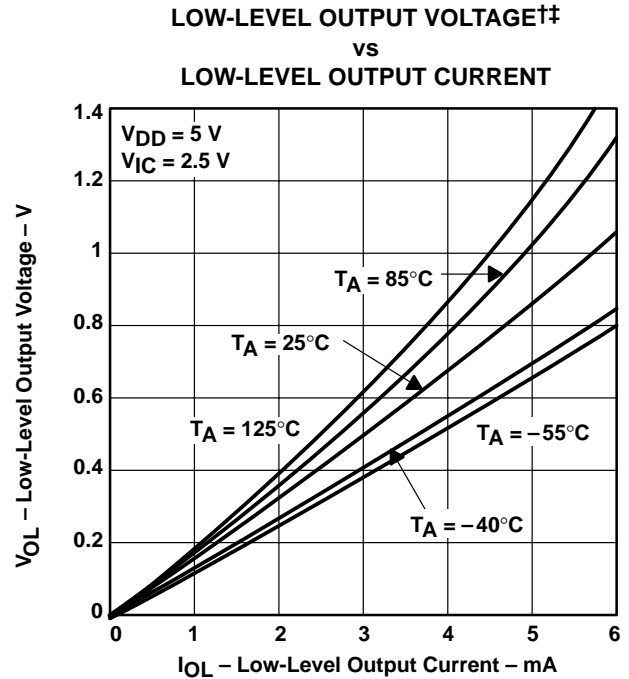

Figure 19

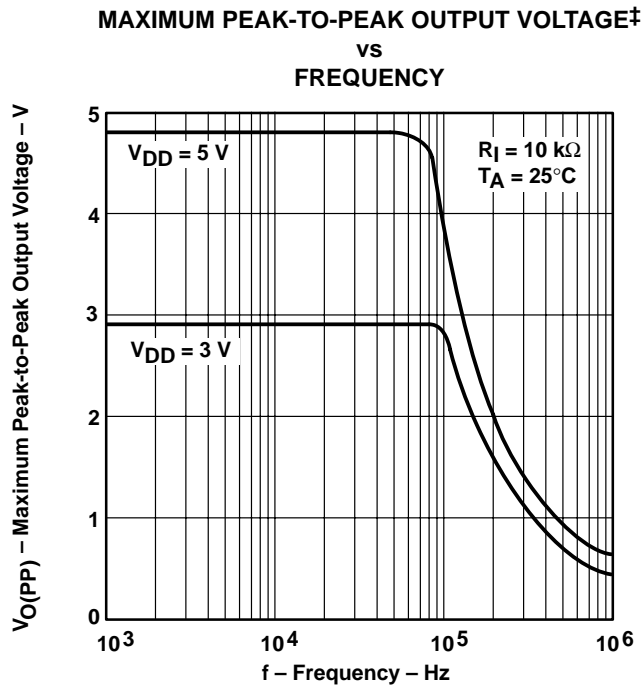

Figure 20

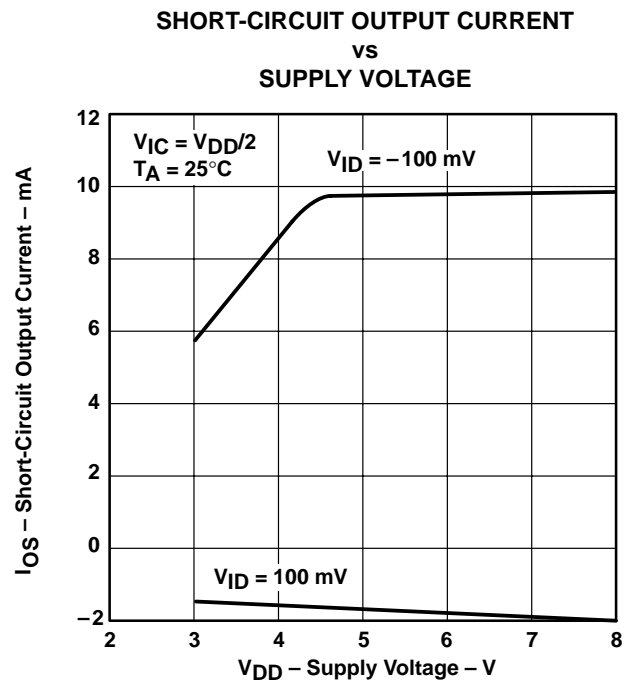

Figure 21

† Data at high and low temperatures are applicable only within the rated operating free-air temperature ranges of the various devices.

‡ For all curves where $V_{DD} = 5\text{ V}$, all loads are referenced to 2.5 V. For all curves where $V_{DD} = 3\text{ V}$, all loads are referenced to 1.5 V.

TYPICAL CHARACTERISTICS

SHORT-CIRCUIT OUTPUT CURRENT†
vs
FREE-AIR TEMPERATURE

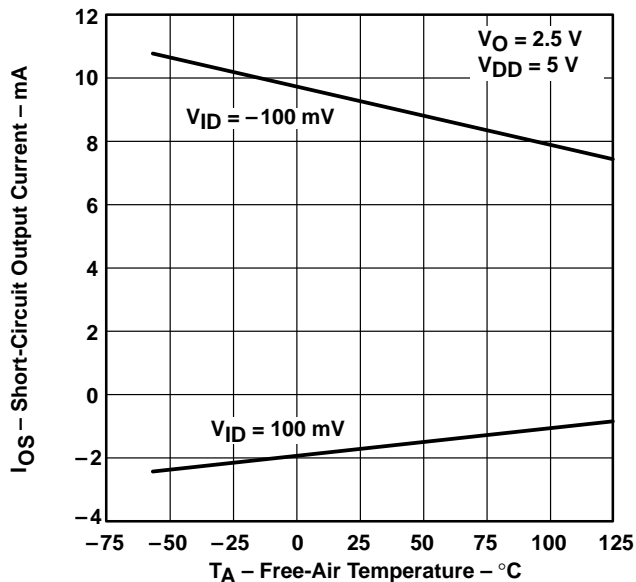

Figure 22

DIFFERENTIAL INPUT VOLTAGE‡
vs
OUTPUT VOLTAGE

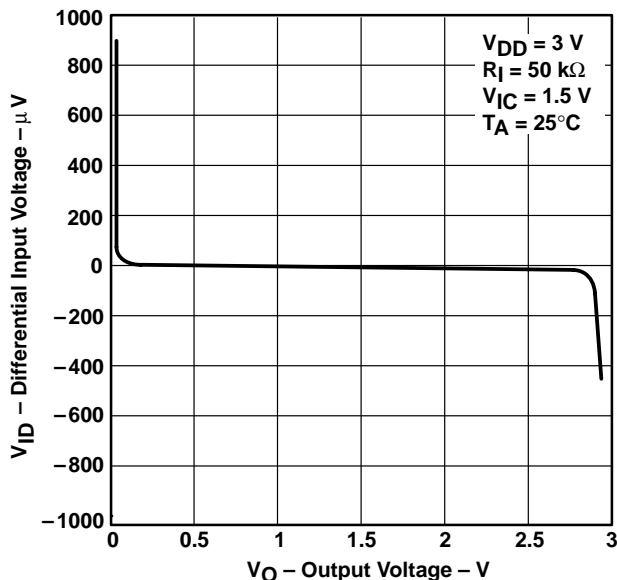

Figure 23

DIFFERENTIAL INPUT VOLTAGE‡
vs
OUTPUT VOLTAGE

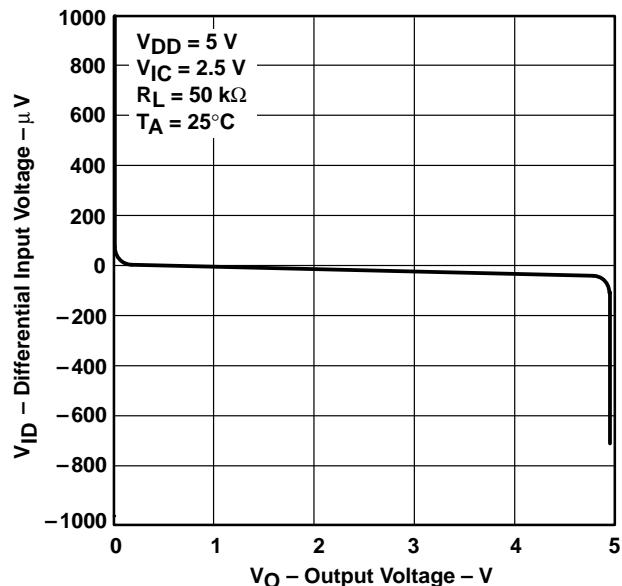

Figure 24

DIFFERENTIAL VOLTAGE AMPLIFICATION‡
vs
LOAD RESISTANCE

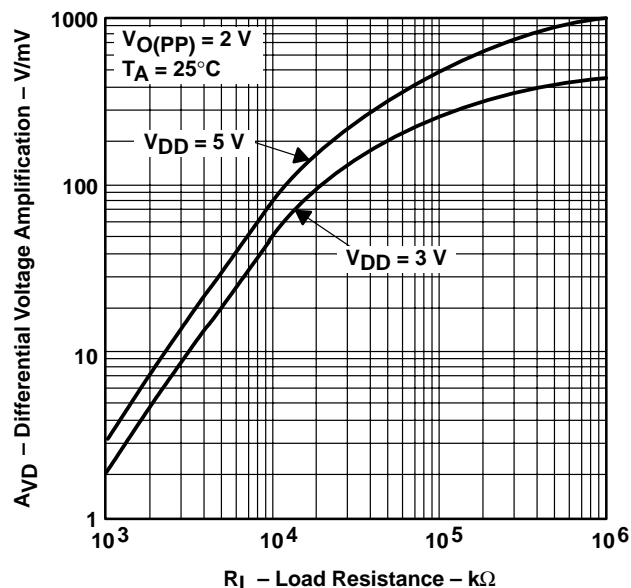

Figure 25

† Data at high and low temperatures are applicable only within the rated operating free-air temperature ranges of the various devices.

‡ For all curves where $V_{DD} = 5\text{ V}$, all loads are referenced to 2.5 V. For all curves where $V_{DD} = 3\text{ V}$, all loads are referenced to 1.5 V.

TYPICAL CHARACTERISTICS

LARGE-SIGNAL DIFFERENTIAL VOLTAGE
 AMPLIFICATION AND PHASE MARGIN†
 vs
 FREQUENCY

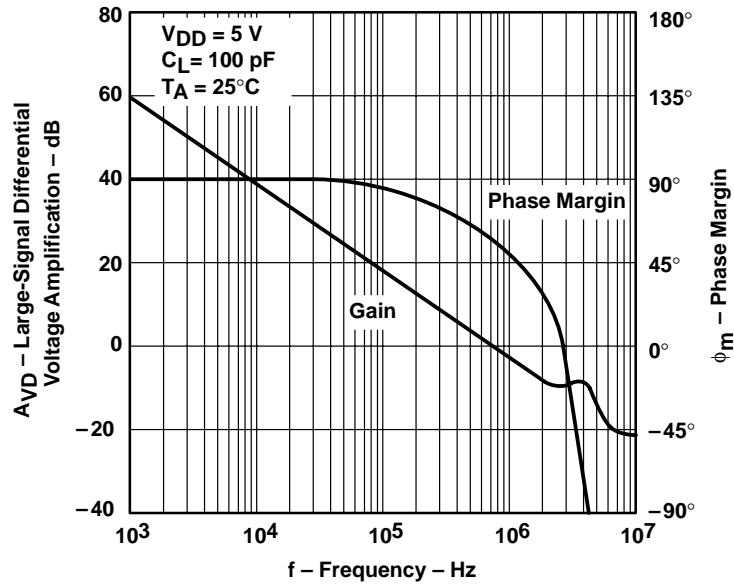

Figure 26

LARGE-SIGNAL DIFFERENTIAL VOLTAGE
 AMPLIFICATION AND PHASE MARGIN†
 vs
 FREQUENCY

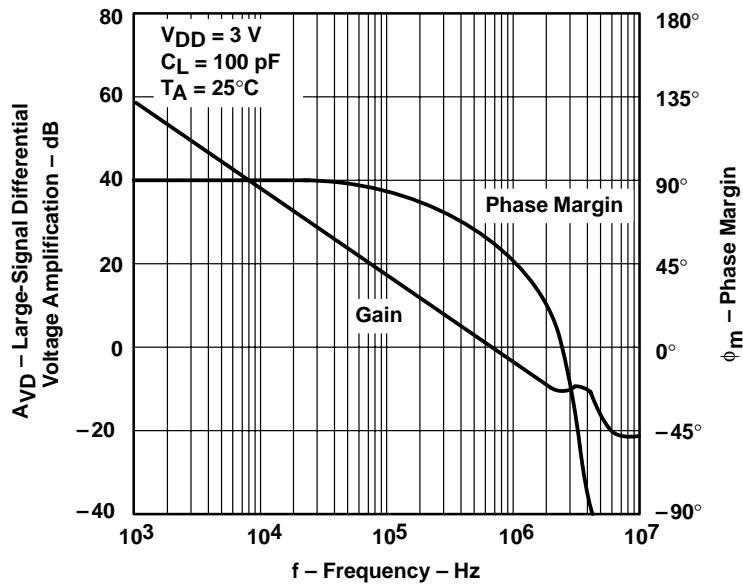

Figure 27

† For all curves where $V_{DD} = 5\text{ V}$, all loads are referenced to 2.5 V. For all curves where $V_{DD} = 3\text{ V}$, all loads are referenced to 1.5 V.

TYPICAL CHARACTERISTICS

LARGE-SIGNAL DIFFERENTIAL
 VOLTAGE AMPLIFICATION†‡
 vs
 FREE-AIR TEMPERATURE

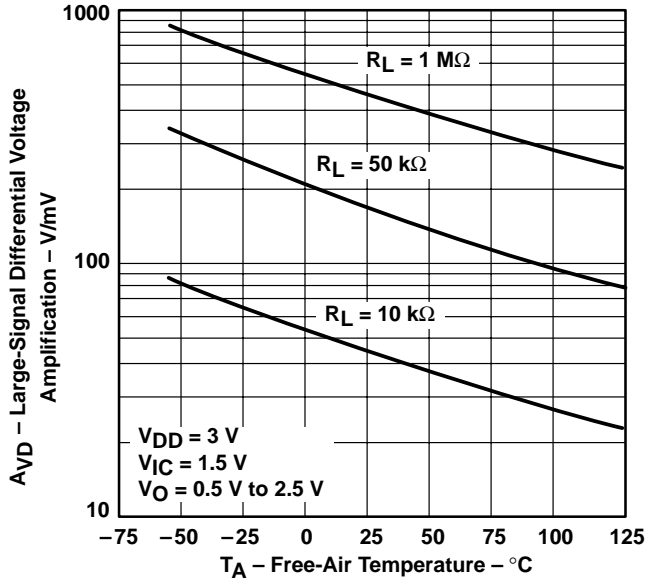

Figure 28

LARGE-SIGNAL DIFFERENTIAL
 VOLTAGE AMPLIFICATION†‡
 vs
 FREE-AIR TEMPERATURE

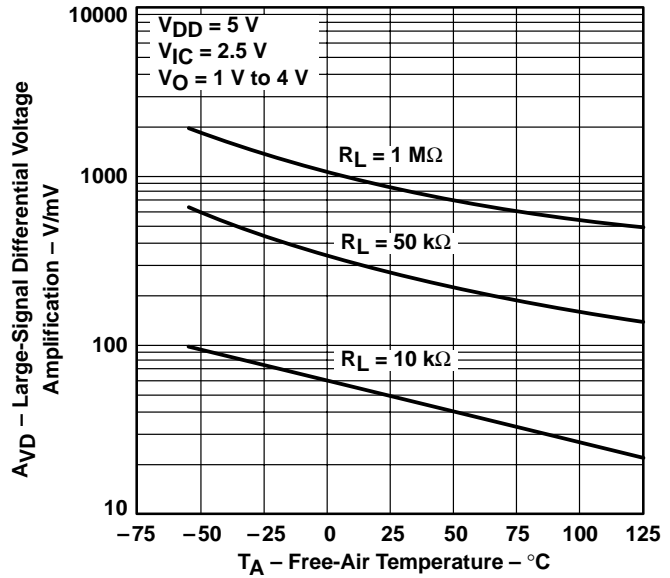

Figure 29

OUTPUT IMPEDANCE‡
 vs
 FREQUENCY

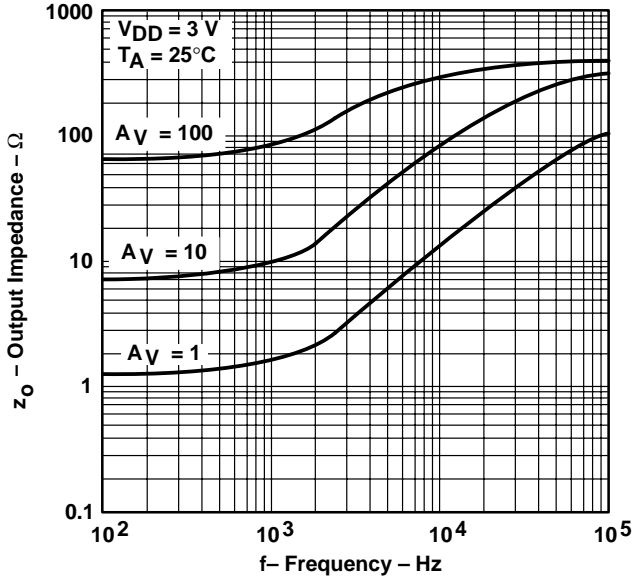

Figure 30

OUTPUT IMPEDANCE‡
 vs
 FREQUENCY

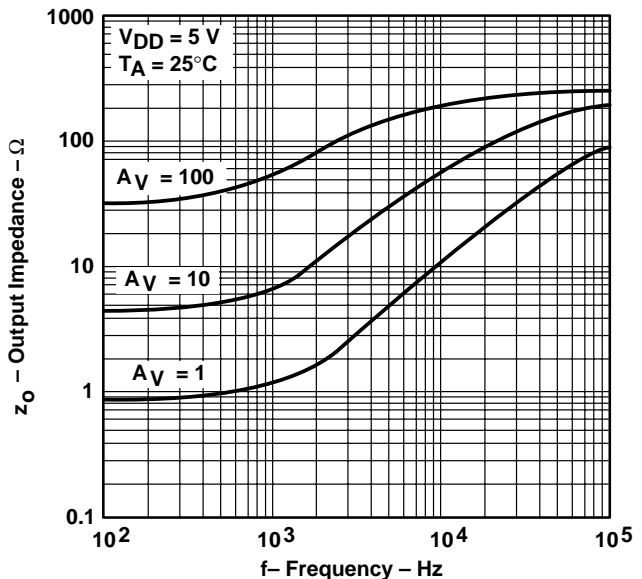

Figure 31

† Data at high and low temperatures are applicable only within the rated operating free-air temperature ranges of the various devices.

‡ For all curves where VDD = 5 V, all loads are referenced to 2.5 V. For all curves where VDD = 3 V, all loads are referenced to 1.5 V.

TYPICAL CHARACTERISTICS

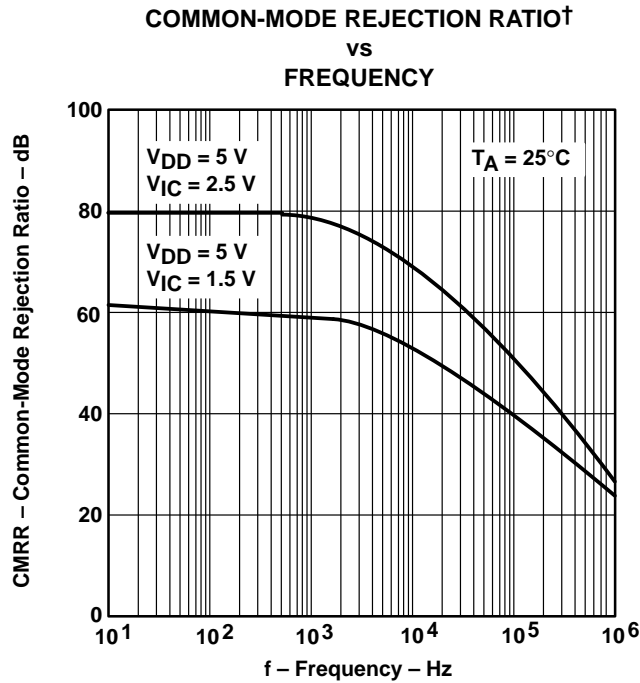

Figure 32

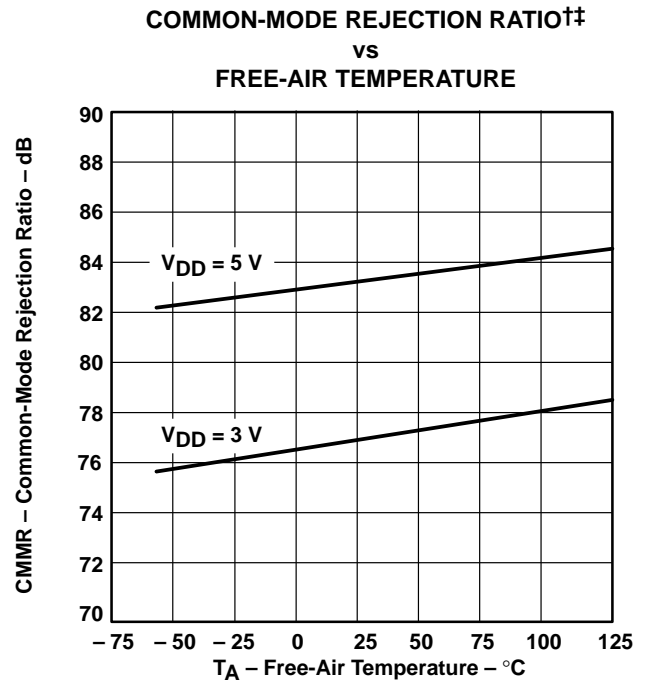

Figure 33

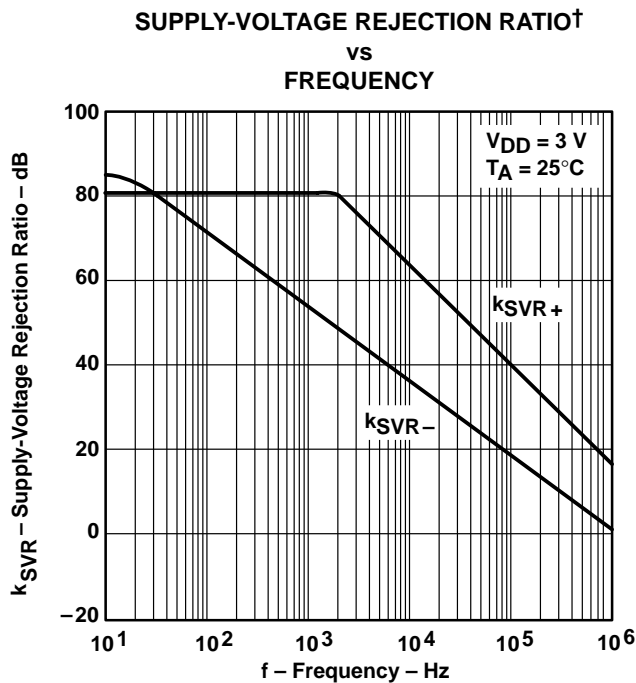

Figure 34

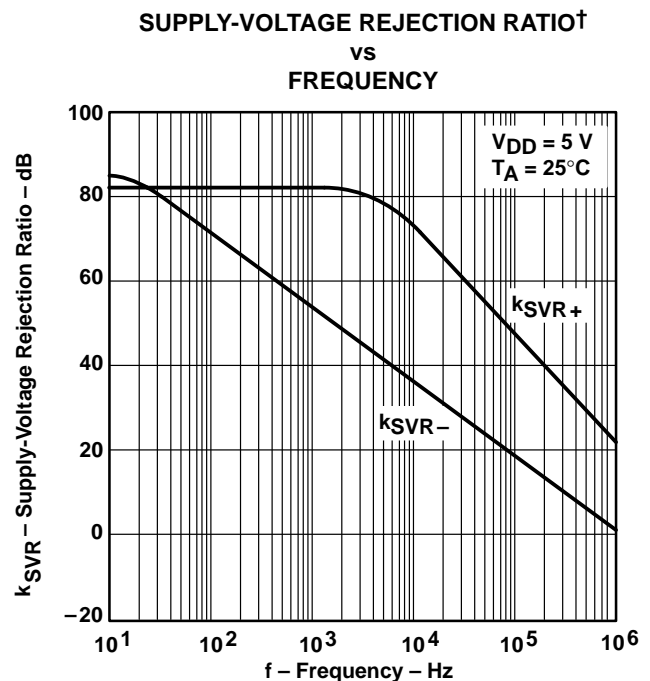

Figure 35

† For all curves where $V_{DD} = 5\text{ V}$, all loads are referenced to 2.5 V. For all curves where $V_{DD} = 3\text{ V}$, all loads are referenced to 1.5 V.
‡ Data at high and low temperatures are applicable only within the rated operating free-air temperature ranges of the various devices.

TYPICAL CHARACTERISTICS

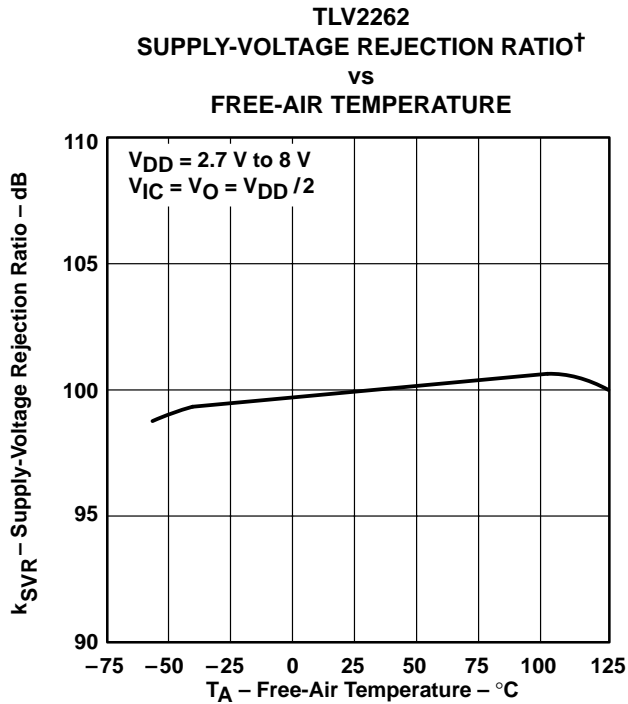

Figure 36

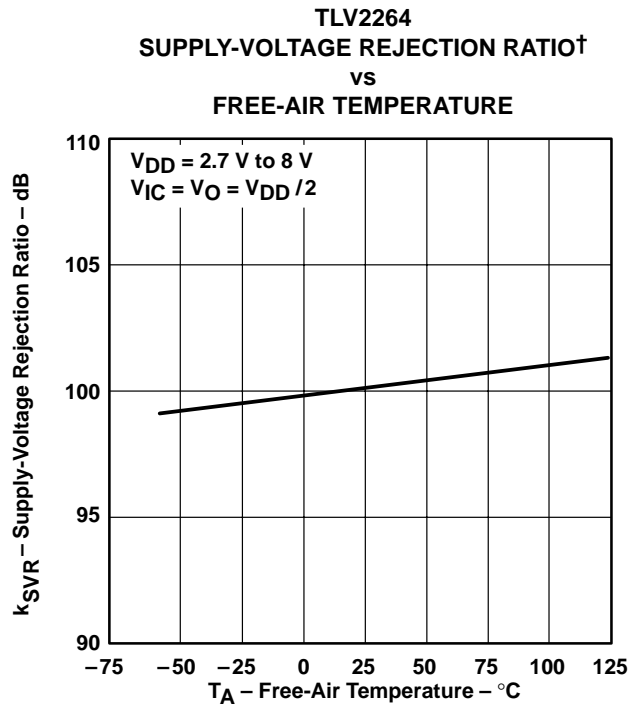

Figure 37

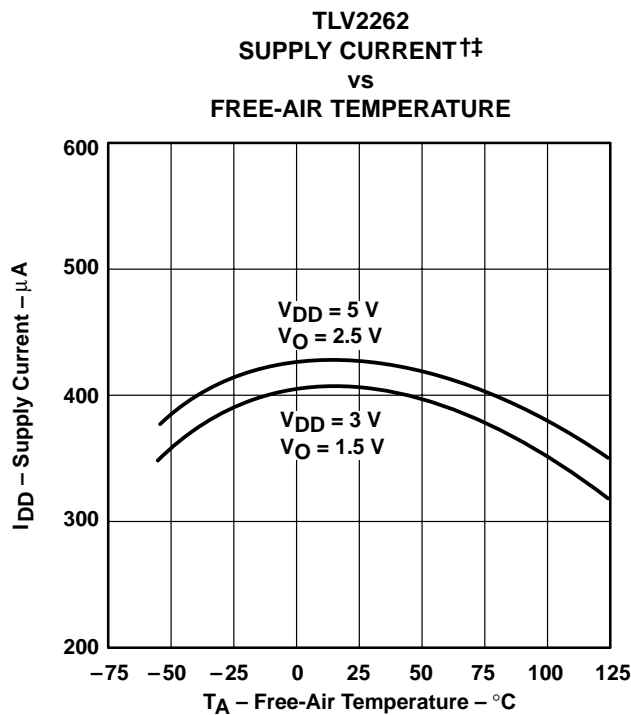

Figure 38

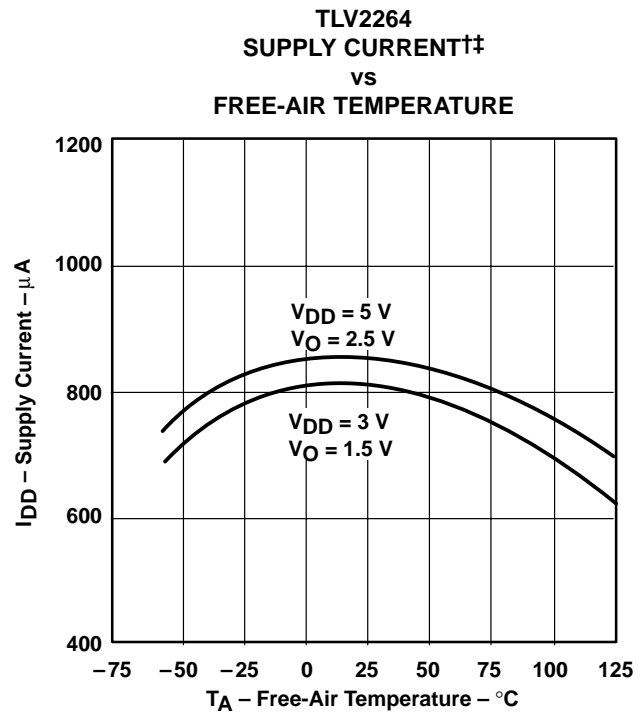
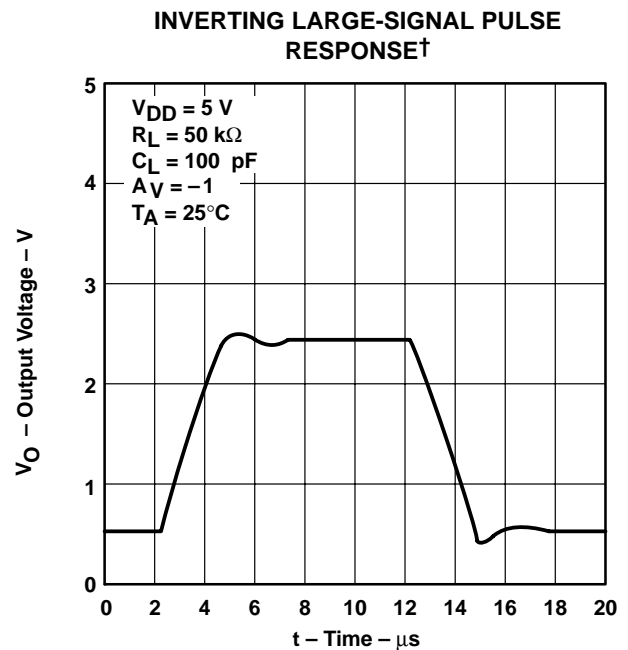
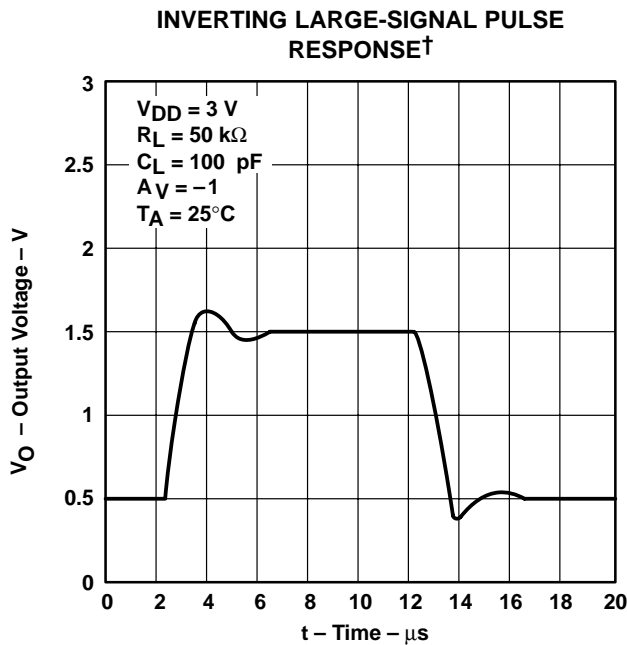
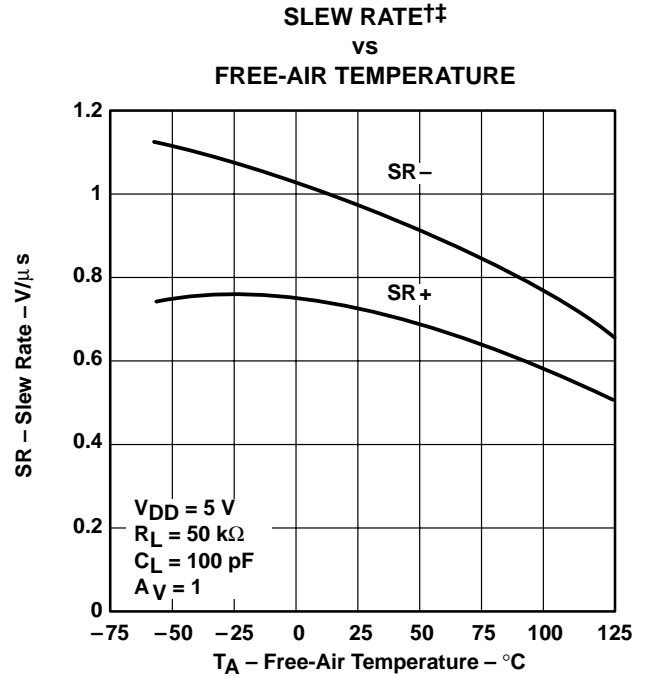
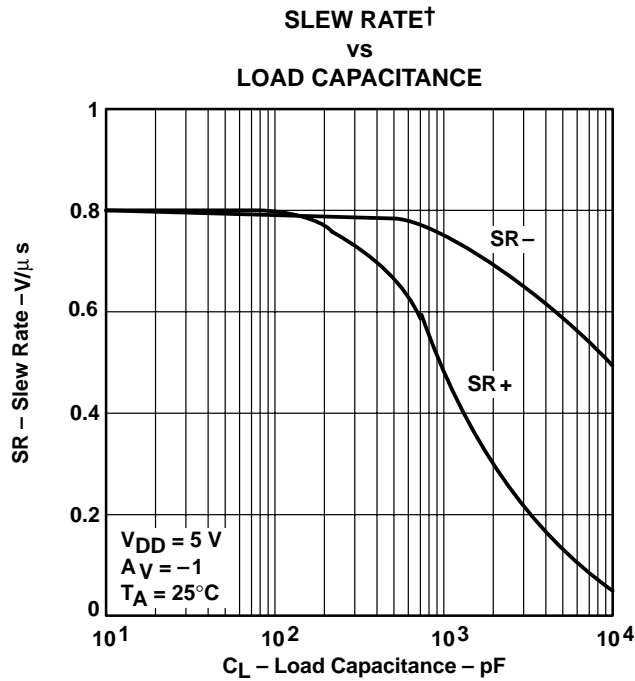

Figure 39

† Data at high and low temperatures are applicable only within the rated operating free-air temperature ranges of the various devices.

‡ For all curves where $V_{DD} = 5 \text{ V}$, all loads are referenced to 2.5 V. For all curves where $V_{DD} = 3 \text{ V}$, all loads are referenced to 1.5 V.

TYPICAL CHARACTERISTICS



† For all curves where $V_{DD} = 5\text{ V}$, all loads are referenced to 2.5 V. For all curves where $V_{DD} = 3\text{ V}$, all loads are referenced to 1.5 V.
 ‡ Data at high and low temperatures are applicable only within the rated operating free-air temperature ranges of the various devices.

TYPICAL CHARACTERISTICS

VOLTAGE-FOLLOWER LARGE-SIGNAL PULSE RESPONSE†

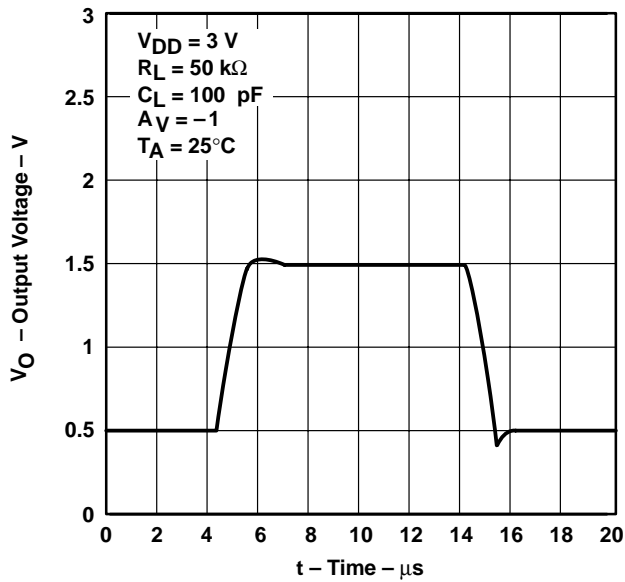

Figure 44

VOLTAGE-FOLLOWER LARGE-SIGNAL PULSE RESPONSE†

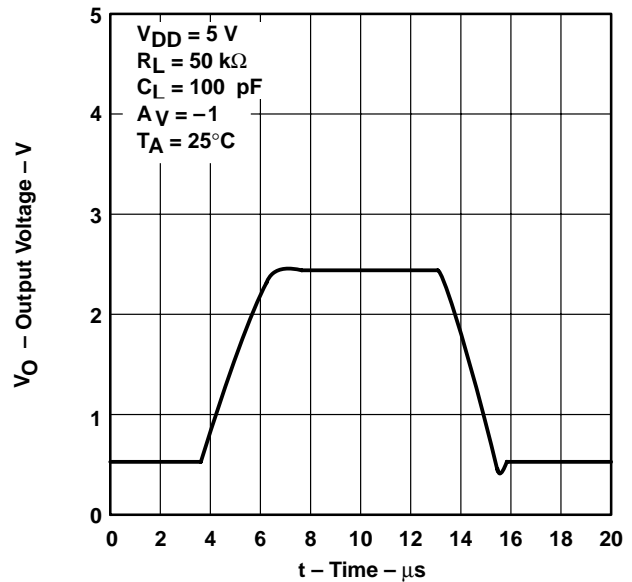

Figure 45

INVERTING SMALL-SIGNAL PULSE RESPONSE†

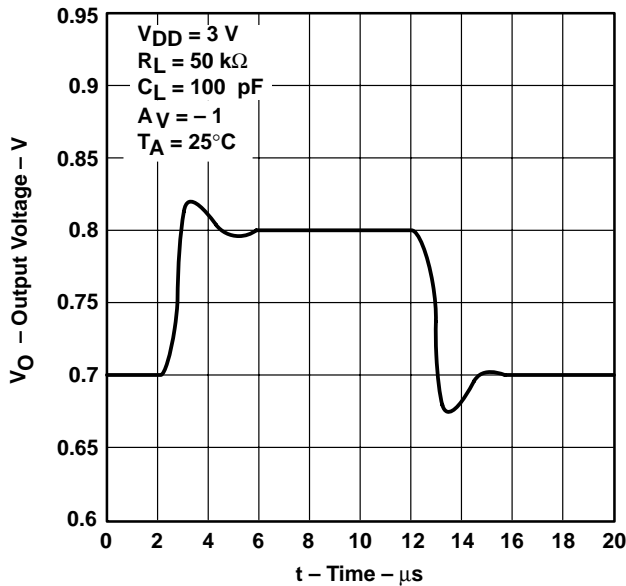

Figure 46

INVERTING SMALL-SIGNAL PULSE RESPONSE†

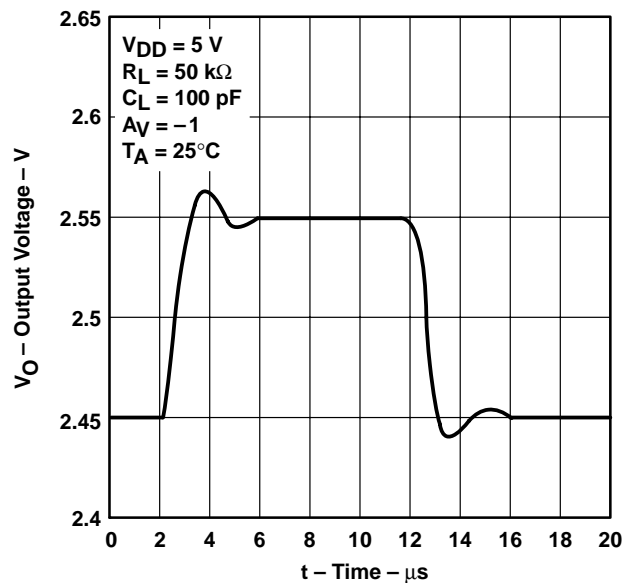

Figure 47

† For all curves where $V_{DD} = 5\text{ V}$, all loads are referenced to 2.5 V. For all curves where $V_{DD} = 3\text{ V}$, all loads are referenced to 1.5 V.

TYPICAL CHARACTERISTICS

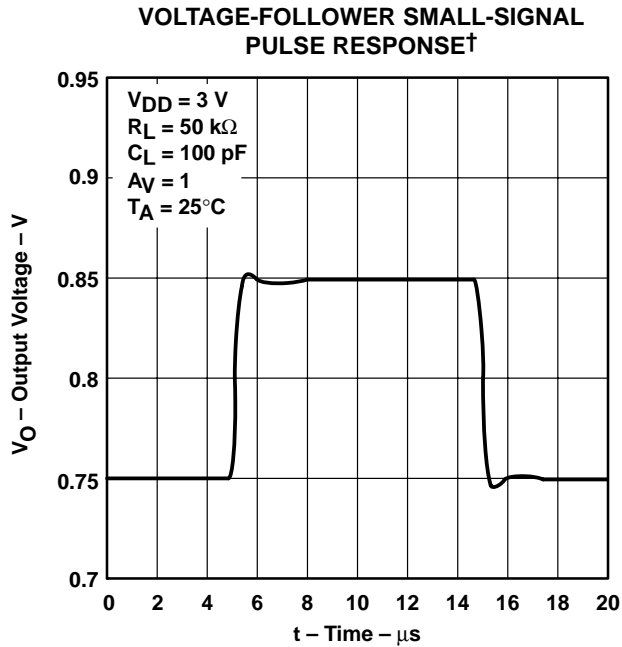

Figure 48

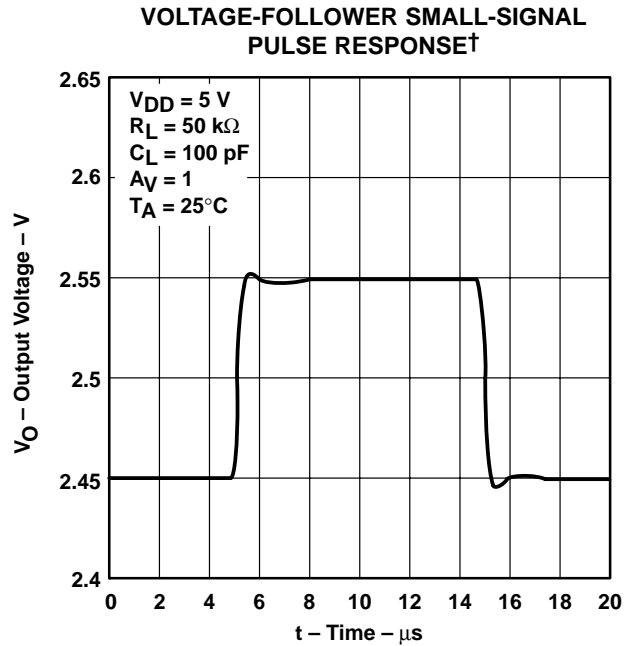

Figure 49

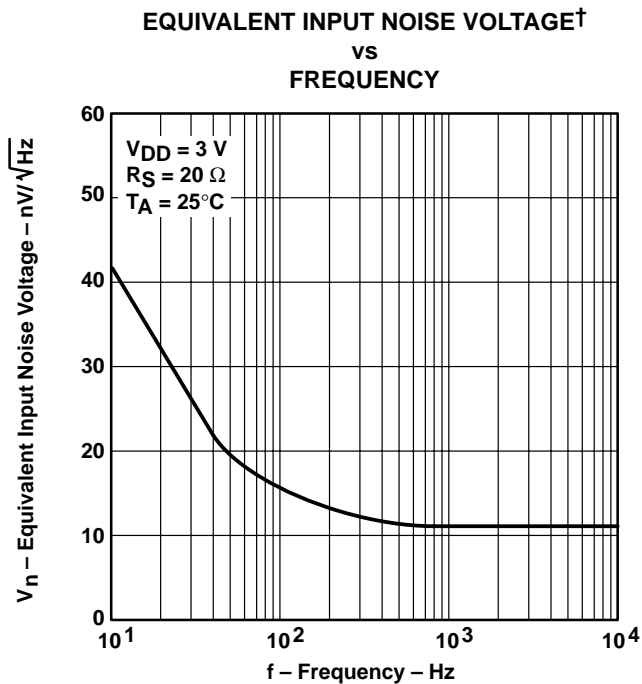

Figure 50

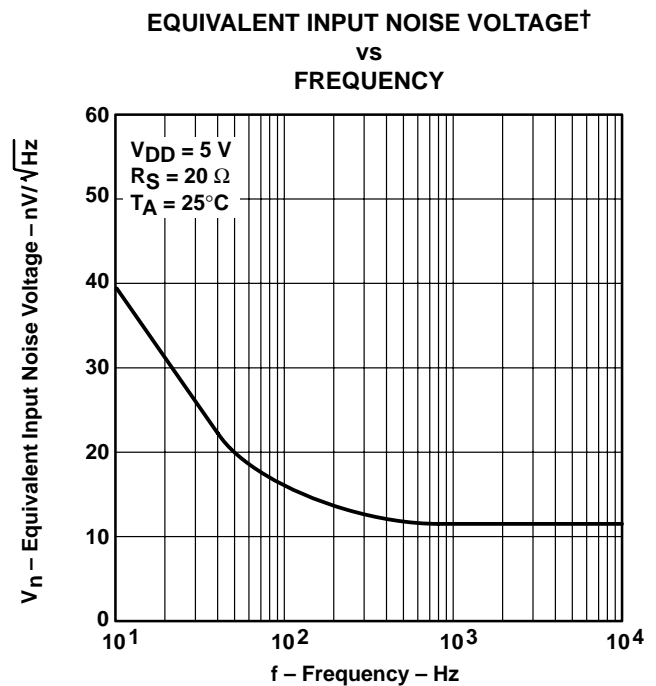

Figure 51

† For all curves where $V_{DD} = 5\text{ V}$, all loads are referenced to 2.5 V. For all curves where $V_{DD} = 3\text{ V}$, all loads are referenced to 1.5 V.

TYPICAL CHARACTERISTICS

**INPUT NOISE VOLTAGE OVER
A 10-SECOND PERIOD†**

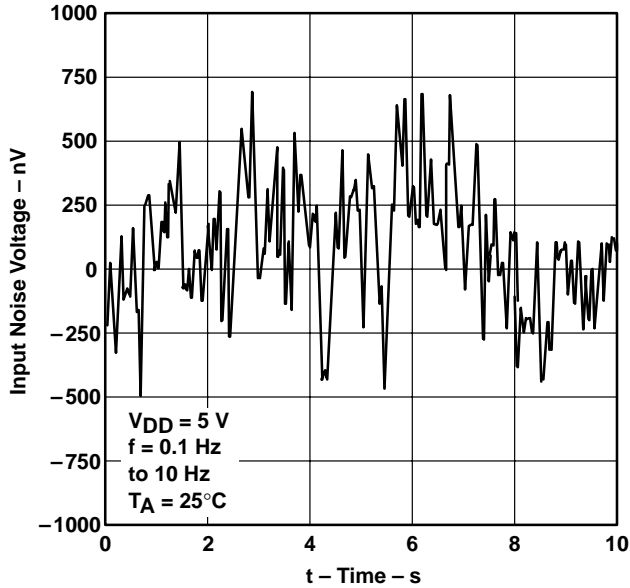

Figure 52

**INTEGRATED NOISE VOLTAGE
VS
FREQUENCY**

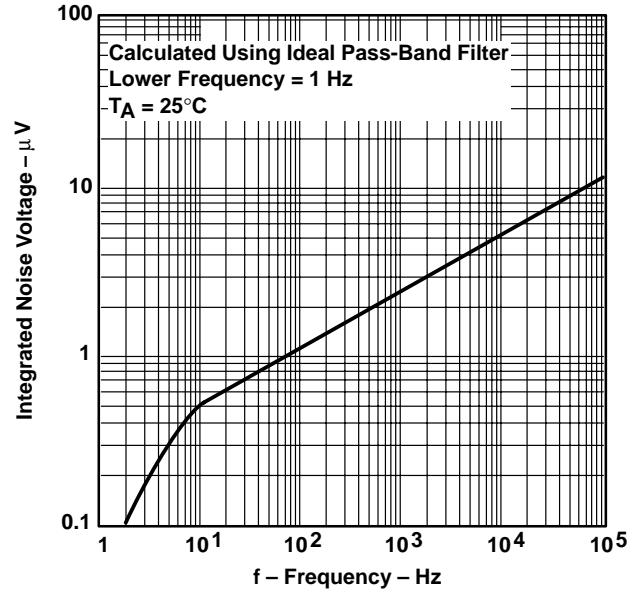

Figure 53

**TOTAL HARMONIC DISTORTION PLUS NOISE†
VS
FREQUENCY**

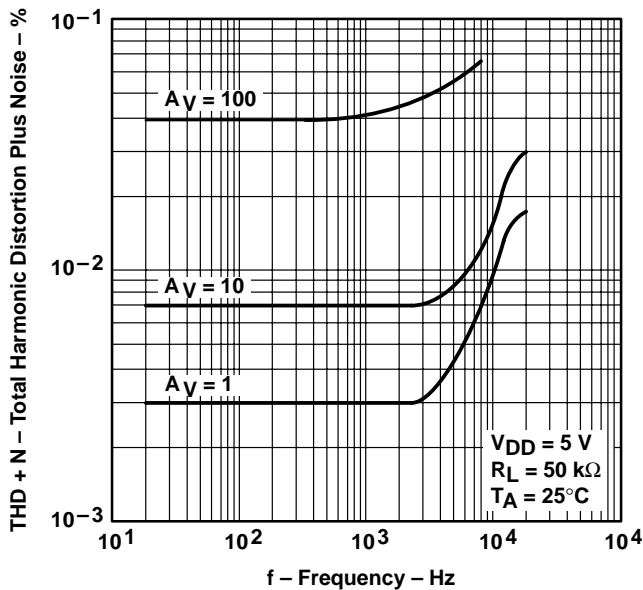

Figure 54

**GAIN-BANDWIDTH PRODUCT
VS
SUPPLY VOLTAGE**

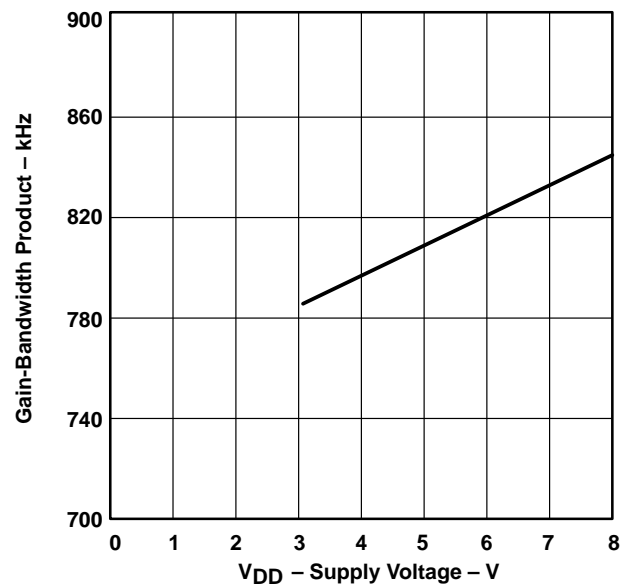

Figure 55

† For all curves where $V_{DD} = 5\text{ V}$, all loads are referenced to 2.5 V. For all curves where $V_{DD} = 3\text{ V}$, all loads are referenced to 1.5 V.

TYPICAL CHARACTERISTICS

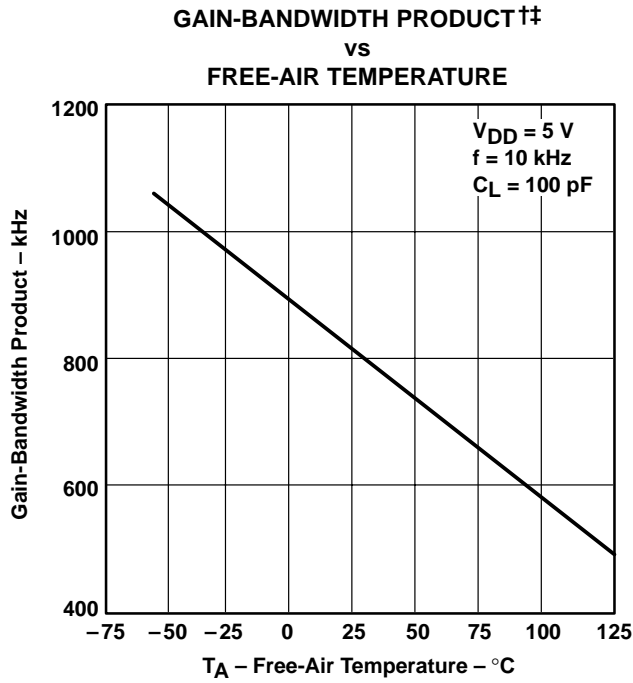

Figure 56

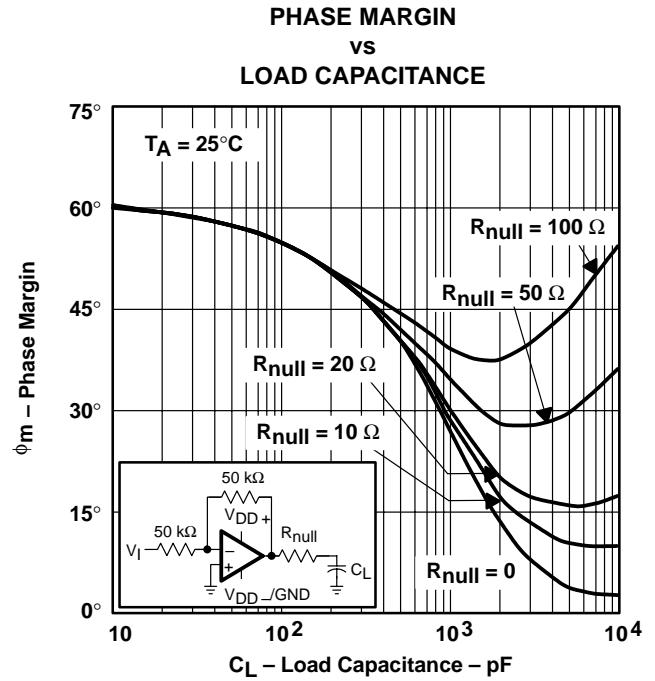

Figure 57

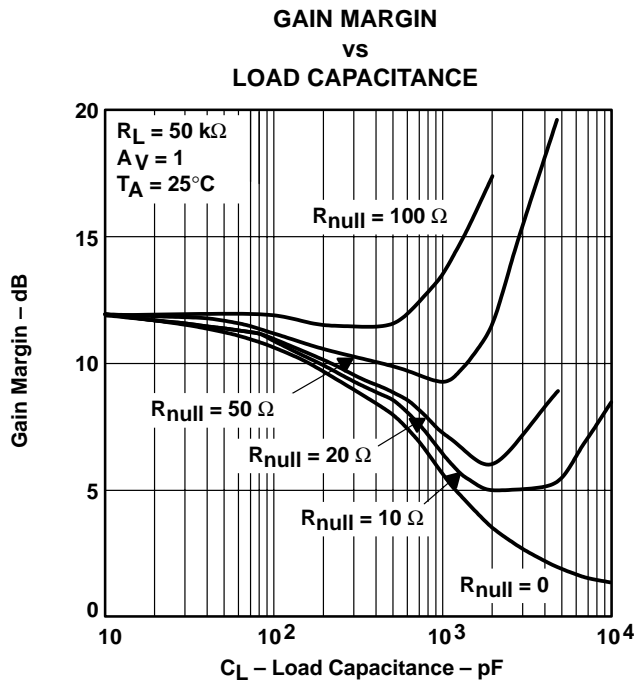

Figure 58

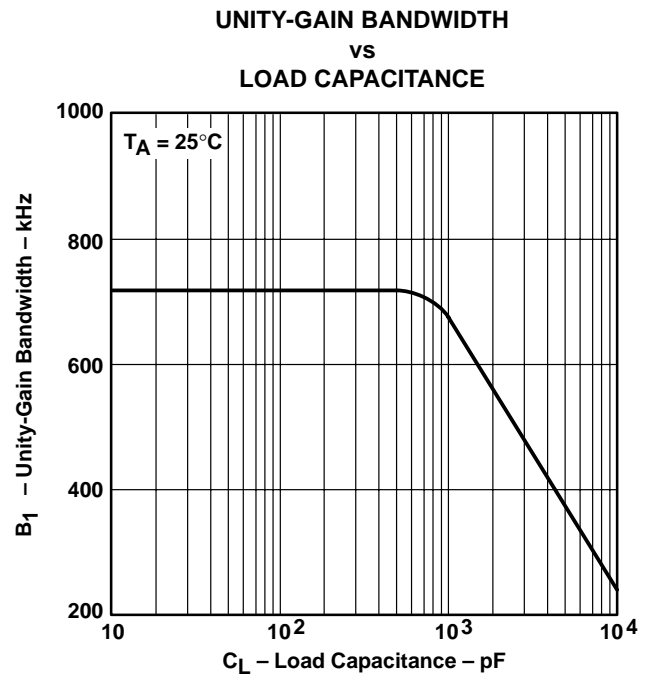
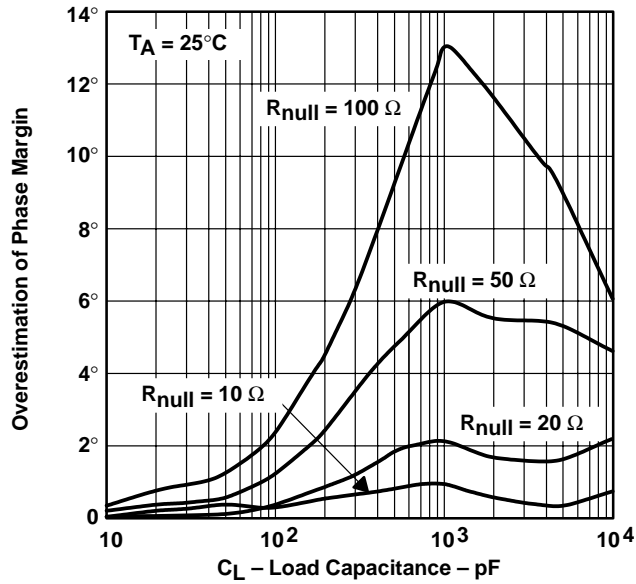

Figure 59

† For all curves where $V_{DD} = 5\text{ V}$, all loads are referenced to 2.5 V. For all curves where $V_{DD} = 3\text{ V}$, all loads are referenced to 1.5 V.
†† Data at high and low temperatures are applicable only within the rated operating free-air temperature ranges of the various devices.

TYPICAL CHARACTERISTICS

OVERESTIMATION OF PHASE MARGIN†
 vs
 LOAD CAPACITANCE



† See application information

Figure 60

APPLICATION INFORMATION

driving large capacitive loads

The TLV226x is designed to drive larger capacitive loads than most CMOS operational amplifiers. Figure 51 and Figure 52 illustrate its ability to drive loads greater than 400 pF while maintaining good gain and phase margins ($R_{null} = 0$).

A smaller series resistor (R_{null}) at the output of the device (see Figure 61) improves the gain and phase margins when driving large capacitive loads. Figure 51 and Figure 52 show the effects of adding series resistances of 10 Ω , 20 Ω , 50 Ω , and 100 Ω . The addition of this series resistor has two effects: the first is that it adds a zero to the transfer function and the second is that it reduces the frequency of the pole associated with the output load in the transfer function.

The zero introduced to the transfer function is equal to the series resistance times the load capacitance. To calculate the improvement in phase margin, equation (1) can be used.

$$\Delta\theta_{m1} = \tan^{-1} \left(2 \times \pi \times \text{UGBW} \times R_{null} \times C_L \right) \quad (1)$$

Where :

- $\Delta\theta_{m1}$ = improvement in phase margin
- UGBW = unity-gain bandwidth frequency
- R_{null} = output series resistance
- C_L = load capacitance

The unity-gain bandwidth (UGBW) frequency decreases as the capacitive load increases (see Figure 53). To use equation 1, UGBW must be approximated from Figure 53.

Using equation 1 alone overestimates the improvement in phase margin as illustrated in Figure 59. The overestimation is caused by the decrease in the frequency of the pole associated with the load, providing additional phase shift and reducing the overall improvement in phase margin. The pole associated with the load is reduced by the factor calculated in equation 2.

$$F = \frac{1}{1 + g_m \times R_{null}} \quad (2)$$

Where :

- F = factor reducing frequency of pole
- g_m = small-signal output transconductance (typically 4.83×10^{-3} mhos)
- R_{null} = output series resistance

For the TLV226x, the pole associated with the load is typically 7 MHz with 100-pF load capacitance. This value varies inversely with C_L : at $C_L = 10$ pF, use 70 MHz, at $C_L = 1000$ pF, use 700 kHz, and so on.

Reducing the pole associated with the load introduces phase shift, thereby reducing phase margin. This results in an error in the increase in phase margin expected by considering the zero alone (equation 1). Equation 3 approximates the reduction in phase margin due to the movement of the pole associated with the load. The result of this equation can be subtracted from the result of the equation 1 to better approximate the improvement in phase margin.

APPLICATION INFORMATION

driving large capacitive loads (continued)

$$\Delta\theta_{m2} = \tan^{-1} \left[\frac{UGBW}{(F \times P_2)} \right] - \tan^{-1} \left(\frac{UGBW}{P_2} \right) \tag{3}$$

Where :

$\Delta\theta_{m2}$ = reduction in phase margin

UGBW = unity-gain bandwidth frequency

F = factor from equation (2)

P_2 = unadjusted pole (70 MHz @ 10 pF, 7 MHz @ 100 pF, etc.)

Using these equations with Figure 60 and Figure 61 enables the designer to choose the appropriate output series resistance to optimize the design of circuits driving large capacitive loads.

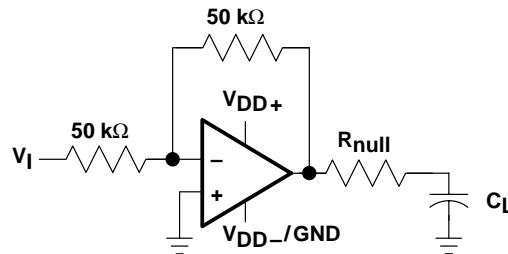

Figure 61. Series-Resistance Circuit

APPLICATION INFORMATION

macromodel information

Macromodel information provided was derived using Microsim *Parts*™, the model generation software used with Microsim *PSpice*™. The Boyle macromodel (see Note 5) and subcircuit in Figure 62 are generated using the TLV226x typical electrical and operating characteristics at $T_A = 25^\circ\text{C}$. Using this information, output simulations of the following key parameters can be generated to a tolerance of 20% (in most cases):

- Maximum positive output voltage swing
- Maximum negative output voltage swing
- Slew rate
- Quiescent power dissipation
- Input bias current
- Open-loop voltage amplification
- Unity-gain frequency
- Common-mode rejection ratio
- Phase margin
- DC output resistance
- AC output resistance
- Short-circuit output current limit

NOTE 5: G. R. Boyle, B. M. Cohn, D. O. Pederson, and J. E. Solomon, "Macromodeling of Integrated Circuit Operational Amplifiers," *IEEE Journal of Solid-State Circuits*, SC-9, 353 (1974).

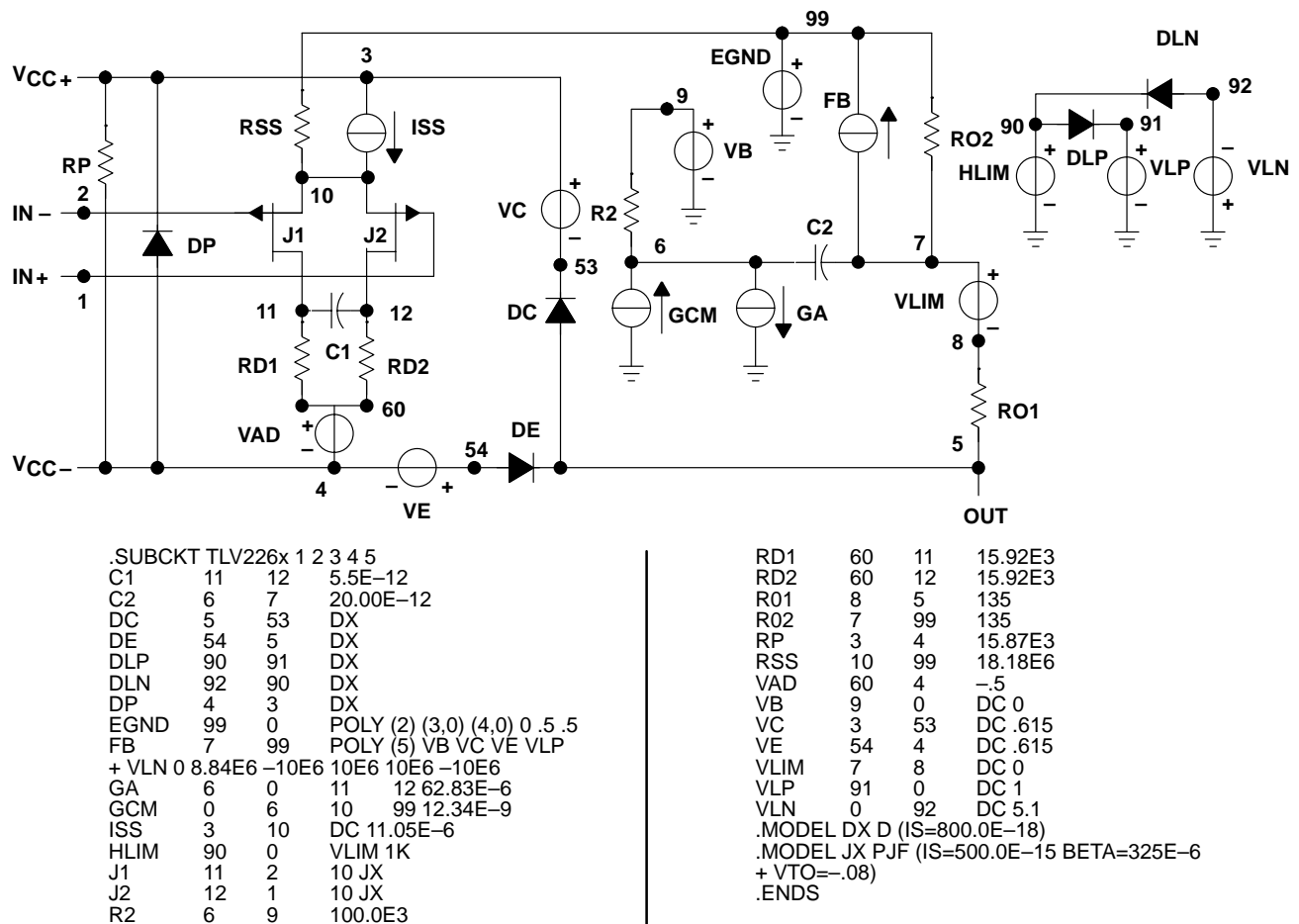

Figure 62. Boyle Macromodel and Subcircuit

PSpice and *Parts* are trademarks of MicroSim Corporation.

TLV226x, TLV226xA
Advanced LinCMOS™ RAIL-TO-RAIL
OPERATIONAL AMPLIFIERS

SLOS186B – FEBRUARY 1997 – REVISED MARCH 2001

MECHANICAL INFORMATION

D (R-PDSO-G)**

PLASTIC SMALL-OUTLINE PACKAGE

14 PIN SHOWN

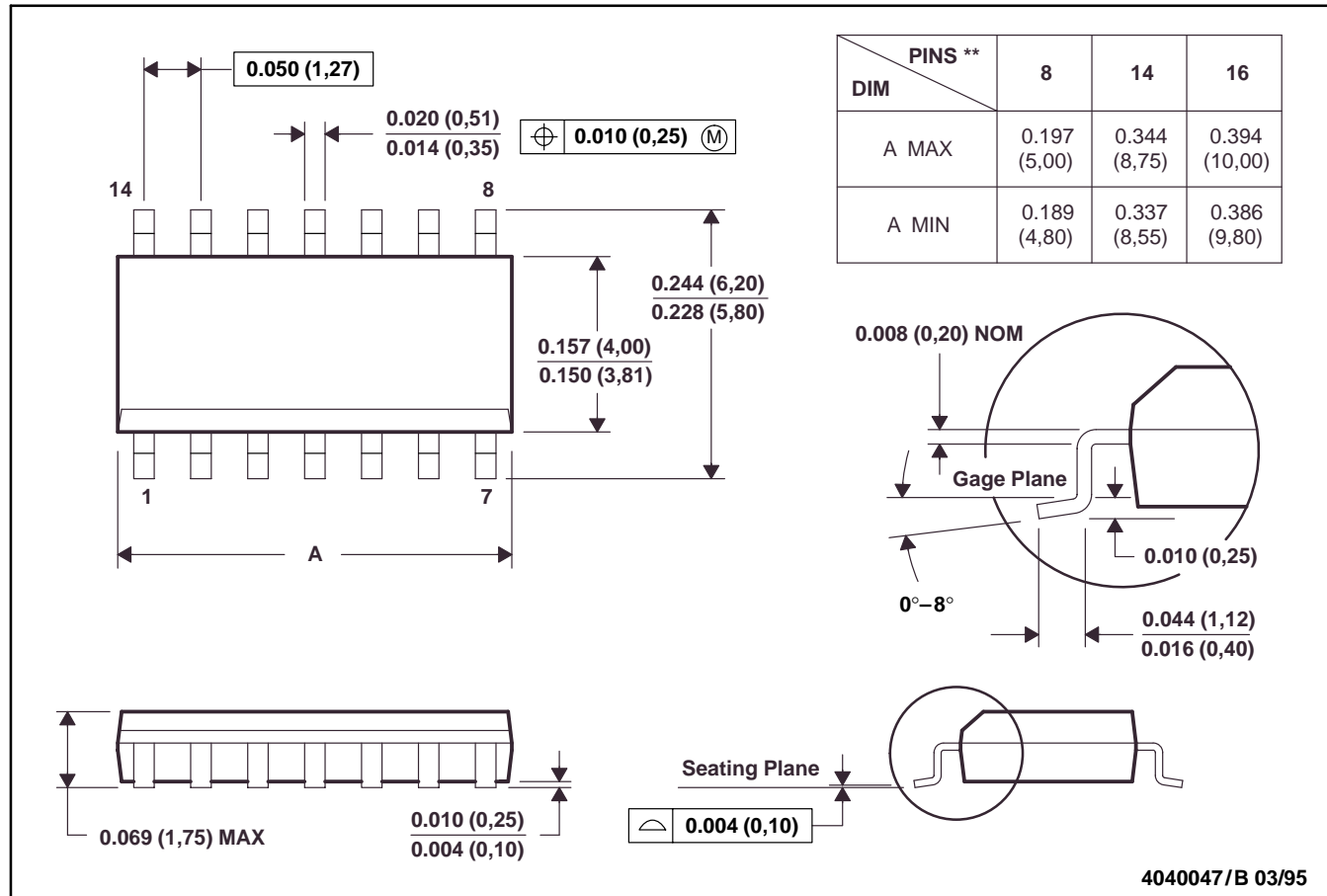

- NOTES: A. All linear dimensions are in inches (millimeters).
 B. This drawing is subject to change without notice.
 C. Body dimensions do not include mold flash or protrusion, not to exceed 0.006 (0,15).
 D. Four center pins are connected to die mount pad.
 E. Falls within JEDEC MS-012

MECHANICAL INFORMATION

FK (S-CQCC-N**)

LEADLESS CERAMIC CHIP CARRIER

28 TERMINAL SHOWN

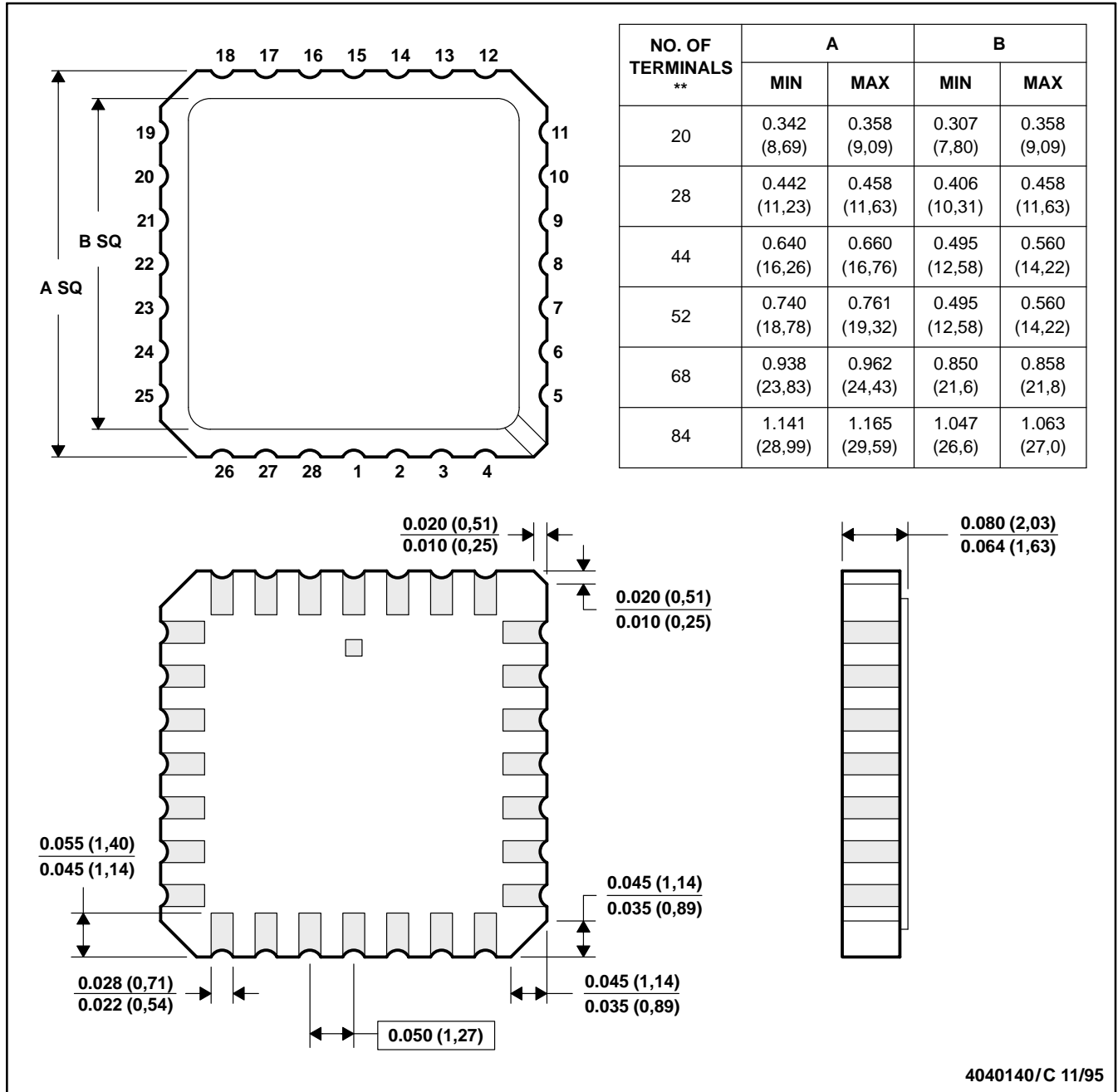

- NOTES: A. All linear dimensions are in inches (millimeters).
 B. This drawing is subject to change without notice.
 C. This package can be hermetically sealed with a metal lid.
 D. The terminals are gold plated.
 E. Falls within JEDEC MS-004

TLV226x, TLV226xA
Advanced LinCMOS™ RAIL-TO-RAIL
OPERATIONAL AMPLIFIERS

SLOS186B – FEBRUARY 1997 – REVISED MARCH 2001

MECHANICAL INFORMATION

J (R-GDIP-T)**

CERAMIC DUAL-IN-LINE PACKAGE

14 PIN SHOWN

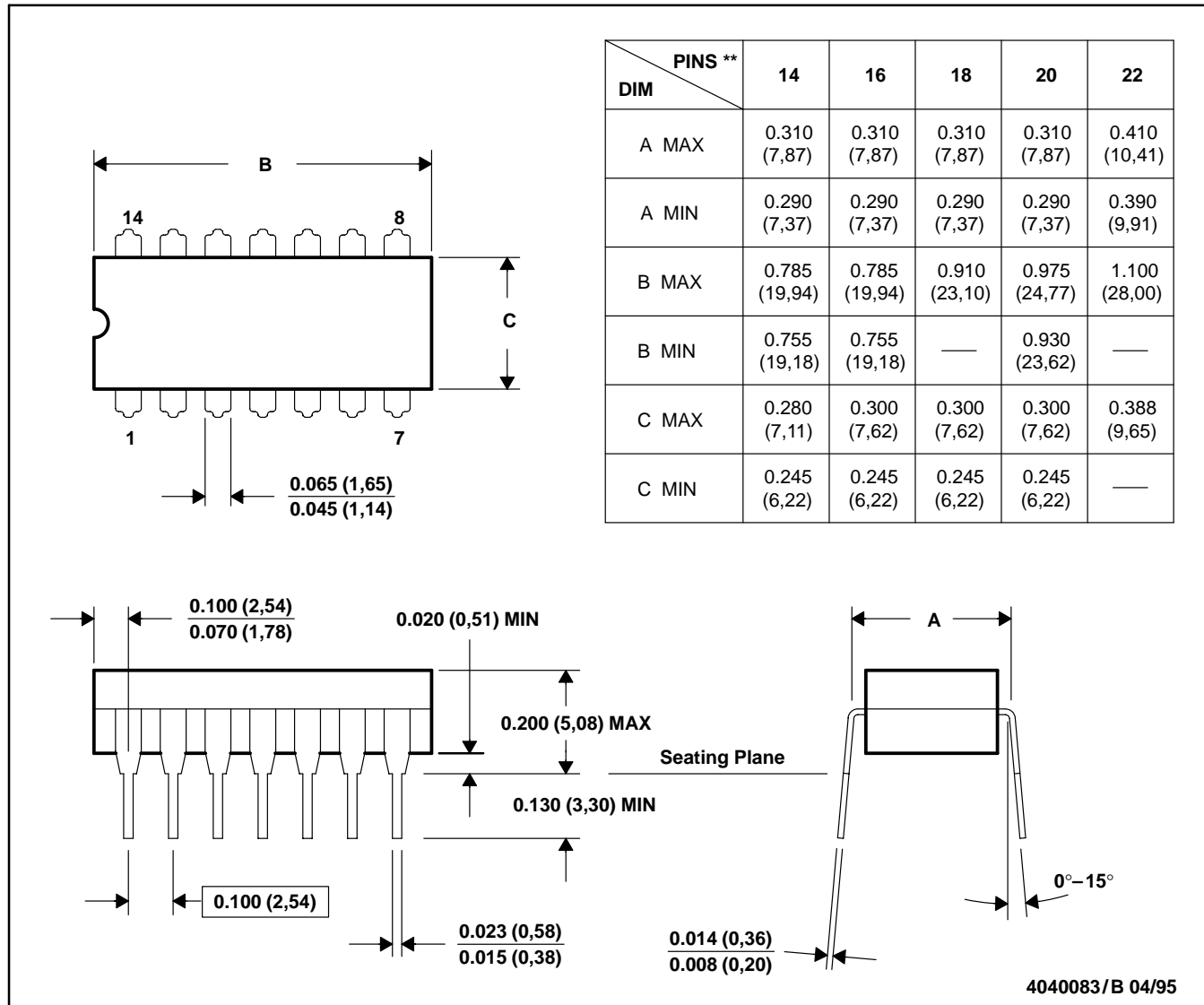

- NOTES: A. All linear dimensions are in inches (millimeters).
 B. This drawing is subject to change without notice.
 C. This package can be hermetically sealed with a ceramic lid using glass frit.
 D. Index point is provided on cap for terminal identification only on press ceramic glass frit seal only.
 E. Falls within MIL-STD-1835 GDIP1-T14, GDIP1-T16, GDIP1-T18, GDIP1-T20, and GDIP1-T22

MECHANICAL INFORMATION

JG (R-GDIP-T8)

CERAMIC DUAL-IN-LINE PACKAGE

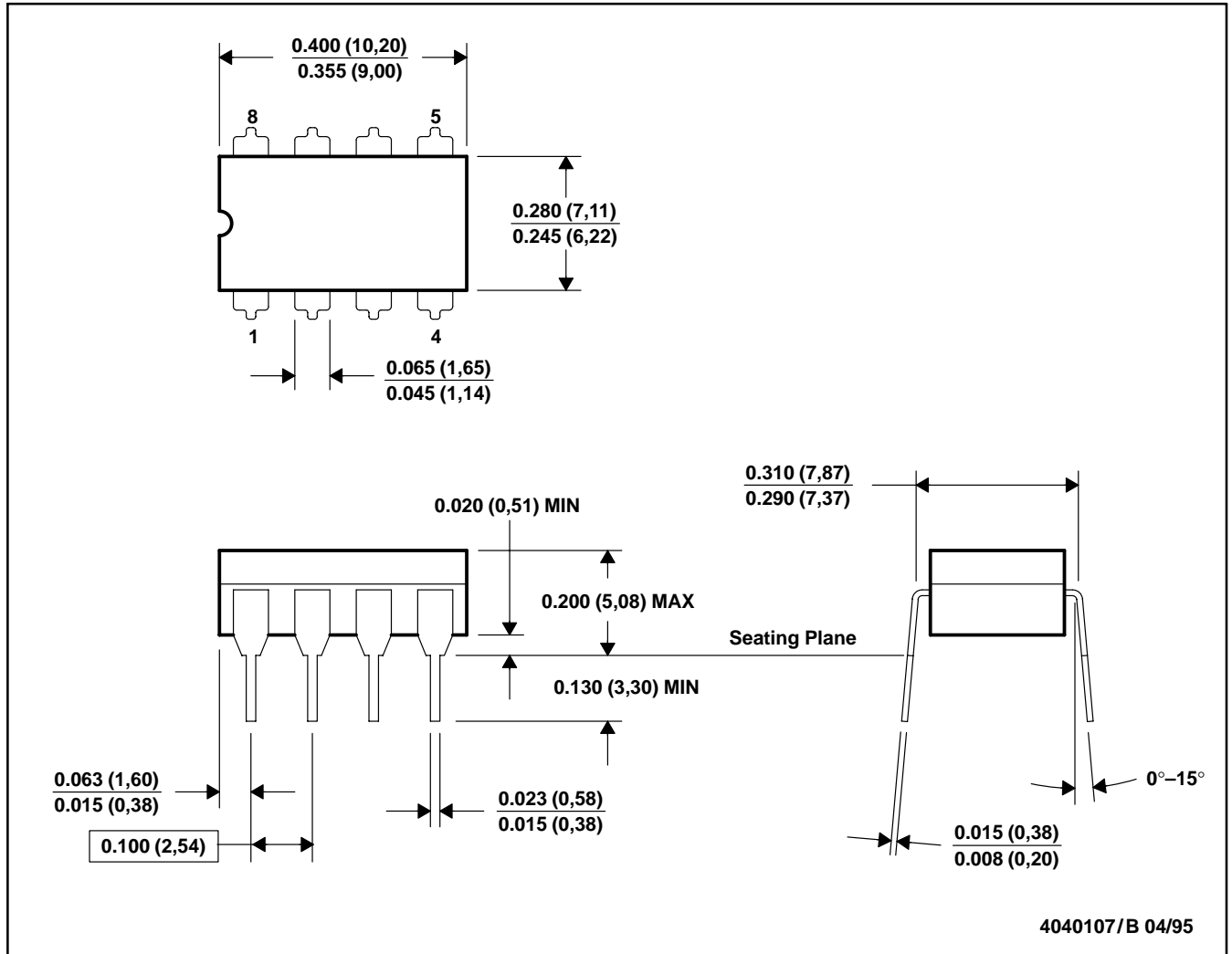

- NOTES: A. All linear dimensions are in inches (millimeters).
 B. This drawing is subject to change without notice.
 C. This package can be hermetically sealed with a ceramic lid using glass frit.
 D. Index point is provided on cap for terminal identification only on press ceramic glass frit seal only
 E. Falls within MIL-STD-1835 GDIP1-T8

TLV226x, TLV226xA
Advanced LinCMOS™ RAIL-TO-RAIL
OPERATIONAL AMPLIFIERS

SLOS186B – FEBRUARY 1997 – REVISED MARCH 2001

MECHANICAL INFORMATION

N (R-PDIP-T)**

PLASTIC DUAL-IN-LINE PACKAGE

16 PIN SHOWN

| DIM \ PINS ** | 14 | 16 | 18 | 20 |
|---------------|------------------|------------------|------------------|------------------|
| A MAX | 0.775 (19,69) | 0.775 (19,69) | 0.920 (23,37) | 0.975 (24,77) |
| A MIN | 0.745 (18,92) | 0.745 (18,92) | 0.850 (21,59) | 0.940 (23,88) |

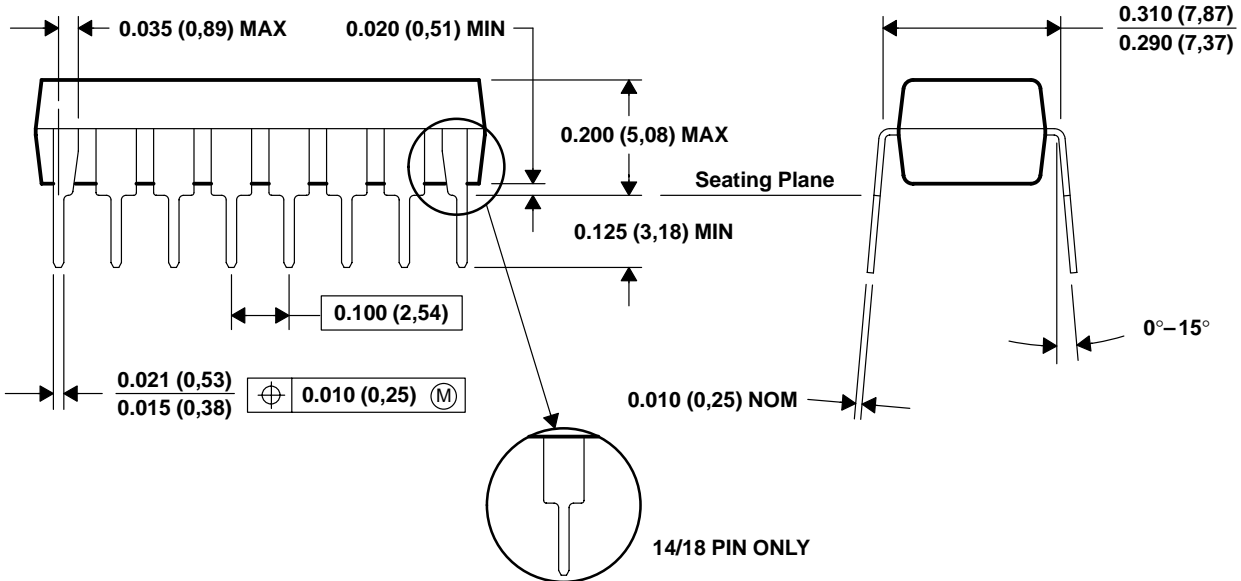
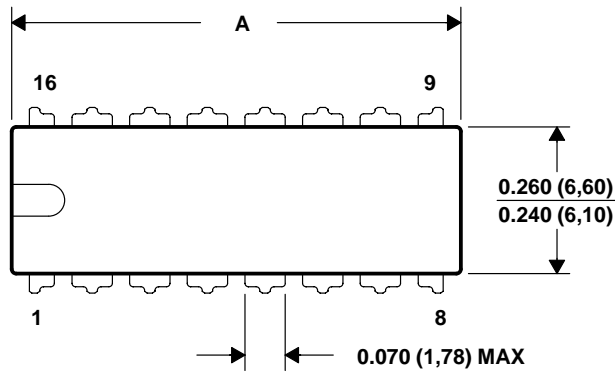

4040049/C 08/95

- NOTES: A. All linear dimensions are in inches (millimeters).
 B. This drawing is subject to change without notice.
 C. Falls within JEDEC MS-001 (20 pin package is shorter than MS-001.)



POST OFFICE BOX 655303 • DALLAS, TEXAS 75265

MECHANICAL INFORMATION

P (R-PDIP-T8)

PLASTIC DUAL-IN-LINE PACKAGE

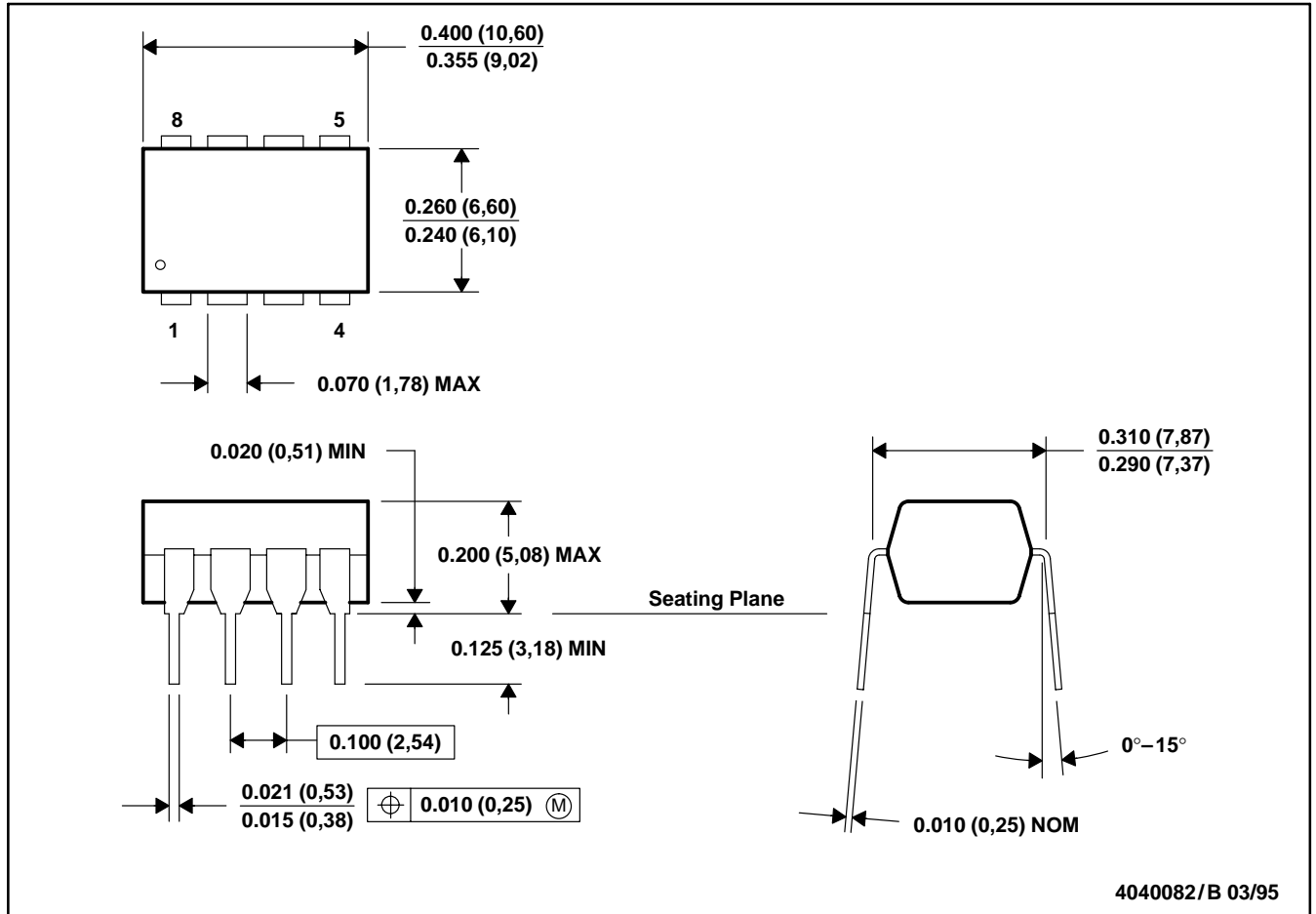

- NOTES: A. All linear dimensions are in inches (millimeters).
 B. This drawing is subject to change without notice.
 C. Falls within JEDEC MS-001

TLV226x, TLV226xA
Advanced LinCMOS™ RAIL-TO-RAIL
OPERATIONAL AMPLIFIERS

SLOS186B – FEBRUARY 1997 – REVISED MARCH 2001

MECHANICAL INFORMATION

PW (R-PDSO-G)**

PLASTIC SMALL-OUTLINE PACKAGE

14 PIN SHOWN

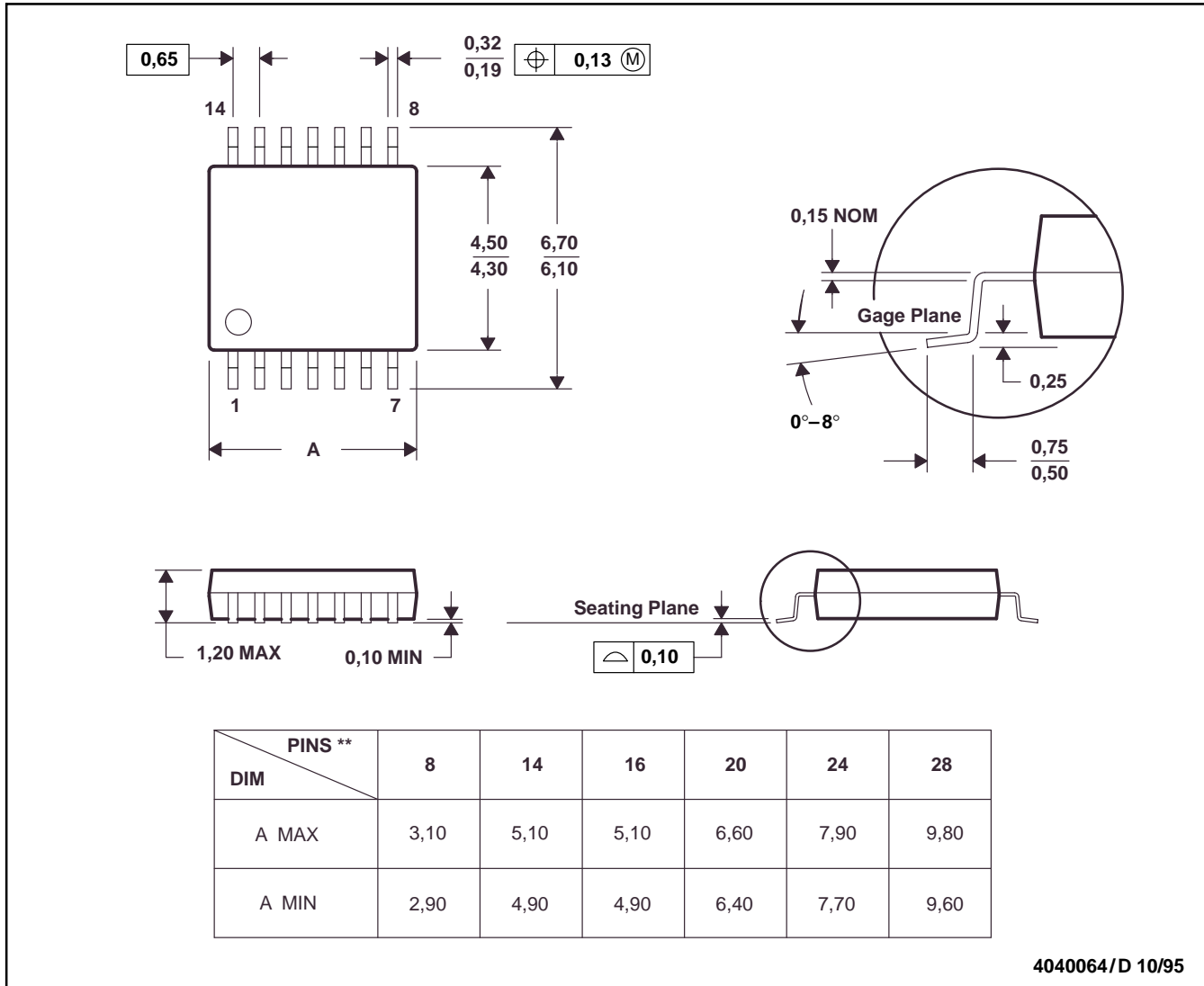

4040064/D 10/95

- NOTES: A. All linear dimensions are in millimeters.
 B. This drawing is subject to change without notice.
 C. Body dimensions do not include mold flash or protrusion not to exceed 0,15.
 D. Falls within JEDEC MO-153

MECHANICAL INFORMATION

U (S-GDFP-F10)

CERAMIC DUAL FLATPACK

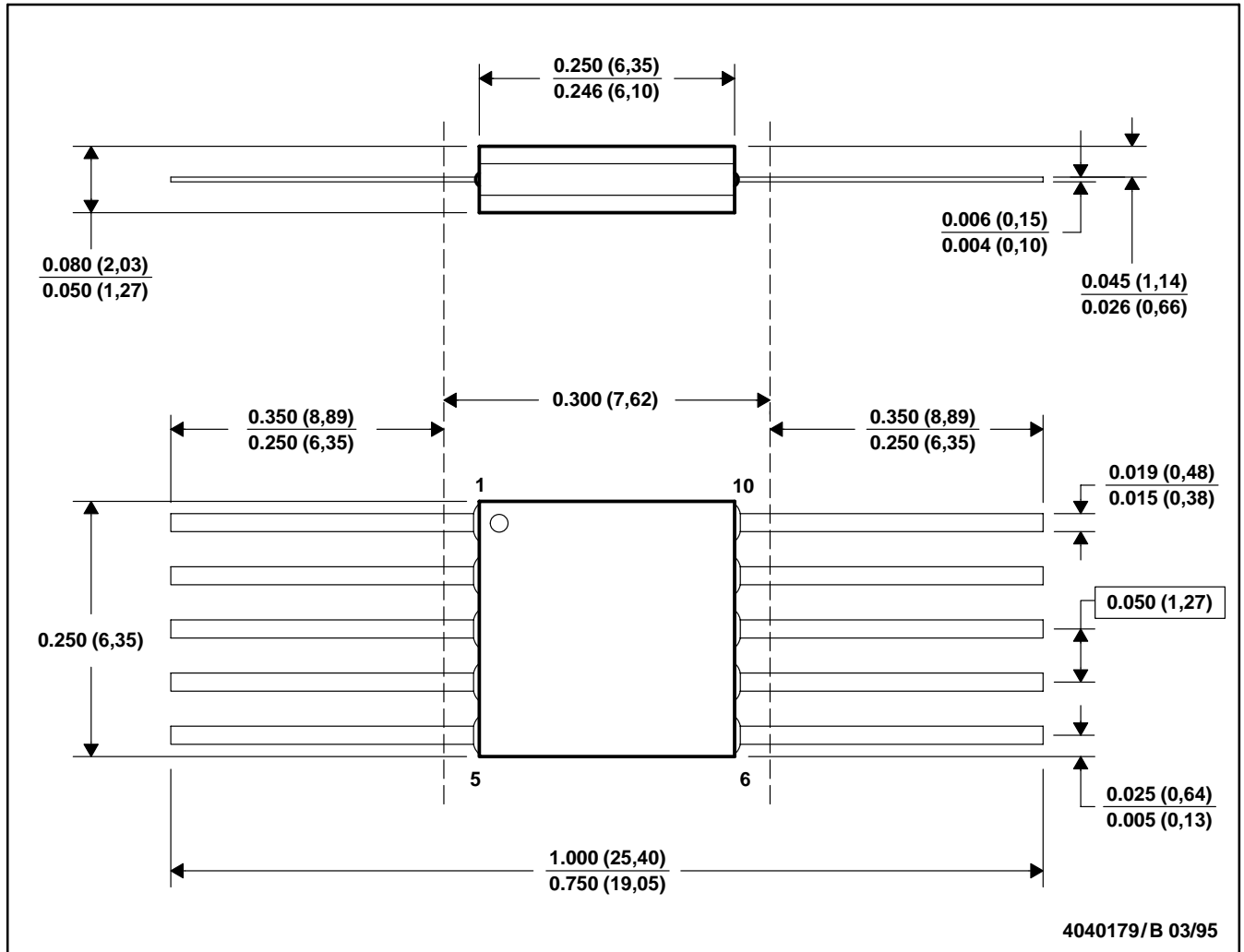

- NOTES: A. All linear dimensions are in inches (millimeters).
 B. This drawing is subject to change without notice.
 C. This package can be hermetically sealed with a ceramic lid using glass frit.
 D. Index point is provided on cap for terminal identification only.
 E. Falls within MIL STD 1835 GDFP1-F10 and JEDEC MO-092AA

TLV226x, TLV226xA
Advanced LinCMOS™ RAIL-TO-RAIL
OPERATIONAL AMPLIFIERS

SLOS186B – FEBRUARY 1997 – REVISED MARCH 2001

MECHANICAL INFORMATION

W (R-GDFP-F16)

CERAMIC DUAL FLATPACK

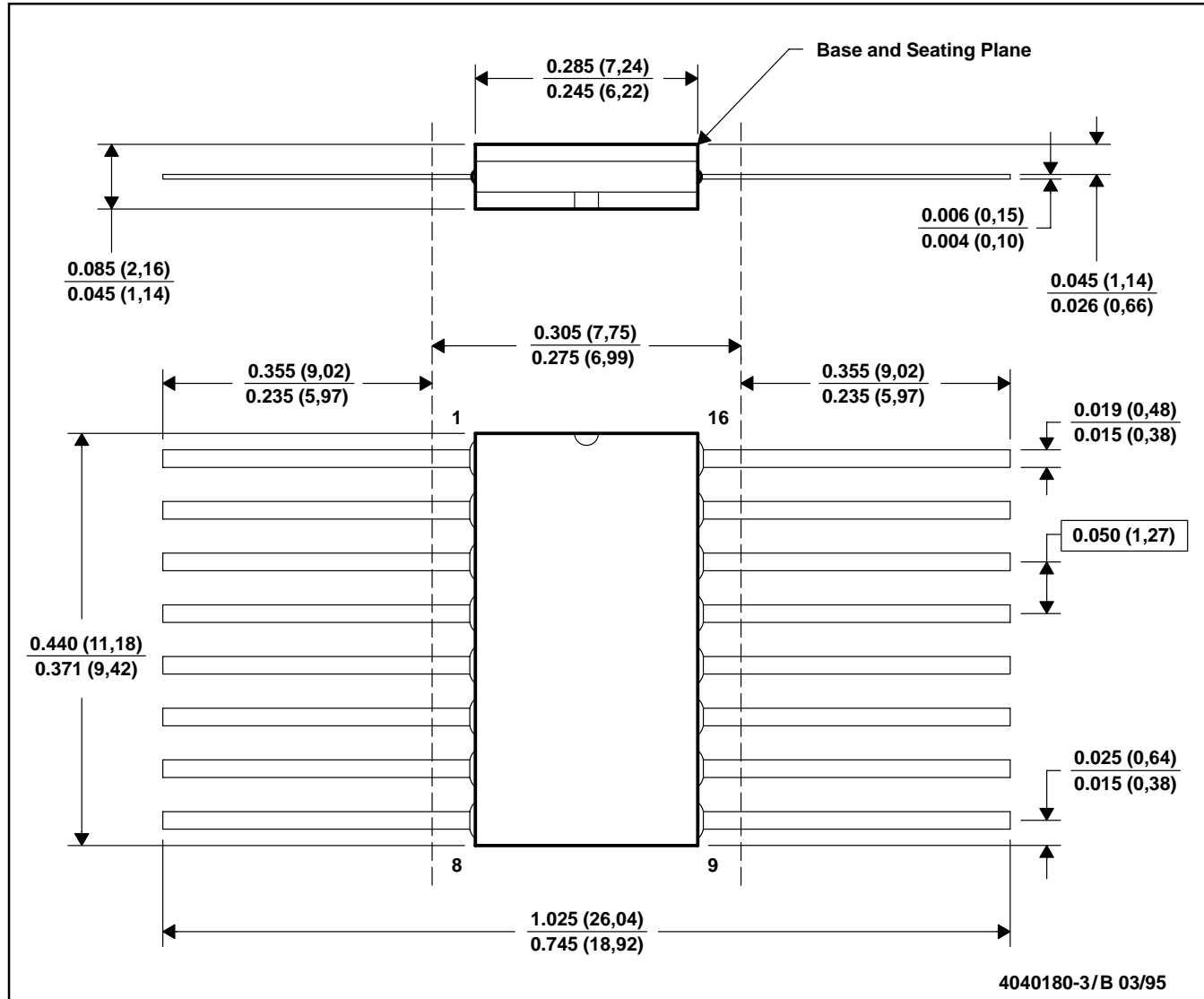

- NOTES: A. All linear dimensions are in inches (millimeters).
 B. This drawing is subject to change without notice.
 C. This package can be hermetically sealed with a ceramic lid using glass frit.
 D. Index point is provided on cap for terminal identification only.
 E. Falls within MIL-STD-1835 GDFP1-F16 and JEDEC MO-092AC



POST OFFICE BOX 655303 • DALLAS, TEXAS 75265

JG (R-GDIP-T8)

CERAMIC DUAL-IN-LINE

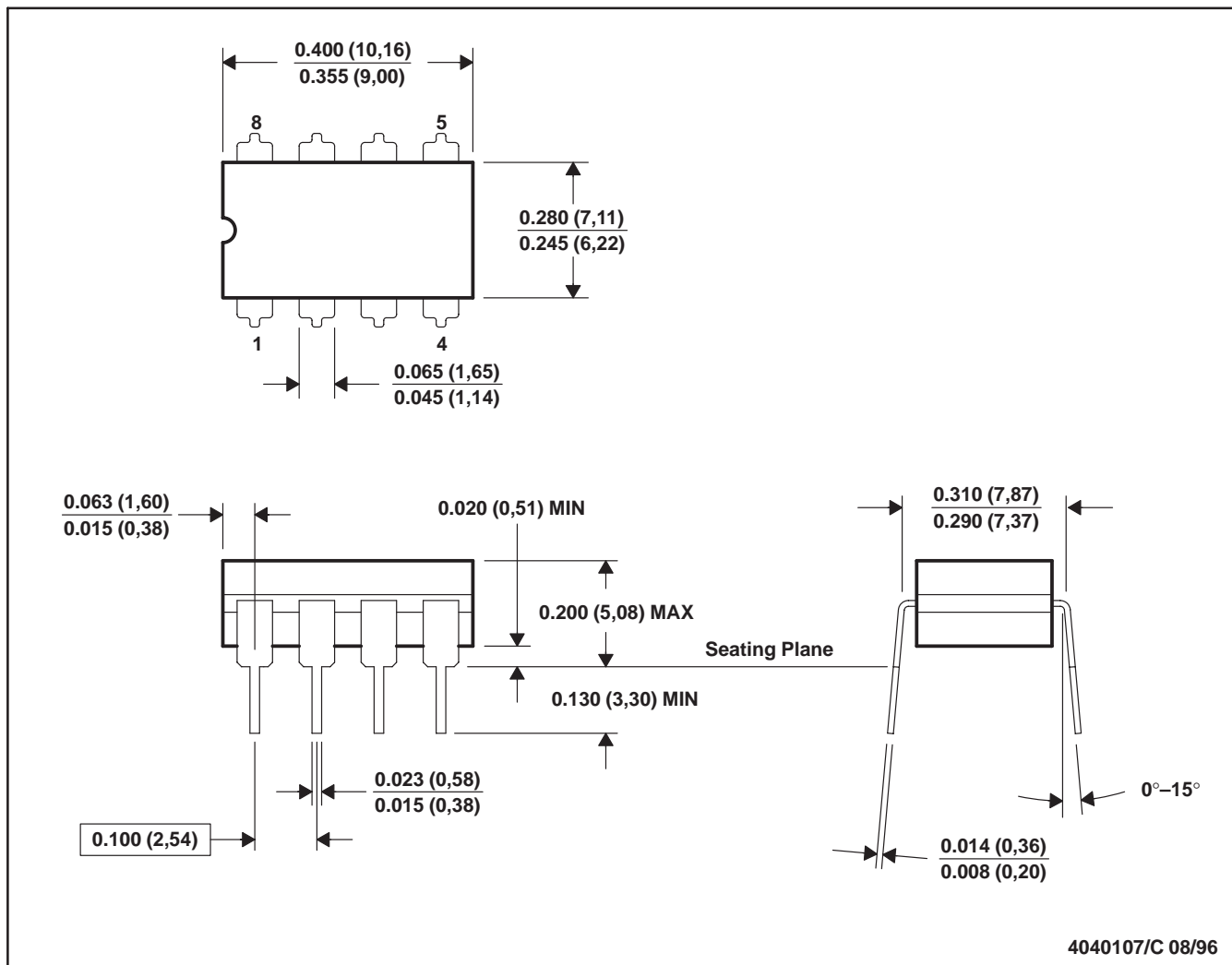

- NOTES: A. All linear dimensions are in inches (millimeters).
 B. This drawing is subject to change without notice.
 C. This package can be hermetically sealed with a ceramic lid using glass frit.
 D. Index point is provided on cap for terminal identification.
 E. Falls within MIL STD 1835 GDIP1-T8

J (R-GDIP-T**)

14 LEADS SHOWN

CERAMIC DUAL IN-LINE PACKAGE

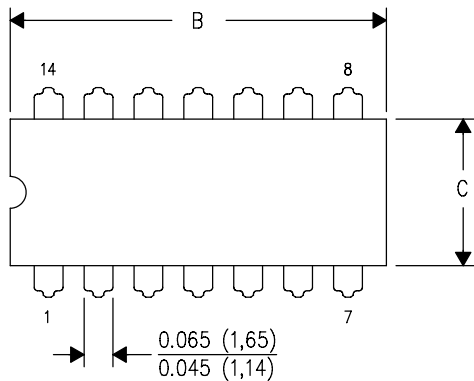

| DIM \ PINS ** | 14 | 16 | 18 | 20 |
|---------------|------------------------|------------------------|------------------------|------------------------|
| A | 0.300 (7,62) BSC | 0.300 (7,62) BSC | 0.300 (7,62) BSC | 0.300 (7,62) BSC |
| B MAX | 0.785 (19,94) | .840 (21,34) | 0.960 (24,38) | 1.060 (26,92) |
| B MIN | — | — | — | — |
| C MAX | 0.300 (7,62) | 0.300 (7,62) | 0.310 (7,87) | 0.300 (7,62) |
| C MIN | 0.245 (6,22) | 0.245 (6,22) | 0.220 (5,59) | 0.245 (6,22) |

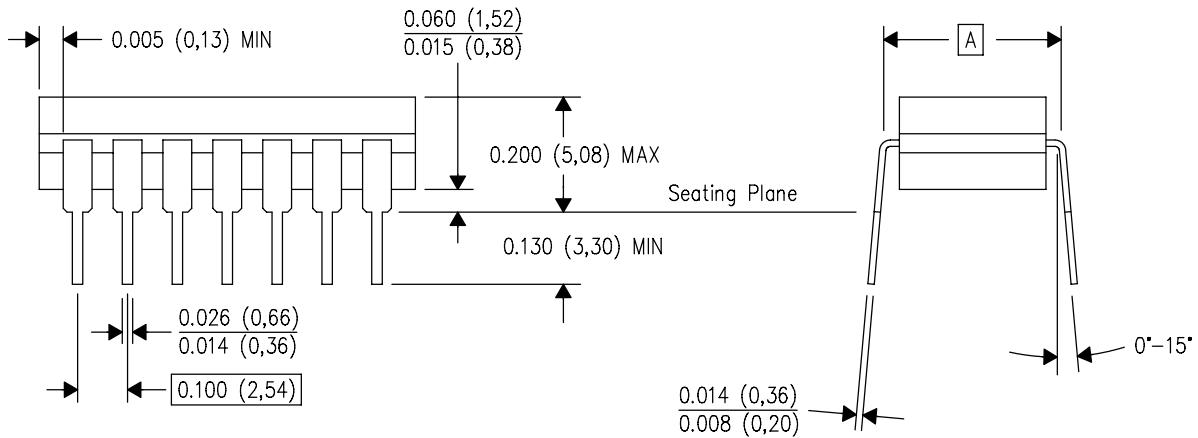

4040083/F 03/03

- NOTES:
- All linear dimensions are in inches (millimeters).
 - This drawing is subject to change without notice.
 - This package is hermetically sealed with a ceramic lid using glass frit.
 - Index point is provided on cap for terminal identification only on press ceramic glass frit seal only.
 - Falls within MIL STD 1835 GDIP1-T14, GDIP1-T16, GDIP1-T18 and GDIP1-T20.

U (S-GDFP-F10)

CERAMIC DUAL FLATPACK

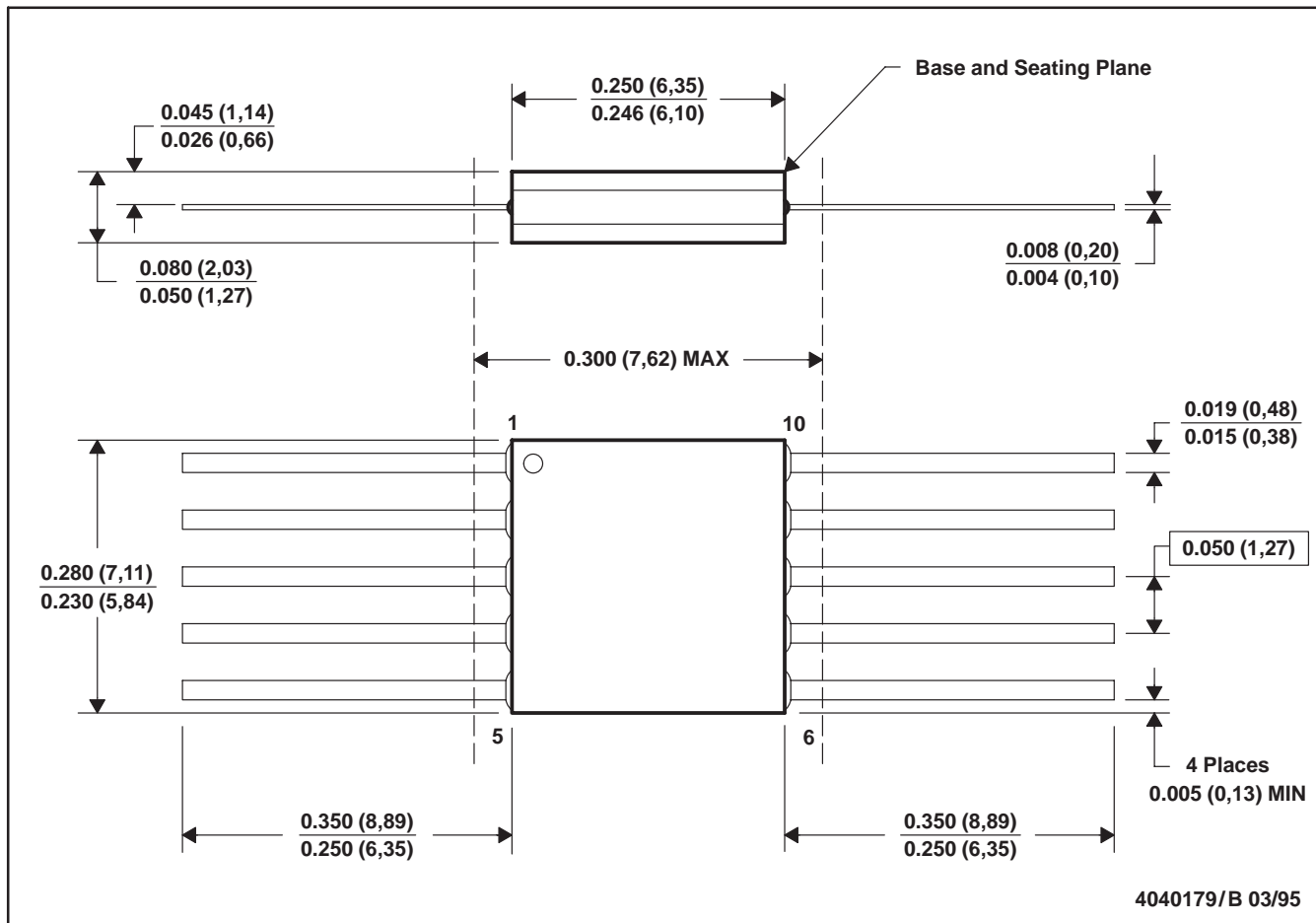

- NOTES: A. All linear dimensions are in inches (millimeters).
 B. This drawing is subject to change without notice.
 C. This package can be hermetically sealed with a ceramic lid using glass frit.
 D. Index point is provided on cap for terminal identification only.
 E. Falls within MIL STD 1835 GDFP1-F10 and JEDEC MO-092AA

W (R-GDFP-F14)

CERAMIC DUAL FLATPACK

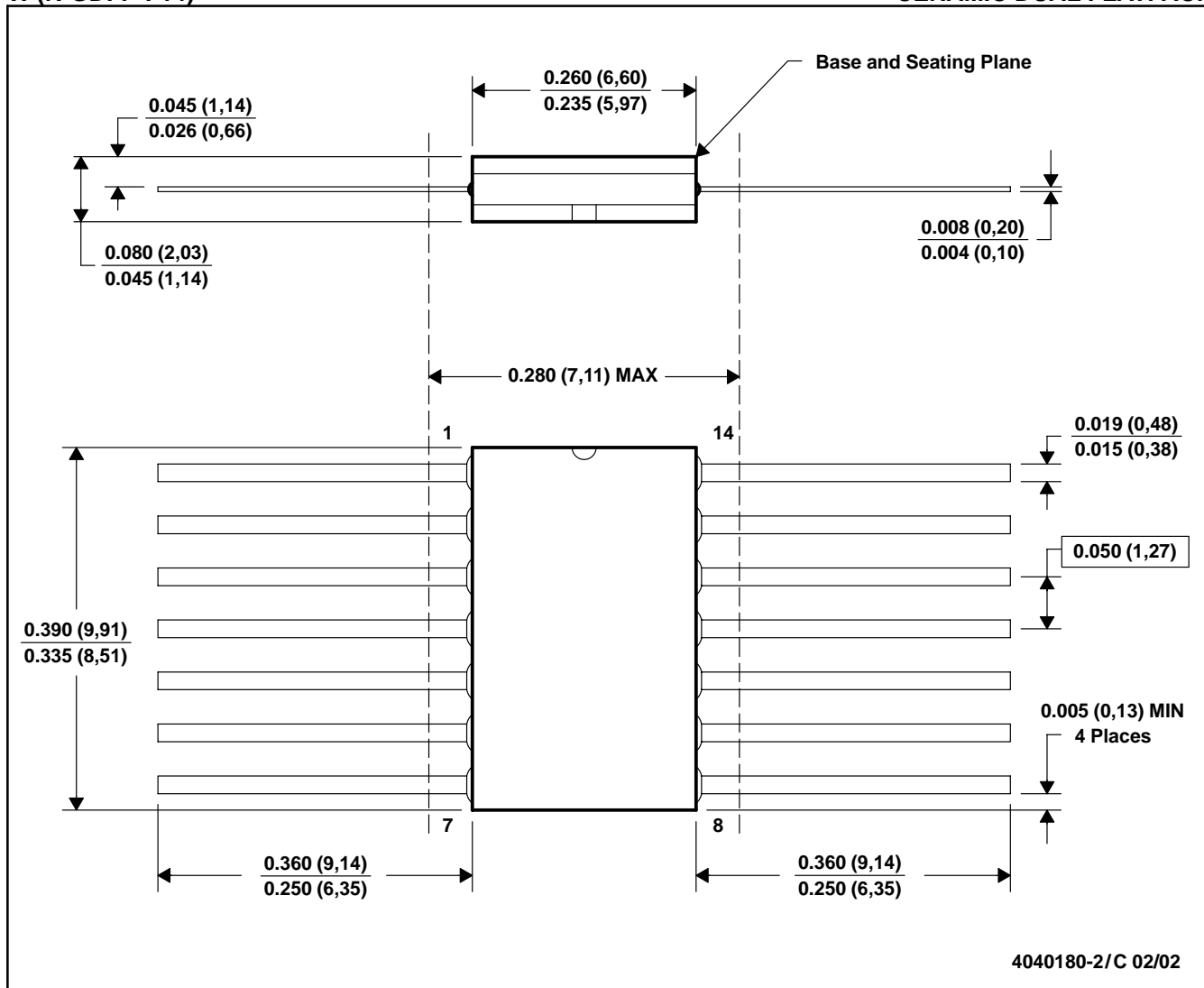

- NOTES: A. All linear dimensions are in inches (millimeters).
 B. This drawing is subject to change without notice.
 C. This package can be hermetically sealed with a ceramic lid using glass frit.
 D. Index point is provided on cap for terminal identification only.
 E. Falls within MIL STD 1835 GDFP1-F14 and JEDEC MO-092AB

FK (S-CQCC-N**)

LEADLESS CERAMIC CHIP CARRIER

28 TERMINAL SHOWN

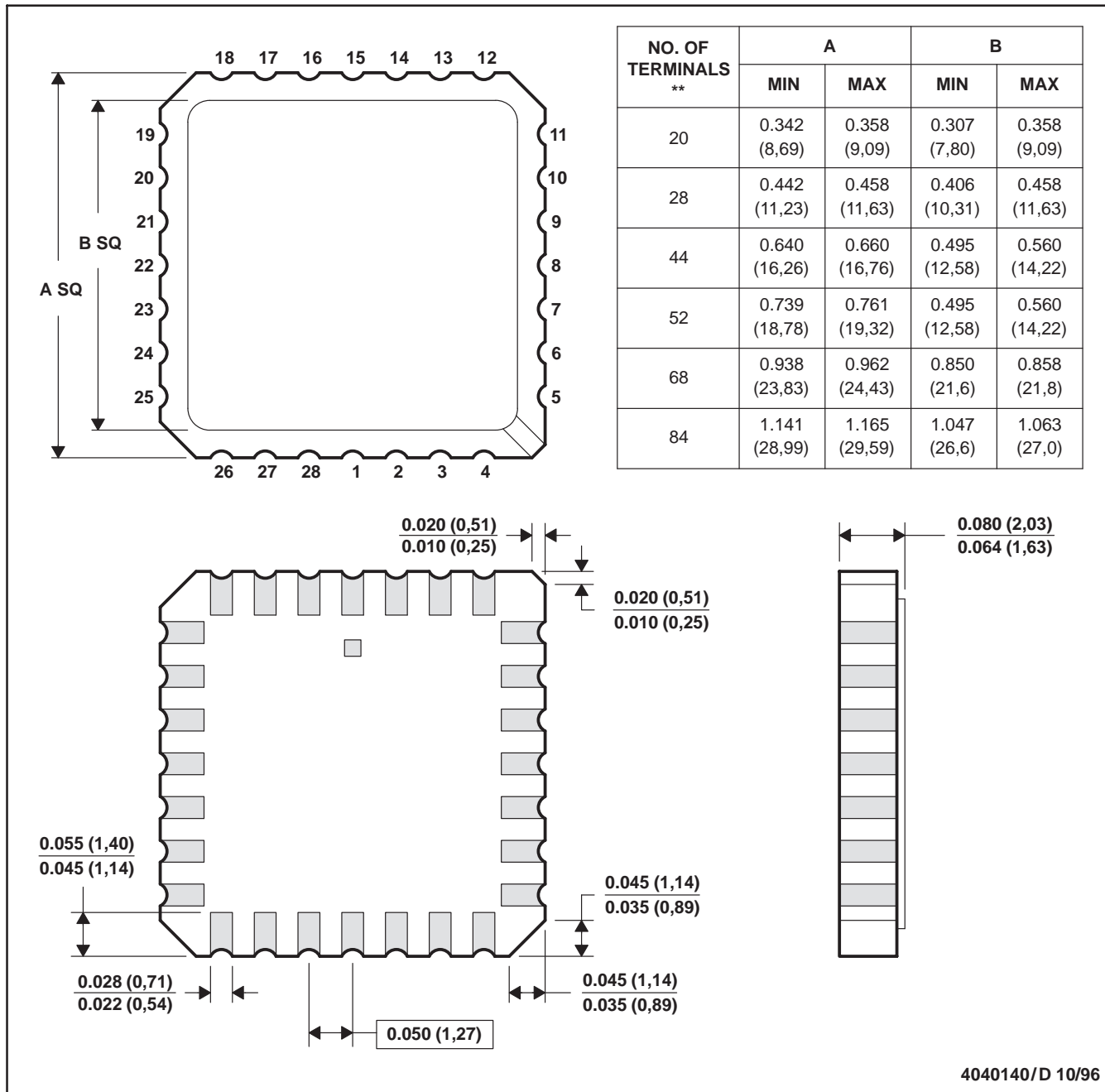

- NOTES:
- A. All linear dimensions are in inches (millimeters).
 - B. This drawing is subject to change without notice.
 - C. This package can be hermetically sealed with a metal lid.
 - D. The terminals are gold plated.
 - E. Falls within JEDEC MS-004

P (R-PDIP-T8)

PLASTIC DUAL-IN-LINE

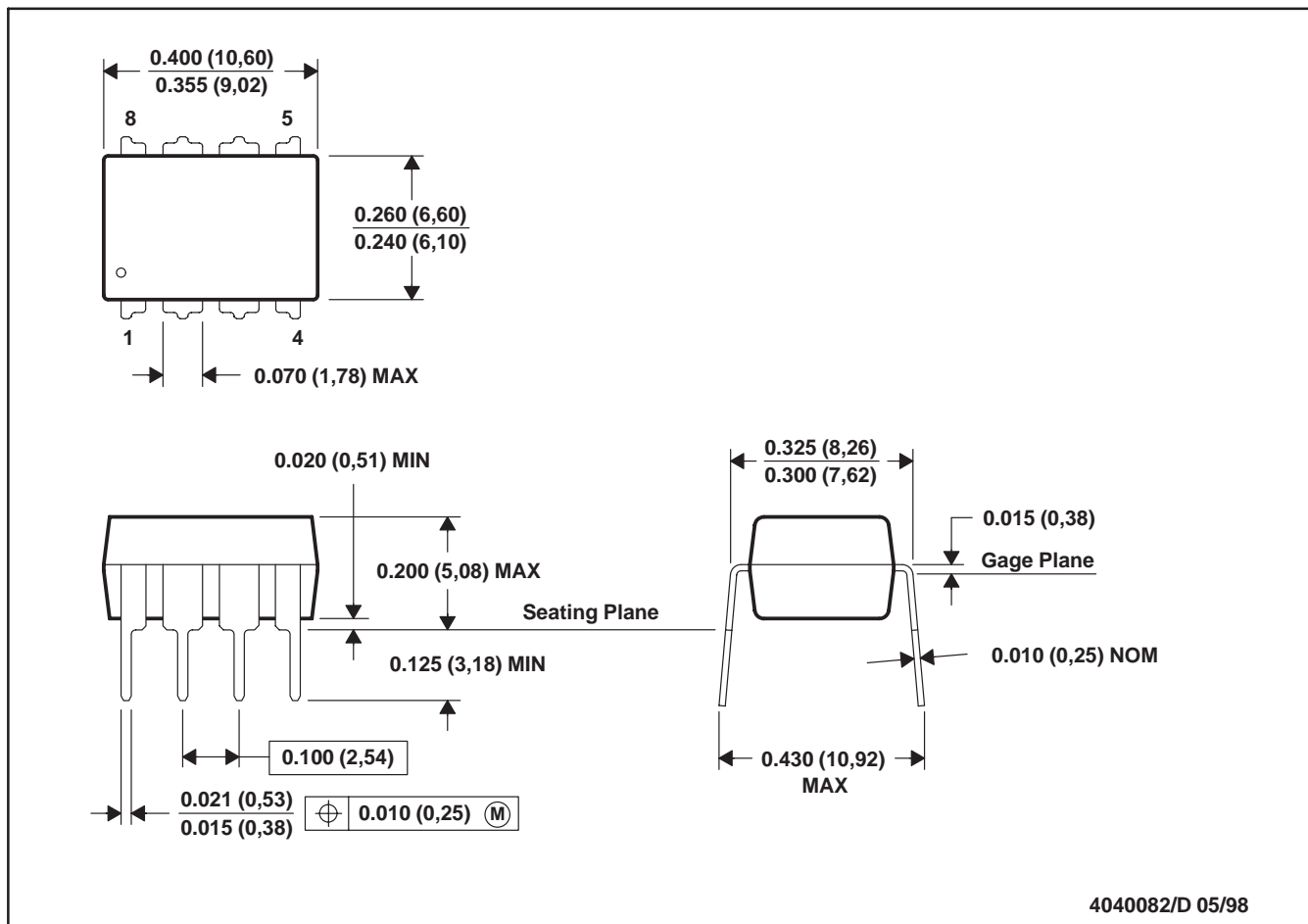

- NOTES: A. All linear dimensions are in inches (millimeters).
 B. This drawing is subject to change without notice.
 C. Falls within JEDEC MS-001

For the latest package information, go to http://www.ti.com/sc/docs/package/pkg_info.htm

N (R-PDIP-T**)

PLASTIC DUAL-IN-LINE PACKAGE

16 PINS SHOWN



- NOTES:
- A. All linear dimensions are in inches (millimeters).
 - B. This drawing is subject to change without notice.
 - C Falls within JEDEC MS-001, except 18 and 20 pin minimum body length (Dim A).
 - D The 20 pin end lead shoulder width is a vendor option, either half or full width.

D (R-PDSO-G14)

PLASTIC SMALL-OUTLINE PACKAGE

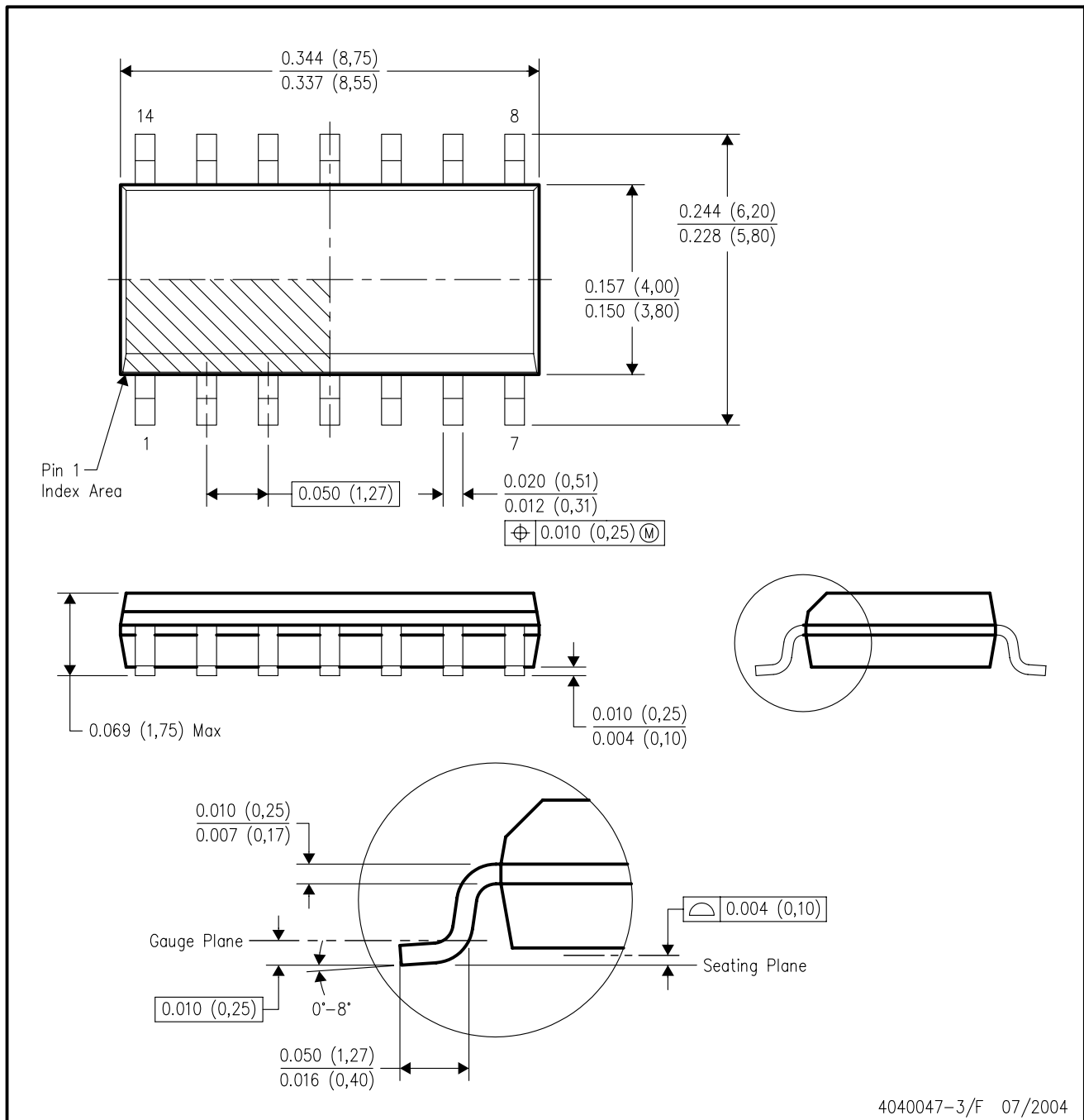

- NOTES:
- A. All linear dimensions are in inches (millimeters).
 - B. This drawing is subject to change without notice.
 - C. Body dimensions do not include mold flash or protrusion not to exceed 0.006 (0,15).
 - D. Falls within JEDEC MS-012 variation AB.

PW (R-PDSO-G**)

PLASTIC SMALL-OUTLINE PACKAGE

14 PINS SHOWN

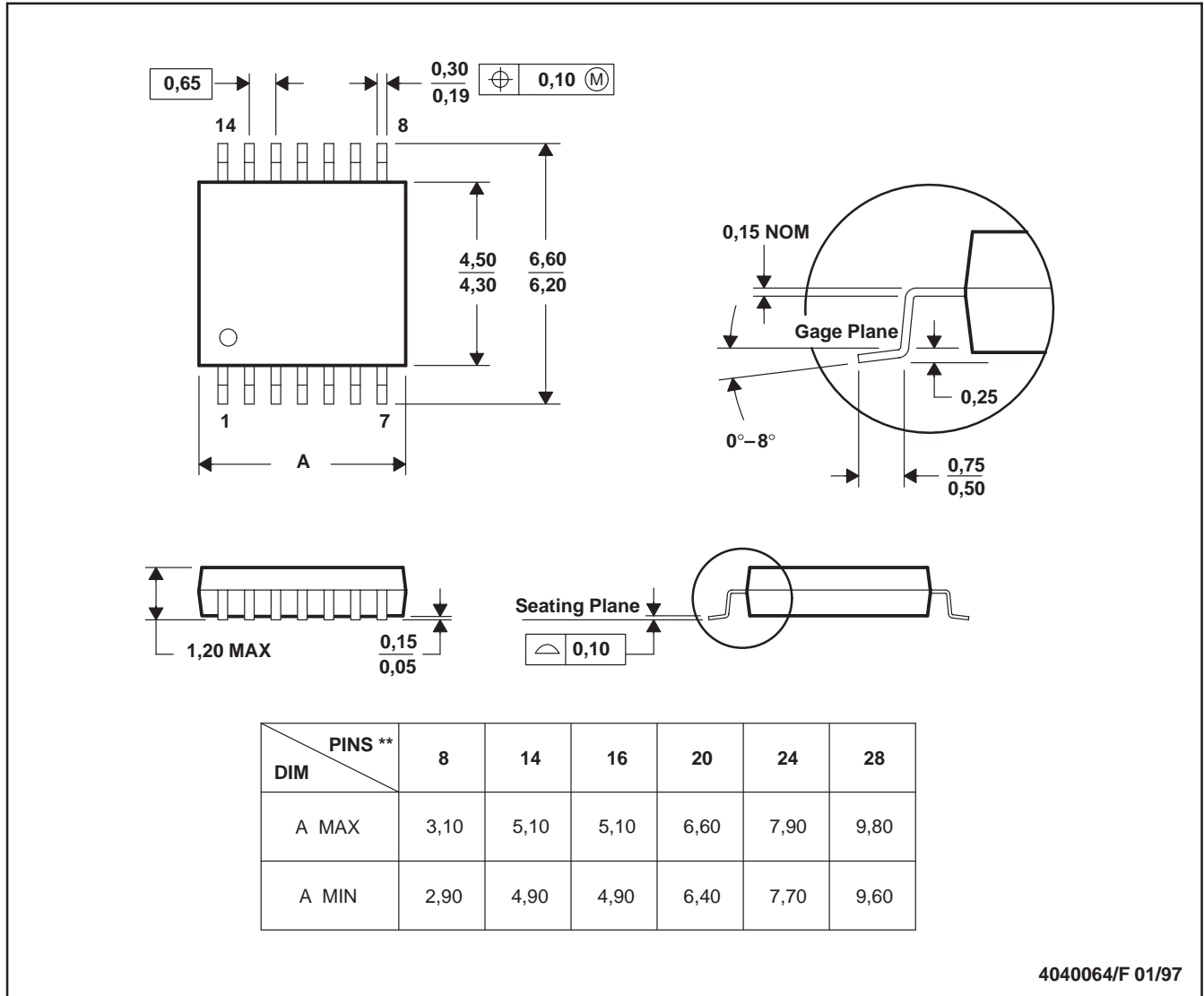

4040064/F 01/97

- NOTES: A. All linear dimensions are in millimeters.
 B. This drawing is subject to change without notice.
 C. Body dimensions do not include mold flash or protrusion not to exceed 0,15.
 D. Falls within JEDEC MO-153

IMPORTANT NOTICE

Texas Instruments Incorporated and its subsidiaries (TI) reserve the right to make corrections, modifications, enhancements, improvements, and other changes to its products and services at any time and to discontinue any product or service without notice. Customers should obtain the latest relevant information before placing orders and should verify that such information is current and complete. All products are sold subject to TI's terms and conditions of sale supplied at the time of order acknowledgment.

TI warrants performance of its hardware products to the specifications applicable at the time of sale in accordance with TI's standard warranty. Testing and other quality control techniques are used to the extent TI deems necessary to support this warranty. Except where mandated by government requirements, testing of all parameters of each product is not necessarily performed.

TI assumes no liability for applications assistance or customer product design. Customers are responsible for their products and applications using TI components. To minimize the risks associated with customer products and applications, customers should provide adequate design and operating safeguards.

TI does not warrant or represent that any license, either express or implied, is granted under any TI patent right, copyright, mask work right, or other TI intellectual property right relating to any combination, machine, or process in which TI products or services are used. Information published by TI regarding third-party products or services does not constitute a license from TI to use such products or services or a warranty or endorsement thereof. Use of such information may require a license from a third party under the patents or other intellectual property of the third party, or a license from TI under the patents or other intellectual property of TI.

Reproduction of information in TI data books or data sheets is permissible only if reproduction is without alteration and is accompanied by all associated warranties, conditions, limitations, and notices. Reproduction of this information with alteration is an unfair and deceptive business practice. TI is not responsible or liable for such altered documentation.

Resale of TI products or services with statements different from or beyond the parameters stated by TI for that product or service voids all express and any implied warranties for the associated TI product or service and is an unfair and deceptive business practice. TI is not responsible or liable for any such statements.

Following are URLs where you can obtain information on other Texas Instruments products and application solutions:

| Products | | Applications | |
|------------------|--|---------------------|--|
| Amplifiers | amplifier.ti.com | Audio | www.ti.com/audio |
| Data Converters | dataconverter.ti.com | Automotive | www.ti.com/automotive |
| DSP | dsp.ti.com | Broadband | www.ti.com/broadband |
| Interface | interface.ti.com | Digital Control | www.ti.com/digitalcontrol |
| Logic | logic.ti.com | Military | www.ti.com/military |
| Power Mgmt | power.ti.com | Optical Networking | www.ti.com/opticalnetwork |
| Microcontrollers | microcontroller.ti.com | Security | www.ti.com/security |
| | | Telephony | www.ti.com/telephony |
| | | Video & Imaging | www.ti.com/video |
| | | Wireless | www.ti.com/wireless |

Mailing Address: Texas Instruments
Post Office Box 655303 Dallas, Texas 75265