

TLC2932A HIGH PERFORMANCE PHASE LOCKED LOOP

SLES150 – OCTOBER 2005

- **VCO (Voltage-Controlled Oscillator):**
 - Complete Oscillator Using Only One External Bias Resistor (RBIAS)
 - Lock Frequency:
 - 13 MHz to 32 MHz (VDD = 3 V ±5%,
T_A = –20°C to 75°C, x1 Output)
 - 13 MHz to 35 MHz (VDD = 3.3 V ±5%,
T_A = –20°C to 75°C, x1 Output)
 - 15 MHz to 55 MHz (VDD = 5 V ±5%,
T_A = –20°C to 75°C, x1 Output)
 - Selectable Output Frequency
- **PFD (Phase Frequency Detector):**
High Speed, Edge-Triggered Detector with Internal Charge Pump

- Independent VCO, PFD Power-Down Mode
- Thin Small-Outline Package (14 Terminal)
- CMOS Technology
- Pin Compatible TLC2932IPW

14-PIN TSOP (PW PACKAGE)
(TOP VIEW)

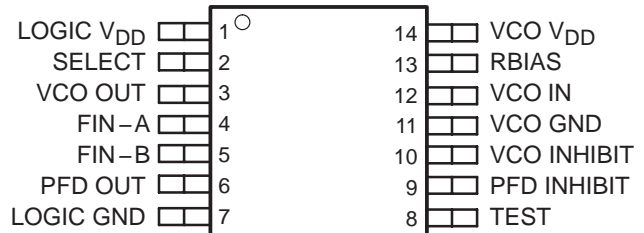

description

The TLC2932A is designed for phase-locked loop (PLL) systems and is composed of a voltage-controlled oscillator (VCO) and an edge-triggered type phase frequency detector (PFD). The oscillation frequency range of the VCO is set by an external bias resistor (R_{BIA}S). The VCO has a 1/2 frequency divider at the output stage. The high speed PFD with internal charge pump detects the phase difference between the reference frequency input and signal frequency input from the external counter. Both the VCO and the PFD have inhibit functions, which can be used as power-down mode. Due to the TLC2932A high speed and stable oscillation capability, the TLC2932A is suitable for use as a high-performance PLL.

AVAILABLE OPTIONS

T _A	PACKAGE
	SMALL OUTLINE (PW)
–20°C to 75°C	TLC2932AIPW



Please be aware that an important notice concerning availability, standard warranty, and use in critical applications of Texas Instruments semiconductor products and disclaimers thereto appears at the end of this data sheet.

PRODUCT PREVIEW information concerns products in the formative or design phase of development. Characteristic data and other specifications are design goals. Texas Instruments reserves the right to change or discontinue these products without notice.

 **TEXAS
INSTRUMENTS**
TI.COM

Copyright © 2005, Texas Instruments Incorporated

TLC2932A HIGH PERFORMANCE PHASE LOCKED LOOP

SLES150 – OCTOBER 2005

functional block diagram

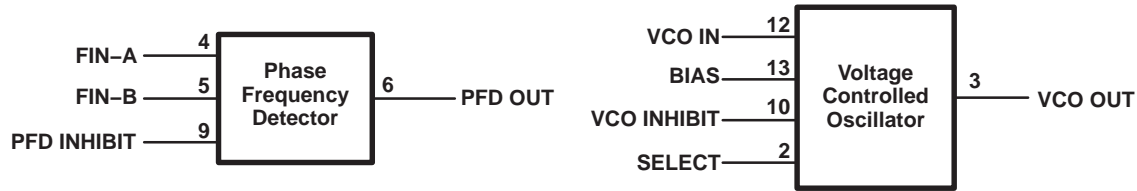

Terminal Functions

TERMINAL NAME	NO.	I/O	DESCRIPTION
LOGIC VDD	1		Power supply for the internal logic. This power supply should be separated from VCO V _{DD} to reduce cross-coupling between supplies.
SELECT	2	I	VCO output frequency select. When SELECT is high, the VCO output frequency is $\times 1/2$ and when low. The output frequency is $\times 1$.
VCO OUT	3	O	VCO output. When the VCO INHIBIT is high, VCO output is low.
FIN-A	4	I	Input reference frequency $f_{(REF IN)}$ is applied to FIN-A.
FIN-B	5	I	Input for VCO external counter output frequency $f_{(FIN-B)}$. FIN-B is nominally provided from the external counter.
PFD OUT	6	O	PFD output. When the PFD INHIBIT is high, PFD output is in the high-impedance state.
LOGIC GND	7		GND for the internal logic.
TEST	8		Connect to GND.
PFD INHIBIT	9	I	PFD inhibit control. When PFD INHIBIT is high, PFD output is in the high-impedance state.
VCO INHIBIT	10	I	VCO inhibit control. When VCO INHIBIT is high, VCO output is low.
VCO GND	11		GND for VCO.
VCO IN	12	I	VCO control voltage input. Nominally the external loop filter output connects to VCO IN to control VCO oscillation frequency.
RBIAS	13	I	Bias supply. An external resistor (R_{BIAS}) between VCO V _{DD} and RBIAS supplies bias for adjusting the oscillation frequency range.
VCO V _{DD}	14		Power supply for VCO. This power supply should be separated from LOGIC V _{DD} to reduce cross-coupling between supplies.

detailed description

VCO oscillation frequency

The VCO oscillation frequency is determined by an external register (R_{BIAS}) connected between the VCO V_{DD} and the BIAS terminals. The oscillation frequency and range depends on this resistor value. For the lock frequency range refer to the recommended operating conditions. Figure 1 shows the typical frequency variation and VCO control voltage.

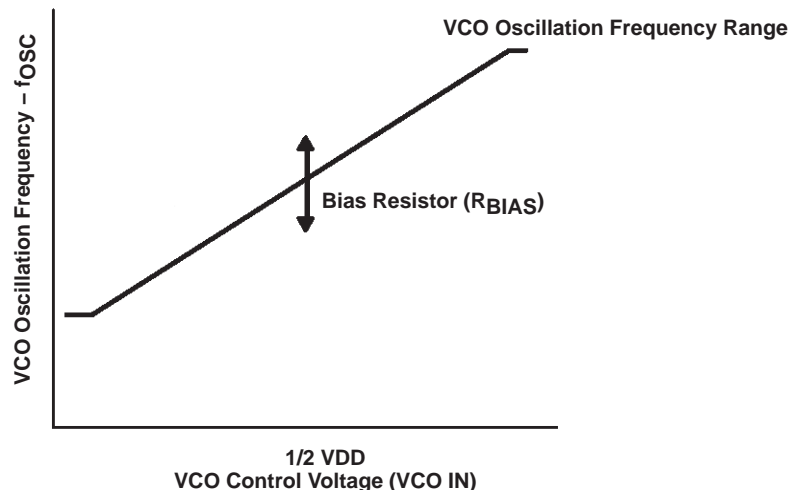

Figure 1. Oscillation Frequency

VCO output frequency 1/2 divider

The TLC2932A SELECT terminal sets the f_{OSC} VCO output frequency as shown in Table 1. The $1/2 f_{OSC}$ output should be used for minimum VCO output jitter.

Table 1. VCO Output 1/2 Divider Function

SELECT	VCO OUTPUT
Low	f_{OSC}
High	$1/2 f_{OSC}$

VCO inhibit function

The VCO has an externally controlled inhibit function which inhibit the VCO output. A high level on the VCO INHIBIT terminal stops the VCO oscillation and powers down the VCO. The output maintains a low level during the power-down mode as shown in Table 2.

Table 2. VCO Inhibit Function

VCO INHIBIT	VCO OSCILLATOR	VCO OUT	$I_{DD}(VCO)$
Low	Active	Active	Normal
High	Stopped	Low level	Power Down

PFD operation

The PFD is a high-speed, edge-triggered detector with an internal charge pump. The PFD detects the phase difference between two frequency inputs supplied to FIN-A and FIN-B as shown in Figure 2. Normally the reference is supplied to FIN-A and the frequency from the external counter output is fed to FIN-B. For clock recovery PLL system, other types of phase detectors should be used.

TLC2932A HIGH PERFORMANCE PHASE LOCKED LOOP

SLES150 – OCTOBER 2005

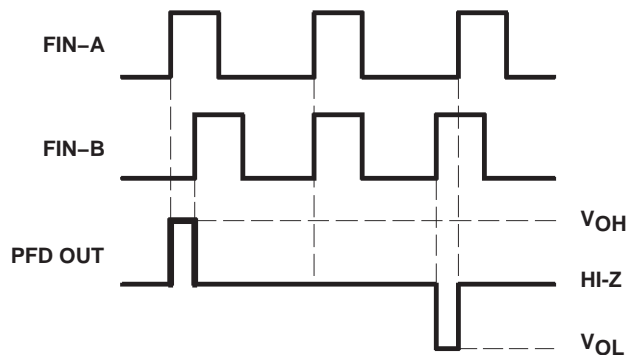

Figure 2. PFD Function Timing Chart

PFD inhibit control

A high level on the PFD INHIBIT terminal places PFD OUT in the high-impedance state and the PFD stops phase detection as shown in Table 3. A high level on the PFD INHIBIT terminal can also be used as the power-down mode for the PFD.

Table 3. VCO Output Control Function

PFD INHIBIT	DETECTION	PFD OUT	I _{DD} (PFD)
Low	Active	Active	Normal
High	Stopped	Hi-Z	Power Down

VCO block schematic

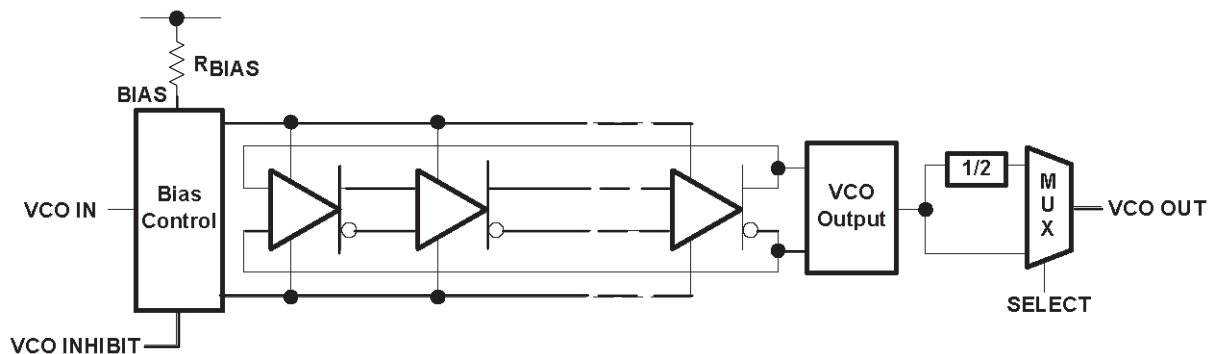

PFD block schematic

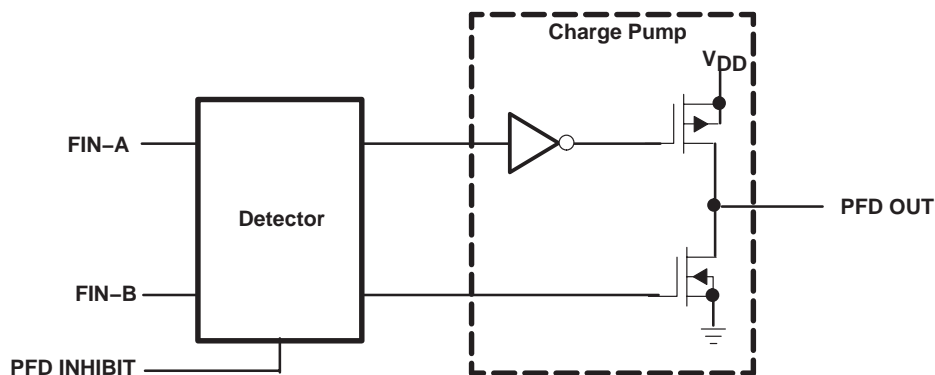

absolute maximum ratings over operating free-air temperature range (unless otherwise noted)†

Supply voltage (each supply), V_{DD} (see Note 1)	7 V
Input voltage range (each input), V_{IN} (see Note 1)	-0.5 V to $V_{DD} + 0.5$ V
Input current (each input), I_{IN}	± 20 mA
Output current (each output), I_O	± 20 mA
Operating free-air temperature range, T_A	-20°C to 75°C
Storage temperature range, T_{Stg}	-65°C to 150°C

† Stresses beyond those listed under “absolute maximum ratings” may cause permanent damage to the device. These are stress ratings only, and functional operation of the device at these or any other conditions beyond those indicated under “recommended operating conditions” is not implied. Exposure to absolute-maximum-rated conditions for extended periods may affect device reliability.

- NOTES: 1. All voltages are with respect to GND.
2. For operation above 25°C free-air temperature, derate linearly at the rate of 5.6 mW/°C.

recommended operating conditions

PARAMETERS		MIN	TYP	MAX	UNIT
Supply voltage (each supply, see Note 3)	$V_{DD} = 3$ V	2.85	3	3.15	V
	$V_{DD} = 3.3$ V	3.135	3.3	3.465	
	$V_{DD} = 5$ V	4.75	5	5.25	
Input voltage, (inputs except VCO IN)		0		V_{DD}	V
Output current, (each output)		0		± 2	mA
VCO control voltage at VCO IN		0.9		V_{DD}	V
Lock frequency	$V_{DD} = 3$ V	13		32	MHz
	$V_{DD} = 3.3$ V	13		35	
	$V_{DD} = 5$ V	15		55	
Bias Resistor	$V_{DD} = 3$ V	2.2		5.1	k Ω
	$V_{DD} = 3.3$ V	2.2		5.1	
	$V_{DD} = 5$ V	2.2		5.1	

NOTE 3: It is recommended that the logic supply terminal (LOGIC V_{DD}) and the VCO supply terminal (VCO V_{DD}) should be at the same voltage and separated from each other.

electrical characteristics, $V_{DD} = 3$ V, $T_A = 25^\circ\text{C}$ (unless otherwise noted)

VCO section

PARAMETER		TEST CONDITIONS	MIN	TYP	MAX	UNIT
V_{OH}	High level output voltage	$I_{OH} = -2$ mA	2.4			V
V_{OL}	Low level output voltage	$I_{OL} = 2$ mA			0.3	V
V_{TH}	Input threshold voltage at select, VCO inhibit		0.9	1.5	2.1	V
I_I	Input current at Select, VCO inhibit	$V_I = V_{DD}$ or GND			± 1	μA
$Z_I(\text{VCON})$	VCO IN input impedance	VCO IN = 1/2 V_{DD}		10		M Ω
$I_{DD}(\text{INH})$	VCO supply current (inhibit)	See Note 4		0.35	1	μA
$I_{DD}(\text{VCO})$	VCO supply current	See Note 5		8.4	17	mA

- NOTES: 4. Current into VCO V_{DD} , when VCO INHIBIT = high, PFD is inhibited.
5. Current into VCO V_{DD} , when VCO IN = 1/2 V_{DD} , $R_{BIAS} = 3.3$ k Ω , VCOOUT = 15-pF Load, VCO INHIBIT = GND, and PFD INHIBIT = GND.

TLC2932A

HIGH PERFORMANCE PHASE LOCKED LOOP

SLES150 – OCTOBER 2005

electrical characteristics, $V_{DD} = 3\text{ V}$, $T_A = 25^\circ\text{C}$ (unless otherwise noted) (continued)

PFD section

PARAMETER	TEST CONDITIONS	MIN	TYP	MAX	UNIT
V_{OH}	High level output voltage	$I_{OH} = -2\text{ mA}$		2.4	V
V_{OL}	Low level output voltage	$I_{OL} = 2\text{ mA}$		0.3	V
I_{OZ}	High impedance state output current	PFD inhibit = high, $V_O = V_{DD}$ or GND		± 1	μA
V_{IH}	High level input voltage at Fin-A, Fin-B			2.1	V
V_{IL}	Low level input voltage at Fin-A, Fin-B			0.5	V
V_{TH}	Input threshold voltage at PFD inhibit	0.9	1.5	2.1	
C_{IN}	Input capacitance at Fin-A, Fin-B			5.6	pF
Z_{IN}	Input impedance at Fin-A, Fin-B			10	$M\Omega$
$I_{DD(Z)}$	High impedance state PFD supply current	See Note 6		1	μA
$I_{DD(PFD)}$	PFD supply current	See Note 7		3	mA

NOTES: 6. The current into LOGIC V_{DD} when FIN-A and FIN-B = ground, PFD INHIBIT = V_{DD} , PFD OUT open, and VCO OUT is inhibited.
7. The current into LOGIC V_{DD} when FIN-A = 1 MHz and FIN-B = 1 MHz ($V_{I(PP)} = 3\text{ V}$, rectangular wave), PFD INHIBIT = GND, PFD OUT open, and VCO OUT is inhibited.

operation characteristics, $V_{DD} = 3\text{ V}$, $T_A = 25^\circ\text{C}$ (unless otherwise noted)

VCO section

Parameter	TEST CONDITIONS	MIN	TYP	MAX	UNIT		
f_{OSC}	Operation oscillation frequency	$R_{BIAS} = 3.3\text{ k}\Omega$, VCO IN = $1/2 V_{DD}$		17	25	33	MHz
f_{STB}	Time to stable oscillation (see Note 8)					10	μs
t_r	Rise time	$C_L = 15\text{ pF}$			9	14	ns
t_f	Fall time	$C_L = 15\text{ pF}$			7.6	12	ns
	Duty cycle at VCO OUT	$R_{BIAS} = 3.3\text{ k}\Omega$, VCO IN = $1/2 V_{DD}$		45%	50%	55%	
$\alpha (f_{OSC})$	Temperature coefficient of oscillation frequency	VCO IN = $1/2 V_{DD}$, $T_A = -20^\circ\text{C}$ to 75°C			-0.264		$\%/^\circ\text{C}$
k_{SVS} (fosc)	Supply voltage coefficient of oscillation frequency	VCO IN = $1/2 V_{DD}$, $V_{DD} = 4.75\text{ V}$ to 5.25 V			0.004		$\%/mV$
	Jitter absolute (see Note 9)	PLL jitter, N = 128			325		ps

NOTES: 8. The time period to the stable VCO oscillation frequency after the VCO INHIBIT terminal is changed to a low level.
9. Jitter performance is highly dependent on circuit layout and external device characteristics. The jitter specification was made with a carefully designed PCB with no device socket.

PFD section

PARAMETER	TEST CONDITIONS	MIN	TYP	MAX	UNIT		
f_{max}	Maximum operation frequency			17	MH		
t_{PLZ}	PFD output disable time from low level			22	50	ns	
t_{PHZ}	PFD output disable time from high level			21	50	ns	
t_{PZL}	PFD output enable time to low level			6.5	30	ns	
t_{PZH}	PFD output enable time to high level			7	30	ns	
t_r	Rise time	$C_L = 15\text{ pF}$			3.4	10	ns
t_f	Fall time	$C_L = 15\text{ pF}$			1.9	10	ns



electrical characteristics, $V_{DD} = 3.3\text{ V}$, $T_A = 25^\circ\text{C}$ (unless otherwise noted)

VCO section

	PARAMETER	TEST CONDITIONS	MIN	TYP	MAX	UNIT
V_{OH}	High level output voltage	$I_{OH} = -2\text{ mA}$	2.64			V
V_{OL}	Low level output voltage	$I_{OL} = 2\text{ mA}$			0.33	V
V_{TH}	Input threshold voltage at select, VCO inhibit		1.05	1.65	2.25	V
I_I	Input current at Select, VCO inhibit	$V_I = V_{DD}$ or GND			± 1	μA
$Z_I(\text{VCON})$	VCO IN input impedance	VCO IN = $1/2 V_{DD}$		10		$\text{M}\Omega$
$I_{DD}(\text{INH})$	VCO supply current (inhibit)	See Note 10		0.38	1	μA
$I_{DD}(\text{VCO})$	VCO supply current	See Note 11		10.8	22	mA

NOTES: 10. Current into VCO V_{DD} , when VCO INHIBIT = high, PFD is inhibited.

11. Current into VCO V_{DD} , when VCO IN = $1/2 V_{DD}$, $R_{BIAS} = 3.3\text{ k}\Omega$, VCOOUT = 15-pF Load, VCO INHIBIT = GND, and PFD INHIBIT = GND.

PFD section

	PARAMETER	TEST CONDITIONS	MIN	TYP	MAX	UNIT
V_{OH}	High level output voltage	$I_{OH} = -2\text{ mA}$	2.97			V
V_{OL}	Low level output voltage	$I_{OL} = 2\text{ mA}$			0.2	V
I_{OZ}	High impedance state output current	PFD inhibit = high, $V_O = V_{DD}$ or GND			± 1	μA
V_{IH}	High level input voltage at Fin-A, Fin-B		2.1			V
V_{IL}	Low level input voltage at Fin-A, Fin-B				0.5	V
V_{TH}	Input threshold voltage at PFD inhibit		1.05	1.65	2.25	
C_{IN}	Input capacitance at Fin-A, Fin-B			5.6		pF
Z_{IN}	Input impedance at Fin-A, Fin-B			10		$\text{M}\Omega$
$I_{DD}(Z)$	High impedance state PFD supply current	See Note 12			1	μA
$I_{DD}(\text{PFD})$	PFD supply current	See Note 13			3	mA

NOTES: 12. The current into LOGIC V_{DD} when FIN-A and FIN-B = ground, PFD INHIBIT = V_{DD} , PFD OUT open, and VCO OUT is inhibited.

13. The current into LOGIC V_{DD} when FIN-A = 1 MHz and FIN-B = 1 MHz ($V_{I(\text{PP})} = 3.3\text{ V}$, rectangular wave), PFD INHIBIT = GND, PFD OUT open, and VCO OUT is inhibited.

operation characteristics, $V_{DD} = 3.3\text{ V}$, $T_A = 25^\circ\text{C}$ (unless otherwise noted)

VCO section

	PARAMETER	TEST CONDITIONS	MIN	TYP	MAX	UNIT
f_{OSC}	Operation oscillation frequency	$R_{BIAS} = 3.3\text{ k}\Omega$, VCO IN = $1/2 V_{DD}$	18	30	43	MHz
t_{stb}	Time to stable oscillation (see Note 14)				10	μs
t_r	Rise time	$C_L = 15\text{ pF}$		8.5	14	ns
t_f	Fall time	$C_L = 15\text{ pF}$		7.3	12	ns
f_{DUTY}	Duty cycle at VCO OUT	$R_{BIAS} = 3.3\text{ k}\Omega$, VCO IN = $1/2 V_{DD}$	45	50	55	%
$\alpha(f_{\text{OSC}})$	Temperature coefficient of oscillation frequency	VCO IN = $1/2 V_{DD}$, $T_A = -20^\circ\text{C}$ to 75°C		-0.28 7		$\%/^\circ\text{C}$
$k_{\text{SVS}}(f_{\text{OSC}})$	Supply voltage coefficient of oscillation frequency	VCO IN = $1/2 V_{DD}$, $V_{DD} = 4.75\text{ V}$ to 5.25 V		0.004		$\%/m\text{V}$
	Jitter absolute (see Note 15)	PLL jitter, N = 128		245		ps

NOTES: 14. The time period to the stable VCO oscillation frequency after the VCO INHIBIT terminal is changed to a low level.

15. Jitter performance is highly dependent on circuit layout and external device characteristics. The jitter specification was made with a carefully deigned PCB with no device socket.

TLC2932A

HIGH PERFORMANCE PHASE LOCKED LOOP

SLES150 – OCTOBER 2005

operation characteristics, $V_{DD} = 3.3\text{ V}$, $T_A = 25^\circ\text{C}$ (unless otherwise noted) (continued)

PFD section

PARAMETER	TEST CONDITIONS	MIN	TYP	MAX	UNIT
f_{max}	Maximum operation frequency	22			MHz
t_{PLZ}	PFD output disable time from low level		21	50	ns
t_{PHZ}	PFD output disable time from high level		21	50	ns
t_{PZL}	PFD output enable time to low level		5.8	30	ns
t_{PZH}	PFD output enable time to high level		6.2	30	ns
t_r	Rise time	$C_L = 15\text{ pF}$	3	10	ns
t_f	Fall time	$C_L = 15\text{ pF}$	1.7	10	ns

electrical characteristics, $V_{DD} = 5\text{ V}$, $T_A = 25^\circ\text{C}$ (unless otherwise noted)

VCO section

PARAMETER	TEST CONDITIONS	MIN	TYP	MAX	UNIT	
V_{OH}	High level output voltage	$I_{OH} = -2\text{ mA}$	4		V	
V_{OL}	Low level output voltage	$I_{OL} = 2\text{ mA}$		0.5	V	
V_{TH}	Input threshold voltage at select, VCO inhibit		1.5	2.5	3.5	V
I_I	Input current at Select, VCO inhibit	$V_I = V_{DD}$ or GND		± 1	μA	
$Z_I(\text{VCOIN})$	VCO IN input impedance	$V_{CO\ IN} = 1/2 V_{DD}$	10		M(Ω)	
$I_{DD}(\text{inh})$	VCO supply current (inhibit)	See Note 16	0.56	1	μA	
$I_{DD}(\text{vco})$	VCO supply current	See Note 17	28	50	mA	

NOTES: 16. Current into VCO V_{DD} , when VCO INHIBIT = high, PFD is inhibited.

17. Current into VCO V_{DD} , when VCO IN = $1/2 V_{DD}$, $R_{BIAS} = 3.3\text{ k}\Omega$, $V_{COOUT} = 15\text{-pF}$ Load, VCO INHIBIT = GND, and PFD INHIBIT = GND.

PFD section

PARAMETER	TEST CONDITIONS	MIN	TYP	MAX	UNIT	
V_{OH}	High level output voltage	$I_{OH} = -2\text{ mA}$	4.5		V	
V_{OL}	Low level output voltage	$I_{OL} = 2\text{ mA}$		0.2	V	
I_{OZ}	High impedance state output current	PFD inhibit = high, $V_O = V_{DD}$ or GND		± 1	μA	
V_{IH}	High level input voltage at Fin-A, Fin-B		4.5		V	
V_{IL}	Low level input voltage at Fin-A, Fin-B			1	V	
V_{TH}	Input threshold voltage at PFD inhibit		1.5	2.5	3.5	V
C_{IN}	Input capacitance at Fin-A, Fin-B		5.6		pF	
Z_{IN}	Input impedance at Fin-A, Fin-B		10		M(Ω)	
$I_{DD}(Z)$	High impedance state PFD supply current	See Note 18		1	μA	
$I_{DD}(\text{PFD})$	PFD supply current	See Note 19	0.5	3	mA	

NOTES: 18. The current into LOGIC V_{DD} when FIN-A and FIN-B = ground, PFD INHIBIT = V_{DD} , PFD OUT open, and VCO OUT is inhibited.

19. The current into LOGIC V_{DD} when FIN-A = 1 MHz and FIN-B = 1 MHz ($V_{I(PP)} = 5\text{ V}$, rectangular wave), PFD INHIBIT = GND, PFD OUT open, and VCO OUT is inhibited



operation characteristics, $V_{DD} = 5\text{ V}$, $T_A = 25^\circ\text{C}$ (unless otherwise noted)

VCO section

PARAMETER		TEST CONDITIONS	MIN	TYP	MAX	UNIT
f_{OSC}	Operation oscillation frequency	$R_{BIAS} = 3.3\text{ k}\Omega$, $V_{CO\ IN} = 1/2\ V_{DD}$	37	57	75	MHz
f_{STB}	Time to stable oscillation (see Note 20)				10	us
t_r	Rise time	$C_L = 15\text{ pF}$		7.5	10	ns
t_f	Fall time	$C_L = 15\text{ pF}$		6.4	10	ns
f_{DUTY}	Duty cycle at VCO OUT	$R_{BIAS} = 3.3\text{ k}\Omega$, $V_{CO\ IN} = 1/2\ V_{DD}$	45%	50%	55%	
$\alpha (f_{OSC})$	Temperature coefficient of oscillation frequency	$V_{CO\ IN} = 1/2\ V_{DD}$, $T_A = -20^\circ\text{C}$ to 75°C		-0.346		%/ $^\circ\text{C}$
$k_{SVS}(f_{OSC})$	Supply voltage coefficient of oscillation frequency	$V_{CO\ IN} = 1/2\ V_{DD}$, $V_{DD} = 4.75\text{ V}$ to 5.25 V		0.002		%/mV
	Jitter absolute (see Note 21)	PLL jitter, $N = 128$		145		ps

NOTES: 20. The time period to the stable VCO oscillation frequency after the VCO INHIBIT terminal is changed to a low level.

21. Jitter performance is highly dependent on circuit layout and external device characteristics. The jitter specification was made with a carefully deigned PCB with no device socket.

PFD section

PARAMETER		TEST CONDITIONS	MIN	TYP	MAX	UNIT
f_{max}	Maximum operation frequency		38			MHz
t_{PLZ}	PFD output disable time from low level			20	40	ns
t_{PHZ}	PFD output disable time from high level			20	40	ns
t_{PZL}	PFD output enable time to low level			4	20	ns
t_{PZH}	PFD output enable time to high level			4.3	20	ns
t_r	Rise time	$C_L = 15\text{ pF}$		2.1	10	ns
t_f	Fall time	$C_L = 15\text{ pF}$		1.3	10	ns

TLC2932A HIGH PERFORMANCE PHASE LOCKED LOOP

SLES150 – OCTOBER 2005

PARAMETER MEASUREMENT INFORMATION

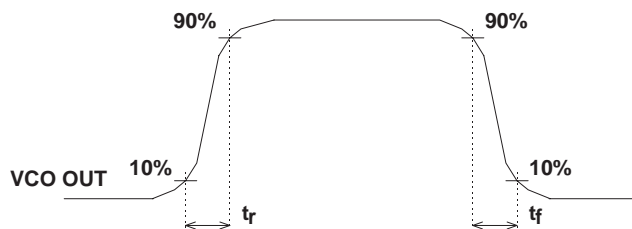

Figure 3. VCO Output Voltage Waveform

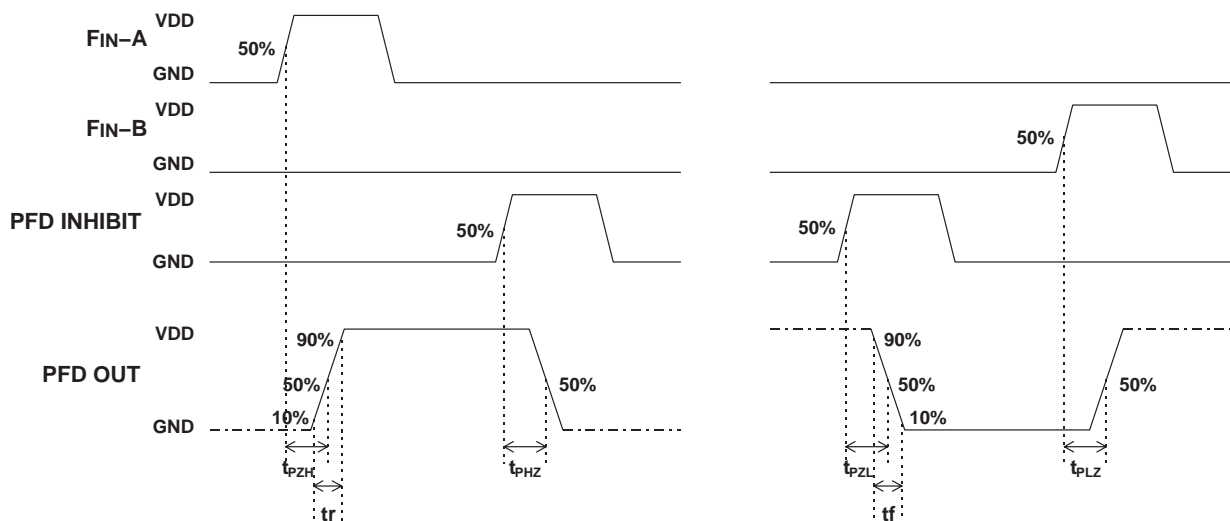

Figure 4. PFD Output Voltage Waveform

Table 4. PFD Output Test Conditions

PARAMETER	R_L	C_L	S1	S2
t_{pZH}	1 k Ω	15 pF	OPEN	CLOSE
t_{pHZ}				
t_r				
t_{pZL}			CLOSE	OPEN
t_{pLZ}				
t_f				

PARAMETER MEASUREMENT INFORMATION

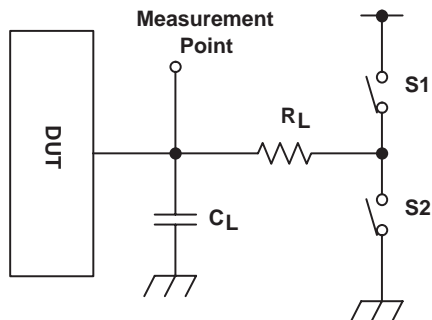

Figure 5. PFD Output Test Conditions

TYPICAL CHARACTERISTICS

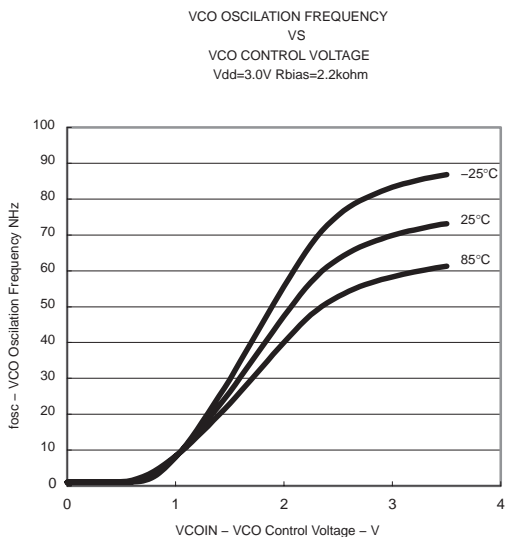

Figure 6.

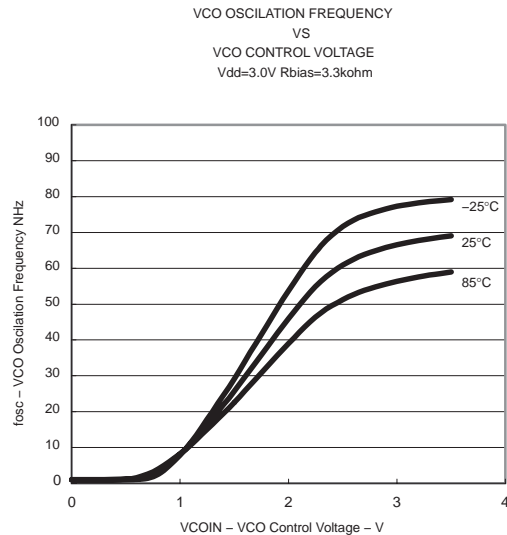

Figure 7.

TLC2932A HIGH PERFORMANCE PHASE LOCKED LOOP

SLES150 – OCTOBER 2005

TYPICAL CHARACTERISTICS

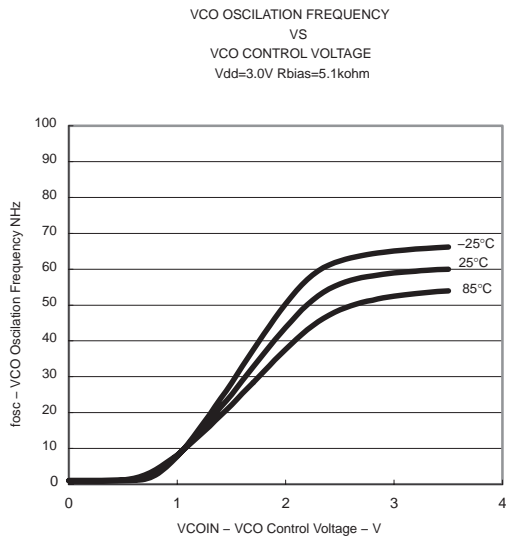

Figure 8.

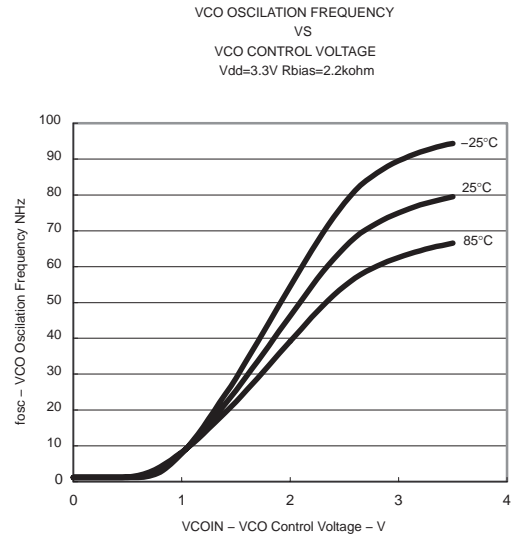

Figure 9.

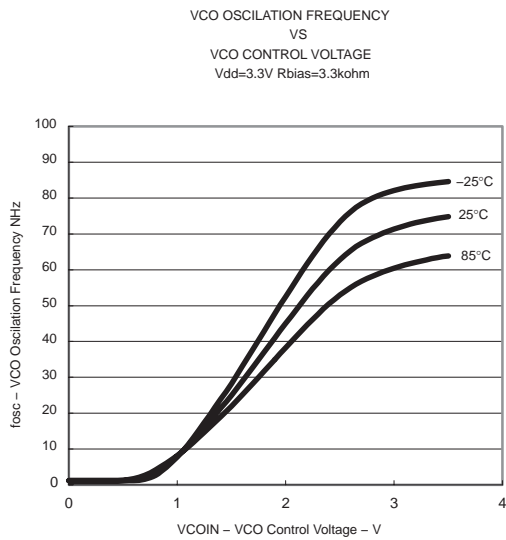

Figure 10.

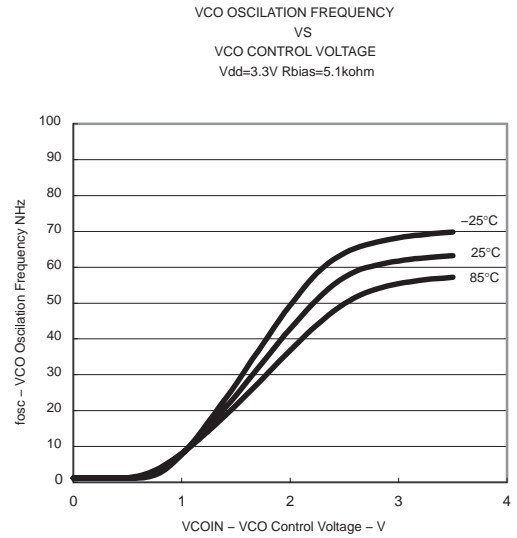

Figure 11.

TYPICAL CHARACTERISTICS

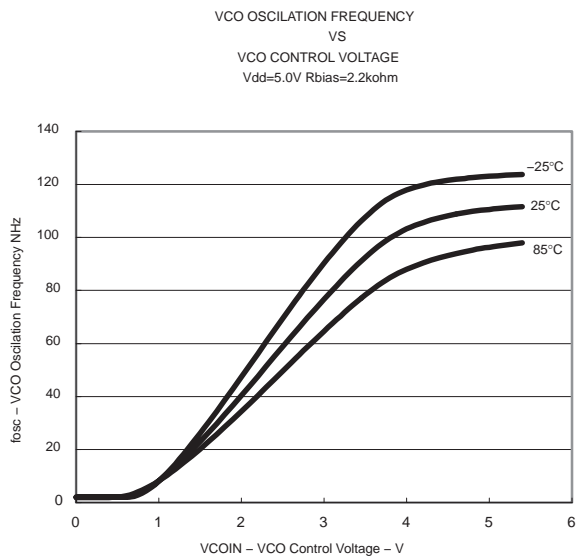

Figure 12.

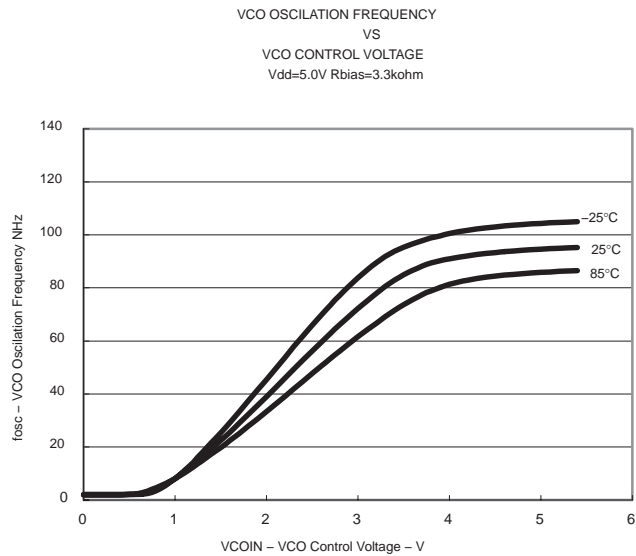

Figure 13.

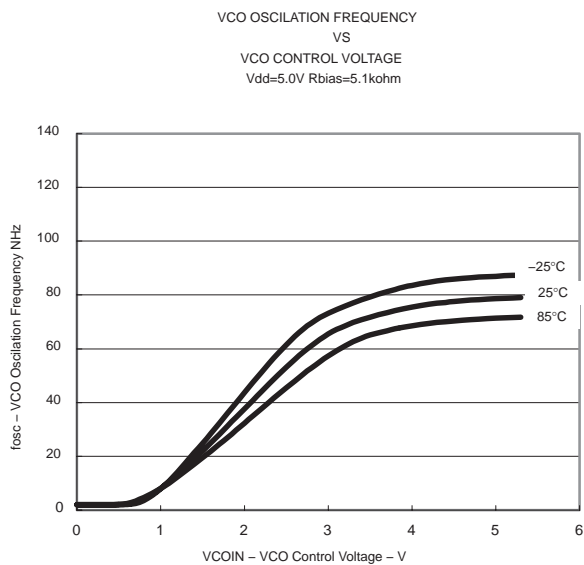

Figure 14.

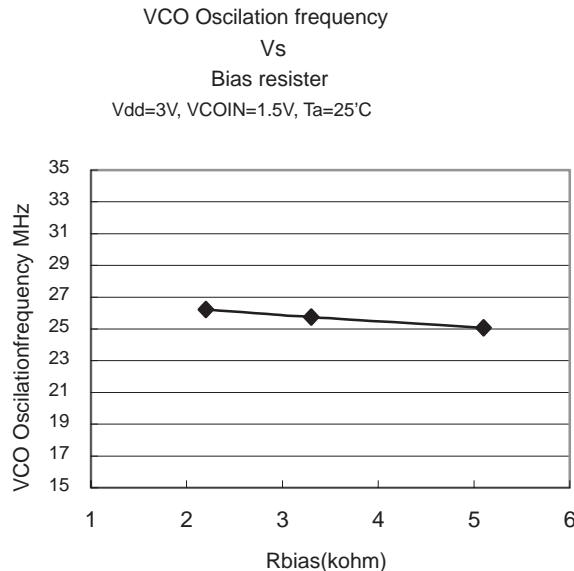

Figure 15.

TLC2932A HIGH PERFORMANCE PHASE LOCKED LOOP

SLES150 – OCTOBER 2005

TYPICAL CHARACTERISTICS

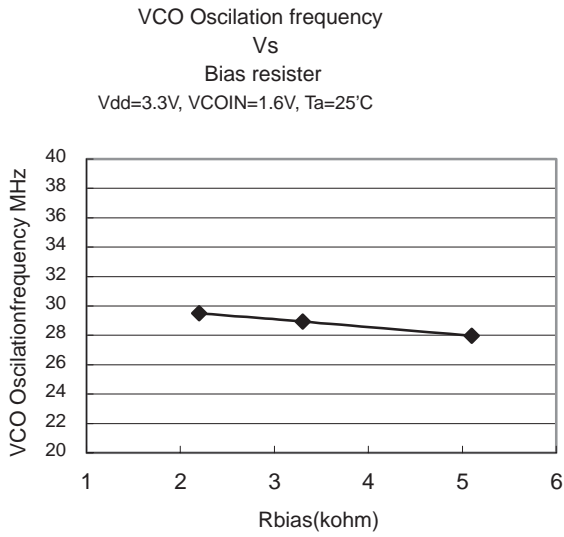

Figure 16.

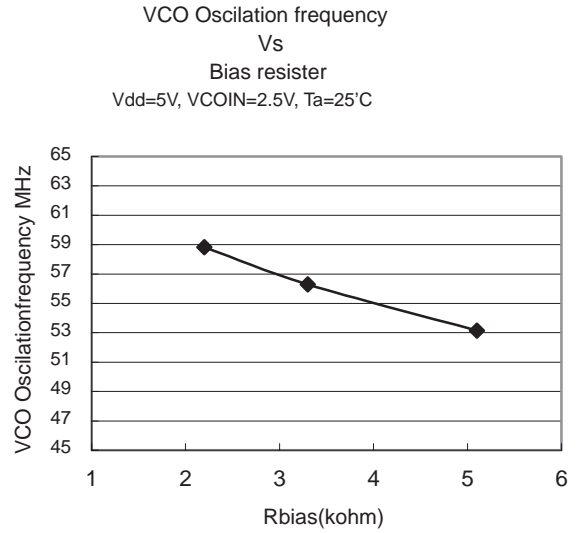

Figure 17.

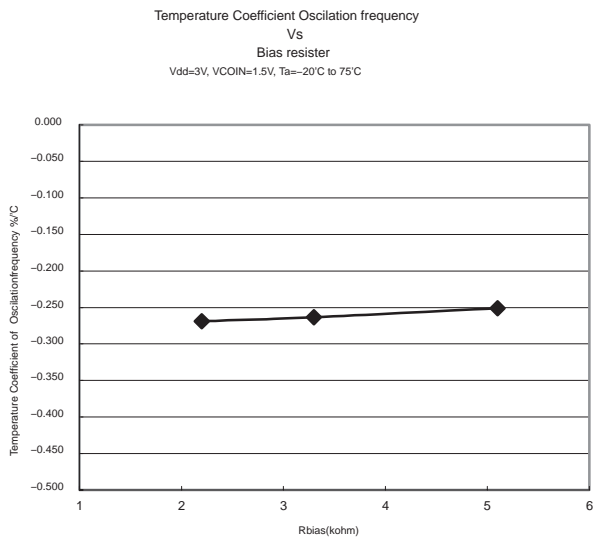

Figure 18.

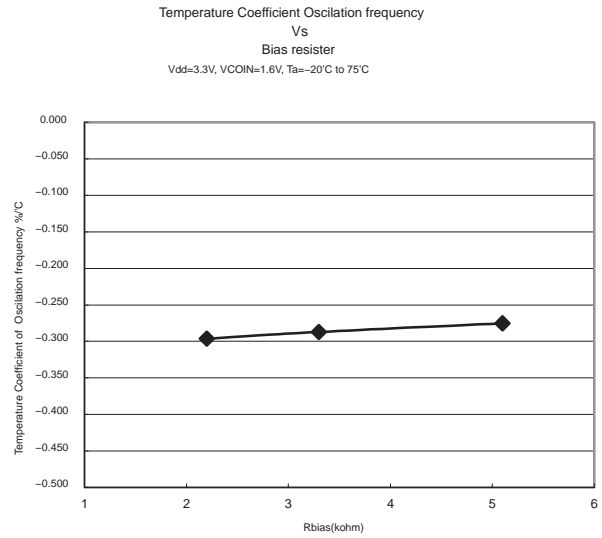

Figure 19.

TYPICAL CHARACTERISTICS

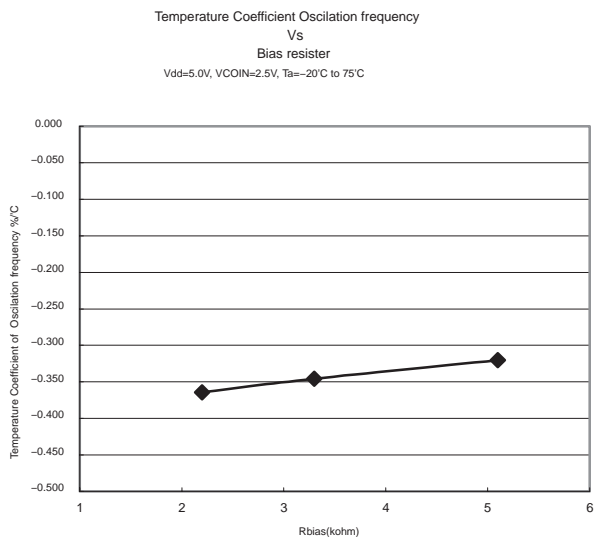

Figure 20.

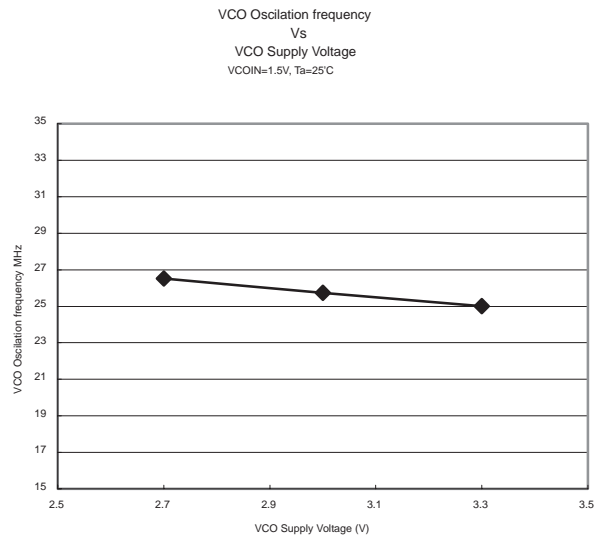

Figure 21.

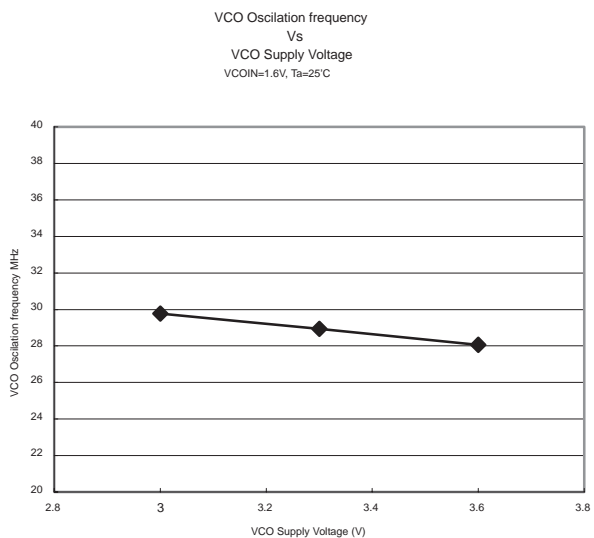

Figure 22.

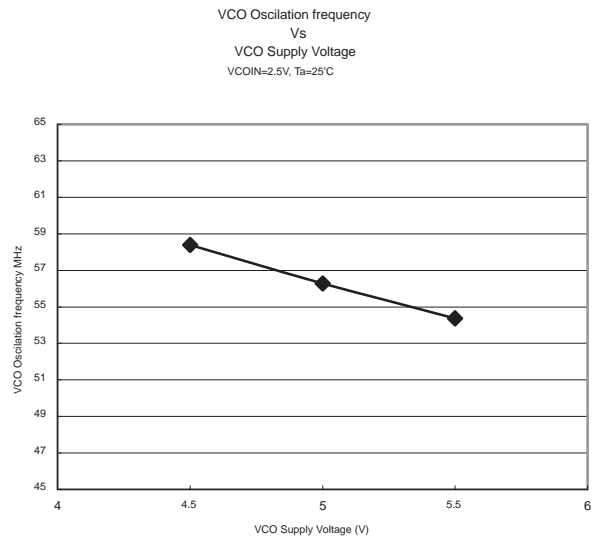

Figure 23.

TLC2932A HIGH PERFORMANCE PHASE LOCKED LOOP

SLES150 – OCTOBER 2005

TYPICAL CHARACTERISTICS

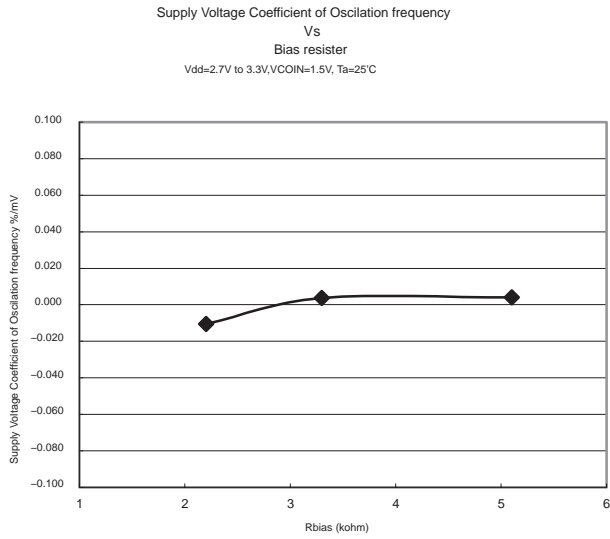

Figure 24.

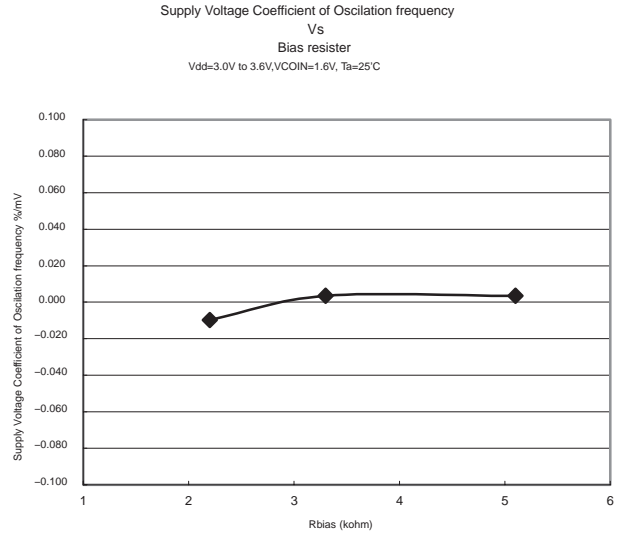

Figure 25.

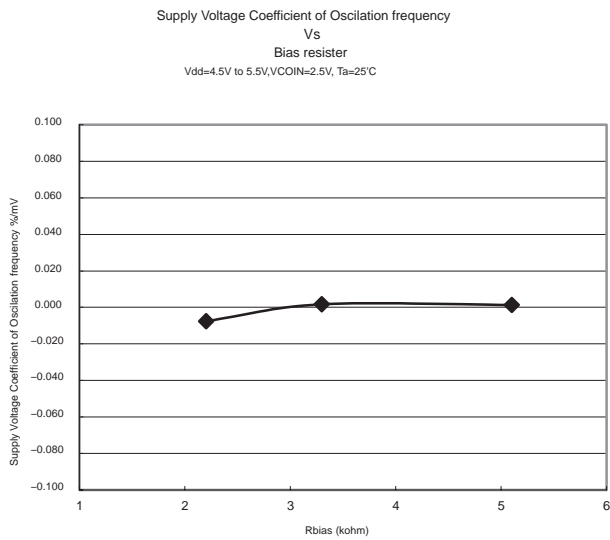

Figure 26.

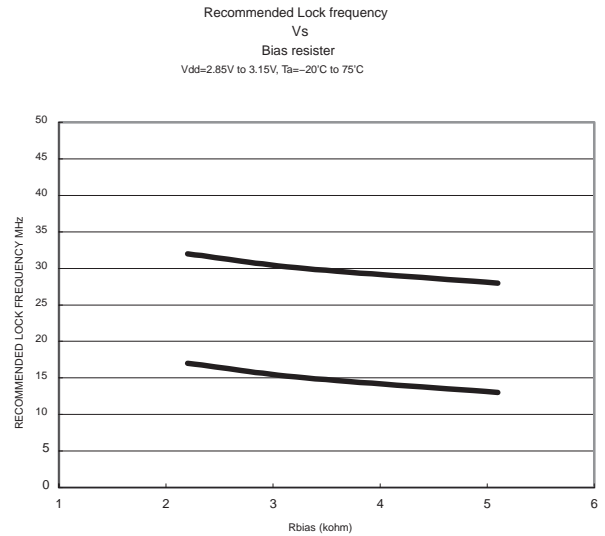

Figure 27.

TYPICAL CHARACTERISTICS

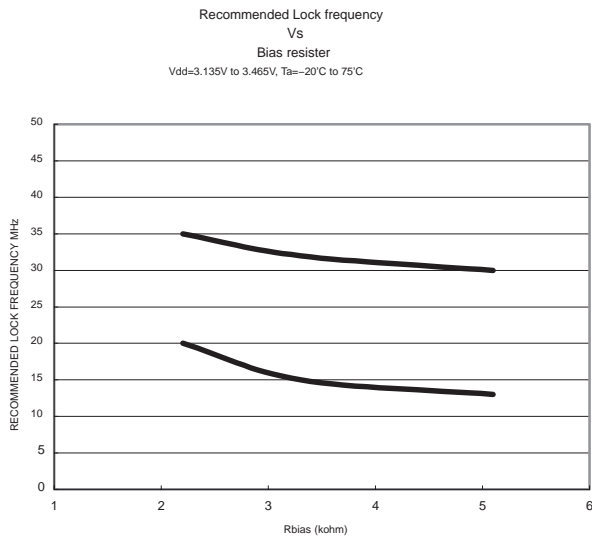

Figure 28.

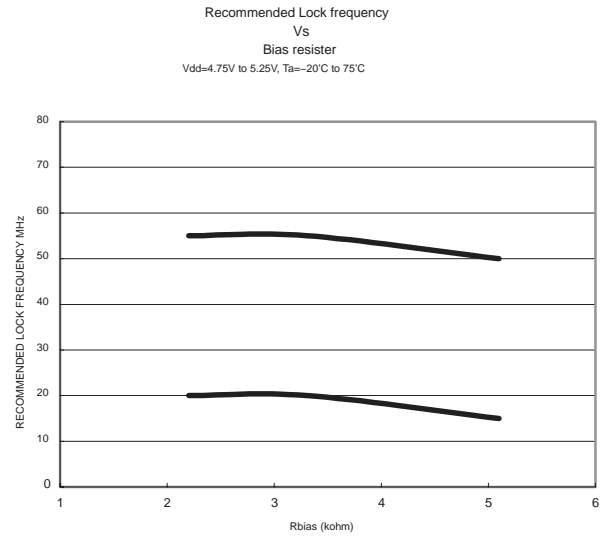

Figure 29.

PW (R-PDSO-G**)

PLASTIC SMALL-OUTLINE PACKAGE

14 PINS SHOWN



4040064/F 01/97

- NOTES: A. All linear dimensions are in millimeters.
 B. This drawing is subject to change without notice.
 C. Body dimensions do not include mold flash or protrusion not to exceed 0,15.
 D. Falls within JEDEC MO-153

IMPORTANT NOTICE

Texas Instruments Incorporated and its subsidiaries (TI) reserve the right to make corrections, modifications, enhancements, improvements, and other changes to its products and services at any time and to discontinue any product or service without notice. Customers should obtain the latest relevant information before placing orders and should verify that such information is current and complete. All products are sold subject to TI's terms and conditions of sale supplied at the time of order acknowledgment.

TI warrants performance of its hardware products to the specifications applicable at the time of sale in accordance with TI's standard warranty. Testing and other quality control techniques are used to the extent TI deems necessary to support this warranty. Except where mandated by government requirements, testing of all parameters of each product is not necessarily performed.

TI assumes no liability for applications assistance or customer product design. Customers are responsible for their products and applications using TI components. To minimize the risks associated with customer products and applications, customers should provide adequate design and operating safeguards.

TI does not warrant or represent that any license, either express or implied, is granted under any TI patent right, copyright, mask work right, or other TI intellectual property right relating to any combination, machine, or process in which TI products or services are used. Information published by TI regarding third-party products or services does not constitute a license from TI to use such products or services or a warranty or endorsement thereof. Use of such information may require a license from a third party under the patents or other intellectual property of the third party, or a license from TI under the patents or other intellectual property of TI.

Reproduction of TI information in TI data books or data sheets is permissible only if reproduction is without alteration and is accompanied by all associated warranties, conditions, limitations, and notices. Reproduction of this information with alteration is an unfair and deceptive business practice. TI is not responsible or liable for such altered documentation. Information of third parties may be subject to additional restrictions.

Resale of TI products or services with statements different from or beyond the parameters stated by TI for that product or service voids all express and any implied warranties for the associated TI product or service and is an unfair and deceptive business practice. TI is not responsible or liable for any such statements.

TI products are not authorized for use in safety-critical applications (such as life support) where a failure of the TI product would reasonably be expected to cause severe personal injury or death, unless officers of the parties have executed an agreement specifically governing such use. Buyers represent that they have all necessary expertise in the safety and regulatory ramifications of their applications, and acknowledge and agree that they are solely responsible for all legal, regulatory and safety-related requirements concerning their products and any use of TI products in such safety-critical applications, notwithstanding any applications-related information or support that may be provided by TI. Further, Buyers must fully indemnify TI and its representatives against any damages arising out of the use of TI products in such safety-critical applications.

TI products are neither designed nor intended for use in military/aerospace applications or environments unless the TI products are specifically designated by TI as military-grade or "enhanced plastic." Only products designated by TI as military-grade meet military specifications. Buyers acknowledge and agree that any such use of TI products which TI has not designated as military-grade is solely at the Buyer's risk, and that they are solely responsible for compliance with all legal and regulatory requirements in connection with such use.

TI products are neither designed nor intended for use in automotive applications or environments unless the specific TI products are designated by TI as compliant with ISO/TS 16949 requirements. Buyers acknowledge and agree that, if they use any non-designated products in automotive applications, TI will not be responsible for any failure to meet such requirements.

Following are URLs where you can obtain information on other Texas Instruments products and application solutions:

Products

Amplifiers	amplifier.ti.com
Data Converters	dataconverter.ti.com
DSP	dsp.ti.com
Clocks and Timers	www.ti.com/clocks
Interface	interface.ti.com
Logic	logic.ti.com
Power Mgmt	power.ti.com
Microcontrollers	microcontroller.ti.com
RFID	www.ti-rfid.com
RF/IF and ZigBee® Solutions	www.ti.com/lprf

Applications

Audio	www.ti.com/audio
Automotive	www.ti.com/automotive
Broadband	www.ti.com/broadband
Digital Control	www.ti.com/digitalcontrol
Medical	www.ti.com/medical
Military	www.ti.com/military
Optical Networking	www.ti.com/opticalnetwork
Security	www.ti.com/security
Telephony	www.ti.com/telephony
Video & Imaging	www.ti.com/video
Wireless	www.ti.com/wireless

Mailing Address: Texas Instruments, Post Office Box 655303, Dallas, Texas 75265
Copyright © 2008, Texas Instruments Incorporated