

# TLC227x, TLC227xA Advanced LinCMOS™ RAIL-TO-RAIL OPERATIONAL AMPLIFIERS

SLOS190G – FEBRUARY 1997 – REVISED MAY 2004

- Output Swing Includes Both Supply Rails
- Low Noise . . . 9 nV/√Hz Typ at f = 1 kHz
- Low Input Bias Current . . . 1 pA Typ
- Fully Specified for Both Single-Supply and Split-Supply Operation
- Common-Mode Input Voltage Range Includes Negative Rail
- High-Gain Bandwidth . . . 2.2 MHz Typ
- High Slew Rate . . . 3.6 V/μs Typ
- Low Input Offset Voltage  
950 μV Max at T<sub>A</sub> = 25°C
- Macromodel Included
- Performance Upgrades for the TS272, TS274, TLC272, and TLC274
- Available in Q-Temp Automotive HighRel Automotive Applications Configuration Control / Print Support Qualification to Automotive Standards

## description

The TLC2272 and TLC2274 are dual and quadruple operational amplifiers from Texas Instruments. Both devices exhibit rail-to-rail output performance for increased dynamic range in single- or split-supply applications. The TLC227x family offers 2 MHz of bandwidth and 3 V/μs of slew rate for higher speed applications. These devices offer comparable ac performance while having better noise, input offset voltage, and power dissipation than existing CMOS operational amplifiers. The TLC227x has a noise voltage of 9 nV/√Hz, two times lower than competitive solutions.

The TLC227x, exhibiting high input impedance and low noise, is excellent for small-signal conditioning for high-impedance sources, such as piezoelectric transducers. Because of the micro-power dissipation levels, these devices work well in hand-held monitoring and remote-sensing applications. In addition, the rail-to-rail output feature, with single- or split-supplies, makes this family a great choice when interfacing with analog-to-digital converters (ADCs). For precision applications, the TLC227xA family is available with a maximum input offset voltage of 950 μV. This family is fully characterized at 5 V and ±5 V.

The TLC2272/4 also makes great upgrades to the TLC272/4 or TS272/4 in standard designs. They offer increased output dynamic range, lower noise voltage, and lower input offset voltage. This enhanced feature set allows them to be used in a wider range of applications. For applications that require higher output drive and wider input voltage range, see the TLV2432 and TLV2442 devices.

If the design requires single amplifiers, see the TLV2211/21/31 family. These devices are single rail-to-rail operational amplifiers in the SOT-23 package. Their small size and low power consumption, make them ideal for high density, battery-powered equipment.

MAXIMUM PEAK-TO-PEAK OUTPUT VOLTAGE  
VS  
SUPPLY VOLTAGE

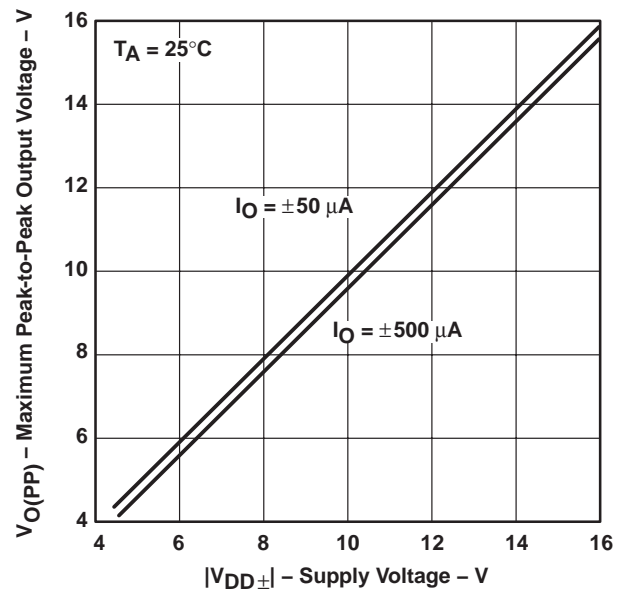

Please be aware that an important notice concerning availability, standard warranty, and use in critical applications of Texas Instruments semiconductor products and disclaimers thereto appears at the end of this data sheet.

Advanced LinCMOS is a trademark of Texas Instruments.

PRODUCTION DATA information is current as of publication date. Products conform to specifications per the terms of Texas Instruments standard warranty. Production processing does not necessarily include testing of all parameters.

 **TEXAS  
INSTRUMENTS**

POST OFFICE BOX 655303 • DALLAS, TEXAS 75265

Copyright © 2004, Texas Instruments Incorporated  
On products compliant to MIL-PRF-38535, all parameters are tested unless otherwise noted. On all other products, production processing does not necessarily include testing of all parameters.

# TLC227x, TLC227xA Advanced LinCMOS™ RAIL-TO-RAIL OPERATIONAL AMPLIFIERS

SLOS190G – FEBRUARY 1997 – REVISED MAY 2004

## TLC2272 AVAILABLE OPTIONS

T <sub>A</sub>	V <sub>IOMAX</sub> At 25°C	PACKAGED DEVICES					
		SMALL OUTLINE† (D)	CERAMIC LCC (FK)	CERAMIC DIP (JG)	PLASTIC DIP (P)	TSSOP‡ (PW)	CERAMIC FLAT PACK (U)
0°C to 70°C	950 μV 2.5 mV	TLC2272ACD TLC2272CD	— —	— —	TLC2272ACP TLC2272CP	TLC2272ACPW TLC2272CPW	— —
-40°C to 125°C	950 μV 2.5 mV	TLC2272AID TLC2272ID	— —	— —	TLC2272AIP TLC2272IP	— TLC2272IPW	— —
	950 μV 2.5 mV	TLC2272AQD TLC2272QD	— —	— —	—	TLC2272AQPW TLC2272QPW	— —
-55°C to 125°C	950 μV 2.5 mV	TLC2272AMD TLC2272MD	TLC2272AMFK TLC2272MFK	TLC2272AMJG TLC2272MJG	TLC2272AMP TLC2272MP	—	TLC2272AMU TLC2272MU

† The D packages are available taped and reeled. Add R suffix to the device type (e.g., TLC2272CDR).

‡ The PW package is available taped and reeled. Add R suffix to the device type (e.g., TLC2272PWR).

§ Chips are tested at 25°C.

## TLC2274 AVAILABLE OPTIONS

T <sub>A</sub>	V <sub>IOMAX</sub> AT 25°C	PACKAGED DEVICES					
		SMALL OUTLINE† (D)	CERAMIC LCC (FK)	CERAMIC DIP (J)	PLASTIC DIP (N)	TSSOP‡ (PW)	CERAMIC FLAT PACK (W)
0°C to 70°C	950 μV 2.5 mV	TLC2274ACD TLC2274CD	—	—	TLC2274ACN TLC2274CN	TLC2274ACPW TLC2274CPW	—
-40°C to 125°C	950 μV 2.5 mV	TLC2274AID TLC2274ID	—	—	TLC2274AIN TLC2274IN	TLC2274AIPW TLC2274IPW	—
	950 μV 2.5 mV	TLC2274AQD TLC2274QD	—	—	—	—	—
-55°C to 125°C	950 μV 2.5 mV	TLC2274AMD TLC2274MD	TLC2274AMFK TLC2274MFK	TLC2274AMJ TLC2274MJ	TLC2274AMN TLC2274MN	—	TLC2274AMW TLC2274MW

† The D packages are available taped and reeled. Add R suffix to device type (e.g., TLC2274CDR).

‡ The PW package is available taped and reeled.

§ Chips are tested at 25°C.



# TLC227x, TLC227xA Advanced LinCMOS™ RAIL-TO-RAIL OPERATIONAL AMPLIFIERS

SLOS190G – FEBRUARY 1997 – REVISED MAY 2004

equivalent schematic (each amplifier)

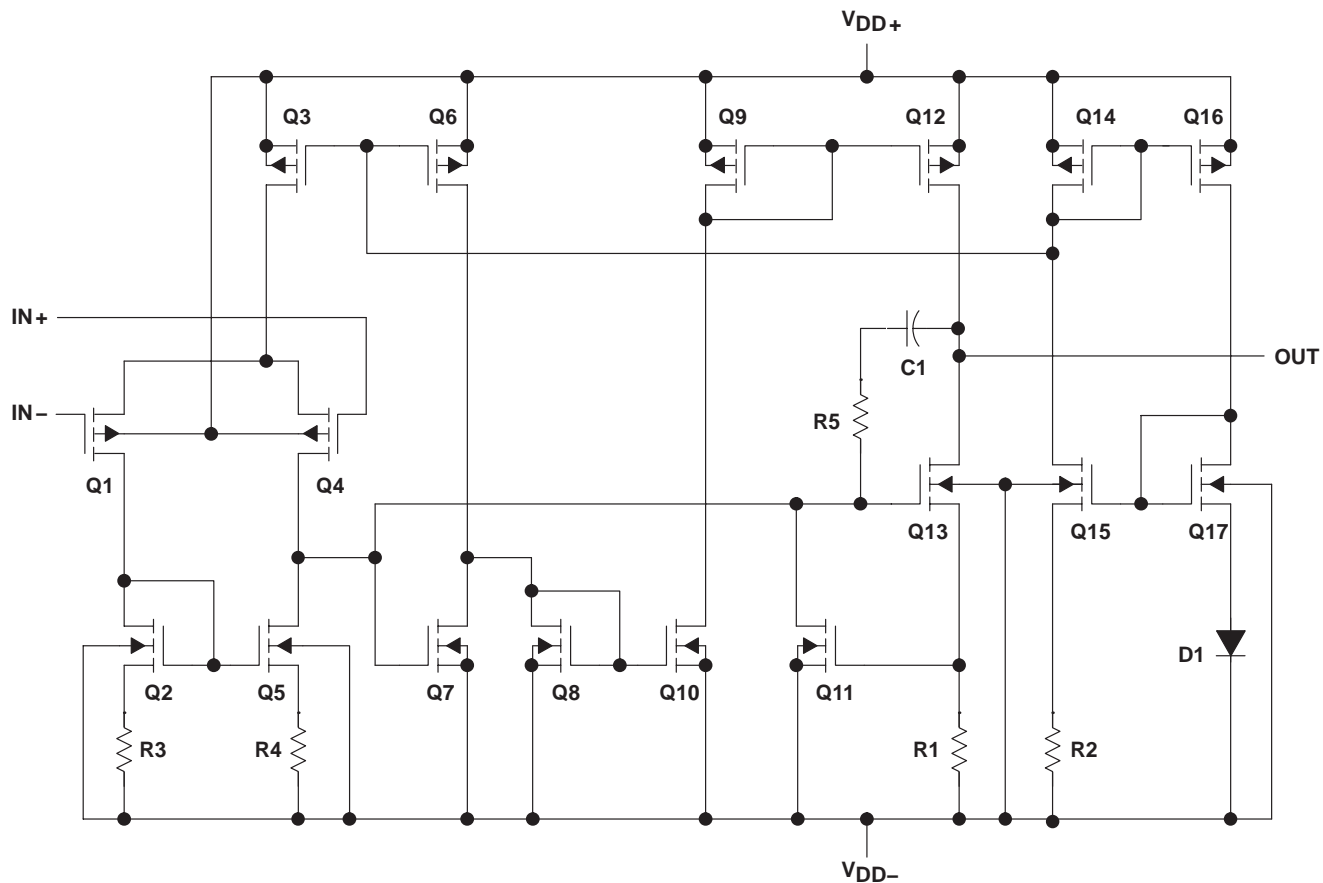

ACTUAL DEVICE COMPONENT COUNT†		
COMPONENT	TLC2272	TLC2274
Transistors	38	76
Resistors	26	52
Diodes	9	18
Capacitors	3	6

† Includes both amplifiers and all ESD, bias, and trim circuitry

**absolute maximum ratings over operating free-air temperature range (unless otherwise noted)†**

Supply voltage, $V_{DD+}$ (see Note 1)	8 V
Supply voltage, $V_{DD-}$ (see Note 1)	–8 V
Differential input voltage, $V_{ID}$ (see Note 2)	±16 V
Input voltage range, $V_I$ (any input, see Note 1)	$V_{DD-} - 0.3\text{ V}$ to $V_{DD+}$
Input current, $I_I$ (any input)	±5 mA
Output current, $I_O$	±50 mA
Total current into $V_{DD+}$	±50 mA
Total current out of $V_{DD-}$	±50 mA
Duration of short-circuit current at (or below) 25°C (see Note 3)	unlimited
Package thermal impedance, $\theta_{JA}$ (see Notes 4 and 5):	
D package (8 pin)	97.1°C/W
D package (14 pin)	86.2°C/W
N package	79.7°C/W
P package	84.6°C/W
PW package (8 pin)	149°C/W
PW package (14 pin)	113°C/W
Package thermal impedance, $\theta_{JC}$ (see Notes 4 and 5):	
FK package	5.6°C/W
J package	15.1°C/W
U package	14.7°C/W
Operating free-air temperature range, $T_A$ :	
C suffix	0°C to 70°C
I, Q suffix	–40°C to 125°C
M suffix	–55°C to 125°C
Storage temperature range	–65°C to 150°C
Lead temperature 1,6 mm (1/16 inch) from case for 10 seconds: D, N, P or PW package	260°C
Lead temperature 1,6 mm (1/16 inch) from case for 60 seconds: J or U package	300°C

† Stresses beyond those listed under “absolute maximum ratings” may cause permanent damage to the device. These are stress ratings only, and functional operation of the device at these or any other conditions beyond those indicated under “recommended operating conditions” is not implied. Exposure to absolute-maximum-rated conditions for extended periods may affect device reliability.

- NOTES:
1. All voltage values, except differential voltages, are with respect to the midpoint between  $V_{DD+}$  and  $V_{DD-}$ .
  2. Differential voltages are at  $IN+$  with respect to  $IN-$ . Excessive current will flow if input is brought below  $V_{DD-} - 0.3\text{ V}$ .
  3. The output may be shorted to either supply. Temperature and/or supply voltages must be limited to ensure that the maximum dissipation rating is not exceeded.
  4. Maximum power dissipation is a function of  $T_J(\text{max})$ ,  $\theta_{JA}$ , and  $T_A$ . The maximum allowable power dissipation at any allowable ambient temperature is  $P_D = (T_J(\text{max}) - T_A)/\theta_{JA}$ . Operating at the absolute maximum  $T_J$  of 150°C can affect reliability.
  5. The package thermal impedance is calculated in accordance with JESD 51-7 (plastic) or MIL-STD-883 Method 1012 (ceramic).

**recommended operating conditions**

	C SUFFIX		I SUFFIX		Q SUFFIX		M SUFFIX		UNIT
	MIN	MAX	MIN	MAX	MIN	MAX	MIN	MAX	
Supply voltage, $V_{DD\pm}$	±2.2	±8	±2.2	±8	±2.2	±8	±2.2	±8	V
Input voltage, $V_I$	$V_{DD-}$	$V_{DD+} - 1.5$	$V_{DD-}$	$V_{DD+} - 1.5$	$V_{DD-}$	$V_{DD+} - 1.5$	$V_{DD-}$	$V_{DD+} - 1.5$	V
Common-mode input voltage, $V_{IC}$	$V_{DD-}$	$V_{DD+} - 1.5$	$V_{DD-}$	$V_{DD+} - 1.5$	$V_{DD-}$	$V_{DD+} - 1.5$	$V_{DD-}$	$V_{DD+} - 1.5$	V
Operating free-air temperature, $T_A$	0	70	–40	125	–40	125	–55	125	°C

# TLC227x, TLC227xA Advanced LinCMOS™ RAIL-TO-RAIL OPERATIONAL AMPLIFIERS

SLOS190G – FEBRUARY 1997 – REVISED MAY 2004

**TLC2272C electrical characteristics at specified free-air temperature,  $V_{DD} = 5\text{ V}$  (unless otherwise noted)**

PARAMETER	TEST CONDITIONS	$T_A$ †	TLC2272C			TLC2272AC			UNIT
			MIN	TYP	MAX	MIN	TYP	MAX	
$V_{IO}$ Input offset voltage	$V_{IC} = 0\text{ V}$ , $V_{DD} \pm \pm 2.5\text{ V}$ , $V_O = 0\text{ V}$ , $R_S = 50\ \Omega$	25°C	300	2500		300	950	$\mu\text{V}$	
		Full range			3000		1500		
$\alpha_{VIO}$ Temperature coefficient of input offset voltage		25°C to 70°C	2			2		$\mu\text{V}/^\circ\text{C}$	
Input offset voltage long-term drift (see Note 4)		25°C	0.002			0.002		$\mu\text{V}/\text{mo}$	
$I_{IO}$ Input offset current		25°C	0.5	60		0.5	60	$\text{pA}$	
		Full range			100		100		
$I_{IB}$ Input bias current		25°C	1	60		1	60	$\text{pA}$	
		Full range			100		100		
$V_{ICR}$ Common-mode input voltage	$R_S = 50\ \Omega$ , $ V_{IO}  \leq 5\text{ mV}$	25°C	0 to 4	-0.3 to 4.2		0 to 4	-0.3 to 4.2	$\text{V}$	
		Full range	0 to 3.5			0 to 3.5			
$V_{OH}$ High-level output voltage	$I_{OH} = -20\ \mu\text{A}$	25°C		4.99			4.99	$\text{V}$	
		25°C	4.85	4.93		4.85	4.93		
		Full range	4.85			4.85			
		25°C	4.25	4.65		4.25	4.65		
$V_{OL}$ Low-level output voltage	$I_{OL} = 50\ \mu\text{A}$	25°C		0.01			0.01	$\text{V}$	
		25°C	0.09	0.15		0.09	0.15		
		Full range			0.15		0.15		
		25°C	0.9	1.5		0.9	1.5		
$V_{OL}$ Low-level output voltage	$I_{OL} = 500\ \mu\text{A}$	25°C		0.01			0.01	$\text{V}$	
		25°C	0.09	0.15		0.09	0.15		
		Full range			0.15		0.15		
		25°C	0.9	1.5		0.9	1.5		
$V_{OL}$ Low-level output voltage	$I_{OL} = 5\text{ mA}$	25°C		0.01			0.01	$\text{V}$	
		25°C	0.09	0.15		0.09	0.15		
		Full range			0.15		0.15		
		25°C	0.9	1.5		0.9	1.5		
$A_{VD}$ Large-signal differential voltage amplification	$V_{IC} = 2.5\text{ V}$ , $V_O = 1\text{ V to }4\text{ V}$	$R_L = 10\text{ k}\Omega^\ddagger$	25°C	15	35		15	35	$\text{V}/\text{mV}$
			Full range	15			15		
			25°C		175			175	
$A_{VD}$ Large-signal differential voltage amplification	$V_{IC} = 2.5\text{ V}$ , $V_O = 1\text{ V to }4\text{ V}$	$R_L = 1\text{ m}\Omega^\ddagger$	25°C		175			175	$\text{V}/\text{mV}$
			Full range			175			
			25°C		175			175	
$r_{id}$ Differential input resistance		25°C		$10^{12}$			$10^{12}$	$\Omega$	
$r_i$ Common-mode input resistance		25°C		$10^{12}$			$10^{12}$	$\Omega$	
$c_i$ Common-mode input capacitance	$f = 10\text{ kHz}$ , P package	25°C		8			8	$\text{pF}$	
$z_o$ Closed-loop output impedance	$f = 1\text{ MHz}$ , $A_V = 10$	25°C		140			140	$\Omega$	
CMRR Common-mode rejection ratio	$V_{IC} = 0\text{ V to }2.7\text{ V}$ , $V_O = 2.5\text{ V}$ , $R_S = 50\ \Omega$	25°C	70	75		70	75	$\text{dB}$	
		Full range	70			70			
$k_{SVR}$ Supply-voltage rejection ratio ( $\Delta V_{DD}/\Delta V_{IO}$ )	$V_{DD} = 4.4\text{ V to }16\text{ V}$ , $V_{IC} = V_{DD}/2$ , No load	25°C	80	95		80	95	$\text{dB}$	
		Full range	80			80			
$I_{DD}$ Supply current	$V_O = 2.5\text{ V}$ , No load	25°C		2.2	3		2.2	3	$\text{mA}$
		Full range			3		3		

† Full range is 0°C to 70°C.

‡ Referenced to 0 V

NOTE 6: Typical values are based on the input offset voltage shift observed through 168 hours of operating life test at  $T_A = 150^\circ\text{C}$  extrapolated to  $T_A = 25^\circ\text{C}$  using the Arrhenius equation and assuming an activation energy of 0.96 eV.



**TLC227x, TLC227xA**  
**Advanced LinCMOS™ RAIL-TO-RAIL**  
**OPERATIONAL AMPLIFIERS**

SLOS190G – FEBRUARY 1997 – REVISED MAY 2004

**TLC2272C operating characteristics at specified free-air temperature,  $V_{DD} = 5\text{ V}$**

PARAMETER	TEST CONDITIONS	$T_A$ †	TLC2272C			TLC2272AC			UNIT
			MIN	TYP	MAX	MIN	TYP	MAX	
SR	Slew rate at unity gain $V_O = 0.5\text{ V to }2.5\text{ V}$ , $R_L = 10\text{ k}\Omega$ ‡, $C_L = 100\text{ pF}$ ‡	25°C	2.3	3.6		2.3	3.6	V/ $\mu\text{s}$	
		Full range	1.7			1.7			
$V_n$	Equivalent input noise voltage $f = 10\text{ Hz}$ $f = 1\text{ kHz}$	25°C		50			50	nV/ $\sqrt{\text{Hz}}$	
		25°C		9			9		
$V_{NPP}$	Peak-to-peak equivalent input noise voltage $f = 0.1\text{ Hz to }1\text{ Hz}$ $f = 0.1\text{ Hz to }10\text{ Hz}$	25°C		1			1	$\mu\text{V}$	
		25°C		1.4			1.4		
$I_n$	Equivalent input noise current	25°C		0.6			0.6	fA/ $\sqrt{\text{Hz}}$	
THD + N	Total harmonic distortion plus noise $V_O = 0.5\text{ V to }2.5\text{ V}$ , $f = 20\text{ kHz}$ , $R_L = 10\text{ k}\Omega$ ‡	25°C		$A_V = 1$	0.0013%		0.0013%		
				$A_V = 10$	0.004%		0.004%		
				$A_V = 100$	0.03%		0.03%		
	Gain-bandwidth product $f = 10\text{ kHz}$ , $R_L = 10\text{ k}\Omega$ ‡, $C_L = 100\text{ pF}$ ‡	25°C		2.18			2.18	MHz	
$B_{OM}$	Maximum output-swing bandwidth $V_{O(PP)} = 2\text{ V}$ , $A_V = 1$ , $R_L = 10\text{ k}\Omega$ ‡, $C_L = 100\text{ pF}$ ‡	25°C		1			1	MHz	
$t_s$	Settling time $A_V = -1$ , Step = 0.5 V to 2.5 V, $R_L = 10\text{ k}\Omega$ ‡, $C_L = 100\text{ pF}$ ‡	25°C		To 0.1%	1.5		1.5	$\mu\text{s}$	
				To 0.01%	2.6		2.6		
$\phi_m$	Phase margin at unity gain $R_L = 10\text{ k}\Omega$ ‡, $C_L = 100\text{ pF}$ ‡	25°C		50°			50°		
		25°C		10			10		dB

† Full range is 0°C to 70°C.

‡ Referenced to 0 V

# TLC227x, TLC227xA Advanced LinCMOS™ RAIL-TO-RAIL OPERATIONAL AMPLIFIERS

SLOS190G – FEBRUARY 1997 – REVISED MAY 2004

**TLC2272C electrical characteristics at specified free-air temperature,  $V_{DD\pm} = \pm 5\text{ V}$  (unless otherwise specified)**

PARAMETER	TEST CONDITIONS	$T_A$ †	TLC2272C			TLC2272AC			UNIT
			MIN	TYP	MAX	MIN	TYP	MAX	
$V_{IO}$ Input offset voltage	$V_{IC} = 0\text{ V}, R_S = 50\ \Omega, V_O = 0\text{ V},$	25°C	300	2500		300	950	$\mu\text{V}$	
		Full range			3000		1500		
$\alpha_{VIO}$ Temperature coefficient of input offset voltage		25°C to 70°C	2			2			$\mu\text{V}/^\circ\text{C}$
Input offset voltage long-term drift (see Note 4)		25°C	0.002			0.002			$\mu\text{V}/\text{mo}$
$I_{IO}$ Input offset current		25°C	0.5	60		0.5	60	$\text{pA}$	
		Full range			100		100		
$I_{IB}$ Input bias current	25°C	1			1			$\text{pA}$	
	Full range			100		100			
$V_{ICR}$ Common-mode input voltage	$R_S = 50\ \Omega,  V_{IO}  \leq 5\text{ mV}$	25°C	-5 to 4	-5.3 to 4.2		-5 to 4	-5.3 to 4.2	$\text{V}$	
		Full range	-5 to 3.5			-5 to 3.5			
$V_{OM+}$ Maximum positive peak output voltage	$I_O = -20\ \mu\text{A}$	25°C	4.99			4.99			$\text{V}$
		25°C	4.85	4.93		4.85	4.93		
	Full range	4.85			4.85				
	$I_O = -1\text{ mA}$	25°C	4.25	4.65		4.25	4.65		
Full range		4.25			4.25				
$V_{OM-}$ Maximum negative peak output voltage	$V_{IC} = 0\text{ V}, I_O = 50\ \mu\text{A}$	25°C	-4.99			-4.99			$\text{V}$
		25°C	-4.85	-4.91		-4.85	-4.91		
	Full range	-4.85			-4.85				
	$V_{IC} = 0\text{ V}, I_O = 5\text{ mA}$	25°C	-3.5	-4.1		-3.5	-4.1		
Full range		-3.5			-3.5				
$AVD$ Large-signal differential voltage amplification	$V_O = \pm 4\text{ V}$	$R_L = 10\text{ k}\Omega$	25°C	25	50		25	50	$\text{V}/\text{mV}$
			Full range	25			25		
		$R_L = 1\text{ m}\Omega$	25°C	300			300		
$r_{id}$ Differential input resistance		25°C	1012			1012			$\Omega$
$r_i$ Common-mode input resistance		25°C	1012			1012			$\Omega$
$c_i$ Common-mode input capacitance	$f = 10\text{ kHz}, \text{ P package}$	25°C	8			8			$\text{pF}$
$z_o$ Closed-loop output impedance	$f = 1\text{ MHz}, A_V = 10$	25°C	130			130			$\Omega$
CMRR Common-mode rejection ratio	$V_{IC} = -5\text{ V to } 2.7\text{ V}, V_O = 0\text{ V}, R_S = 50\ \Omega$	25°C	75	80		75	80	$\text{dB}$	
		Full range	75			75			
$k_{SVR}$ Supply-voltage rejection ratio ( $\Delta V_{DD\pm} / \Delta V_{IO}$ )	$V_{DD\pm} = 2.2\text{ V to } \pm 8\text{ V}, V_{IC} = 0\text{ V}, \text{ No load}$	25°C	80	95		80	95	$\text{dB}$	
		Full range	80			80			
$I_{DD}$ Supply current	$V_O = 0\text{ V}, \text{ No load}$	25°C	2.4			2.4			$\text{mA}$
		Full range			3		3		

† Full range is 0°C to 70°C.

NOTE 4: Typical values are based on the input offset voltage shift observed through 168 hours of operating life test at  $T_A = 150^\circ\text{C}$  extrapolated to  $T_A = 25^\circ\text{C}$  using the Arrhenius equation and assuming an activation energy of 0.96 eV.



**TLC227x, TLC227xA**  
**Advanced LinCMOS™ RAIL-TO-RAIL**  
**OPERATIONAL AMPLIFIERS**

SLOS190G – FEBRUARY 1997 – REVISED MAY 2004

**TLC2272C operating characteristics at specified free-air temperature,  $V_{DD\pm} = \pm 5\text{ V}$**

PARAMETER	TEST CONDITIONS	$T_A$ †	TLC2272C			TLC2272AC			UNIT
			MIN	TYP	MAX	MIN	TYP	MAX	
SR	Slew rate at unity gain $V_O = \pm 2.3\text{ V}$ , $C_L = 100\text{ pF}$ $R_L = 10\text{ k}\Omega$	25°C	2.3	3.6		2.3	3.6		V/ $\mu\text{s}$
		Full range	1.7			1.7			
$V_n$	Equivalent input noise voltage	f = 10 Hz		50			50		nV/ $\sqrt{\text{Hz}}$
		f = 1 kHz	25°C		9		9		
$V_{NPP}$	Peak-to-peak equivalent input noise voltage	f = 0.1 Hz to 1 Hz	25°C		1		1		$\mu\text{V}$
		f = 0.1 Hz to 10 Hz	25°C		1.4		1.4		
$I_n$	Equivalent input noise current		25°C		0.6		0.6		fA/ $\sqrt{\text{Hz}}$
THD + N	Total harmonic distortion pulse duration $V_O = \pm 2.3\text{ V}$ , f = 20 kHz, $R_L = 10\text{ k}\Omega$	$A_V = 1$	25°C		0.0011%		0.0011%		
		$A_V = 10$			0.004%		0.004%		
		$A_V = 100$			0.03%		0.03%		
	Gain-bandwidth product	f = 10 kHz, $C_L = 100\text{ pF}$ $R_L = 10\text{ k}\Omega$	25°C		2.25		2.25		MHz
BOM	Maximum output-swing bandwidth	$V_{O(PP)} = 4.6\text{ V}$ , $R_L = 10\text{ k}\Omega$ , $A_V = 1$ , $C_L = 100\text{ pF}$	25°C		0.54		0.54		MHz
$t_s$	Settling time	$A_V = -1$ , Step = $-2.3\text{ V}$ to $2.3\text{ V}$ , $R_L = 10\text{ k}\Omega$ , $C_L = 100\text{ pF}$	To 0.1%	25°C		1.5		1.5	$\mu\text{s}$
			To 0.01%			3.2		3.2	
$\phi_m$	Phase margin at unity gain	$R_L = 10\text{ k}\Omega$ , $C_L = 100\text{ pF}$	25°C		52°		52°		
	Gain margin		25°C		10		10	dB	

† Full range is 0°C to 70°C.

# TLC227x, TLC227xA Advanced LinCMOS™ RAIL-TO-RAIL OPERATIONAL AMPLIFIERS

SLOS190G – FEBRUARY 1997 – REVISED MAY 2004

**TLC2274C electrical characteristics at specified free-air temperature,  $V_{DD} = 5\text{ V}$  (unless otherwise noted)**

PARAMETER	TEST CONDITIONS	$T_A$ †	TLC2274C			TLC2274AC			UNIT
			MIN	TYP	MAX	MIN	TYP	MAX	
$V_{IO}$ Input offset voltage	$V_{DD\pm} = \pm 2.5\text{ V}$ , $V_O = 0\text{ V}$ , $V_{IC} = 0\text{ V}$ , $R_S = 50\ \Omega$	25°C	300	2500		300	950	$\mu\text{V}$	
		Full range			3000		1500		
$\alpha_{VIO}$ Temperature coefficient of input offset voltage		25°C to 70°C	2			2			$\mu\text{V}/^\circ\text{C}$
Input offset voltage long-term drift (see Note 4)		25°C	0.002			0.002			$\mu\text{V}/\text{mo}$
$I_{IO}$ Input offset current		25°C	0.5	60		0.5	60	$\text{pA}$	
		Full range			100		100		
$I_{IB}$ Input bias current		25°C	1	60		1	60	$\text{pA}$	
		Full range			100		100		
$V_{ICR}$ Common-mode input voltage	$R_S = 50\ \Omega$ , $ V_{IO}  \leq 5\text{ mV}$	25°C	0 to 4	-0.3 to 4.2		0 to 4	-0.3 to 4.2	V	
		Full range	0 to 3.5			0 to 3.5			
$V_{OH}$ High-level output voltage	$I_{OH} = -20\ \mu\text{A}$	25°C	4.99		4.99		V		
		25°C	4.85	4.93	4.85	4.93			
		Full range	4.85		4.85				
		25°C	4.25	4.65	4.25	4.65			
$V_{OL}$ Low-level output voltage	$I_{OH} = -1\text{ mA}$	25°C	0.01		0.01		V		
		25°C	0.09	0.15	0.09	0.15			
		Full range	0.15		0.15				
		25°C	0.9	1.5	0.9	1.5			
$V_{OL}$ Low-level output voltage	$V_{IC} = 2.5\text{ V}$ , $I_{OL} = 50\ \mu\text{A}$	25°C	0.01		0.01		V		
		25°C	0.09	0.15	0.09	0.15			
		Full range	0.15		0.15				
		25°C	0.9	1.5	0.9	1.5			
$V_{OL}$ Low-level output voltage	$V_{IC} = 2.5\text{ V}$ , $I_{OL} = 500\ \mu\text{A}$	25°C	0.01		0.01		V		
		25°C	0.09	0.15	0.09	0.15			
		Full range	0.15		0.15				
		25°C	0.9	1.5	0.9	1.5			
$V_{OL}$ Low-level output voltage	$V_{IC} = 2.5\text{ V}$ , $I_{OL} = 5\text{ mA}$	25°C	0.01		0.01		V		
		25°C	0.09	0.15	0.09	0.15			
		Full range	0.15		0.15				
$A_{VD}$ Large-signal differential voltage amplification	$V_{IC} = 2.5\text{ V}$ , $V_O = 1\text{ V to }4\text{ V}$	$R_L = 10\text{ k}\Omega$ ‡	25°C	15	35	15	35	V/mV	
			Full range	15		15			
			$R_L = 1\text{ m}\Omega$ ‡	25°C	175				175
Full range	175			175					
$r_{id}$ Differential input resistance		25°C	$10^{12}$			$10^{12}$			$\Omega$
$r_i$ Common-mode input resistance		25°C	$10^{12}$			$10^{12}$			$\Omega$
$c_i$ Common-mode input capacitance	$f = 10\text{ kHz}$ , N package	25°C	8			8			pF
$z_o$ Closed-loop output impedance	$f = 1\text{ MHz}$ , $A_V = 10$	25°C	140			140			$\Omega$
CMRR Common-mode rejection ratio	$V_{IC} = 0\text{ V to }2.7\text{ V}$ , $V_O = 2.5\text{ V}$ , $R_S = 50\ \Omega$	25°C	70	75		70	75	dB	
		Full range	70			70			
$k_{SVR}$ Supply-voltage rejection ratio ( $\Delta V_{DD}/\Delta V_{IO}$ )	$V_{DD} = 4.4\text{ V to }16\text{ V}$ , $V_{IC} = V_{DD}/2$ , No load	25°C	80	95		80	95	dB	
		Full range	80			80			
$I_{DD}$ Supply current	$V_O = 2.5\text{ V}$ , No load	25°C	4.4	6		4.4	6	mA	
		Full range	6			6			

† Full range is 0°C to 70°C.

‡ Referenced to 0 V

NOTE 4: Typical values are based on the input offset voltage shift observed through 168 hours of operating life test at  $T_A = 150^\circ\text{C}$  extrapolated to  $T_A = 25^\circ\text{C}$  using the Arrhenius equation and assuming an activation energy of 0.96 eV.



**TLC227x, TLC227xA**  
**Advanced LinCMOS™ RAIL-TO-RAIL**  
**OPERATIONAL AMPLIFIERS**

SLOS190G – FEBRUARY 1997 – REVISED MAY 2004

**TLC2274C operating characteristics at specified free-air temperature,  $V_{DD} = 5\text{ V}$**

PARAMETER	TEST CONDITIONS	$T_A$ †	TLC2274C			TLC2274AC			UNIT	
			MIN	TYP	MAX	MIN	TYP	MAX		
SR	Slew rate at unity gain $V_O = 0.5\text{ V to }2.5\text{ V}$ , $R_L = 10\text{ k}\Omega$ ‡, $C_L = 100\text{ pF}$ ‡	25°C	2.3	3.6		2.3	3.6		V/ $\mu\text{s}$	
		Full range	1.7			1.7				
$V_n$	Equivalent input noise voltage $f = 10\text{ Hz}$ $f = 1\text{ kHz}$	25°C		50			50		nV/ $\sqrt{\text{Hz}}$	
		25°C		9			9			
$V_{N(PP)}$	Peak-to-peak equivalent input noise voltage $f = 0.1\text{ Hz to }1\text{ Hz}$ $f = 0.1\text{ Hz to }10\text{ Hz}$	25°C		1			1		$\mu\text{V}$	
		25°C		1.4			1.4			
$I_n$	Equivalent input noise current	25°C		0.6			0.6		fA/ $\sqrt{\text{Hz}}$	
THD + N	Total harmonic distortion plus noise $V_O = 0.5\text{ V to }2.5\text{ V}$ , $f = 20\text{ kHz}$ , $R_L = 10\text{ k}\Omega$ ‡	$A_V = 1$	25°C	0.0013%			0.0013%			
		$A_V = 10$		0.004%			0.004%			
		$A_V = 100$		0.03%			0.03%			
	Gain-bandwidth product $f = 10\text{ kHz}$ , $C_L = 100\text{ pF}$ ‡	$R_L = 10\text{ k}\Omega$ ‡, 25°C		2.18			2.18			MHz
BOM	Maximum output-swing bandwidth $V_{O(PP)} = 2\text{ V}$ , $R_L = 10\text{ k}\Omega$ ‡, $A_V = 1$ , $C_L = 100\text{ pF}$ ‡	25°C		1			1			MHz
$t_s$	Settling time $A_V = -1$ , Step = 0.5 V to 2.5 V, $R_L = 10\text{ k}\Omega$ ‡, $C_L = 100\text{ pF}$ ‡	To 0.1%	25°C	1.5			1.5			$\mu\text{s}$
		To 0.01%		2.6			2.6			
$\phi_m$	Phase margin at unity gain $R_L = 10\text{ k}\Omega$ ‡, $C_L = 100\text{ pF}$ ‡	25°C		50°			50°			
		25°C		10			10			

† Full range is 0°C to 70°C.

‡ Referenced to 0 V

**TLC227x, TLC227xA**  
**Advanced LinCMOS™ RAIL-TO-RAIL**  
**OPERATIONAL AMPLIFIERS**

SLOS190G – FEBRUARY 1997 – REVISED MAY 2004

**TLC2274C electrical characteristics at specified free-air temperature,  $V_{DD\pm} = \pm 5\text{ V}$  (unless otherwise noted)**

PARAMETER	TEST CONDITIONS	$T_A$ †	TLC2274C			TLC2274AC			UNIT
			MIN	TYP	MAX	MIN	TYP	MAX	
$V_{IO}$ Input offset voltage	$V_{IC} = 0\text{ V}, V_O = 0\text{ V}, R_S = 50\ \Omega$	25°C	300	2500		300	950	$\mu\text{V}$	
		Full range			3000		1500		
$\alpha V_{IO}$ Temperature coefficient of input offset voltage		25°C to 70°C	2			2			$\mu\text{V}/^\circ\text{C}$
Input offset voltage long-term drift (see Note 4)		25°C	0.002			0.002			$\mu\text{V}/\text{mo}$
$I_{IO}$ Input offset current		25°C	0.5	60		0.5	60	pA	
		Full range		100		100			
$I_{IB}$ Input bias current	25°C	1	60		1	60	pA		
	Full range		100		100				
$V_{ICR}$ Common-mode input voltage	$R_S = 50\ \Omega,  V_{IO}  \leq 5\text{ mV}$	25°C	-5 to 4	-5.3 to 4.2		-5 to 4	-5.3 to 4.2	V	
		Full range	-5 to 3.5			-5 to 3.5			
$V_{OM+}$ Maximum positive peak output voltage	$I_O = -20\ \mu\text{A}$	25°C	4.99		4.99		V		
		25°C	4.85	4.93	4.85	4.93			
		Full range	4.85		4.85				
		25°C	4.25	4.65	4.25	4.65			
$V_{OM-}$ Maximum negative peak output voltage	$I_O = -1\text{ mA}$	25°C	-4.99		-4.99		V		
		25°C	-4.85	-4.91	-4.85	-4.91			
		Full range	-4.85		-4.85				
		25°C	-3.5	-4.1	-3.5	-4.1			
$V_{IC-}$ Maximum negative peak output voltage	$V_{IC} = 0\text{ V}, I_O = 500\ \mu\text{A}$	25°C	-4.85	-4.91	-4.85	-4.91	V		
		Full range	-4.85		-4.85				
		25°C	-3.5	-4.1	-3.5	-4.1			
		Full range	-3.5		-3.5				
$A_{VD}$ Large-signal differential voltage amplification	$V_O = \pm 4\text{ V}$	$R_L = 10\text{ k}\Omega$	25°C	25	50	25	50	V/mV	
			Full range	25		25			
		$R_L = 1\text{ M}\Omega$	25°C	300		300			
$r_{id}$ Differential input resistance		25°C	$10^{12}$		$10^{12}$		$\Omega$		
$r_i$ Common-mode input resistance		25°C	$10^{12}$		$10^{12}$		$\Omega$		
$c_i$ Common-mode input capacitance	$f = 10\text{ kHz}, \text{ N package}$	25°C	8		8		pF		
$z_o$ Closed-loop output impedance	$f = 1\text{ MHz}, A_V = 10$	25°C	130		130		$\Omega$		
CMRR Common-mode rejection ratio	$V_{IC} = -5\text{ V to } 2.7\text{ V}, V_O = 0\text{ V}, R_S = 50\ \Omega$	25°C	75	80	75	80	dB		
		Full range	75		75				
$k_{SVR}$ Supply-voltage rejection ratio ( $\Delta V_{DD\pm}/\Delta V_{IO}$ )	$V_{DD\pm} = \pm 2.2\text{ V to } \pm 8\text{ V}, V_{IC} = 0\text{ V}, \text{ No load}$	25°C	80	95	80	95	dB		
		Full range	80		80				
$I_{DD}$ Supply current	$V_O = 0\text{ V}, \text{ No load}$	25°C	4.8	6	4.8	6	mA		
		Full range	6		6				

† Full range is 0°C to 70°C.

NOTE 4: Typical values are based on the input offset voltage shift observed through 168 hours of operating life test at  $T_A = 150^\circ\text{C}$  extrapolated to  $T_A = 25^\circ\text{C}$  using the Arrhenius equation and assuming an activation energy of 0.96 eV.



**TLC227x, TLC227xA**  
**Advanced LinCMOS™ RAIL-TO-RAIL**  
**OPERATIONAL AMPLIFIERS**

SLOS190G – FEBRUARY 1997 – REVISED MAY 2004

**TLC2274C operating characteristics at specified free-air temperature,  $V_{DD\pm} = \pm 5\text{ V}$**

PARAMETER	TEST CONDITIONS	$T_A$ †	TLC2274C			TLC2274AC			UNIT
			MIN	TYP	MAX	MIN	TYP	MAX	
SR	Slew rate at unity gain $V_O = \pm 2.3\text{ V}$ , $C_L = 100\text{ pF}$ , $R_L = 10\text{ k}\Omega$	25°C	2.3	3.6		2.3	3.6		V/ $\mu\text{s}$
		Full range	1.7			1.7			
$V_n$	Equivalent input noise voltage	f = 10 Hz		50			50		nV/ $\sqrt{\text{Hz}}$
		f = 1 Hz	25°C		9		9		
$V_{N(PP)}$	Peak-to-peak equivalent input noise voltage	f = 0.1 Hz to 1 Hz	25°C		1		1		$\mu\text{V}$
		f = 0.1 Hz to 10 Hz	25°C		1.4		1.4		
$I_n$	Equivalent input noise current	25°C		0.6		0.6		fA/ $\sqrt{\text{Hz}}$	
THD + N	Total harmonic distortion plus noise $V_O = \pm 2.3\text{ V}$ , f = 20 kHz, $R_L = 10\text{ k}\Omega$	$A_V = 1$	25°C		0.0011%		0.0011%		
		$A_V = 10$			0.004%		0.004%		
		$A_V = 100$			0.03%		0.03%		
	Gain-bandwidth product	f = 10 kHz, $C_L = 100\text{ pF}$ , $R_L = 10\text{ k}\Omega$	25°C		2.25		2.25	MHz	
BOM	Maximum output-swing bandwidth	$V_{O(PP)} = 4.6\text{ V}$ , $R_L = 10\text{ k}\Omega$ , $A_V = 1$ , $C_L = 100\text{ pF}$	25°C		0.54		0.54	MHz	
$t_s$	Settling time	$A_V = -1$ , Step = $-2.3\text{ V}$ to $2.3\text{ V}$ , $R_L = 10\text{ k}\Omega$ , $C_L = 100\text{ pF}$	To 0.1%	25°C		1.5		1.5	$\mu\text{s}$
			To 0.01%			3.2		3.2	
$\phi_m$	Phase margin at unity gain	$R_L = 10\text{ k}\Omega$ , $C_L = 100\text{ pF}$	25°C		52°		52°		
	Gain margin		25°C		10		10	dB	

† Full range is 0°C to 70°C.

# TLC227x, TLC227xA Advanced LinCMOS™ RAIL-TO-RAIL OPERATIONAL AMPLIFIERS

SLOS190G – FEBRUARY 1997 – REVISED MAY 2004

**TLC2272I electrical characteristics at specified free-air temperature,  $V_{DD} = 5\text{ V}$  (unless otherwise noted)**

PARAMETER	TEST CONDITIONS	$T_A$ †	TLC2272I			TLC2272AI			UNIT
			MIN	TYP	MAX	MIN	TYP	MAX	
$V_{IO}$ Input offset voltage		25°C	300	2500		300	950	$\mu\text{V}$	
		Full range			3000		1500		
$\alpha_{VIO}$ Temperature coefficient of input offset voltage		25°C to 85°C	2			2			$\mu\text{V}/^\circ\text{C}$
Input offset voltage long-term drift (see Note 4)	$V_{IC} = 0\text{ V},$ $V_O = 0\text{ V},$ $V_{DD\pm} = \pm 2.5\text{ V}$ $R_S = 50\ \Omega$	25°C	0.002			0.002			$\mu\text{V}/\text{mo}$
$I_{IO}$ Input offset current		25°C	0.5	60		0.5	60	pA	
	-40°C to 85°C	150			150				
	Full range	800			800				
$I_{IB}$ Input bias current	25°C	1	60		1	60	pA		
	-40°C to 85°C	150			150				
	Full range	800			800				
$V_{ICR}$ Common-mode input voltage	$R_S = 50\ \Omega,$ $ V_{IO}  \leq 5\text{ mV}$	25°C	0 to 4	-0.3 to 4.2		0 to 4	-0.3 to 4.2	V	
		Full range	0 to 3.5			0 to 3.5			
$V_{OH}$ High-level output voltage	$I_{OH} = -20\ \mu\text{A}$ $I_{OH} = -200\ \mu\text{A}$ $I_{OH} = -1\text{ mA}$	25°C	4.99			4.99			V
		25°C	4.85	4.93		4.85	4.93		
		Full range	4.85			4.85			
		25°C	4.25	4.65		4.25	4.65		
$V_{OL}$ Low-level output voltage	$V_{IC} = 2.5\text{ V},$ $I_{OL} = 50\ \mu\text{A}$ $V_{IC} = 2.5\text{ V},$ $I_{OL} = 500\ \mu\text{A}$ $V_{IC} = 2.5\text{ V},$ $I_{OL} = 5\text{ mA}$	25°C	0.01			0.01			V
		25°C	0.09	0.15		0.09	0.15		
		Full range	0.15			0.15			
		25°C	0.9	1.5		0.9	1.5		
$A_{VD}$ Large-signal differential voltage amplification	$V_{IC} = 2.5\text{ V},$ $V_O = 1\text{ V to }4\text{ V}$	$R_L = 10\text{ k}\Omega^\ddagger$	25°C	15	35		15	35	V/mV
			Full range	15			15		
		$R_L = 1\text{ m}\Omega^\ddagger$	25°C	175			175		
$r_{id}$ Differential input resistance		25°C	$10^{12}$			$10^{12}$			$\Omega$
$r_i$ Common-mode input resistance		25°C	$10^{12}$			$10^{12}$			$\Omega$
$C_i$ Common-mode input capacitance	$f = 10\text{ kHz},$ P package	25°C	8			8			pF
$Z_o$ Closed-loop output impedance	$f = 1\text{ MHz},$ $A_V = 10$	25°C	140			140			$\Omega$
CMRR Common-mode rejection ratio	$V_{IC} = 0\text{ V to }2.7\text{ V},$ $V_O = 2.5\text{ V},$ $R_S = 50\ \Omega$	25°C	70	75		70	75	dB	
		Full range	70			70			
$k_{SVR}$ Supply-voltage rejection ratio ( $\Delta V_{DD}/\Delta V_{IO}$ )	$V_{DD} = 4.4\text{ V to }16\text{ V},$ $V_{IC} = V_{DD}/2,$ No load	25°C	80	95		80	95	dB	
		Full range	80			80			
$I_{DD}$ Supply current	$V_O = 2.5\text{ V},$ No load	25°C	2.2	3		2.2	3	mA	
		Full range	3			3			

† Full range is -40°C to 125°C.

‡ Referenced to 0 V

NOTE 4: Typical values are based on the input offset voltage shift observed through 168 hours of operating life test at  $T_A = 150^\circ\text{C}$  extrapolated to  $T_A = 25^\circ\text{C}$  using the Arrhenius equation and assuming an activation energy of 0.96 eV.



**TLC227x, TLC227xA**  
**Advanced LinCMOS™ RAIL-TO-RAIL**  
**OPERATIONAL AMPLIFIERS**

SLOS190G – FEBRUARY 1997 – REVISED MAY 2004

**TLC2272I operating characteristics at specified free-air temperature,  $V_{DD} = 5\text{ V}$**

PARAMETER	TEST CONDITIONS	$T_A$ †	TLC2272I			TLC2272AI			UNIT
			MIN	TYP	MAX	MIN	TYP	MAX	
SR	Slew rate at unity gain $V_O = 0.5\text{ V to }2.5\text{ V}$ , $R_L = 10\text{ k}\Omega$ ‡, $C_L = 100\text{ pF}$ ‡	25°C	2.3	3.6		2.3	3.6		V/ $\mu\text{s}$
		Full range	1.7			1.7			
$V_n$	Equivalent input noise voltage	f = 10 Hz		50			50		nV $\sqrt{\text{Hz}}$
		f = 1 kHz	25°C		9		9		
$V_{NPP}$	Peak-to-peak equivalent input noise voltage	f = 0.1 Hz to 1 Hz	25°C		1		1		$\mu\text{V}$
		f = 0.1 Hz to 10 Hz	25°C		1.4		1.4		
$I_n$	Equivalent input noise current		25°C		0.6		0.6	fA $\sqrt{\text{Hz}}$	
THD + N	Total harmonic distortion plus noise f = 20 kHz, $R_L = 10\text{ k}\Omega$ ‡	$A_V = 1$	25°C		0.0013%		0.0013%		
		$A_V = 10$			0.004%		0.004%		
		$A_V = 100$			0.03%		0.03%		
	Gain-bandwidth product	f = 10 kHz, $R_L = 10\text{ k}\Omega$ ‡, $C_L = 100\text{ pF}$ ‡	25°C		2.18		2.18	MHz	
BOM	Maximum output-swing bandwidth	$V_{O(PP)} = 2\text{ V}$ , $R_L = 10\text{ k}\Omega$ ‡, $A_V = 1$ , $C_L = 100\text{ pF}$ ‡	25°C		1		1	MHz	
$t_s$	Settling time	$A_V = -1$ , Step = 0.5 V to 2.5 V, $R_L = 10\text{ k}\Omega$ ‡, $C_L = 100\text{ pF}$ ‡	To 0.1%	25°C		1.5		1.5	$\mu\text{s}$
			To 0.01%			2.6		2.6	
$\phi_m$	Phase margin at unity gain	$R_L = 10\text{ k}\Omega$ ‡, $C_L = 100\text{ pF}$ ‡	25°C		50°		50°		
	Gain margin		25°C		10		10	dB	

† Full range is – 40°C to 125°C.

‡ Referenced to 0 V

# TLC227x, TLC227xA

## Advanced LinCMOS™ RAIL-TO-RAIL OPERATIONAL AMPLIFIERS

SLOS190G – FEBRUARY 1997 – REVISED MAY 2004

TLC2272I electrical characteristics at specified free-air temperature,  $V_{DD\pm} = \pm 5\text{ V}$  (unless otherwise noted)

PARAMETER	TEST CONDITIONS		$T_A^\dagger$	TLC2272I			TLC2272AI			UNIT
				MIN	TYP	MAX	MIN	TYP	MAX	
$V_{IO}$ Input offset voltage			25°C	300 2500		300 950				$\mu\text{V}$
			Full range	3000		1500				
$\alpha_{VIO}$ Temperature coefficient of input offset voltage			25°C to 85°C	2		2				$\mu\text{V}/^\circ\text{C}$
Input offset voltage long-term drift (see Note 4)	$V_{IC} = 0\text{ V}, R_S = 50\ \Omega, V_O = 0\text{ V},$		25°C	0.002		0.002				$\mu\text{V}/\text{mo}$
$I_{IO}$ Input offset current			25°C	0.5	60	0.5	60			$\text{pA}$
			-40°C to 85°C	150		150				
			Full range	800		800				
$I_{IB}$ Input bias current			25°C	1	60	1	60			$\text{pA}$
			-40°C to 85°C	150		150				
			Full range	800		800				
$V_{ICR}$ Common-mode input voltage	$R_S = 50\ \Omega,  V_{IO}  \leq 5\text{ mV}$		25°C	-5 to 4	-5.3 to 4.2	-5 to 4	-5.3 to 4.2			$\text{V}$
			Full range	-5 to 3.5	-5 to 3.5	-5 to 3.5				
$V_{OM+}$ Maximum positive peak output voltage	$I_O = -20\ \mu\text{A}$		25°C	4.99		4.99				$\text{V}$
	$I_O = -200\ \mu\text{A}$		25°C	4.85	4.93	4.85	4.93			
	$I_O = -1\text{ mA}$		25°C	4.25	4.65	4.25	4.65			
			Full range	4.25		4.25				
$V_{OM-}$ Maximum negative peak output voltage	$V_{IC} = 0\text{ V}, I_O = 50\ \mu\text{A}$		25°C	-4.99		-4.99				$\text{V}$
	$V_{IC} = 0\text{ V}, I_O = 500\ \mu\text{A}$		25°C	-4.85	-4.91	-4.85	-4.91			
	$V_{IC} = 0\text{ V}, I_O = 5\text{ mA}$		25°C	-3.5	-4.1	-3.5	-4.1			
			Full range	-3.5		-3.5				
$A_{VD}$ Large-signal differential voltage amplification	$V_O = \pm 4\text{ V}$		$R_L = 10\text{ k}\Omega$		25°C	25	50	25	50	$\text{V}/\text{mV}$
					Full range		25		25	
			$R_L = 1\text{ m}\Omega$		25°C	300		300		
$r_{id}$ Differential input resistance			25°C	$10^{12}$		$10^{12}$				$\Omega$
$r_i$ Common-mode input resistance			25°C	$10^{12}$		$10^{12}$				$\Omega$
$c_i$ Common-mode input capacitance	$f = 10\text{ kHz},$	P package	25°C	8		8				$\text{pF}$
$z_o$ Closed-loop output impedance	$f = 1\text{ MHz},$	$A_V = 10$	25°C	130		130				$\Omega$
CMRR Common-mode rejection ratio	$V_{IC} = -5\text{ V to } 2.7\text{ V}, V_O = 0\text{ V}, R_S = 50\ \Omega$		25°C	75	80	75	80			$\text{dB}$
			Full range	75		75				
$k_{SVR}$ Supply-voltage rejection ratio ( $\Delta V_{DD\pm}/\Delta V_{IO}$ )	$V_{DD} = 4.4\text{ V to } 16\text{ V}, V_{IC} = V_{DD}/2, \text{ No load}$		25°C	80	95	80	95			$\text{dB}$
			Full range	80		80				
$I_{DD}$ Supply current	$V_O = 0\text{ V}, \text{ No load}$		25°C	2.4	3	2.4	3			$\text{mA}$
			Full range	3		3				

$^\dagger$  Full range is -40°C to 125°C.

NOTE 4: Typical values are based on the input offset voltage shift observed through 168 hours of operating life test at  $T_A = 150^\circ\text{C}$  extrapolated to  $T_A = 25^\circ\text{C}$  using the Arrhenius equation and assuming an activation energy of 0.96 eV.



**TLC227x, TLC227xA**  
**Advanced LinCMOS™ RAIL-TO-RAIL**  
**OPERATIONAL AMPLIFIERS**

SLOS190G – FEBRUARY 1997 – REVISED MAY 2004

**TLC2272I operating characteristics at specified free-air temperature,  $V_{DD\pm} = \pm 5\text{ V}$**

PARAMETER	TEST CONDITIONS	$T_A$ †	TLC2272I			TLC2272AI			UNIT
			MIN	TYP	MAX	MIN	TYP	MAX	
SR	Slew rate at unity gain $V_O = \pm 2.3\text{ V}$ , $C_L = 100\text{ pF}$ , $R_L = 10\text{ k}\Omega$	25°C	2.3	3.6		2.3	3.6		V/ $\mu\text{s}$
		Full range	1.7			1.7			
$V_n$	Equivalent input noise voltage $f = 10\text{ Hz}$ $f = 1\text{ kHz}$	25°C		50			50		nV/ $\sqrt{\text{Hz}}$
		25°C		9			9		
$V_{NPP}$	Peak-to-peak equivalent input noise voltage $f = 0.1\text{ Hz to }1\text{ Hz}$ $f = 0.1\text{ Hz to }10\text{ Hz}$	25°C		1			1		$\mu\text{V}$
		25°C		1.4			1.4		
$I_n$	Equivalent input noise current	25°C		0.6			0.6		fA/ $\sqrt{\text{Hz}}$
THD + N	Total harmonic distortion plus noise $V_O = \pm 2.3\text{ V}$ $R_L = 10\text{ k}\Omega$ , $f = 20\text{ kHz}$	25°C		$A_V = 1$	0.0011%		0.0011%		
				$A_V = 10$	0.004%		0.004%		
				$A_V = 100$	0.03%		0.03%		
	Gain-bandwidth product $f = 10\text{ kHz}$ , $C_L = 100\text{ pF}$ , $R_L = 10\text{ k}\Omega$	25°C		2.25			2.25		MHz
$B_{OM}$	Maximum output-swing bandwidth $V_{O(PP)} = 4.6\text{ V}$ , $R_L = 10\text{ k}\Omega$ , $A_V = 1$ , $C_L = 100\text{ pF}$	25°C		0.54			0.54		MHz
$t_s$	Settling time $A_V = -1$ , Step = $-2.3\text{ V to }2.3\text{ V}$ , $R_L = 10\text{ k}\Omega$ , $C_L = 100\text{ pF}$	25°C		To 0.1%	1.5		1.5		$\mu\text{s}$
				To 0.01%	3.2		3.2		
$\phi_m$	Phase margin at unity gain $R_L = 10\text{ k}\Omega$ , $C_L = 100\text{ pF}$	25°C		52°			52°		
		25°C		10			10		
	Gain margin	25°C		10			10		dB

† Full range is  $-40^\circ\text{C}$  to  $125^\circ\text{C}$ .

# TLC227x, TLC227xA Advanced LinCMOS™ RAIL-TO-RAIL OPERATIONAL AMPLIFIERS

SLOS190G – FEBRUARY 1997 – REVISED MAY 2004

**TLC2274I electrical characteristics at specified free-air temperature,  $V_{DD} = 5\text{ V}$  (unless otherwise noted)**

PARAMETER	TEST CONDITIONS	$T_A$ †	TLC2274I			TLC2274AI			UNIT
			MIN	TYP	MAX	MIN	TYP	MAX	
$V_{IO}$ Input offset voltage	$V_{DD\pm} = \pm 2.5\text{ V}$ , $V_{IC} = 0\text{ V}$ , $V_O = 0\text{ V}$ , $R_S = 50\ \Omega$	25°C	300	2500		300	950		$\mu\text{V}$
		Full range			3000		1500		
$\alpha_{VIO}$ Temperature coefficient of input offset voltage		25°C to 85°C	2			2			$\mu\text{V}/^\circ\text{C}$
Input offset voltage long-term drift (see Note 4)		25°C	0.002			0.002			$\mu\text{V}/\text{mo}$
$I_{IO}$ Input offset current		25°C	0.5	60		0.5	60		$\text{pA}$
		-40°C to 85°C	150			150			
		Full range	800			800			
$I_{IB}$ Input bias current		25°C	1	60		1	60		$\text{pA}$
	-40°C to 85°C	150			150				
	Full range	800			800				
$V_{ICR}$ Common-mode input voltage	$R_S = 50\ \Omega$ , $ V_{IO}  \leq 5\text{ mV}$	25°C	0 to 4	-0.3 to 4.2		0 to 4	-0.3 to 4.2		V
		Full range	0 to 3.5			0 to 3.5			
$V_{OH}$ High-level output voltage	$I_{OH} = -20\ \mu\text{A}$ $I_{OH} = -200\ \mu\text{A}$ $I_{OH} = -1\text{ mA}$	25°C	4.99		4.99			V	
		25°C	4.85	4.93		4.85	4.93		
		Full range	4.85		4.85				
		25°C	4.25	4.65		4.25	4.65		
$V_{OL}$ Low-level output voltage	$V_{IC} = 2.5\text{ V}$ , $I_{OL} = 50\ \mu\text{A}$ $V_{IC} = 2.5\text{ V}$ , $I_{OL} = 500\ \mu\text{A}$ $V_{IC} = 2.5\text{ V}$ , $I_{OL} = 5\text{ mA}$	25°C	0.01		0.01			V	
		25°C	0.09	0.15		0.09	0.15		
		Full range	0.15		0.15				
		25°C	0.9	1.5		0.9	1.5		
$A_{VD}$ Large-signal differential voltage amplification	$V_{IC} = 2.5\text{ V}$ , $V_O = 1\text{ V to }4\text{ V}$	$R_L = 10\text{ k}\Omega^\ddagger$	25°C	15	35		15	35	V/mV
			Full range	15		15			
		$R_L = 1\text{ M}\Omega^\ddagger$	25°C	175		175			
$r_{id}$ Differential input resistance		25°C	$10^{12}$			$10^{12}$		$\Omega$	
$r_i$ Common-mode input resistance		25°C	$10^{12}$			$10^{12}$		$\Omega$	
$C_i$ Common-mode input capacitance	$f = 10\text{ kHz}$ , N package	25°C	8			8		pF	
$z_o$ Closed-loop output impedance	$f = 1\text{ MHz}$ , $A_V = 10$	25°C	140			140		$\Omega$	
CMRR Common-mode rejection ratio	$V_{IC} = 0\text{ V to }2.7\text{ V}$ , $V_O = 2.5\text{ V}$ , $R_S = 50\ \Omega$	25°C	70	75		70	75	dB	
		Full range	70		70				
$k_{SVR}$ Supply-voltage rejection ratio ( $\Delta V_{DD}/\Delta V_{IO}$ )	$V_{DD} = 4.4\text{ V to }16\text{ V}$ , $V_{IC} = V_{DD}/2$ , No load	25°C	80	95		80	95	dB	
		Full range	80		80				
$I_{DD}$ Supply current	$V_O = 2.5\text{ V}$ , No load	25°C	4.4	6		4.4	6	mA	
		Full range	6		6				

† Full range is -40°C to 125°C.

‡ Referenced to 0 V

NOTE 4: Typical values are based on the input offset voltage shift observed through 168 hours of operating life test at  $T_A = 150^\circ\text{C}$  extrapolated to  $T_A = 25^\circ\text{C}$  using the Arrhenius equation and assuming an activation energy of 0.96 eV.



**TLC227x, TLC227xA**  
**Advanced LinCMOS™ RAIL-TO-RAIL**  
**OPERATIONAL AMPLIFIERS**

SLOS190G – FEBRUARY 1997 – REVISED MAY 2004

**TLC2274I operating characteristics at specified free-air temperature,  $V_{DD} = 5\text{ V}$**

PARAMETER	TEST CONDITIONS	$T_A$ †	TLC2274I			TLC2274AI			UNIT
			MIN	TYP	MAX	MIN	TYP	MAX	
SR	Slew rate at unity gain $V_O = 0.5\text{ V to }2.5\text{ V}$ , $R_L = 10\text{ k}\Omega^\ddagger$ , $C_L = 100\text{ pF}^\ddagger$	25°C	2.3	3.6		2.3	3.6	V/ $\mu\text{s}$	
		Full range	1.7			1.7			
$V_n$	Equivalent input noise voltage	f = 10 Hz		50			50	nV/ $\sqrt{\text{Hz}}$	
		f = 1 kHz		9			9		
$V_{N(PP)}$	Peak-to-peak equivalent input noise voltage	f = 0.1 Hz to 1 Hz		1			1	$\mu\text{V}$	
		f = 0.1 Hz to 10 Hz		1.4			1.4		
$I_n$	Equivalent input noise current	25°C		0.6			0.6	fA/ $\sqrt{\text{Hz}}$	
THD + N	Total harmonic distortion plus noise $V_O = 0.5\text{ V to }2.5\text{ V}$ , f = 20 kHz, $R_L = 10\text{ k}\Omega^\ddagger$	$A_V = 1$		0.0013%			0.0013%		
		$A_V = 10$	25°C		0.004%		0.004%		
		$A_V = 100$			0.03%		0.03%		
	Gain-bandwidth product f = 10 kHz, $R_L = 10\text{ k}\Omega^\ddagger$ , $C_L = 100\text{ pF}^\ddagger$	25°C		2.18			2.18	MHz	
BOM	Maximum output-swing bandwidth $V_{O(PP)} = 2\text{ V}$ , $A_V = 1$ , $R_L = 10\text{ k}\Omega^\ddagger$ , $C_L = 100\text{ pF}^\ddagger$	25°C		1			1	MHz	
$t_s$	Settling time $A_V = -1$ , Step = 0.5 V to 2.5 V, $R_L = 10\text{ k}\Omega^\ddagger$ , $C_L = 100\text{ pF}^\ddagger$	To 0.1%		1.5			1.5	$\mu\text{s}$	
		To 0.01%	25°C		2.6		2.6		
$\phi_m$	Phase margin at unity gain $R_L = 10\text{ k}\Omega^\ddagger$ , $C_L = 100\text{ pF}^\ddagger$	25°C		50°			50°		
	Gain margin	25°C		10			10	dB	

† Full range is – 40°C to 125°C.

‡ Referenced to 0 V

# TLC227x, TLC227xA Advanced LinCMOS™ RAIL-TO-RAIL OPERATIONAL AMPLIFIERS

SLOS190G – FEBRUARY 1997 – REVISED MAY 2004

**TLC2274I electrical characteristics at specified free-air temperature,  $V_{DD\pm} = \pm 5$  V (unless otherwise noted)**

PARAMETER	TEST CONDITIONS	$T_A$ †	TLC2274I			TLC2274AI			UNIT
			MIN	TYP	MAX	MIN	TYP	MAX	
$V_{IO}$ Input offset voltage	$V_{IC} = 0$ V, $V_O = 0$ V, $R_S = 50$ $\Omega$	25°C	300	2500		300	950		$\mu$ V
		Full range			3000		1500		
$\alpha_{VIO}$ Temperature coefficient of input offset voltage		25°C to 85°C	2			2			$\mu$ V/°C
Input offset voltage long-term drift (see Note 4)		25°C	0.002			0.002			$\mu$ V/mo
$I_{IO}$ Input offset current		25°C	0.5	60		0.5	60		pA
		–40°C to 85°C			150		150		
		Full range			800		800		
$I_{IB}$ Input bias current		25°C	1	60		1	60		pA
		–40°C to 85°C			150		150		
		Full range			800		800		
$V_{ICR}$ Common-mode input voltage	$R_S = 50$ $\Omega$ , $ V_{IO}  \leq 5$ mV	25°C	–5 to 4	–5.3 to 4.2		–5 to 4	–5.3 to 4.2		V
		Full range	–5 to 3.5			–5 to 3.5			
$V_{OM+}$ Maximum positive peak output voltage	$I_O = -20$ $\mu$ A	25°C		4.99			4.99		V
		25°C	4.85	4.93		4.85	4.93		
	$I_O = -200$ $\mu$ A	Full range	4.85			4.85			
		25°C	4.25	4.65		4.25	4.65		
$V_{OM-}$ Maximum negative peak output voltage	$V_{IC} = 0$ V, $I_O = 50$ $\mu$ A	25°C		–4.99			–4.99		V
		25°C	–4.85	–4.91		–4.85	–4.91		
	$V_{IC} = 0$ V, $I_O = 500$ $\mu$ A	Full range	–4.85			–4.85			
		25°C	–3.5	–4.1		–3.5	–4.1		
$A_{VD}$ Large-signal differential voltage amplification	$V_O = \pm 4$ V	$R_L = 10$ k $\Omega$	25°C	25	50		25	50	V/mV
			Full range	25			25		
		$R_L = 1$ M $\Omega$	25°C		300			300	
$r_{id}$ Differential input resistance		25°C		$10^{12}$			$10^{12}$	$\Omega$	
$r_i$ Common-mode input resistance		25°C		$10^{12}$			$10^{12}$	$\Omega$	
$c_i$ Common-mode input capacitance	$f = 10$ kHz, N package	25°C		8			8	pF	
$z_o$ Closed-loop output impedance	$f = 1$ MHz, $A_V = 10$	25°C		130			130	$\Omega$	
CMRR Common-mode rejection ratio	$V_{IC} = -5$ V to 2.7 V, $V_O = 0$ V, $R_S = 50$ $\Omega$	25°C	75	80		75	80		dB
		Full range	75			75			
$k_{SVR}$ Supply-voltage rejection ratio ( $\Delta V_{DD\pm}/\Delta V_{IO}$ )	$V_{DD\pm} = \pm 2.2$ V to $\pm 8$ V, $V_{IC} = 0$ V, No load	25°C	80	95		80	95		dB
		Full range	80			80			
$I_{DD}$ Supply current	$V_O = 0$ V, No load	25°C	4.8	6		4.8	6		mA
		Full range			6		6		

† Full range is –40°C to 125°C.

NOTE 4: Typical values are based on the input offset voltage shift observed through 168 hours of operating life test at  $T_A = 150^\circ\text{C}$  extrapolated to  $T_A = 25^\circ\text{C}$  using the Arrhenius equation and assuming an activation energy of 0.96 eV.



**TLC227x, TLC227xA**  
**Advanced LinCMOS™ RAIL-TO-RAIL**  
**OPERATIONAL AMPLIFIERS**

SLOS190G – FEBRUARY 1997 – REVISED MAY 2004

**TLC2274I operating characteristics at specified free-air temperature,  $V_{DD\pm} = \pm 5\text{ V}$**

PARAMETER	TEST CONDITIONS	$T_A$ †	TLC2274I			TLC2274AI			UNIT
			MIN	TYP	MAX	MIN	TYP	MAX	
SR	Slew rate at unity gain $V_O = \pm 2.3\text{ V}$ , $C_L = 100\text{ pF}$ , $R_L = 10\text{ k}\Omega$	25°C	2.3	3.6		2.3	3.6		V/ $\mu\text{s}$
		Full range	1.7			1.7			
$V_n$	Equivalent input noise voltage	f = 10 Hz		50			50		nV/ $\sqrt{\text{Hz}}$
		f = 1 kHz		9			9		
$V_{N(PP)}$	Peak-to-peak equivalent input noise voltage	f = 0.1 Hz to 1 Hz		1			1		$\mu\text{V}$
		f = 0.1 Hz to 10 Hz		1.4			1.4		
$I_n$	Equivalent input noise current	25°C		0.6			0.6	fA/ $\sqrt{\text{Hz}}$	
THD + N	Total harmonic distortion plus noise $V_O = \pm 2.3\text{ V}$ , $R_L = 10\text{ k}\Omega$ , f = 20 kHz	$A_V = 1$	25°C	0.0011%		0.0011%			
		$A_V = 10$		0.004%		0.004%			
		$A_V = 100$		0.03%		0.03%			
	Gain-bandwidth product	f = 10 kHz, $C_L = 100\text{ pF}$ , $R_L = 10\text{ k}\Omega$	25°C	2.25		2.25		MHz	
BOM	Maximum output-swing bandwidth	$V_{O(PP)} = 4.6\text{ V}$ , $R_L = 10\text{ k}\Omega$ , $A_V = 1$ , $C_L = 100\text{ pF}$	25°C	0.54		0.54		MHz	
$t_s$	Settling time	$A_V = -1$ , Step = -2.3 V to 2.3 V, $R_L = 10\text{ k}\Omega$ , $C_L = 100\text{ pF}$	To 0.1%	25°C	1.5		1.5		$\mu\text{s}$
			To 0.01%		3.2		3.2		
$\phi_m$	Phase margin at unity gain	$R_L = 10\text{ k}\Omega$ , $C_L = 100\text{ pF}$	25°C	52°		52°			
	Gain margin		25°C	10		10			dB

† Full range is -40°C to 125°C.

# TLC227x, TLC227xA Advanced LinCMOS™ RAIL-TO-RAIL OPERATIONAL AMPLIFIERS

SLOS190G – FEBRUARY 1997 – REVISED MAY 2004

**TLC2272Q and TLC2272M electrical characteristics at specified free-air temperature,  $V_{DD} = 5\text{ V}$  (unless otherwise noted)**

PARAMETER	TEST CONDITIONS	$T_A$ †	TLC2272Q, TLC2272M			TLC2272AQ, TLC2272AM			UNIT	
			MIN	TYP	MAX	MIN	TYP	MAX		
$V_{IO}$ Input offset voltage		25°C	300	2500		300	950	$\mu\text{V}$		
		Full range		3000		1500				
$\alpha_{VIO}$ Temperature coefficient of input offset voltage		25°C to 125°C	2			2			$\mu\text{V}/^\circ\text{C}$	
Input offset voltage long-term drift (see Note 4)	$V_{IC} = 0\text{ V},$ $V_O = 0\text{ V},$ $V_{DD\pm} = \pm 2.5\text{ V},$ $R_S = 50\ \Omega$	25°C	0.002			0.002			$\mu\text{V}/\text{mo}$	
$I_{IO}$ Input offset current		25°C	0.5	60		0.5	60	$\text{pA}$		
		Full range		800		800				
$I_{IB}$ Input bias current		25°C	1	60		1	60	$\text{pA}$		
		Full range		800		800				
$V_{ICR}$ Common-mode input voltage	$R_S = 50\ \Omega,$ $ V_{IO}  \leq 5\text{ mV}$	25°C	0 to 4	-0.3 to 4.2		0 to 4	-0.3 to 4.2	$\text{V}$		
		Full range	0 to 3.5			0 to 3.5				
$V_{OH}$ High-level output voltage	$I_{OH} = -20\ \mu\text{A}$ $I_{OH} = -200\ \mu\text{A}$ $I_{OH} = -1\text{ mA}$	25°C	4.99			4.99			$\text{V}$	
		25°C	4.85	4.93		4.85	4.93			
		Full range	4.85			4.85				
		25°C	4.25	4.65		4.25	4.65			
$V_{OL}$ Low-level output voltage	$V_{IC} = 2.5\text{ V},$ $I_{OL} = 50\ \mu\text{A}$ $V_{IC} = 2.5\text{ V},$ $I_{OL} = 500\ \mu\text{A}$ $V_{IC} = 2.5\text{ V},$ $I_{OL} = 5\text{ mA}$	25°C	0.01			0.01			$\text{V}$	
		25°C	0.09	0.15		0.09	0.15			
		Full range	0.15			0.15				
		25°C	0.9	1.5		0.9	1.5			
$A_{VD}$ Large-signal differential voltage amplification	$V_{IC} = 2.5\text{ V},$ $V_O = 1\text{ V to }4\text{ V}$	$R_L = 10\text{ k}\Omega$ ‡ $R_L = 1\text{ m}\Omega$ ‡	25°C	10	35		10	35	$\text{V}/\text{mV}$	
			Full range	10			10			
			25°C	175			175			
$r_{id}$ Differential input resistance		25°C	$10^{12}$			$10^{12}$			$\Omega$	
$r_i$ Common-mode input resistance		25°C	$10^{12}$			$10^{12}$			$\Omega$	
$C_i$ Common-mode input capacitance	$f = 10\text{ kHz},$ P package	25°C	8			8			$\text{pF}$	
$z_o$ Closed-loop output impedance	$f = 1\text{ MHz},$ $A_V = 10$	25°C	140			140			$\Omega$	
CMRR Common-mode rejection ratio	$V_{IC} = 0\text{ V to }2.7\text{ V},$ $V_O = 2.5\text{ V},$ $R_S = 50\ \Omega$	25°C	70	75		70	75	$\text{dB}$		
		Full range	70			70				
$k_{SVR}$ Supply-voltage rejection ratio ( $\Delta V_{DD}/\Delta V_{IO}$ )	$V_{DD} = 4.4\text{ V to }16\text{ V},$ $V_{IC} = V_{DD}/2,$ No load	25°C	80	95		80	95	$\text{dB}$		
		Full range	80			80				
$I_{DD}$ Supply current	$V_O = 2.5\text{ V},$ No load	25°C	2.2	3		2.2	3	$\text{mA}$		
		Full range	3			3				

† Full range is  $-40^\circ\text{C}$  to  $125^\circ\text{C}$  for Q level part,  $-55^\circ\text{C}$  to  $125^\circ\text{C}$  for M level part.

‡ Referenced to 2.5 V

NOTE 4: Typical values are based on the input offset voltage shift observed through 168 hours of operating life test at  $T_A = 150^\circ\text{C}$  extrapolated to  $T_A = 25^\circ\text{C}$  using the Arrhenius equation and assuming an activation energy of 0.96 eV.



**TLC227x, TLC227xA**  
**Advanced LinCMOS™ RAIL-TO-RAIL**  
**OPERATIONAL AMPLIFIERS**

SLOS190G – FEBRUARY 1997 – REVISED MAY 2004

**TLC2272Q and TLC2272M operating characteristics at specified free-air temperature,  $V_{DD} = 5\text{ V}$**

PARAMETER	TEST CONDITIONS	$T_A$ †	TLC2272Q, TLC2272M			TLC2272AQ, TLC2272AM			UNIT
			MIN	TYP	MAX	MIN	TYP	MAX	
SR	Slew rate at unity gain $V_O = 1.25\text{ V to }2.75\text{ V}$ , $R_L = 10\text{ k}\Omega$ ‡, $C_L = 100\text{ pF}$ ‡	25°C	2.3	3.6		2.3	3.6		V/ $\mu\text{s}$
		Full range	1.7			1.7			
$V_n$	Equivalent input noise voltage	f = 10 Hz		50			50		nV/ $\sqrt{\text{Hz}}$
		f = 1 kHz		9			9		
$V_{NPP}$	Peak-to-peak equivalent input noise voltage	f = 0.1 Hz to 1 Hz		1			1		$\mu\text{V}$
		f = 0.1 Hz to 10 Hz		1.4			1.4		
$I_n$	Equivalent input noise current	25°C		0.6			0.6	fA/ $\sqrt{\text{Hz}}$	
THD + N	Total harmonic distortion plus noise $V_O = 0.5\text{ V to }2.5\text{ V}$ , f = 20 kHz, $R_L = 10\text{ k}\Omega$ ‡	$A_V = 1$		0.0013%			0.0013%		
		$A_V = 10$	25°C		0.004%		0.004%		
		$A_V = 100$			0.03%		0.03%		
	Gain-bandwidth product	f = 10 kHz, $R_L = 10\text{ k}\Omega$ ‡, $C_L = 100\text{ pF}$ ‡	25°C		2.18		2.18		MHz
$B_{OM}$	Maximum output-swing bandwidth	$V_{O(PP)} = 2\text{ V}$ , $R_L = 10\text{ k}\Omega$ ‡, $A_V = 1$ , $C_L = 100\text{ pF}$ ‡	25°C		1		1		MHz
$t_s$	Settling time	$A_V = -1$ , Step = 0.5 V to 2.5 V, $R_L = 10\text{ k}\Omega$ ‡, $C_L = 100\text{ pF}$ ‡	To 0.1%		1.5		1.5		$\mu\text{s}$
		To 0.01%	25°C		2.6		2.6		
$\phi_m$	Phase margin at unity gain	$R_L = 10\text{ k}\Omega$ ‡, $C_L = 100\text{ pF}$ ‡	25°C		50°		50°		
	Gain margin		25°C		10		10		

† Full range is  $-40^\circ\text{C}$  to  $125^\circ\text{C}$  for Q level part,  $-55^\circ\text{C}$  to  $125^\circ\text{C}$  for M level part.

‡ Referenced to 2.5 V

# TLC227x, TLC227xA Advanced LinCMOS™ RAIL-TO-RAIL OPERATIONAL AMPLIFIERS

SLOS190G – FEBRUARY 1997 – REVISED MAY 2004

**TLC2272Q and TLC2272M electrical characteristics at specified free-air temperature,  $V_{DD\pm} = \pm 5\text{ V}$  (unless otherwise noted)**

PARAMETER	TEST CONDITIONS	$T_A$ †	TLC2272Q, TLC2272M			TLC2272AQ, TLC2272AM			UNIT
			MIN	TYP	MAX	MIN	TYP	MAX	
$V_{IO}$ Input offset voltage		25°C	300	2500		300	950	$\mu\text{V}$	
		Full range			3000		1500		
$\alpha_{VIO}$ Temperature coefficient of input offset voltage		25°C to 125°C	2			2			$\mu\text{V}/^\circ\text{C}$
Input offset voltage long-term drift (see Note 4)	$V_{IC} = 0\text{ V},$ $R_S = 50\ \Omega$ $V_O = 0\text{ V},$	25°C	0.002			0.002			$\mu\text{V}/\text{mo}$
$I_{IO}$ Input offset current		25°C	0.5	60		0.5	60	$\text{pA}$	
		Full range			800		800		
$I_{IB}$ Input bias current		25°C	1		60	1		60	$\text{pA}$
		Full range			800			800	
$V_{ICR}$ Common-mode input voltage	$R_S = 50\ \Omega,$ $ V_{IO}  \leq 5\text{ mV}$	25°C	-5 to 4	-5.3 to 4.2		-5 to 4	-5.3 to 4.2	$\text{V}$	
		Full range	-5 to 3.5			-5 to 3.5			
$V_{OM+}$ Maximum positive peak output voltage	$I_O = -20\ \mu\text{A}$ $I_O = -200\ \mu\text{A}$ $I_O = -1\text{ mA}$	25°C	4.99			4.99		$\text{V}$	
		25°C	4.85	4.93		4.85	4.93		
		Full range	4.85			4.85			
		25°C	4.25	4.65		4.25	4.65		
$V_{OM-}$ Maximum negative peak output voltage	$V_{IC} = 0\text{ V},$ $I_O = 50\ \mu\text{A}$ $V_{IC} = 0\text{ V},$ $I_O = 500\ \mu\text{A}$ $V_{IC} = 0\text{ V},$ $I_O = 5\text{ mA}$	25°C	-4.99			-4.99		$\text{V}$	
		25°C	-4.85	-4.91		-4.85	-4.91		
		Full range	-4.85			-4.85			
		25°C	-3.5	-4.1		-3.5	-4.1		
$V_{OM-}$ Maximum negative peak output voltage	$V_{IC} = 0\text{ V},$ $I_O = 5\text{ mA}$	25°C	-3.5			-3.5		$\text{V}$	
		Full range	-3.5			-3.5			
		25°C	-3.5			-3.5			
$AVD$ Large-signal differential voltage amplification	$V_O = \pm 4\text{ V}$	$R_L = 10\text{ k}\Omega$	25°C	20	50		20	50	$\text{V}/\text{mV}$
			Full range	20			20		
		$R_L = 1\text{ m}\Omega$	25°C	300			300		
$r_{id}$ Differential input resistance		25°C	$10^{12}$			$10^{12}$			$\Omega$
$r_i$ Common-mode input resistance		25°C	$10^{12}$			$10^{12}$			$\Omega$
$c_i$ Common-mode input capacitance	$f = 10\text{ kHz},$ P package	25°C	8			8			$\text{pF}$
$z_o$ Closed-loop output impedance	$f = 1\text{ MHz},$ $A_V = 10$	25°C	130			130			$\Omega$
CMRR Common-mode rejection ratio	$V_{IC} = -5\text{ V to } 2.7\text{ V},$ $V_O = 0\text{ V},$ $R_S = 50\ \Omega$	25°C	75	80		75	80	$\text{dB}$	
		Full range	75			75			
$k_{SVR}$ Supply-voltage rejection ratio ( $\Delta V_{DD\pm}/\Delta V_{IO}$ )	$V_{DD} = \pm 2.2\text{ V to } \pm 8\text{ V},$ $V_{IC} = 0\text{ V},$ No load	25°C	80	95		80	95	$\text{dB}$	
		Full range	80			80			
$I_{DD}$ Supply current	$V_O = 2.5\text{ V},$ No load	25°C	2.4	3		2.4	3	$\text{mA}$	
		Full range	3			3			

† Full range is -40°C to 125°C for Q level part, -55°C to 125°C for M level part.

NOTE 4: Typical values are based on the input offset voltage shift observed through 168 hours of operating life test at  $T_A = 150^\circ\text{C}$  extrapolated to  $T_A = 25^\circ\text{C}$  using the Arrhenius equation and assuming an activation energy of 0.96 eV.



**TLC227x, TLC227xA**  
**Advanced LinCMOS™ RAIL-TO-RAIL**  
**OPERATIONAL AMPLIFIERS**

SLOS190G – FEBRUARY 1997 – REVISED MAY 2004

**TLC2272Q and TLC2272M operating characteristics at specified free-air temperature,  
 $V_{DD\pm} = \pm 5\text{ V}$**

PARAMETER	TEST CONDITIONS	$T_A$ †	TLC2272Q, TLC2272M			TLC2272AQ, TLC2272AM			UNIT		
			MIN	TYP	MAX	MIN	TYP	MAX			
SR	Slew rate at unity gain	$V_O = \pm 1\text{ V},$ $C_L = 100\text{ pF}$ $R_L = 10\text{ k}\Omega,$	25°C	2.3	3.6		2.3	3.6	V/ $\mu$ s		
			Full range	1.7			1.7				
$V_n$	Equivalent input noise voltage	$f = 10\text{ Hz}$ $f = 1\text{ kHz}$	25°C	50			50			nV/ $\sqrt{\text{Hz}}$	
			25°C	9			9				
$V_{NPP}$	Peak-to-peak equivalent input noise voltage	$f = 0.1\text{ Hz to }1\text{ Hz}$ $f = 0.1\text{ Hz to }10\text{ Hz}$	25°C	1			1			$\mu$ V	
			25°C	1.4			1.4				
$I_n$	Equivalent input noise current		25°C	0.6			0.6			fA/ $\sqrt{\text{Hz}}$	
THD + N	Total harmonic distortion plus noise	$V_O = \pm 2.3\text{ V}$ $R_L = 10\text{ k}\Omega,$ $f = 20\text{ kHz}$	25°C	$A_V = 1$	0.0011%			0.0011%			
				$A_V = 10$	0.004%			0.004%			
				$A_V = 100$	0.03%			0.03%			
	Gain-bandwidth product	$f = 10\text{ kHz},$ $C_L = 100\text{ pF}$ $R_L = 10\text{ k}\Omega,$	25°C	2.25			2.25			MHz	
BOM	Maximum output-swing bandwidth	$V_{O(PP)} = 4.6\text{ V},$ $R_L = 10\text{ k}\Omega,$ $A_V = 1,$ $C_L = 100\text{ pF}$	25°C	0.54			0.54			MHz	
$t_s$	Settling time	$A_V = -1,$ Step = $-2.3\text{ V to }2.3\text{ V},$ $R_L = 10\text{ k}\Omega,$ $C_L = 100\text{ pF}$	25°C	To 0.1%	1.5			1.5			$\mu$ s
				To 0.01%	3.2			3.2			
$\phi_m$	Phase margin at unity gain	$R_L = 10\text{ k}\Omega,$ $C_L = 100\text{ pF}$	25°C	52°			52°				
	Gain margin		25°C	10			10			dB	

† Full range is  $-40^\circ\text{C}$  to  $125^\circ\text{C}$  for Q level part,  $-55^\circ\text{C}$  to  $125^\circ\text{C}$  for M level part.

# TLC227x, TLC227xA Advanced LinCMOS™ RAIL-TO-RAIL OPERATIONAL AMPLIFIERS

SLOS190G – FEBRUARY 1997 – REVISED MAY 2004

**TLC2274Q and TLC2274M electrical characteristics at specified free-air temperature,  $V_{DD} = 5\text{ V}$  (unless otherwise noted)**

PARAMETER	TEST CONDITIONS	$T_A$ †	TLC2274Q, TLC2274M			TLC2274AQ, TLC2274AM			UNIT
			MIN	TYP	MAX	MIN	TYP	MAX	
$V_{IO}$ Input offset voltage		25°C	300	2500		300	950	$\mu\text{V}$	
		Full range			3000		1500		
$\alpha_{VIO}$ Temperature coefficient of input offset voltage		25°C to 125°C	2			2			$\mu\text{V}/^\circ\text{C}$
Input offset voltage long-term drift (see Note 4)	$V_{DD\pm} = \pm 2.5\text{ V}$ , $V_O = 0\text{ V}$ , $V_{IC} = 0\text{ V}$ , $R_S = 50\ \Omega$	25°C	0.002			0.002			$\mu\text{V}/\text{mo}$
$I_{IO}$ Input offset current		25°C	0.5	60		0.5	60	$\text{pA}$	
		Full range			800		800		
$I_{IB}$ Input bias current		25°C	1		60	1		60	$\text{pA}$
		Full range			800			800	
$V_{ICR}$ Common-mode input voltage	$R_S = 50\ \Omega$ , $ V_{IO}  \leq 5\text{ mV}$	25°C	0 to 4	-0.3 to 4.2		0 to 4	-0.3 to 4.2	$\text{V}$	
		Full range	0 to 3.5			0 to 3.5			
$V_{OH}$ High-level output voltage	$I_{OH} = -20\ \mu\text{A}$ $I_{OH} = -200\ \mu\text{A}$ $I_{OH} = -1\text{ mA}$	25°C	4.99			4.99		$\text{V}$	
		25°C	4.85	4.93		4.85	4.93		
		Full range	4.85			4.85			
		25°C	4.25	4.65		4.25	4.65		
$V_{OL}$ Low-level output voltage	$V_{IC} = 2.5\text{ V}$ , $I_{OL} = 50\ \mu\text{A}$ $V_{IC} = 2.5\text{ V}$ , $I_{OL} = 500\ \mu\text{A}$ $V_{IC} = 2.5\text{ V}$ , $I_{OL} = 5\text{ mA}$	25°C	0.01			0.01		$\text{V}$	
		25°C	0.09	0.15		0.09	0.15		
		Full range	0.15			0.15			
		25°C	0.9	1.5		0.9	1.5		
$AVD$ Large-signal differential voltage amplification	$V_{IC} = 2.5\text{ V}$ , $V_O = 1\text{ V to }4\text{ V}$	$R_L = 10\text{ k}\Omega^\ddagger$	25°C	10	35		10	35	$\text{V}/\text{mV}$
			Full range	10			10		
		$R_L = 1\text{ M}\Omega^\ddagger$	25°C	175			175		
$r_{id}$ Differential input resistance		25°C	$10^{12}$			$10^{12}$			$\Omega$
$r_i$ Common-mode input resistance		25°C	$10^{12}$			$10^{12}$			$\Omega$
$c_i$ Common-mode input capacitance	$f = 10\text{ kHz}$ , N package	25°C	8			8			$\text{pF}$
$z_o$ Closed-loop output impedance	$f = 1\text{ MHz}$ , $A_V = 10$	25°C	140			140			$\Omega$
CMRR Common-mode rejection ratio	$V_{IC} = 0\text{ V to }2.7\text{ V}$ , $V_O = 2.5\text{ V}$ , $R_S = 50\ \Omega$	25°C	70	75		70	75	$\text{dB}$	
		Full range	70			70			
$k_{SVR}$ Supply-voltage rejection ratio ( $\Delta V_{DD}/\Delta V_{IO}$ )	$V_{DD} = 4.4\text{ V to }16\text{ V}$ , $V_{IC} = V_{DD}/2$ , No load	25°C	80	95		80	95	$\text{dB}$	
		Full range	80			80			
$I_{DD}$ Supply current	$V_O = 2.5\text{ V}$ , No load	25°C	4.4	6		4.4	6	$\text{mA}$	
		Full range	6			6			

† Full range is  $-40^\circ\text{C}$  to  $125^\circ\text{C}$  for Q level part,  $-55^\circ\text{C}$  to  $125^\circ\text{C}$  for M level part.

‡ Referenced to 2.5 V

NOTE 4: Typical values are based on the input offset voltage shift observed through 168 hours of operating life test at  $T_A = 150^\circ\text{C}$  extrapolated to  $T_A = 25^\circ\text{C}$  using the Arrhenius equation and assuming an activation energy of 0.96 eV.



**TLC227x, TLC227xA**  
**Advanced LinCMOS™ RAIL-TO-RAIL**  
**OPERATIONAL AMPLIFIERS**

SLOS190G – FEBRUARY 1997 – REVISED MAY 2004

**TLC2274Q and TLC2274M operating characteristics at specified free-air temperature,  $V_{DD} = 5\text{ V}$**

PARAMETER	TEST CONDITIONS	$T_A$ †	TLC2274Q, TLC2274M			TLC2274AQ, TLC2274AM			UNIT	
			MIN	TYP	MAX	MIN	TYP	MAX		
SR	Slew rate at unity gain $V_O = 0.5\text{ V to }2.5\text{ V}, C_L = 100\text{ pF}‡$ $R_L = 10\text{ k}\Omega‡$	25°C	2.3	3.6		2.3	3.6		V/ $\mu$ s	
		Full range	1.7			1.7				
$V_n$	Equivalent input noise voltage $f = 10\text{ Hz}$ $f = 1\text{ kHz}$	25°C	50			50			nV/ $\sqrt{\text{Hz}}$	
		25°C	9			9				
$V_{N(PP)}$	Peak-to-peak equivalent input noise voltage $f = 0.1\text{ Hz to }1\text{ Hz}$ $f = 0.1\text{ Hz to }10\text{ Hz}$	25°C	1			1			$\mu$ V	
		25°C	1.4			1.4				
$I_n$	Equivalent input noise current	25°C	0.6			0.6			fA/ $\sqrt{\text{Hz}}$	
THD + N	Total harmonic distortion plus noise $V_O = 0.5\text{ V to }2.5\text{ V}, f = 20\text{ kHz}, R_L = 10\text{ k}\Omega‡$	25°C	$A_V = 1$	0.0013%			0.0013%			
			$A_V = 10$	0.004%			0.004%			
			$A_V = 100$	0.03%			0.03%			
	Gain-bandwidth product $f = 10\text{ kHz}, C_L = 100\text{ pF}‡$	25°C	2.18			2.18			MHz	
$B_{OM}$	Maximum output-swing bandwidth $V_{O(PP)} = 2\text{ V}, R_L = 10\text{ k}\Omega‡$	25°C	1			1			MHz	
$t_s$	Settling time $A_V = -1, \text{ Step} = 0.5\text{ V to }2.5\text{ V}, R_L = 10\text{ k}\Omega‡, C_L = 100\text{ pF}‡$	25°C	To 0.1%	1.5			1.5			$\mu$ s
			To 0.01%	2.6			2.6			
$\phi_m$	Phase margin at unity gain $R_L = 10\text{ k}\Omega‡, C_L = 100\text{ pF}‡$	25°C	50°			50°				
		25°C	10			10				dB

† Full range is  $-40^\circ\text{C}$  to  $125^\circ\text{C}$  for Q level part,  $-55^\circ\text{C}$  to  $125^\circ\text{C}$  for M level part.

‡ Referenced to 2.5 V

# TLC227x, TLC227xA Advanced LinCMOS™ RAIL-TO-RAIL OPERATIONAL AMPLIFIERS

SLOS190G – FEBRUARY 1997 – REVISED MAY 2004

**TLC2274Q and TLC2274M electrical characteristics at specified free-air temperature,  $V_{DD\pm} = \pm 5\text{ V}$  (unless otherwise noted)**

PARAMETER	TEST CONDITIONS	$T_A$ †	TLC2274Q, TLC2274M			TLC2274AQ, TLC2274AM			UNIT
			MIN	TYP	MAX	MIN	TYP	MAX	
$V_{IO}$ Input offset voltage	$V_{IC} = 0\text{ V}, V_O = 0\text{ V}, R_S = 50\ \Omega$	25°C	300	2500		300	950	$\mu\text{V}$	
		Full range			3000		1500		
$\alpha_{VIO}$ Temperature coefficient of input offset voltage		25°C to 125°C	2			2		$\mu\text{V}/^\circ\text{C}$	
Input offset voltage long-term drift (see Note 4)		25°C	0.002			0.002		$\mu\text{V}/\text{mo}$	
$I_{IO}$ Input offset current		25°C	0.5	60		0.5	60	$\text{pA}$	
		Full range			800		800		
$I_{IB}$ Input bias current	25°C	1	60		1	60	$\text{pA}$		
	Full range			800		800			
$V_{ICR}$ Common-mode input voltage	$R_S = 50\ \Omega,  V_{IO}  \leq 5\text{ mV}$	25°C	-5 to 4	-5.3 to 4.2		-5 to 4	-5.3 to 4.2	$\text{V}$	
		Full range			-5 to 3.5		-5 to 3.5		
$V_{OM+}$ Maximum positive peak output voltage	$I_O = -20\ \mu\text{A}$	25°C	4.85	4.93		4.85	4.93	$\text{V}$	
		Full range	4.85			4.85			
		25°C	4.25	4.65		4.25	4.65		
		Full range	4.25			4.25			
$V_{OM-}$ Maximum negative peak output voltage	$V_{IC} = 0\text{ V}, I_O = 50\ \mu\text{A}$	25°C	-4.85	-4.91		-4.85	-4.91	$\text{V}$	
		Full range	-4.85			-4.85			
		25°C	-3.5	-4.1		-3.5	-4.1		
		Full range	-3.5			-3.5			
$V_{IC} = 0\text{ V}, I_O = 500\ \mu\text{A}$	25°C	-4.85	-4.91		-4.85	-4.91	$\text{V}$		
	Full range	-4.85			-4.85				
	25°C	-3.5	-4.1		-3.5	-4.1			
$V_{IC} = 0\text{ V}, I_O = 5\text{ mA}$	25°C	-3.5	-4.1		-3.5	-4.1	$\text{V}$		
	Full range	-3.5			-3.5				
	25°C	-3.5	-4.1		-3.5	-4.1			
$AVD$ Large-signal differential voltage amplification	$V_O = \pm 4\text{ V}$	$R_L = 10\text{ k}\Omega$	25°C	20	50		20	50	$\text{V}/\text{mV}$
			Full range	20			20		
		$R_L = 1\text{ M}\Omega$	25°C	300			300		
$r_{id}$ Differential input resistance		25°C	$10^{12}$			$10^{12}$		$\Omega$	
$r_i$ Common-mode input resistance		25°C	$10^{12}$			$10^{12}$		$\Omega$	
$c_i$ Common-mode input capacitance	$f = 10\text{ kHz}, \text{ N package}$	25°C	8			8		$\text{pF}$	
$z_o$ Closed-loop output impedance	$f = 1\text{ MHz}, A_V = 10$	25°C	130			130		$\Omega$	
CMRR Common-mode rejection ratio	$V_{IC} = -5\text{ V to } 2.7\text{ V}, V_O = 0\text{ V}, R_S = 50\ \Omega$	25°C	75	80		75	80	$\text{dB}$	
		Full range	75			75			
$k_{SVR}$ Supply-voltage rejection ratio ( $\Delta V_{DD\pm}/\Delta V_{IO}$ )	$V_{DD\pm} = \pm 2.2\text{ V to } \pm 8\text{ V}, V_{IC} = 0\text{ V}, \text{ No load}$	25°C	80	95		80	95	$\text{dB}$	
		Full range	80			80			
$I_{DD}$ Supply current	$V_O = 0\text{ V}, \text{ No load}$	25°C	4.8	6		4.8	6	$\text{mA}$	
		Full range			6		6		

† Full range is  $-40^\circ\text{C}$  to  $125^\circ\text{C}$  for Q level part,  $-55^\circ\text{C}$  to  $125^\circ\text{C}$  for M level part.

NOTE 4: Typical values are based on the input offset voltage shift observed through 168 hours of operating life test at  $T_A = 150^\circ\text{C}$  extrapolated to  $T_A = 25^\circ\text{C}$  using the Arrhenius equation and assuming an activation energy of 0.96 eV.



**TLC227x, TLC227xA**  
**Advanced LinCMOS™ RAIL-TO-RAIL**  
**OPERATIONAL AMPLIFIERS**

SLOS190G – FEBRUARY 1997 – REVISED MAY 2004

**TLC2274Q and TLC2274M operating characteristics at specified free-air temperature,  
 $V_{DD\pm} = \pm 5\text{ V}$**

PARAMETER	TEST CONDITIONS	$T_A$ †	TLC2274Q, TLC2274M			TLC2274AQ, TLC2274AM			UNIT
			MIN	TYP	MAX	MIN	TYP	MAX	
SR	Slew rate at unity gain $V_O = \pm 2.3\text{ V},$ $R_L = 10\text{ k}\Omega,$ $C_L = 100\text{ pF}$	25°C	2.3	3.6		2.3	3.6		V/ $\mu\text{s}$
		Full range	1.7			1.7			
$V_n$	Equivalent input noise voltage $f = 10\text{ Hz}$ $f = 1\text{ kHz}$	25°C		50			50		nV/ $\sqrt{\text{Hz}}$
		25°C		9			9		
$V_{N(PP)}$	Peak-to-peak equivalent input noise voltage $f = 0.1\text{ Hz to }1\text{ Hz}$ $f = 0.1\text{ Hz to }10\text{ Hz}$	25°C		1			1		$\mu\text{V}$
		25°C		1.4			1.4		
$I_n$	Equivalent input noise current	25°C		0.6			0.6		fA/ $\sqrt{\text{Hz}}$
THD + N	Total harmonic distortion plus noise $V_O = \pm 2.3\text{ V},$ $R_L = 10\text{ k}\Omega,$ $f = 20\text{ kHz}$	25°C		$A_V = 1$		0.0011%		0.0011%	
				$A_V = 10$		0.004%		0.004%	
				$A_V = 100$		0.03%		0.03%	
	Gain-bandwidth product $f = 10\text{ kHz},$ $R_L = 10\text{ k}\Omega,$ $C_L = 100\text{ pF}$	25°C		2.25			2.25		MHz
BOM	Maximum output-swing bandwidth $V_{O(PP)} = 4.6\text{ V},$ $R_L = 10\text{ k}\Omega,$ $A_V = 1,$ $C_L = 100\text{ pF}$	25°C		0.54			0.54		MHz
$t_s$	Settling time $A_V = -1,$ Step = $-2.3\text{ V to }2.3\text{ V},$ $R_L = 10\text{ k}\Omega,$ $C_L = 100\text{ pF}$	25°C		To 0.1%		1.5		1.5	$\mu\text{s}$
				To 0.01%		3.2		3.2	
$\phi_m$	Phase margin at unit gain $R_L = 10\text{ k}\Omega,$ $C_L = 100\text{ pF}$	25°C		52°			52°		
		25°C		10			10		dB

† Full range is  $-40^\circ\text{C}$  to  $125^\circ\text{C}$  for Q level part,  $-55^\circ\text{C}$  to  $125^\circ\text{C}$  for M level part.

**TLC227x, TLC227xA**  
**Advanced LinCMOS™ RAIL-TO-RAIL**  
**OPERATIONAL AMPLIFIERS**

SLOS190G – FEBRUARY 1997 – REVISED MAY 2004

**TYPICAL CHARACTERISTICS**

**Table of Graphs**

			<b>FIGURE</b>
$V_{IO}$	Input offset voltage	Distribution vs Common-mode voltage	1 – 4 5, 6
$\alpha V_{IO}$	Input offset voltage temperature coefficient	Distribution	7 – 10
$I_{IB}/I_{IO}$	Input bias and input offset current	vs Free-air temperature	11
$V_I$	Input voltage	vs Supply voltage vs Free-air temperature	12 13
$V_{OH}$	High-level output voltage	vs High-level output current	14
$V_{OL}$	Low-level output voltage	vs Low-level output current	15, 16
$V_{OM+}$	Maximum positive peak output voltage	vs Output current	17
$V_{OM-}$	Maximum negative peak output voltage	vs Output current	18
$V_{O(PP)}$	Maximum peak-to-peak output voltage	vs Frequency	19
$I_{OS}$	Short-circuit output current	vs Supply voltage vs Free-air temperature	20 21
$V_O$	Output voltage	vs Differential input voltage	22, 23
$A_{VD}$	Large-signal differential voltage amplification	vs Load resistance	24
	Large-signal differential voltage amplification and phase margin	vs Frequency	25, 26
	Large-signal differential voltage amplification	vs Free-air temperature	27, 28
$z_o$	Output impedance	vs Frequency	29, 30
CMRR	Common-mode rejection ratio	vs Frequency	31
		vs Free-air temperature	32
kSVR	Supply-voltage rejection ratio	vs Frequency	33, 34
		vs Free-air temperature	35
$I_{DD}$	Supply current	vs Supply voltage	36, 37
		vs Free-air temperature	38, 39
SR	Slew rate	vs Load capacitance	40
		vs Free-air temperature	41
$V_O$	Inverting large-signal pulse response		42, 43
	Voltage-follower large-signal pulse response		44, 45
	Inverting small-signal pulse response		46, 47
	Voltage-follower small-signal pulse response		48, 49
$V_n$	Equivalent input noise voltage	vs Frequency	50, 51
	Noise voltage over a 10-second period		52
	Integrated noise voltage	vs Frequency	53
THD + N	Total harmonic distortion plus noise	vs Frequency	54
	Gain-bandwidth product	vs Supply voltage	55
		vs Free-air temperature	56
$\phi_m$	Phase margin	vs Load capacitance	57
	Gain margin	vs Load capacitance	58

NOTE: For all graphs where  $V_{DD} = 5\text{ V}$ , all loads are referenced to 2.5 V.



TYPICAL CHARACTERISTICS

DISTRIBUTION OF TLC2272  
 INPUT OFFSET VOLTAGE

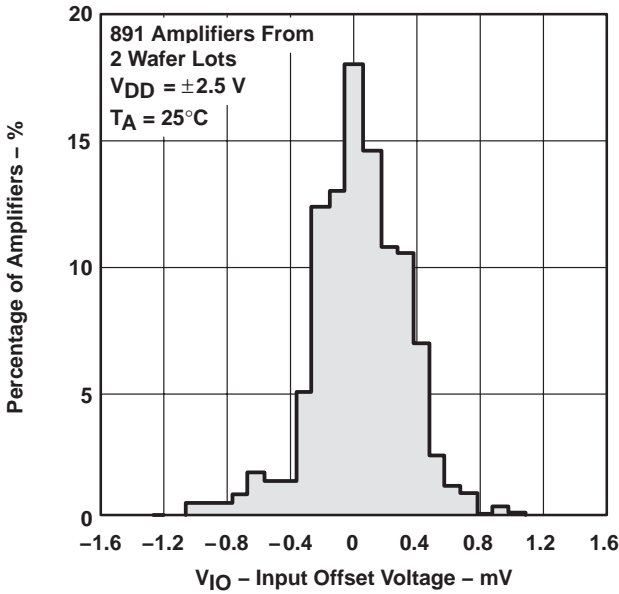

Figure 1

DISTRIBUTION OF TLC2272  
 INPUT OFFSET VOLTAGE

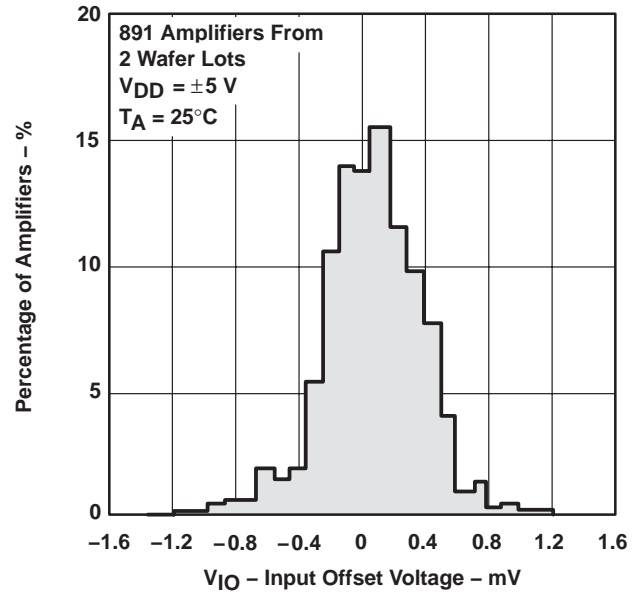

Figure 2

DISTRIBUTION OF TLC2274  
 INPUT OFFSET VOLTAGE

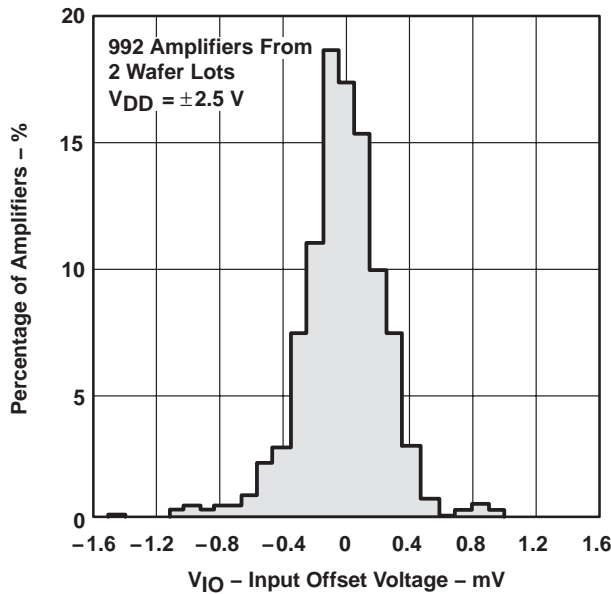

Figure 3

DISTRIBUTION OF TLC2274  
 INPUT OFFSET VOLTAGE

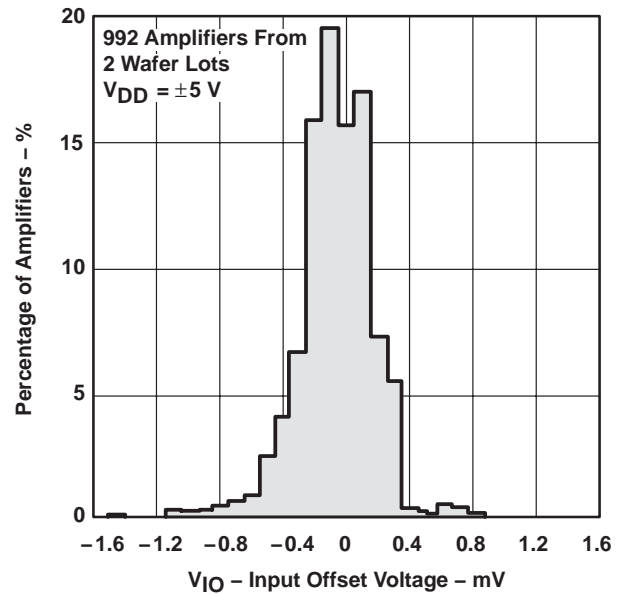
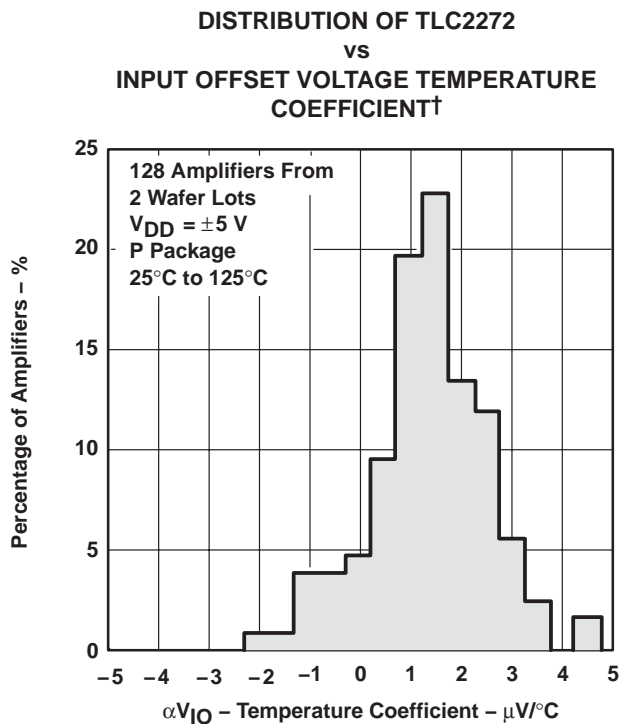
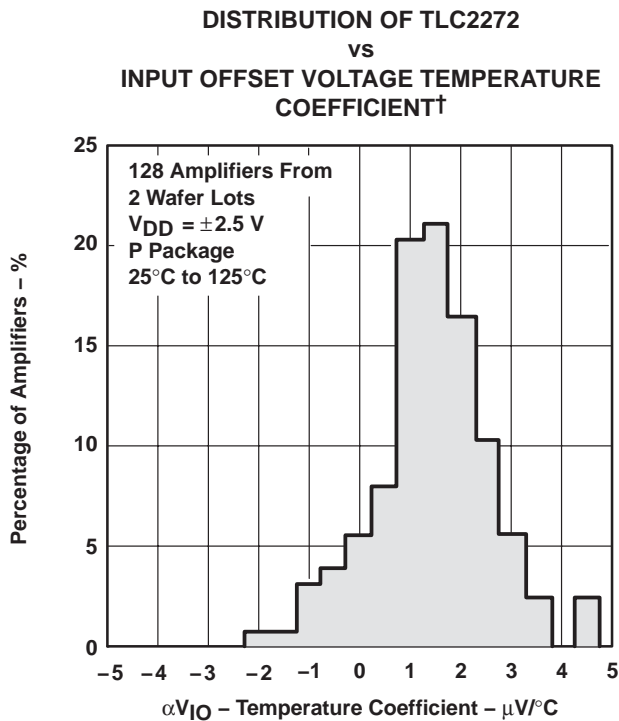
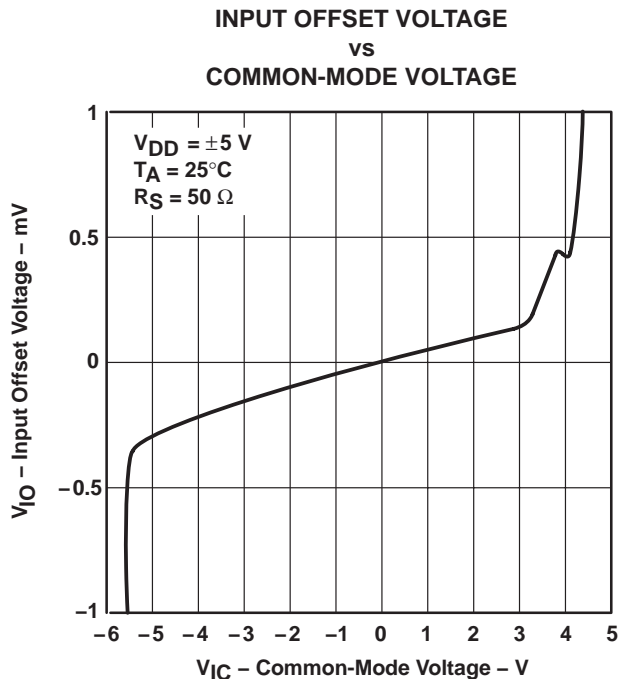
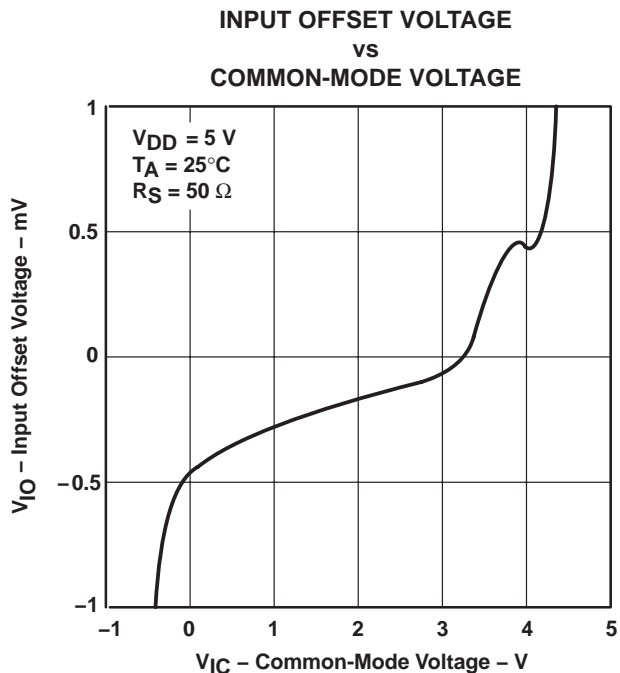

Figure 4

**TYPICAL CHARACTERISTICS**



† Data at high and low temperatures are applicable only within the rated operating free-air temperature ranges of the various devices.

TYPICAL CHARACTERISTICS

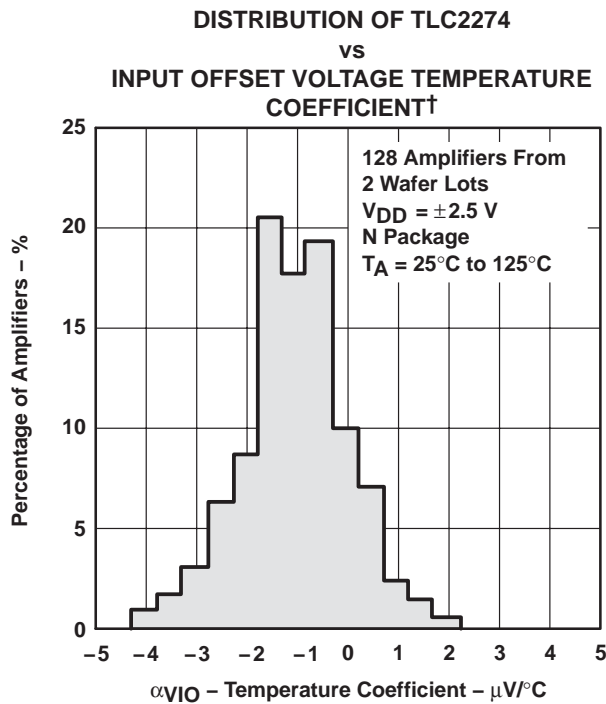

Figure 9

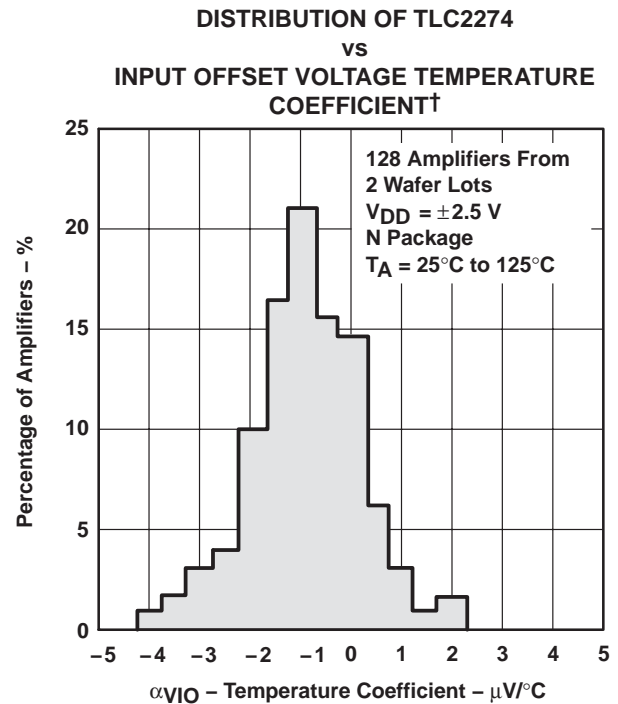

Figure 10

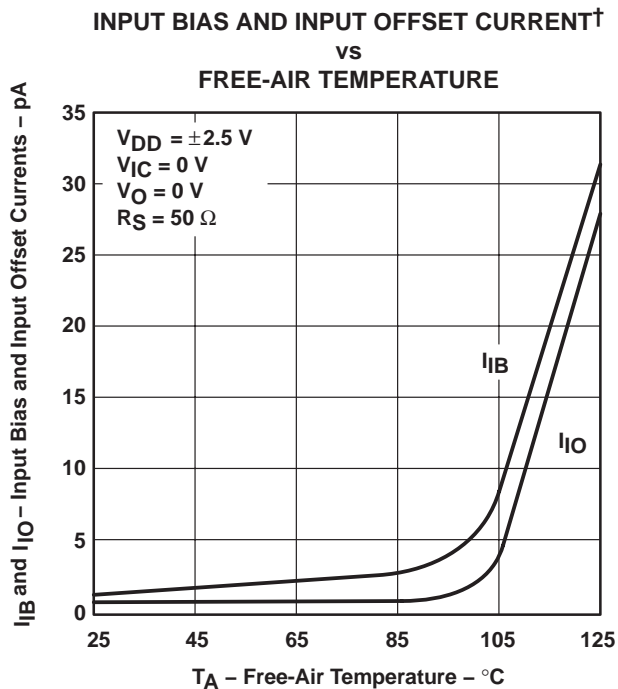

Figure 11

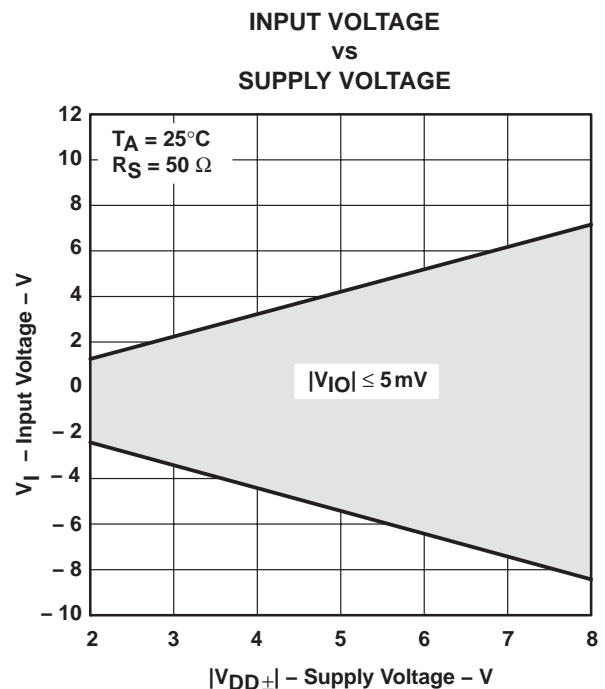
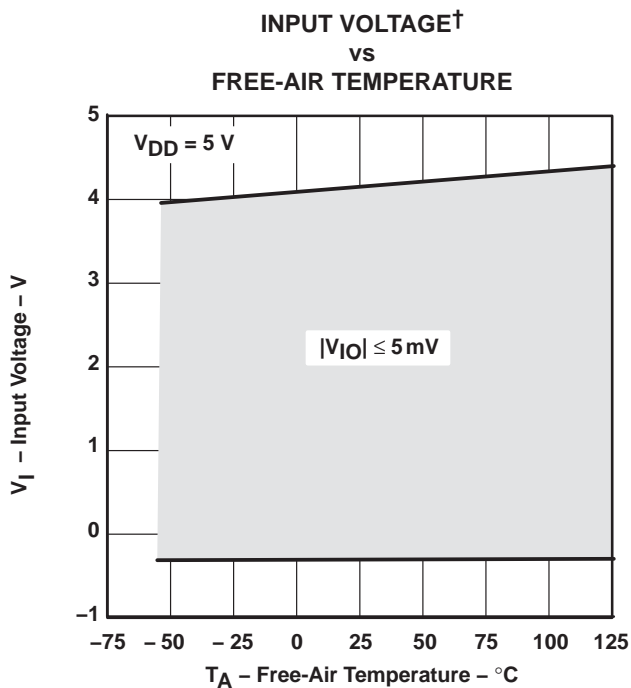

Figure 12

† Data at high and low temperatures are applicable only within the rated operating free-air temperature ranges of the various devices.

**TYPICAL CHARACTERISTICS**



**Figure 13**

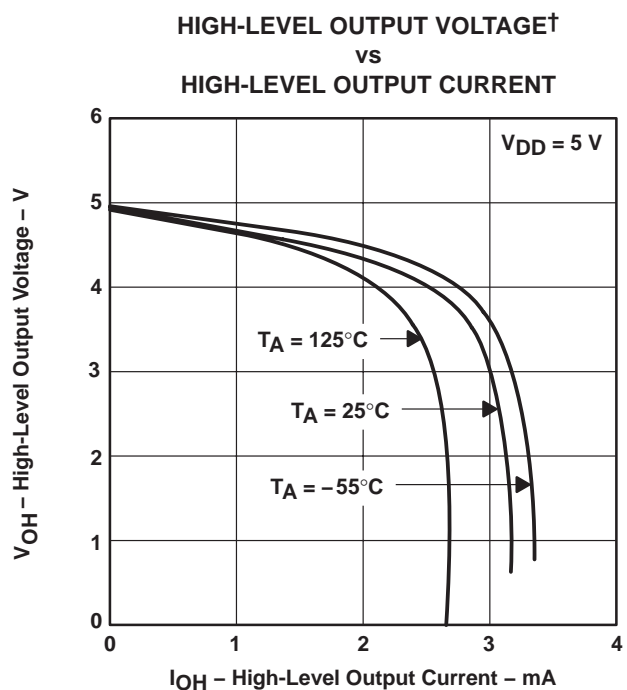

**Figure 14**

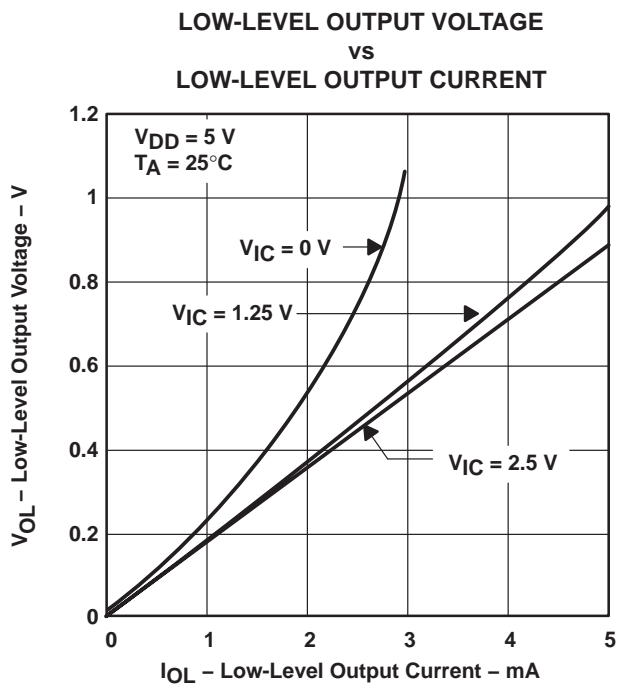

**Figure 15**

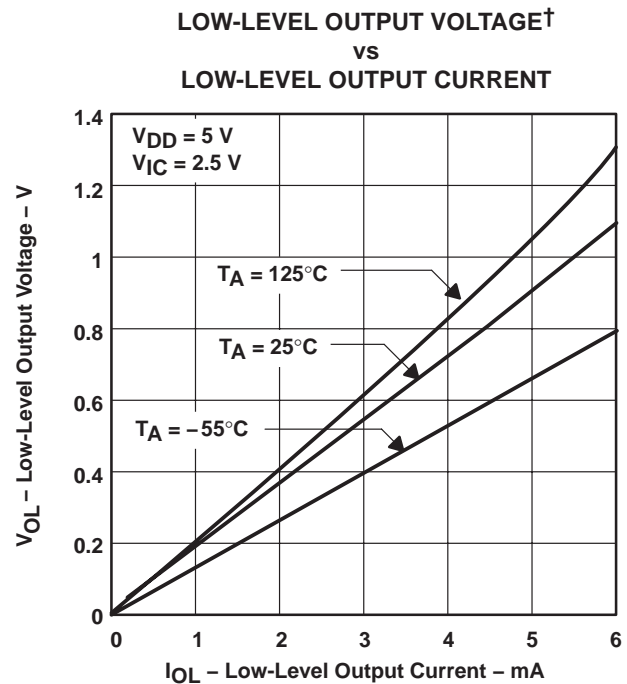

**Figure 16**

† Data at high and low temperatures are applicable only within the rated operating free-air temperature ranges of the various devices.

TYPICAL CHARACTERISTICS

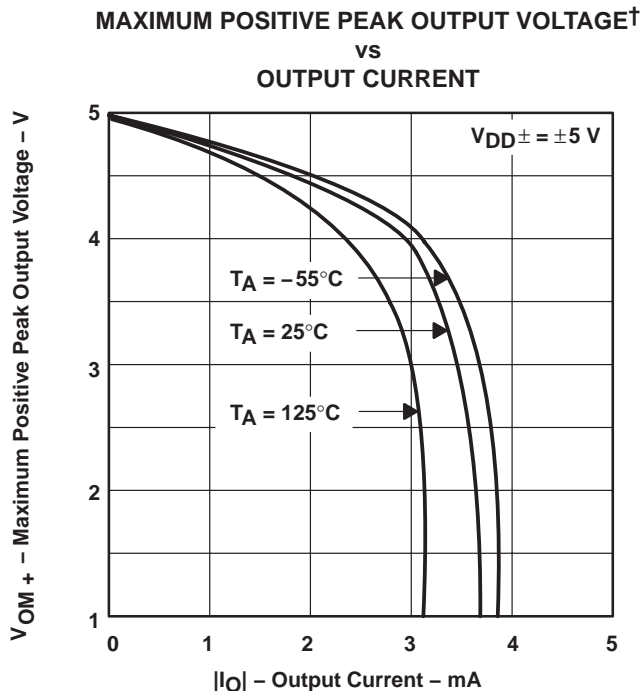

Figure 17

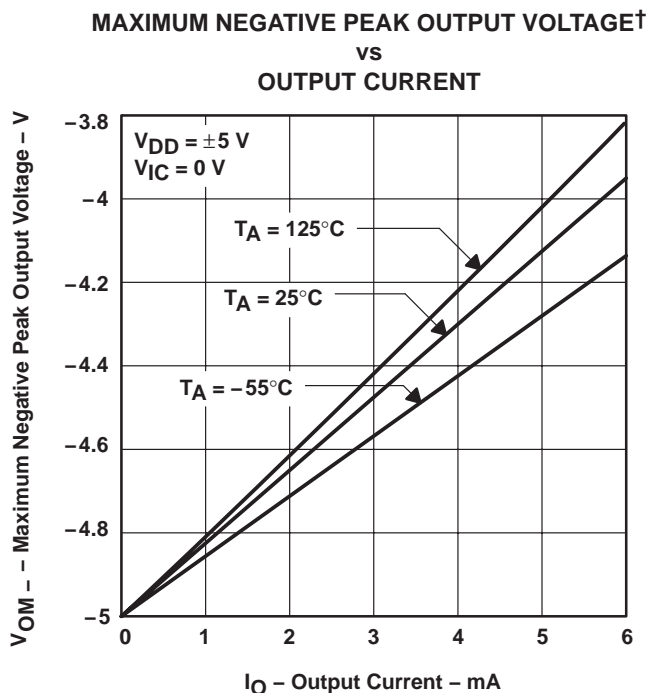

Figure 18

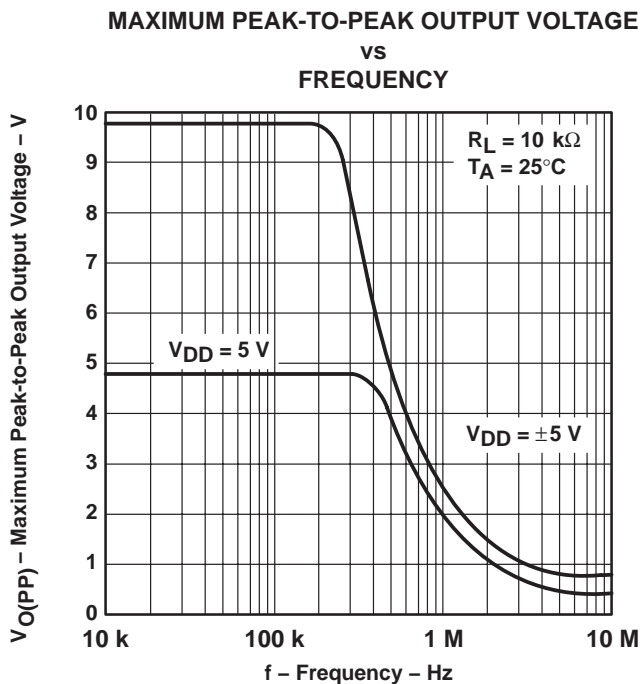

Figure 19

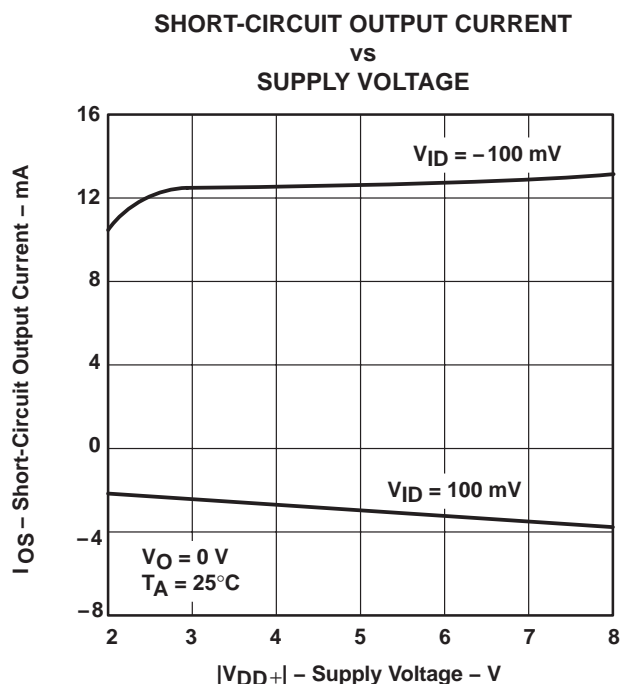
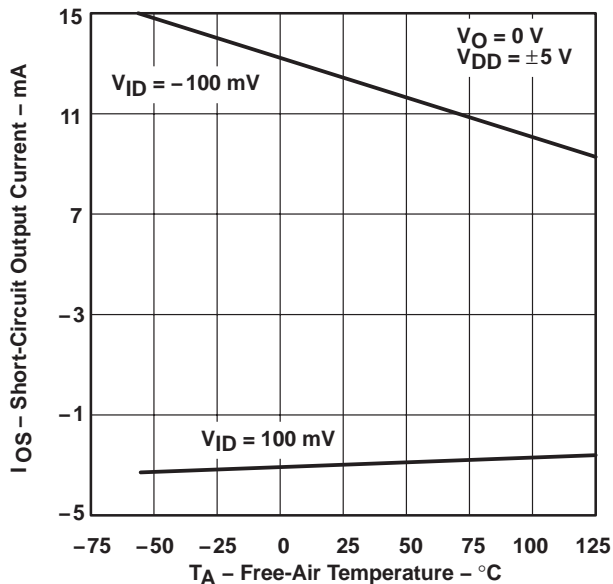

Figure 20

† Data at high and low temperatures are applicable only within the rated operating free-air temperature ranges of the various devices.

**TYPICAL CHARACTERISTICS**

**SHORT-CIRCUIT OUTPUT CURRENT†**  
**vs**  
**FREE-AIR TEMPERATURE**



**Figure 21**

**OUTPUT VOLTAGE**  
**vs**  
**DIFFERENTIAL INPUT VOLTAGE**

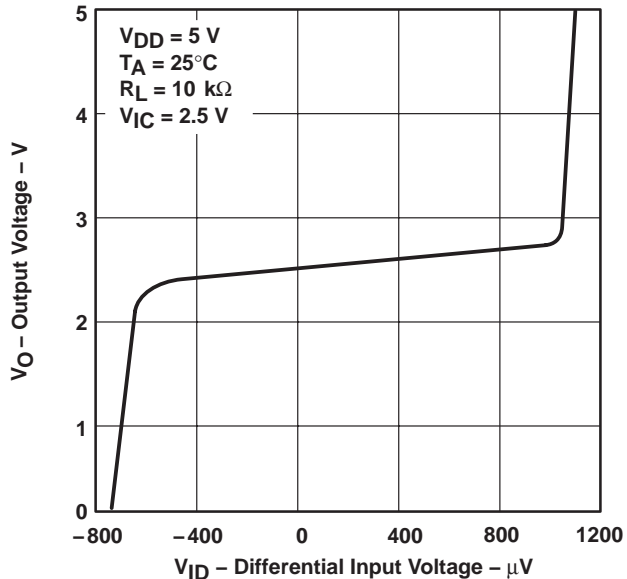

**Figure 22**

**OUTPUT VOLTAGE**  
**vs**  
**DIFFERENTIAL INPUT VOLTAGE**

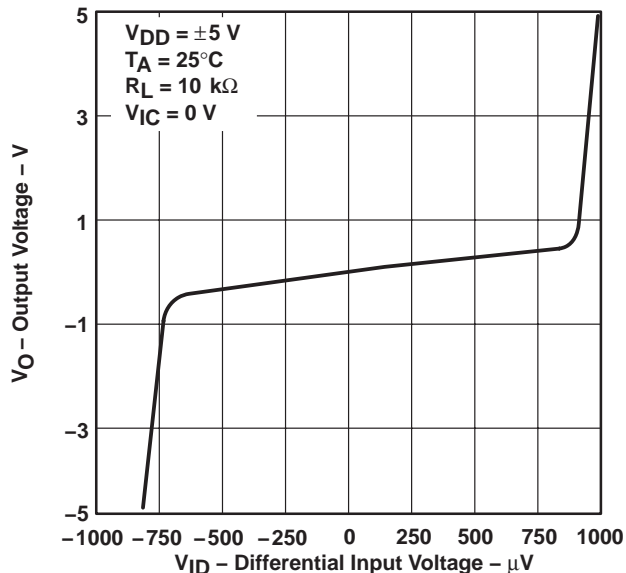

**Figure 23**

**LARGE-SIGNAL DIFFERENTIAL**  
**VOLTAGE AMPLIFICATION**  
**vs**  
**LOAD RESISTANCE**

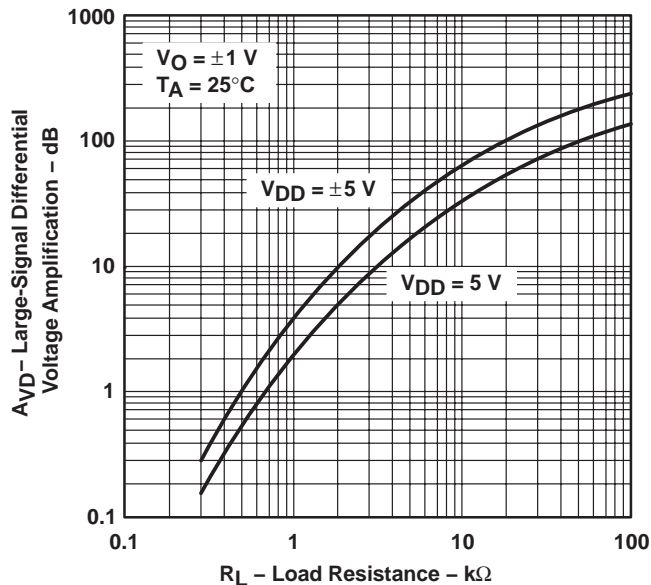

**Figure 24**

† Data at high and low temperatures are applicable only within the rated operating free-air temperature ranges of the various devices.

TYPICAL CHARACTERISTICS

LARGE-SIGNAL DIFFERENTIAL VOLTAGE  
 AMPLIFICATION AND PHASE MARGIN  
 vs  
 FREQUENCY

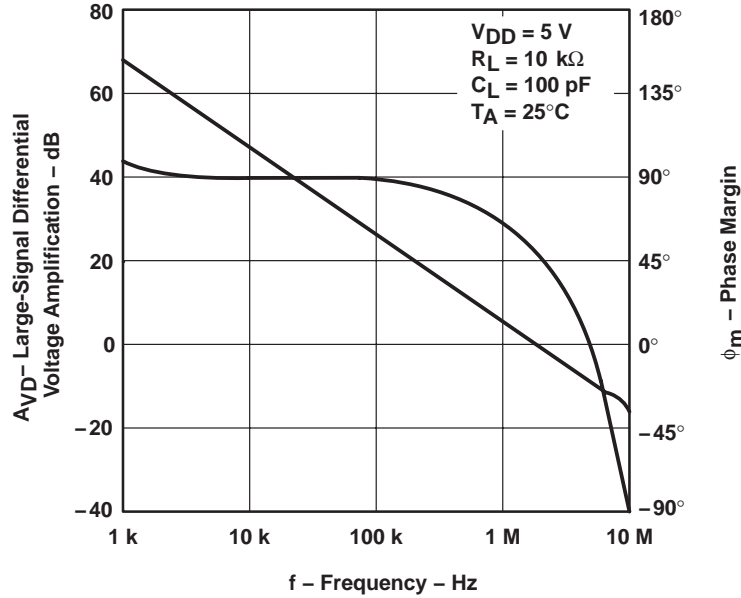

Figure 25

LARGE-SIGNAL DIFFERENTIAL VOLTAGE  
 AMPLIFICATION AND PHASE MARGIN  
 vs  
 FREQUENCY

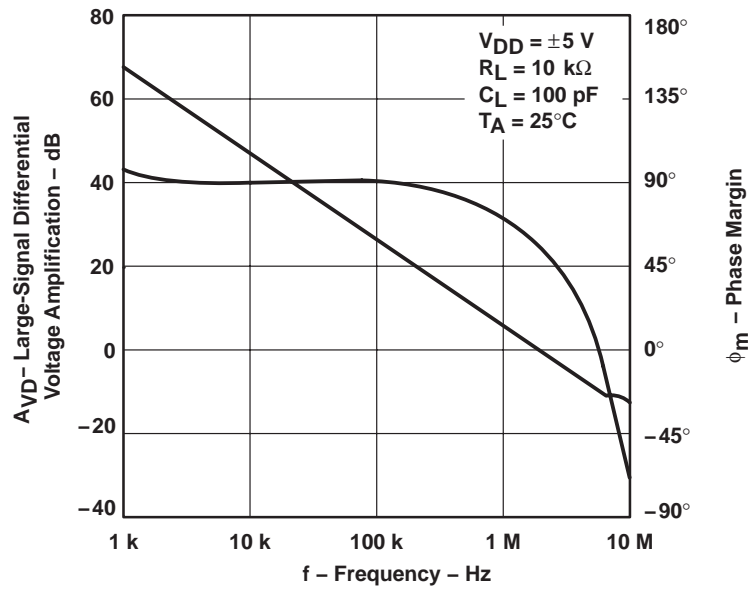
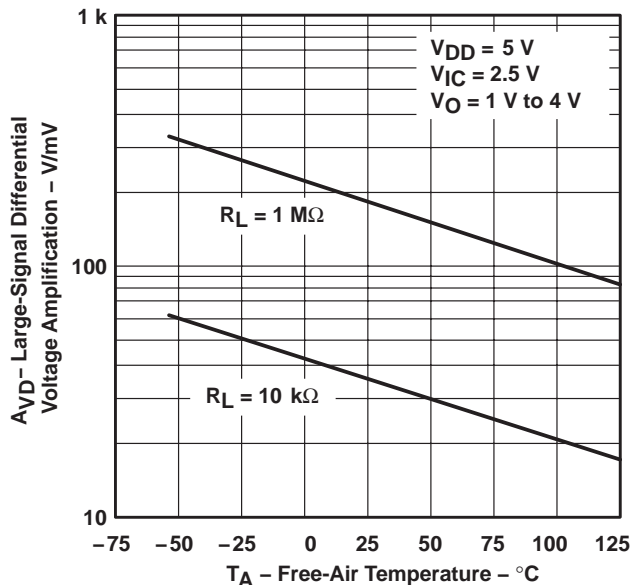

Figure 26

**TYPICAL CHARACTERISTICS**

**LARGE-SIGNAL DIFFERENTIAL VOLTAGE AMPLIFICATION†**  
**vs**  
**FREE-AIR TEMPERATURE**



**Figure 27**

**LARGE-SIGNAL DIFFERENTIAL VOLTAGE AMPLIFICATION†**  
**vs**  
**FREE-AIR TEMPERATURE**

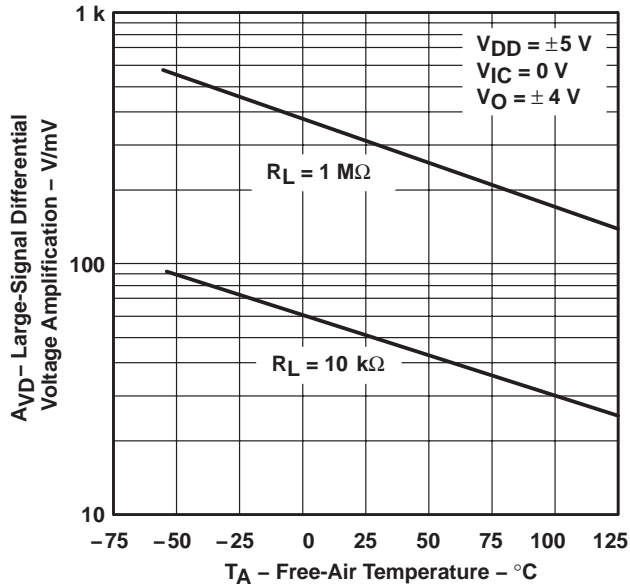

**Figure 28**

**OUTPUT IMPEDANCE**  
**vs**  
**FREQUENCY**

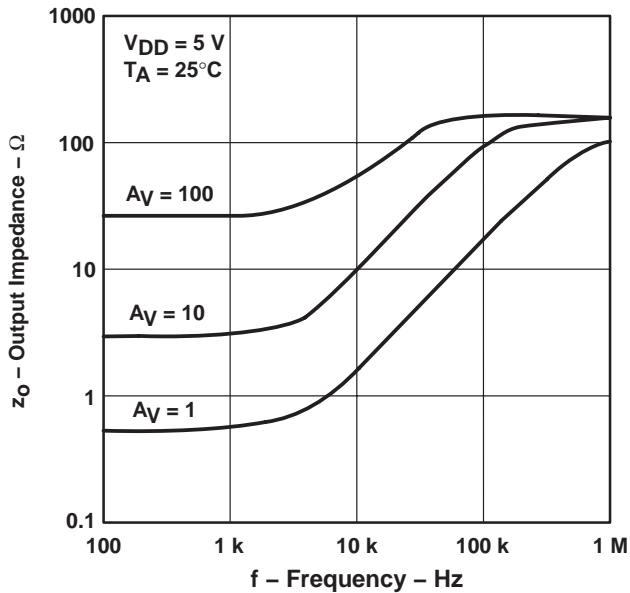

**Figure 29**

**OUTPUT IMPEDANCE**  
**vs**  
**FREQUENCY**

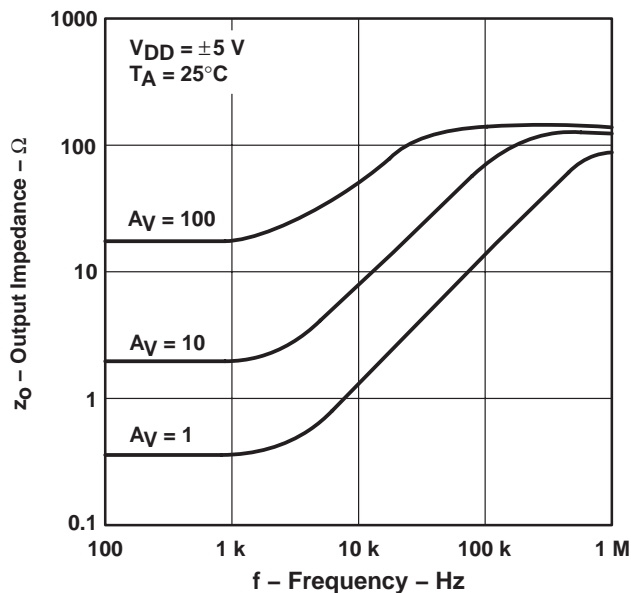

**Figure 30**

† Data at high and low temperatures are applicable only within the rated operating free-air temperature ranges of the various devices.

TYPICAL CHARACTERISTICS

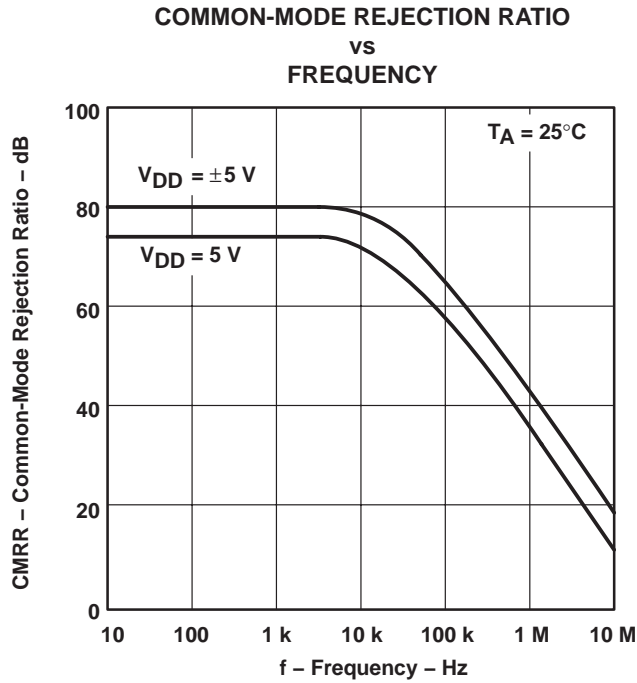

Figure 31

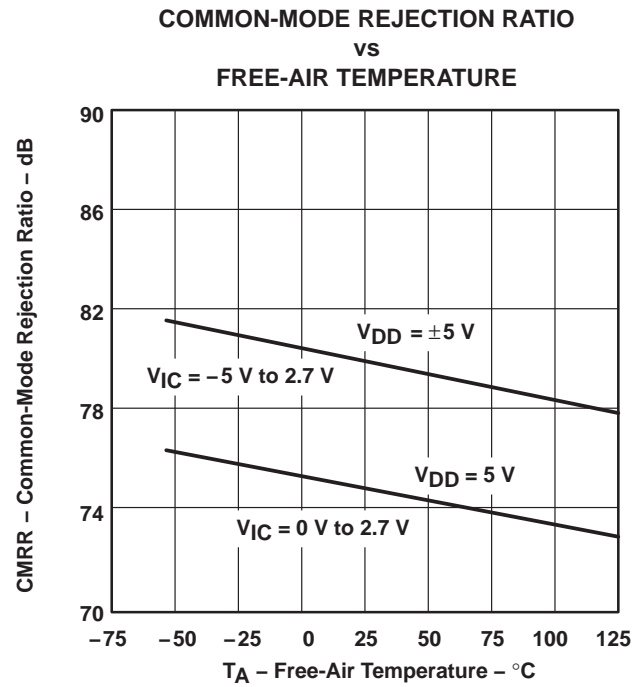

Figure 32

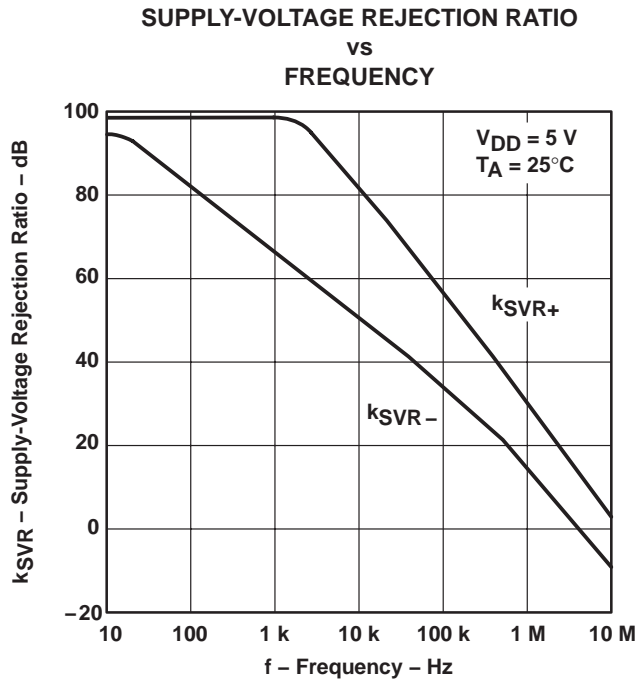

Figure 33

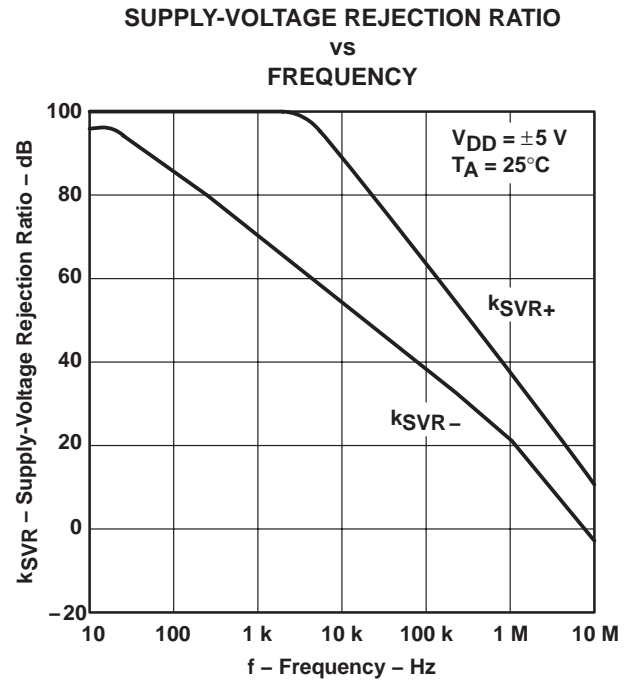
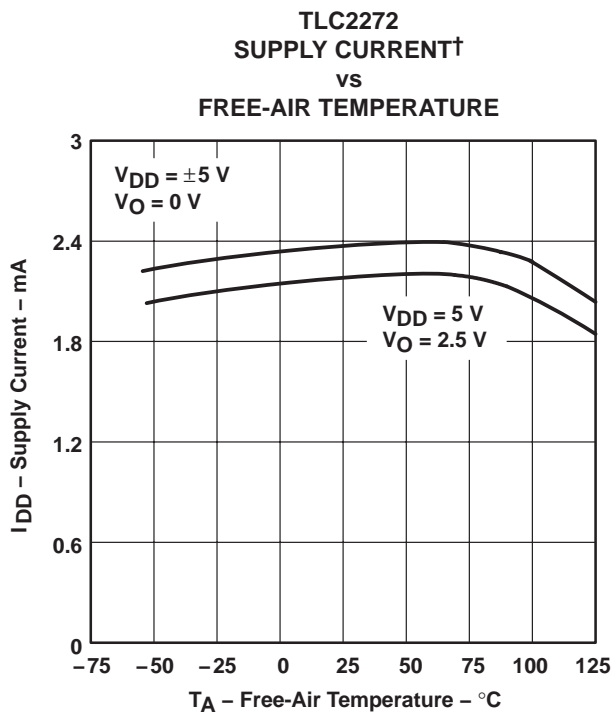
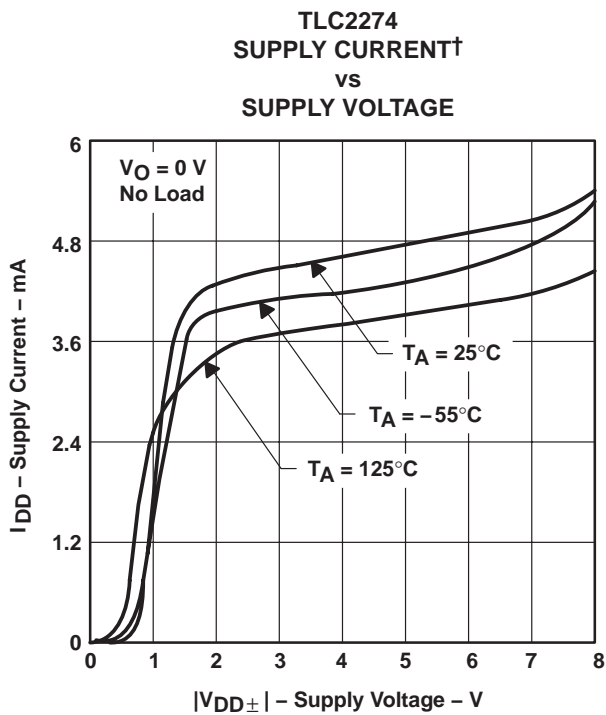
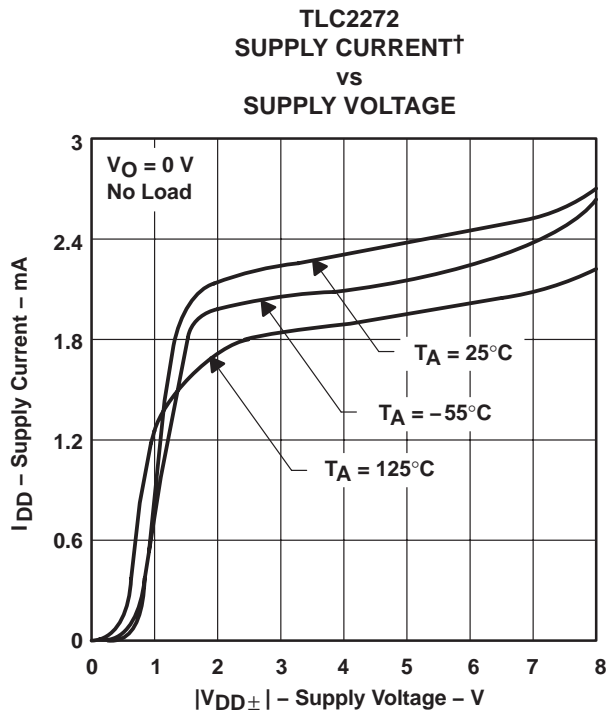
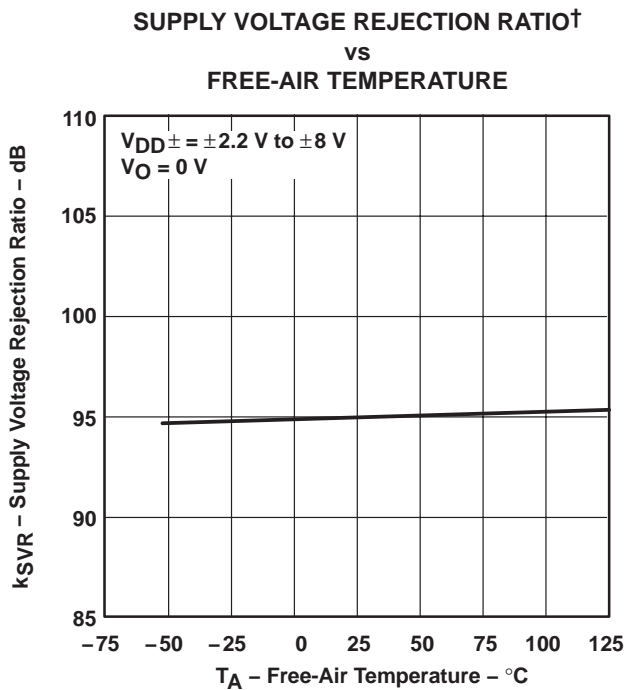

Figure 34

**TYPICAL CHARACTERISTICS**



† Data at high and low temperatures are applicable only within the rated operating free-air temperature ranges of the various devices.

TYPICAL CHARACTERISTICS

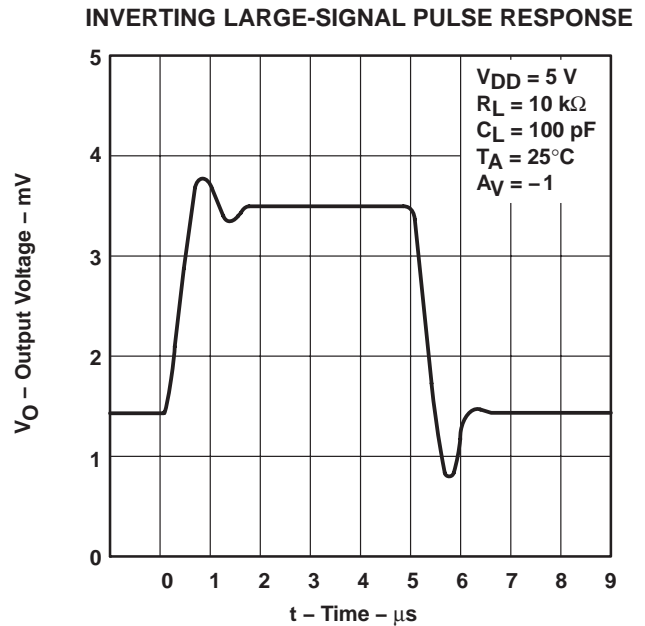
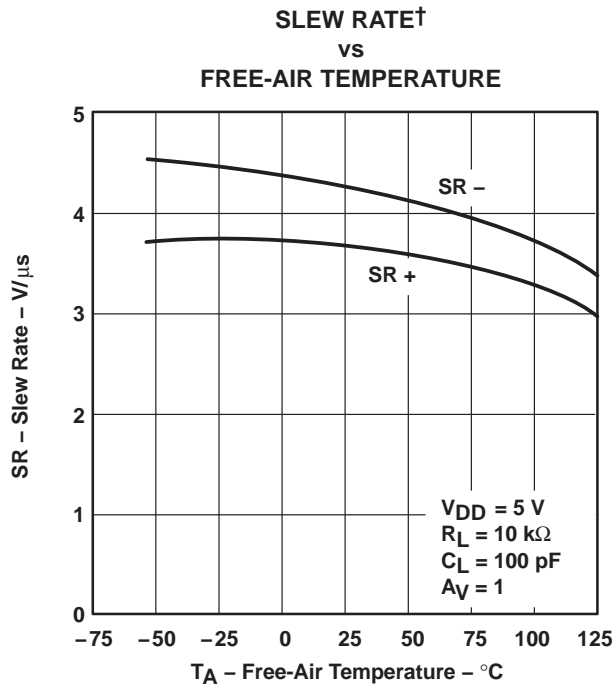
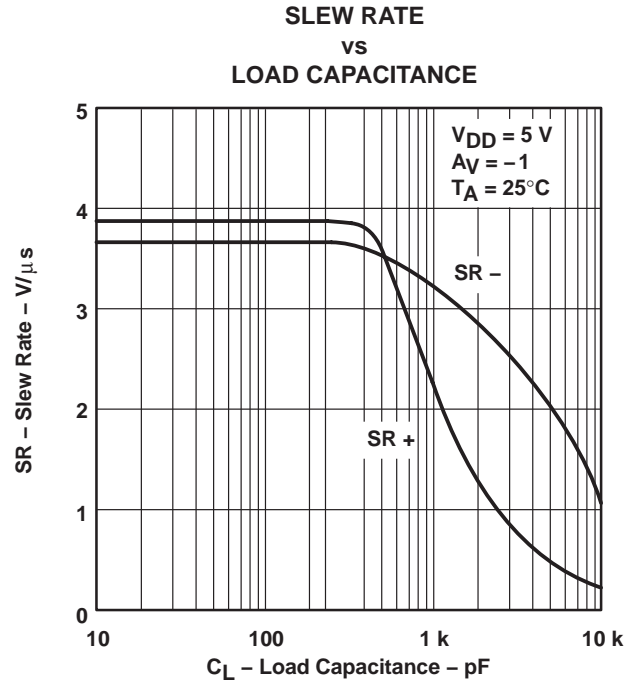
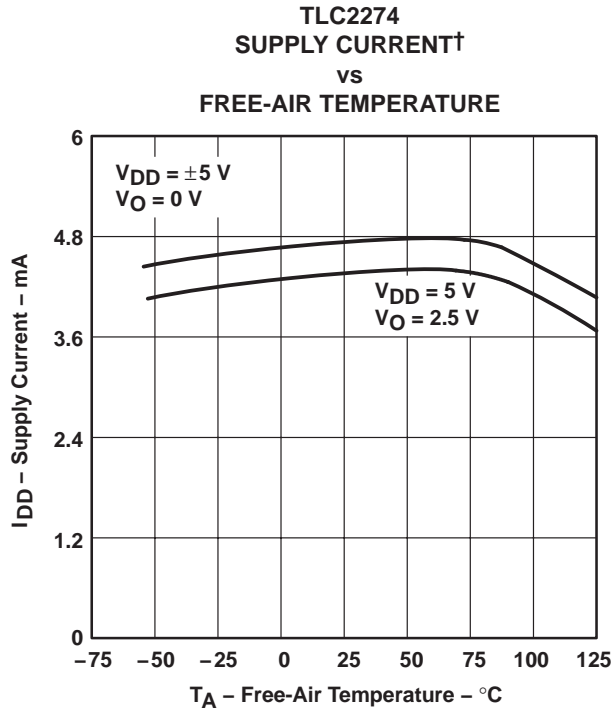

† Data at high and low temperatures are applicable only within the rated operating free-air temperature ranges of the various devices.

**TYPICAL CHARACTERISTICS**

**INVERTING LARGE-SIGNAL PULSE RESPONSE**

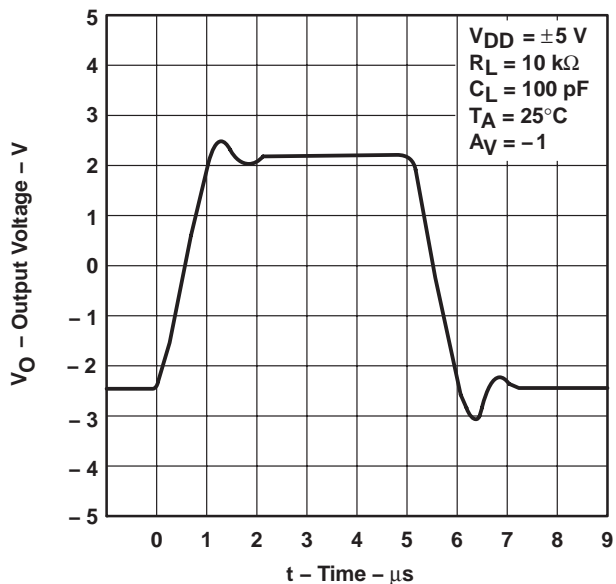

**Figure 43**

**VOLTAGE-FOLLOWER  
 LARGE-SIGNAL PULSE RESPONSE**

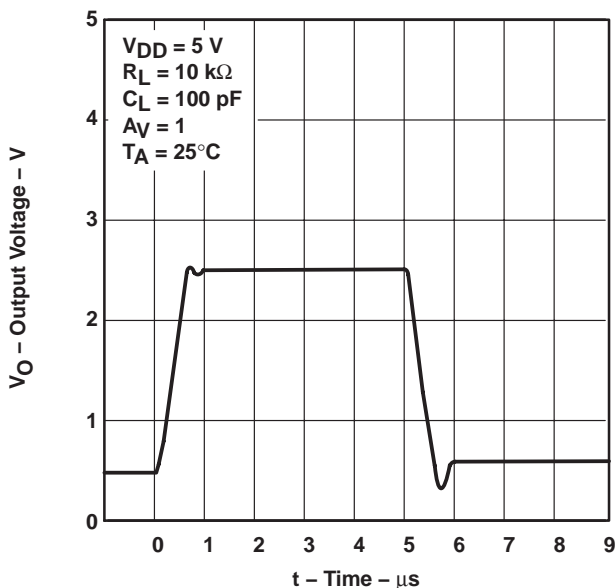

**Figure 44**

**VOLTAGE-FOLLOWER  
 LARGE-SIGNAL PULSE RESPONSE**

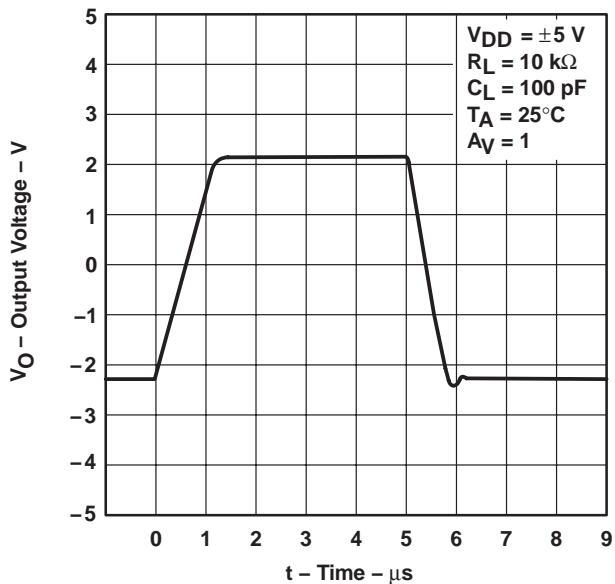

**Figure 45**

**INVERTING SMALL-SIGNAL PULSE RESPONSE**

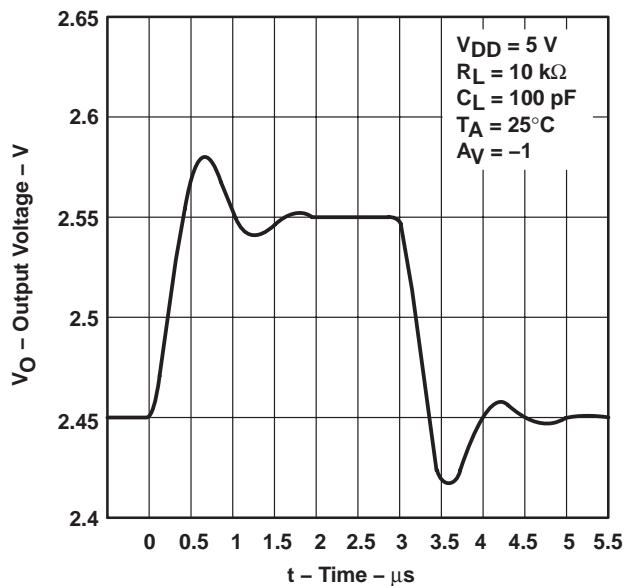

**Figure 46**

TYPICAL CHARACTERISTICS

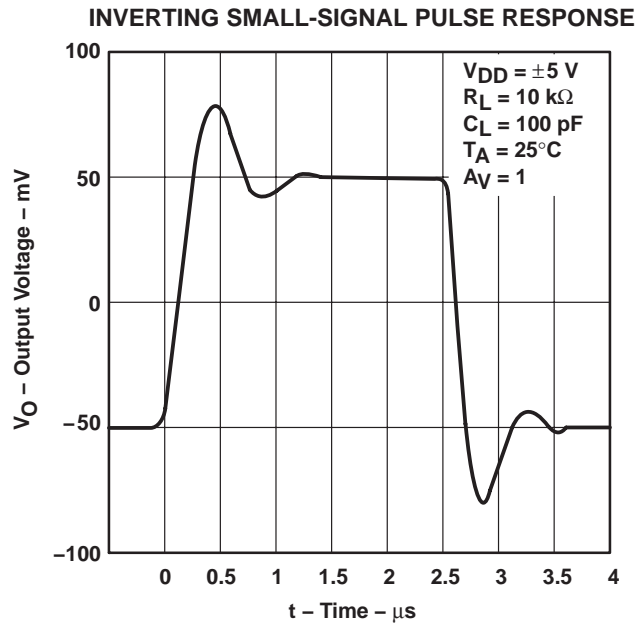

Figure 47

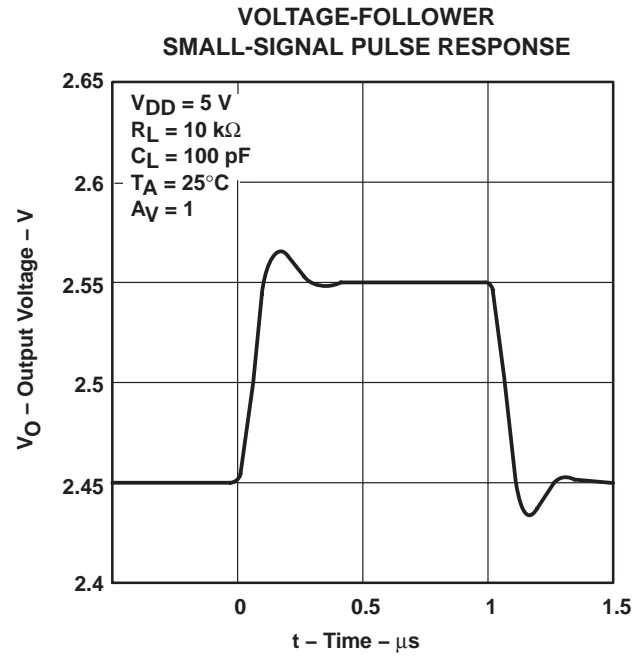

Figure 48

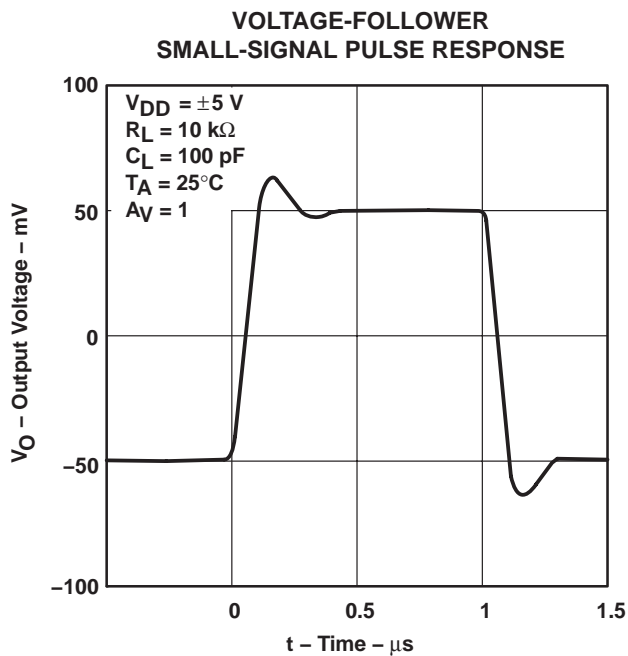

Figure 49

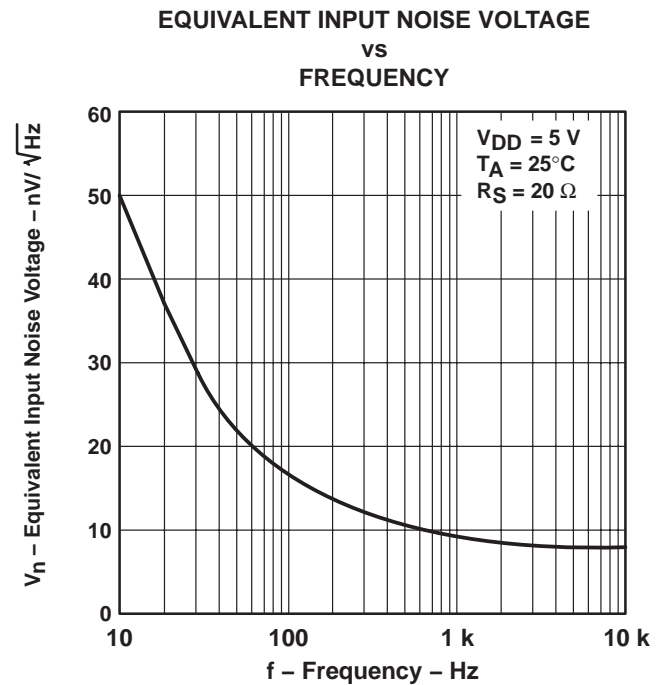
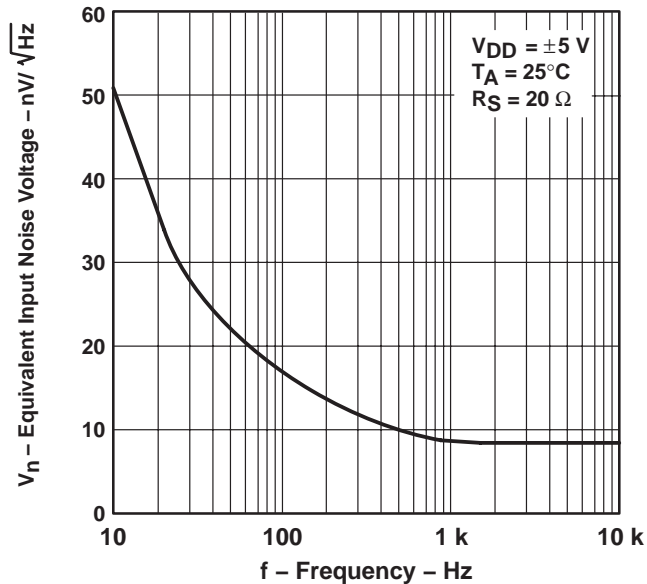

Figure 50

**TYPICAL CHARACTERISTICS**

**EQUIVALENT INPUT NOISE VOLTAGE  
 vs  
 FREQUENCY**



**Figure 51**

**NOISE VOLTAGE  
 OVER A 10 SECOND PERIOD**

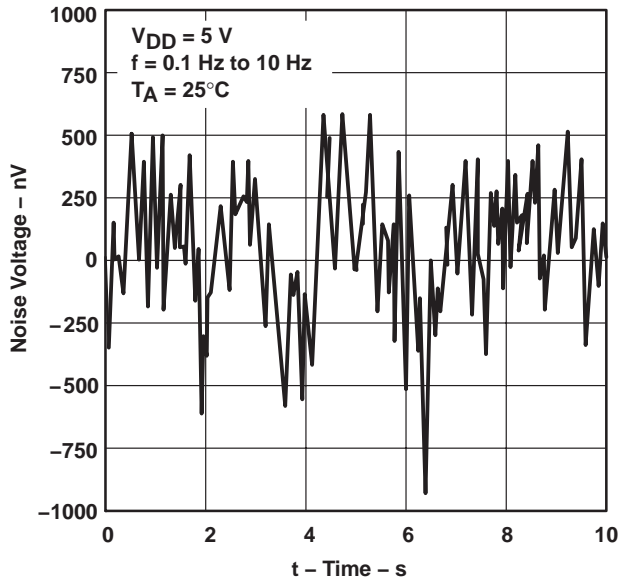

**Figure 52**

**INTEGRATED NOISE VOLTAGE  
 vs  
 FREQUENCY**

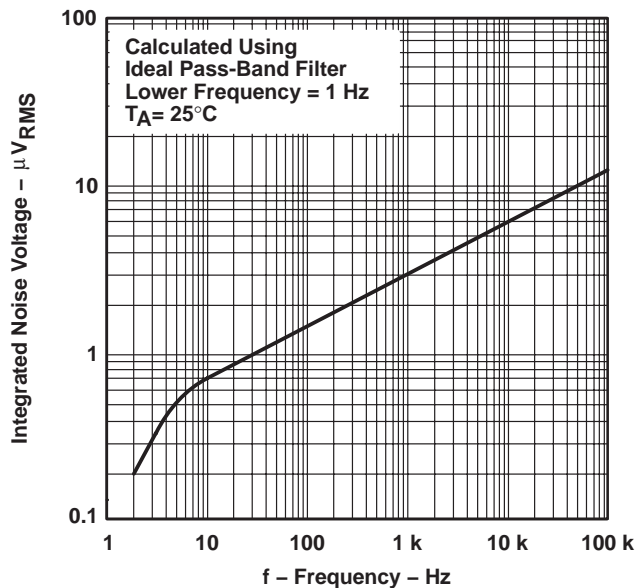

**Figure 53**

**TOTAL HARMONIC DISTORTION PLUS NOISE  
 vs  
 FREQUENCY**

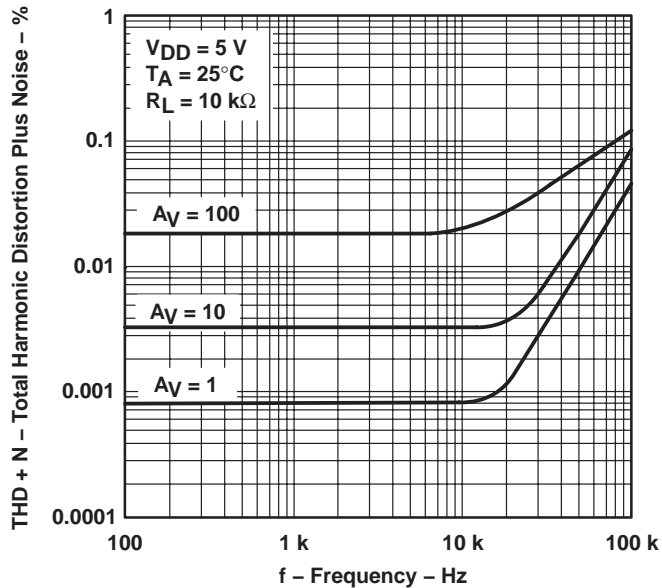

**Figure 54**

TYPICAL CHARACTERISTICS

GAIN-BANDWIDTH PRODUCT  
VS  
SUPPLY VOLTAGE

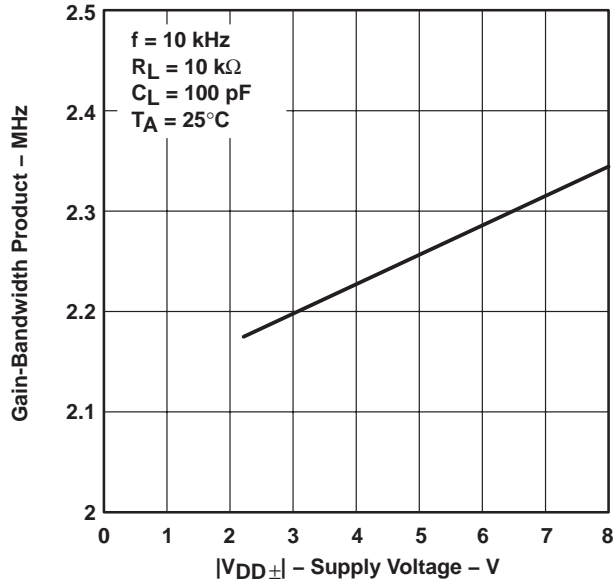

Figure 55

GAIN-BANDWIDTH PRODUCT†  
VS  
FREE-AIR TEMPERATURE

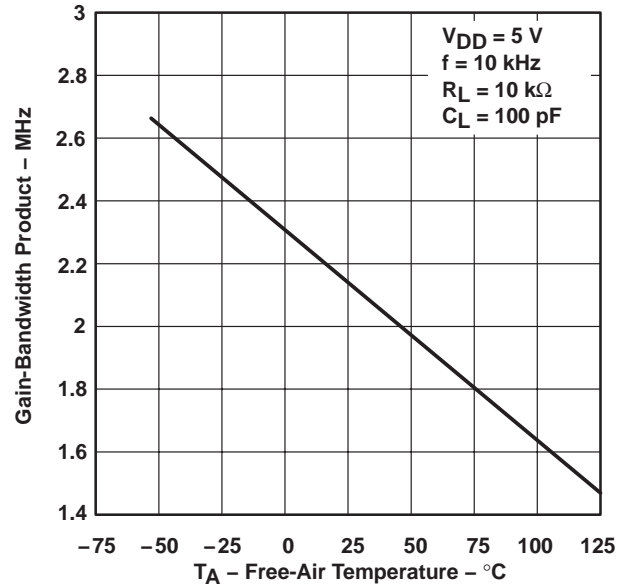

Figure 56

PHASE MARGIN  
VS  
LOAD CAPACITANCE

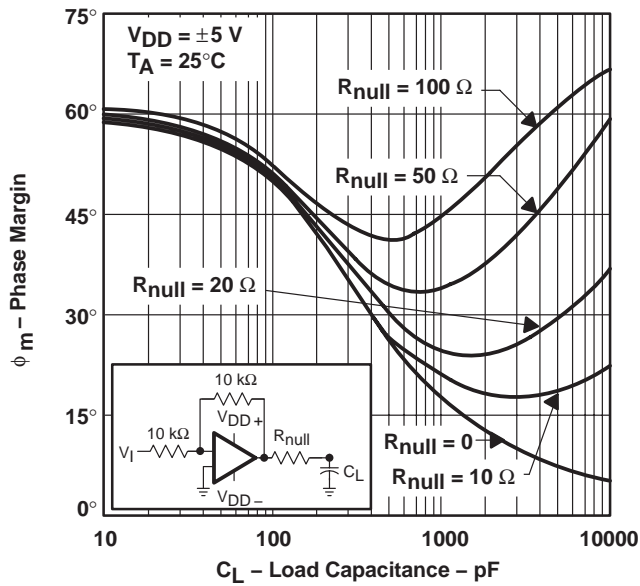

Figure 57

GAIN MARGIN  
VS  
LOAD CAPACITANCE

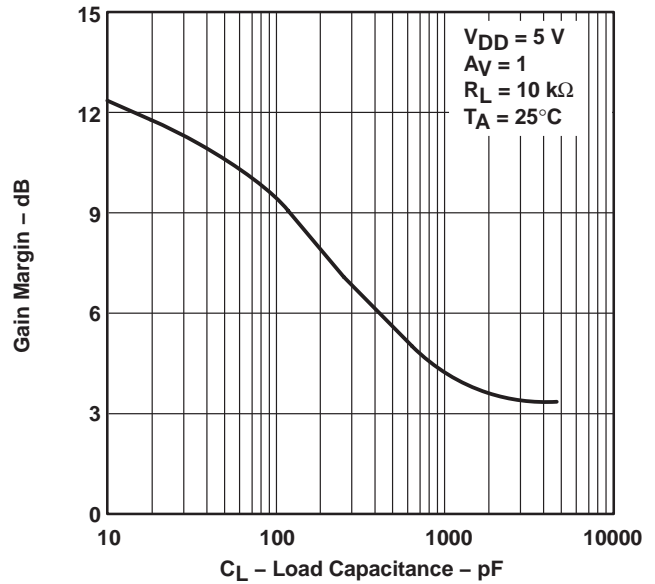

Figure 58

† Data at high and low temperatures are applicable only within the rated operating free-air temperature ranges of the various devices.

# TLC227x, TLC227xA Advanced LinCMOS™ RAIL-TO-RAIL OPERATIONAL AMPLIFIERS

SLOS190G – FEBRUARY 1997 – REVISED MAY 2004

## APPLICATION INFORMATION

### macromodel information

Macromodel information provided was derived using Microsim *Parts*™, the model generation software used with Microsim *PSpice*™. The Boyle macromodel (see Note 5) and subcircuit in Figure 59 were generated using the TLC227x typical electrical and operating characteristics at  $T_A = 25^\circ\text{C}$ . Using this information, output simulations of the following key parameters can be generated to a tolerance of 20% (in most cases):

- Maximum positive output voltage swing
- Maximum negative output voltage swing
- Slew rate
- Quiescent power dissipation
- Input bias current
- Open-loop voltage amplification
- Unity gain frequency
- Common-mode rejection ratio
- Phase margin
- DC output resistance
- AC output resistance
- Short-circuit output current limit

NOTE 5: G. R. Boyle, B. M. Cohn, D. O. Pederson, and J. E. Solomon, "Macromodeling of Integrated Circuit Operational Amplifiers", *IEEE Journal of Solid-State Circuits*, SC-9, 353 (1974).

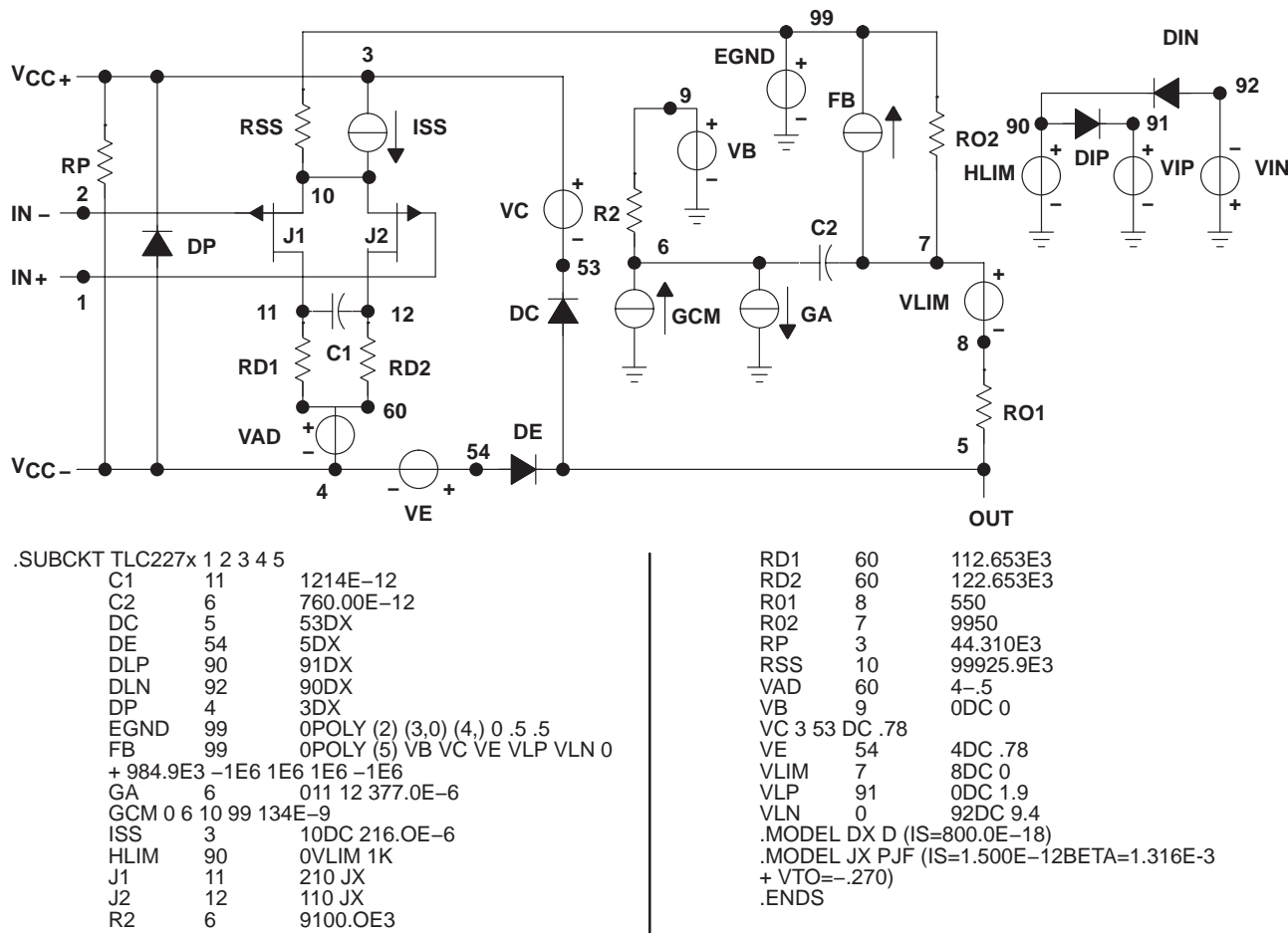

Figure 59. Boyle Macromodel and Subcircuit

*PSpice* and *Parts* are trademarks of MicroSim Corporation.

Macromodels, simulation models, or other models provided by TI, directly or indirectly, are not warranted by TI as fully representing all of the specification and operating characteristics of the semiconductor product to which the model relates.



POST OFFICE BOX 655303 • DALLAS, TEXAS 75265

**PACKAGING INFORMATION**

Orderable Device	Status <sup>(1)</sup>	Package Type	Package Drawing	Pins	Package Qty	Eco Plan <sup>(2)</sup>	Lead/ Ball Finish	MSL Peak Temp <sup>(3)</sup>	Samples (Requires Login)
5962-9318201M2A	ACTIVE	LCCC	FK	20	1	TBD	POST-PLATE	N / A for Pkg Type	Contact TI Distributor or Sales Office
5962-9318201MCA	ACTIVE	CDIP	J	14	1	TBD	A42	N / A for Pkg Type	Contact TI Distributor or Sales Office
5962-9318201QDA	ACTIVE	CFP	W	14	1	TBD	A42	N / A for Pkg Type	Contact TI Distributor or Sales Office
5962-9318202Q2A	ACTIVE	LCCC	FK	20	1	TBD	POST-PLATE	N / A for Pkg Type	Contact TI Distributor or Sales Office
5962-9318202QCA	ACTIVE	CDIP	J	14	1	TBD	A42	N / A for Pkg Type	Contact TI Distributor or Sales Office
5962-9318202QDA	ACTIVE	CFP	W	14	1	TBD	A42	N / A for Pkg Type	Contact TI Distributor or Sales Office
5962-9555201NXD	ACTIVE	SOIC	D	8	2500	Green (RoHS & no Sb/Br)	CU NIPDAU	Level-1-260C-UNLIM	Contact TI Distributor or Sales Office
5962-9555201NXDR	ACTIVE	SOIC	D	8	2500	Green (RoHS & no Sb/Br)	CU NIPDAU	Level-1-260C-UNLIM	Contact TI Distributor or Sales Office
5962-9555201Q2A	ACTIVE	LCCC	FK	20	1	TBD	POST-PLATE	N / A for Pkg Type	<a href="#">Purchase Samples</a>
5962-9555201QHA	ACTIVE	CFP	U	10	1	TBD	A42	N / A for Pkg Type	<a href="#">Purchase Samples</a>
5962-9555201QPA	ACTIVE	CDIP	JG	8	1	TBD	A42	N / A for Pkg Type	<a href="#">Purchase Samples</a>
5962-9555202Q2A	ACTIVE	LCCC	FK	20	1	TBD	POST-PLATE	N / A for Pkg Type	<a href="#">Purchase Samples</a>
5962-9555202QHA	ACTIVE	CFP	U	10	1	TBD	A42	N / A for Pkg Type	<a href="#">Purchase Samples</a>
5962-9555202QPA	ACTIVE	CDIP	JG	8	1	TBD	A42	N / A for Pkg Type	<a href="#">Purchase Samples</a>
TLC2272ACD	ACTIVE	SOIC	D	8	75	Green (RoHS & no Sb/Br)	CU NIPDAU	Level-1-260C-UNLIM	<a href="#">Request Free Samples</a>
TLC2272ACDG4	ACTIVE	SOIC	D	8	75	Green (RoHS & no Sb/Br)	CU NIPDAU	Level-1-260C-UNLIM	<a href="#">Request Free Samples</a>
TLC2272ACDR	ACTIVE	SOIC	D	8	2500	Green (RoHS & no Sb/Br)	CU NIPDAU	Level-1-260C-UNLIM	<a href="#">Purchase Samples</a>
TLC2272ACDRG4	ACTIVE	SOIC	D	8	2500	Green (RoHS & no Sb/Br)	CU NIPDAU	Level-1-260C-UNLIM	<a href="#">Purchase Samples</a>
TLC2272ACP	ACTIVE	PDIP	P	8	50	Pb-Free (RoHS)	CU NIPDAU	N / A for Pkg Type	<a href="#">Request Free Samples</a>
TLC2272ACPE4	ACTIVE	PDIP	P	8	50	Pb-Free (RoHS)	CU NIPDAU	N / A for Pkg Type	<a href="#">Request Free Samples</a>

Orderable Device	Status <sup>(1)</sup>	Package Type	Package Drawing	Pins	Package Qty	Eco Plan <sup>(2)</sup>	Lead/ Ball Finish	MSL Peak Temp <sup>(3)</sup>	Samples (Requires Login)
TLC2272ACPW	ACTIVE	TSSOP	PW	8	150	Green (RoHS & no Sb/Br)	CU NIPDAU	Level-1-260C-UNLIM	Contact TI Distributor or Sales Office
TLC2272ACPWG4	ACTIVE	TSSOP	PW	8	150	Green (RoHS & no Sb/Br)	CU NIPDAU	Level-1-260C-UNLIM	Contact TI Distributor or Sales Office
TLC2272ACPWLE	OBSOLETE	TSSOP	PW	8		TBD	Call TI	Call TI	Samples Not Available
TLC2272ACPWR	ACTIVE	TSSOP	PW	8	2000	Green (RoHS & no Sb/Br)	CU NIPDAU	Level-1-260C-UNLIM	<a href="#">Request Free Samples</a>
TLC2272ACPWRG4	ACTIVE	TSSOP	PW	8	2000	Green (RoHS & no Sb/Br)	CU NIPDAU	Level-1-260C-UNLIM	<a href="#">Request Free Samples</a>
TLC2272AID	ACTIVE	SOIC	D	8	75	Green (RoHS & no Sb/Br)	CU NIPDAU	Level-1-260C-UNLIM	Contact TI Distributor or Sales Office
TLC2272AIDG4	ACTIVE	SOIC	D	8	75	Green (RoHS & no Sb/Br)	CU NIPDAU	Level-1-260C-UNLIM	Contact TI Distributor or Sales Office
TLC2272AIDR	ACTIVE	SOIC	D	8	2500	Green (RoHS & no Sb/Br)	CU NIPDAU	Level-1-260C-UNLIM	<a href="#">Request Free Samples</a>
TLC2272AIDRG4	ACTIVE	SOIC	D	8	2500	Green (RoHS & no Sb/Br)	CU NIPDAU	Level-1-260C-UNLIM	<a href="#">Request Free Samples</a>
TLC2272AIP	ACTIVE	PDIP	P	8	50	Pb-Free (RoHS)	CU NIPDAU	N / A for Pkg Type	<a href="#">Request Free Samples</a>
TLC2272AIPE4	ACTIVE	PDIP	P	8	50	Pb-Free (RoHS)	CU NIPDAU	N / A for Pkg Type	<a href="#">Request Free Samples</a>
TLC2272AMD	ACTIVE	SOIC	D	8	75	TBD	CU NIPDAU	Level-1-220C-UNLIM	<a href="#">Request Free Samples</a>
TLC2272AMDG4	ACTIVE	SOIC	D	8	75	Green (RoHS & no Sb/Br)	CU NIPDAU	Level-1-260C-UNLIM	<a href="#">Purchase Samples</a>
TLC2272AMDR	ACTIVE	SOIC	D	8	2500	TBD	CU NIPDAU	Level-1-220C-UNLIM	<a href="#">Purchase Samples</a>
TLC2272AMDRG4	ACTIVE	SOIC	D	8	2500	Green (RoHS & no Sb/Br)	CU NIPDAU	Level-1-260C-UNLIM	<a href="#">Purchase Samples</a>
TLC2272AMFKB	ACTIVE	LCCC	FK	20	1	TBD	POST-PLATE	N / A for Pkg Type	Contact TI Distributor or Sales Office
TLC2272AMJGB	ACTIVE	CDIP	JG	8	1	TBD	A42	N / A for Pkg Type	Contact TI Distributor or Sales Office
TLC2272AMP	OBSOLETE	PDIP	P	8		TBD	Call TI	Call TI	Samples Not Available
TLC2272AMUB	ACTIVE	CFP	U	10	1	TBD	A42	N / A for Pkg Type	Contact TI Distributor or Sales Office
TLC2272AQD	ACTIVE	SOIC	D	8	75	Green (RoHS & no Sb/Br)	CU NIPDAU	Level-1-260C-UNLIM	<a href="#">Purchase Samples</a>

Orderable Device	Status <sup>(1)</sup>	Package Type	Package Drawing	Pins	Package Qty	Eco Plan <sup>(2)</sup>	Lead/ Ball Finish	MSL Peak Temp <sup>(3)</sup>	Samples (Requires Login)
TLC2272AQDG4	ACTIVE	SOIC	D	8	75	Green (RoHS & no Sb/Br)	CU NIPDAU	Level-1-260C-UNLIM	<a href="#">Purchase Samples</a>
TLC2272AQDR	ACTIVE	SOIC	D	8	2500	Green (RoHS & no Sb/Br)	CU NIPDAU	Level-1-260C-UNLIM	<a href="#">Purchase Samples</a>
TLC2272AQDRG4	ACTIVE	SOIC	D	8	2500	Green (RoHS & no Sb/Br)	CU NIPDAU	Level-1-260C-UNLIM	<a href="#">Purchase Samples</a>
TLC2272CD	ACTIVE	SOIC	D	8	75	Green (RoHS & no Sb/Br)	CU NIPDAU	Level-1-260C-UNLIM	<a href="#">Request Free Samples</a>
TLC2272CDG4	ACTIVE	SOIC	D	8	75	Green (RoHS & no Sb/Br)	CU NIPDAU	Level-1-260C-UNLIM	<a href="#">Request Free Samples</a>
TLC2272CDR	ACTIVE	SOIC	D	8	2500	Green (RoHS & no Sb/Br)	CU NIPDAU	Level-1-260C-UNLIM	<a href="#">Purchase Samples</a>
TLC2272CDRG4	ACTIVE	SOIC	D	8	2500	Green (RoHS & no Sb/Br)	CU NIPDAU	Level-1-260C-UNLIM	<a href="#">Purchase Samples</a>
TLC2272CP	ACTIVE	PDIP	P	8	50	Pb-Free (RoHS)	CU NIPDAU	N / A for Pkg Type	<a href="#">Request Free Samples</a>
TLC2272CPE4	ACTIVE	PDIP	P	8	50	Pb-Free (RoHS)	CU NIPDAU	N / A for Pkg Type	<a href="#">Request Free Samples</a>
TLC2272CPSR	ACTIVE	SO	PS	8	2000	Green (RoHS & no Sb/Br)	CU NIPDAU	Level-1-260C-UNLIM	<a href="#">Purchase Samples</a>
TLC2272CPSRG4	ACTIVE	SO	PS	8	2000	Green (RoHS & no Sb/Br)	CU NIPDAU	Level-1-260C-UNLIM	<a href="#">Purchase Samples</a>
TLC2272CPW	ACTIVE	TSSOP	PW	8	150	Green (RoHS & no Sb/Br)	CU NIPDAU	Level-1-260C-UNLIM	Contact TI Distributor or Sales Office
TLC2272CPWG4	ACTIVE	TSSOP	PW	8	150	Green (RoHS & no Sb/Br)	CU NIPDAU	Level-1-260C-UNLIM	Contact TI Distributor or Sales Office
TLC2272CPWLE	OBSOLETE	TSSOP	PW	8		TBD	Call TI	Call TI	Replaced by TLC2272CPWR
TLC2272CPWR	ACTIVE	TSSOP	PW	8	2000	Green (RoHS & no Sb/Br)	CU NIPDAU	Level-1-260C-UNLIM	<a href="#">Request Free Samples</a>
TLC2272CPWRG4	ACTIVE	TSSOP	PW	8	2000	Green (RoHS & no Sb/Br)	CU NIPDAU	Level-1-260C-UNLIM	<a href="#">Request Free Samples</a>
TLC2272ID	ACTIVE	SOIC	D	8	75	Green (RoHS & no Sb/Br)	CU NIPDAU	Level-1-260C-UNLIM	<a href="#">Request Free Samples</a>
TLC2272IDG4	ACTIVE	SOIC	D	8	75	Green (RoHS & no Sb/Br)	CU NIPDAU	Level-1-260C-UNLIM	<a href="#">Request Free Samples</a>
TLC2272IDR	ACTIVE	SOIC	D	8	2500	Green (RoHS & no Sb/Br)	CU NIPDAU	Level-1-260C-UNLIM	<a href="#">Purchase Samples</a>

Orderable Device	Status <sup>(1)</sup>	Package Type	Package Drawing	Pins	Package Qty	Eco Plan <sup>(2)</sup>	Lead/ Ball Finish	MSL Peak Temp <sup>(3)</sup>	Samples (Requires Login)
TLC2272IDRG4	ACTIVE	SOIC	D	8	2500	Green (RoHS & no Sb/Br)	CU NIPDAU	Level-1-260C-UNLIM	<a href="#">Purchase Samples</a>
TLC2272IP	ACTIVE	PDIP	P	8	50	Pb-Free (RoHS)	CU NIPDAU	N / A for Pkg Type	<a href="#">Request Free Samples</a>
TLC2272IPE4	ACTIVE	PDIP	P	8	50	Pb-Free (RoHS)	CU NIPDAU	N / A for Pkg Type	<a href="#">Request Free Samples</a>
TLC2272IPW	ACTIVE	TSSOP	PW	8	150	Green (RoHS & no Sb/Br)	CU NIPDAU	Level-1-260C-UNLIM	Contact TI Distributor or Sales Office
TLC2272IPWG4	ACTIVE	TSSOP	PW	8	150	Green (RoHS & no Sb/Br)	CU NIPDAU	Level-1-260C-UNLIM	Contact TI Distributor or Sales Office
TLC2272IPWLE	OBSOLETE	TSSOP	PW	8		TBD	Call TI	Call TI	Samples Not Available
TLC2272IPWR	ACTIVE	TSSOP	PW	8	2000	Green (RoHS & no Sb/Br)	CU NIPDAU	Level-1-260C-UNLIM	<a href="#">Request Free Samples</a>
TLC2272IPWRG4	ACTIVE	TSSOP	PW	8	2000	Green (RoHS & no Sb/Br)	CU NIPDAU	Level-1-260C-UNLIM	<a href="#">Request Free Samples</a>
TLC2272MD	ACTIVE	SOIC	D	8	75	TBD	CU NIPDAU	Level-1-220C-UNLIM	Contact TI Distributor or Sales Office
TLC2272MDG4	ACTIVE	SOIC	D	8	75	Green (RoHS & no Sb/Br)	CU NIPDAU	Level-1-260C-UNLIM	<a href="#">Request Free Samples</a>
TLC2272MDR	ACTIVE	SOIC	D	8	2500	TBD	CU NIPDAU	Level-1-220C-UNLIM	<a href="#">Purchase Samples</a>
TLC2272MDRG4	ACTIVE	SOIC	D	8	2500	Green (RoHS & no Sb/Br)	CU NIPDAU	Level-1-260C-UNLIM	<a href="#">Purchase Samples</a>
TLC2272MFKB	ACTIVE	LCCC	FK	20	1	TBD	POST-PLATE	N / A for Pkg Type	Contact TI Distributor or Sales Office
TLC2272MJG	ACTIVE	CDIP	JG	8	1	TBD	A42	N / A for Pkg Type	Contact TI Distributor or Sales Office
TLC2272MJGB	ACTIVE	CDIP	JG	8	1	TBD	A42	N / A for Pkg Type	Contact TI Distributor or Sales Office
TLC2272MP	OBSOLETE	PDIP	P	8		TBD	Call TI	Call TI	Samples Not Available
TLC2272MUB	ACTIVE	CFP	U	10	1	TBD	A42	N / A for Pkg Type	Contact TI Distributor or Sales Office
TLC2272QD	ACTIVE	SOIC	D	8	75	Green (RoHS & no Sb/Br)	CU NIPDAU	Level-1-260C-UNLIM	<a href="#">Purchase Samples</a>
TLC2272QDG4	ACTIVE	SOIC	D	8	75	Green (RoHS & no Sb/Br)	CU NIPDAU	Level-1-260C-UNLIM	<a href="#">Purchase Samples</a>
TLC2272QDR	ACTIVE	SOIC	D	8	2500	Green (RoHS & no Sb/Br)	CU NIPDAU	Level-1-260C-UNLIM	<a href="#">Purchase Samples</a>

Orderable Device	Status <sup>(1)</sup>	Package Type	Package Drawing	Pins	Package Qty	Eco Plan <sup>(2)</sup>	Lead/ Ball Finish	MSL Peak Temp <sup>(3)</sup>	Samples (Requires Login)
TLC2272QDRG4	ACTIVE	SOIC	D	8	2500	Green (RoHS & no Sb/Br)	CU NIPDAU	Level-1-260C-UNLIM	<a href="#">Purchase Samples</a>
TLC2272QPWRG4	ACTIVE	TSSOP	PW	8	2000	Green (RoHS & no Sb/Br)	CU NIPDAU	Level-1-260C-UNLIM	<a href="#">Request Free Samples</a>
TLC2274ACD	ACTIVE	SOIC	D	14	50	Green (RoHS & no Sb/Br)	CU NIPDAU	Level-1-260C-UNLIM	<a href="#">Purchase Samples</a>
TLC2274ACDG4	ACTIVE	SOIC	D	14	50	Green (RoHS & no Sb/Br)	CU NIPDAU	Level-1-260C-UNLIM	<a href="#">Purchase Samples</a>
TLC2274ACDR	ACTIVE	SOIC	D	14	2500	Green (RoHS & no Sb/Br)	CU NIPDAU	Level-1-260C-UNLIM	<a href="#">Request Free Samples</a>
TLC2274ACDRG4	ACTIVE	SOIC	D	14	2500	Green (RoHS & no Sb/Br)	CU NIPDAU	Level-1-260C-UNLIM	<a href="#">Request Free Samples</a>
TLC2274ACN	ACTIVE	PDIP	N	14	25	Pb-Free (RoHS)	CU NIPDAU	N / A for Pkg Type	<a href="#">Request Free Samples</a>
TLC2274ACNE4	ACTIVE	PDIP	N	14	25	Pb-Free (RoHS)	CU NIPDAU	N / A for Pkg Type	<a href="#">Request Free Samples</a>
TLC2274ACPW	ACTIVE	TSSOP	PW	14	90	Green (RoHS & no Sb/Br)	CU NIPDAU	Level-1-260C-UNLIM	Contact TI Distributor or Sales Office
TLC2274ACPWG4	ACTIVE	TSSOP	PW	14	90	Green (RoHS & no Sb/Br)	CU NIPDAU	Level-1-260C-UNLIM	Contact TI Distributor or Sales Office
TLC2274ACPWR	ACTIVE	TSSOP	PW	14	2000	Green (RoHS & no Sb/Br)	CU NIPDAU	Level-1-260C-UNLIM	<a href="#">Request Free Samples</a>
TLC2274ACPWRG4	ACTIVE	TSSOP	PW	14	2000	Green (RoHS & no Sb/Br)	CU NIPDAU	Level-1-260C-UNLIM	<a href="#">Request Free Samples</a>
TLC2274AID	ACTIVE	SOIC	D	14	50	Green (RoHS & no Sb/Br)	CU NIPDAU	Level-1-260C-UNLIM	<a href="#">Request Free Samples</a>
TLC2274AIDG4	ACTIVE	SOIC	D	14	50	Green (RoHS & no Sb/Br)	CU NIPDAU	Level-1-260C-UNLIM	<a href="#">Request Free Samples</a>
TLC2274AIDR	ACTIVE	SOIC	D	14	2500	Green (RoHS & no Sb/Br)	CU NIPDAU	Level-1-260C-UNLIM	<a href="#">Purchase Samples</a>
TLC2274AIDRG4	ACTIVE	SOIC	D	14	2500	Green (RoHS & no Sb/Br)	CU NIPDAU	Level-1-260C-UNLIM	<a href="#">Purchase Samples</a>
TLC2274AIN	ACTIVE	PDIP	N	14	25	Pb-Free (RoHS)	CU NIPDAU	N / A for Pkg Type	<a href="#">Request Free Samples</a>
TLC2274AINE4	ACTIVE	PDIP	N	14	25	Pb-Free (RoHS)	CU NIPDAU	N / A for Pkg Type	<a href="#">Request Free Samples</a>
TLC2274AIPW	ACTIVE	TSSOP	PW	14	90	Green (RoHS & no Sb/Br)	CU NIPDAU	Level-1-260C-UNLIM	Contact TI Distributor or Sales Office

Orderable Device	Status <sup>(1)</sup>	Package Type	Package Drawing	Pins	Package Qty	Eco Plan <sup>(2)</sup>	Lead/ Ball Finish	MSL Peak Temp <sup>(3)</sup>	Samples (Requires Login)
TLC2274AIPWG4	ACTIVE	TSSOP	PW	14	90	Green (RoHS & no Sb/Br)	CU NIPDAU	Level-1-260C-UNLIM	Contact TI Distributor or Sales Office
TLC2274AIPWLE	OBSOLETE	TSSOP	PW	14		TBD	Call TI	Call TI	Replaced by TLC2274AIPWR
TLC2274AIPWR	ACTIVE	TSSOP	PW	14	2000	Green (RoHS & no Sb/Br)	CU NIPDAU	Level-1-260C-UNLIM	<a href="#">Request Free Samples</a>
TLC2274AIPWRG4	ACTIVE	TSSOP	PW	14	2000	Green (RoHS & no Sb/Br)	CU NIPDAU	Level-1-260C-UNLIM	<a href="#">Request Free Samples</a>
TLC2274AMD	ACTIVE	SOIC	D	14	50	TBD	CU NIPDAU	Level-1-220C-UNLIM	<a href="#">Request Free Samples</a>
TLC2274AMDG4	ACTIVE	SOIC	D	14	50	Green (RoHS & no Sb/Br)	CU NIPDAU	Level-1-260C-UNLIM	<a href="#">Purchase Samples</a>
TLC2274AMDR	ACTIVE	SOIC	D	14	2500	TBD	CU NIPDAU	Level-1-220C-UNLIM	<a href="#">Purchase Samples</a>
TLC2274AMDRG4	ACTIVE	SOIC	D	14	2500	Green (RoHS & no Sb/Br)	CU NIPDAU	Level-1-260C-UNLIM	<a href="#">Purchase Samples</a>
TLC2274AMFKB	ACTIVE	LCCC	FK	20	1	TBD	POST-PLATE	N / A for Pkg Type	<a href="#">Purchase Samples</a>
TLC2274AMJB	ACTIVE	CDIP	J	14	1	TBD	A42	N / A for Pkg Type	Contact TI Distributor or Sales Office
TLC2274AMWB	ACTIVE	CFP	W	14	1	TBD	A42	N / A for Pkg Type	Contact TI Distributor or Sales Office
TLC2274AQD	ACTIVE	SOIC	D	14	50	TBD	CU NIPDAU	Level-1-220C-UNLIM	<a href="#">Request Free Samples</a>
TLC2274AQDG4	ACTIVE	SOIC	D	14	50	Green (RoHS & no Sb/Br)	CU NIPDAU	Level-1-260C-UNLIM	<a href="#">Purchase Samples</a>
TLC2274AQDR	ACTIVE	SOIC	D	14	2500	TBD	CU NIPDAU	Level-1-220C-UNLIM	<a href="#">Purchase Samples</a>
TLC2274AQDRG4	ACTIVE	SOIC	D	14	2500	Green (RoHS & no Sb/Br)	CU NIPDAU	Level-1-260C-UNLIM	<a href="#">Purchase Samples</a>
TLC2274CD	ACTIVE	SOIC	D	14	50	Green (RoHS & no Sb/Br)	CU NIPDAU	Level-1-260C-UNLIM	<a href="#">Request Free Samples</a>
TLC2274CDG4	ACTIVE	SOIC	D	14	50	Green (RoHS & no Sb/Br)	CU NIPDAU	Level-1-260C-UNLIM	<a href="#">Request Free Samples</a>
TLC2274CDR	ACTIVE	SOIC	D	14	2500	Green (RoHS & no Sb/Br)	CU NIPDAU	Level-1-260C-UNLIM	<a href="#">Purchase Samples</a>
TLC2274CDRG4	ACTIVE	SOIC	D	14	2500	Green (RoHS & no Sb/Br)	CU NIPDAU	Level-1-260C-UNLIM	<a href="#">Purchase Samples</a>
TLC2274CN	ACTIVE	PDIP	N	14	25	Pb-Free (RoHS)	CU NIPDAU	N / A for Pkg Type	<a href="#">Request Free Samples</a>
TLC2274CNE4	ACTIVE	PDIP	N	14	25	Pb-Free (RoHS)	CU NIPDAU	N / A for Pkg Type	<a href="#">Request Free Samples</a>

Orderable Device	Status <sup>(1)</sup>	Package Type	Package Drawing	Pins	Package Qty	Eco Plan <sup>(2)</sup>	Lead/ Ball Finish	MSL Peak Temp <sup>(3)</sup>	Samples (Requires Login)
TLC2274CNSR	ACTIVE	SO	NS	14	2000	Green (RoHS & no Sb/Br)	CU NIPDAU	Level-1-260C-UNLIM	<a href="#">Purchase Samples</a>
TLC2274CNSRG4	ACTIVE	SO	NS	14	2000	Green (RoHS & no Sb/Br)	CU NIPDAU	Level-1-260C-UNLIM	<a href="#">Purchase Samples</a>
TLC2274CPW	ACTIVE	TSSOP	PW	14	90	Green (RoHS & no Sb/Br)	CU NIPDAU	Level-1-260C-UNLIM	Contact TI Distributor or Sales Office
TLC2274CPWG4	ACTIVE	TSSOP	PW	14	90	Green (RoHS & no Sb/Br)	CU NIPDAU	Level-1-260C-UNLIM	Contact TI Distributor or Sales Office
TLC2274CPWLE	OBSOLETE	TSSOP	PW	14		TBD	Call TI	Call TI	Samples Not Available
TLC2274CPWR	ACTIVE	TSSOP	PW	14	2000	Green (RoHS & no Sb/Br)	CU NIPDAU	Level-1-260C-UNLIM	<a href="#">Request Free Samples</a>
TLC2274CPWRG4	ACTIVE	TSSOP	PW	14	2000	Green (RoHS & no Sb/Br)	CU NIPDAU	Level-1-260C-UNLIM	<a href="#">Request Free Samples</a>
TLC2274ID	ACTIVE	SOIC	D	14	50	Green (RoHS & no Sb/Br)	CU NIPDAU	Level-1-260C-UNLIM	<a href="#">Request Free Samples</a>
TLC2274IDG4	ACTIVE	SOIC	D	14	50	Green (RoHS & no Sb/Br)	CU NIPDAU	Level-1-260C-UNLIM	<a href="#">Request Free Samples</a>
TLC2274IDR	ACTIVE	SOIC	D	14	2500	Green (RoHS & no Sb/Br)	CU NIPDAU	Level-1-260C-UNLIM	<a href="#">Purchase Samples</a>
TLC2274IDRG4	ACTIVE	SOIC	D	14	2500	Green (RoHS & no Sb/Br)	CU NIPDAU	Level-1-260C-UNLIM	<a href="#">Purchase Samples</a>
TLC2274IN	ACTIVE	PDIP	N	14	25	Pb-Free (RoHS)	CU NIPDAU	N / A for Pkg Type	<a href="#">Request Free Samples</a>
TLC2274INE4	ACTIVE	PDIP	N	14	25	Pb-Free (RoHS)	CU NIPDAU	N / A for Pkg Type	<a href="#">Request Free Samples</a>
TLC2274IPW	ACTIVE	TSSOP	PW	14	90	Green (RoHS & no Sb/Br)	CU NIPDAU	Level-1-260C-UNLIM	Contact TI Distributor or Sales Office
TLC2274IPWG4	ACTIVE	TSSOP	PW	14	90	Green (RoHS & no Sb/Br)	CU NIPDAU	Level-1-260C-UNLIM	Contact TI Distributor or Sales Office
TLC2274IPWLE	OBSOLETE	TSSOP	PW	14		TBD	Call TI	Call TI	Samples Not Available
TLC2274IPWR	ACTIVE	TSSOP	PW	14	2000	Green (RoHS & no Sb/Br)	CU NIPDAU	Level-1-260C-UNLIM	<a href="#">Request Free Samples</a>
TLC2274IPWRG4	ACTIVE	TSSOP	PW	14	2000	Green (RoHS & no Sb/Br)	CU NIPDAU	Level-1-260C-UNLIM	<a href="#">Request Free Samples</a>
TLC2274MD	ACTIVE	SOIC	D	14	50	TBD	CU NIPDAU	Level-1-220C-UNLIM	<a href="#">Purchase Samples</a>
TLC2274MDG4	ACTIVE	SOIC	D	14	50	Green (RoHS & no Sb/Br)	CU NIPDAU	Level-1-260C-UNLIM	<a href="#">Purchase Samples</a>

Orderable Device	Status <sup>(1)</sup>	Package Type	Package Drawing	Pins	Package Qty	Eco Plan <sup>(2)</sup>	Lead/ Ball Finish	MSL Peak Temp <sup>(3)</sup>	Samples (Requires Login)
TLC2274MDR	ACTIVE	SOIC	D	14	2500	TBD	CU NIPDAU	Level-1-220C-UNLIM	<a href="#">Purchase Samples</a>
TLC2274MDRG4	ACTIVE	SOIC	D	14	2500	Green (RoHS & no Sb/Br)	CU NIPDAU	Level-1-260C-UNLIM	<a href="#">Request Free Samples</a>
TLC2274MFKB	ACTIVE	LCCC	FK	20	1	TBD	POST-PLATE	N / A for Pkg Type	<a href="#">Purchase Samples</a>
TLC2274MJ	ACTIVE	CDIP	J	14	1	TBD	A42	N / A for Pkg Type	<a href="#">Purchase Samples</a>
TLC2274MJB	ACTIVE	CDIP	J	14	1	TBD	A42	N / A for Pkg Type	<a href="#">Purchase Samples</a>
TLC2274MN	ACTIVE	PDIP	N	14	25	Pb-Free (RoHS)	CU NIPDAU	N / A for Pkg Type	<a href="#">Purchase Samples</a>
TLC2274MWB	ACTIVE	CFP	W	14	1	TBD	A42	N / A for Pkg Type	<a href="#">Purchase Samples</a>
TLC2274QD	ACTIVE	SOIC	D	14	50	TBD	CU NIPDAU	Level-1-220C-UNLIM	<a href="#">Request Free Samples</a>
TLC2274QDG4	ACTIVE	SOIC	D	14	50	Green (RoHS & no Sb/Br)	CU NIPDAU	Level-1-260C-UNLIM	<a href="#">Purchase Samples</a>
TLC2274QDR	ACTIVE	SOIC	D	14	2500	TBD	CU NIPDAU	Level-1-220C-UNLIM	<a href="#">Purchase Samples</a>
TLC2274QDRG4	ACTIVE	SOIC	D	14	2500	Green (RoHS & no Sb/Br)	CU NIPDAU	Level-1-260C-UNLIM	<a href="#">Purchase Samples</a>
TLC2274Y	PREVIEW	DIESALE	Y	0		TBD	Call TI	Call TI	Samples Not Available

<sup>(1)</sup> The marketing status values are defined as follows:

**ACTIVE:** Product device recommended for new designs.

**LIFEBUY:** TI has announced that the device will be discontinued, and a lifetime-buy period is in effect.

**NRND:** Not recommended for new designs. Device is in production to support existing customers, but TI does not recommend using this part in a new design.

**PREVIEW:** Device has been announced but is not in production. Samples may or may not be available.

**OBSELETE:** TI has discontinued the production of the device.

<sup>(2)</sup> Eco Plan - The planned eco-friendly classification: Pb-Free (RoHS), Pb-Free (RoHS Exempt), or Green (RoHS & no Sb/Br) - please check <http://www.ti.com/productcontent> for the latest availability information and additional product content details.

**TBD:** The Pb-Free/Green conversion plan has not been defined.

**Pb-Free (RoHS):** TI's terms "Lead-Free" or "Pb-Free" mean semiconductor products that are compatible with the current RoHS requirements for all 6 substances, including the requirement that lead not exceed 0.1% by weight in homogeneous materials. Where designed to be soldered at high temperatures, TI Pb-Free products are suitable for use in specified lead-free processes.

**Pb-Free (RoHS Exempt):** This component has a RoHS exemption for either 1) lead-based flip-chip solder bumps used between the die and package, or 2) lead-based die adhesive used between the die and leadframe. The component is otherwise considered Pb-Free (RoHS compatible) as defined above.

**Green (RoHS & no Sb/Br):** TI defines "Green" to mean Pb-Free (RoHS compatible), and free of Bromine (Br) and Antimony (Sb) based flame retardants (Br or Sb do not exceed 0.1% by weight in homogeneous material)

<sup>(3)</sup> MSL, Peak Temp. -- The Moisture Sensitivity Level rating according to the JEDEC industry standard classifications, and peak solder temperature.

**Important Information and Disclaimer:** The information provided on this page represents TI's knowledge and belief as of the date that it is provided. TI bases its knowledge and belief on information provided by third parties, and makes no representation or warranty as to the accuracy of such information. Efforts are underway to better integrate information from third parties. TI has taken and

---

continues to take reasonable steps to provide representative and accurate information but may not have conducted destructive testing or chemical analysis on incoming materials and chemicals. TI and TI suppliers consider certain information to be proprietary, and thus CAS numbers and other limited information may not be available for release.

In no event shall TI's liability arising out of such information exceed the total purchase price of the TI part(s) at issue in this document sold by TI to Customer on an annual basis.

**OTHER QUALIFIED VERSIONS OF TLC2272, TLC2272A, TLC2272AM, TLC2272M, TLC2274, TLC2274A, TLC2274AM, TLC2274M :**

- Catalog: [TLC2272A](#), [TLC2272](#), [TLC2274A](#), [TLC2274](#)
- Automotive: [TLC2272-Q1](#), [TLC2272A-Q1](#), [TLC2272A-Q1](#), [TLC2272-Q1](#), [TLC2274-Q1](#), [TLC2274A-Q1](#), [TLC2274A-Q1](#), [TLC2274-Q1](#)
- Enhanced Product: [TLC2272A-EP](#), [TLC2272A-EP](#), [TLC2274-EP](#), [TLC2274A-EP](#), [TLC2274A-EP](#), [TLC2274-EP](#)
- Military: [TLC2272M](#), [TLC2272AM](#), [TLC2274M](#), [TLC2274AM](#)

NOTE: Qualified Version Definitions:

- Catalog - TI's standard catalog product
- Automotive - Q100 devices qualified for high-reliability automotive applications targeting zero defects
- Enhanced Product - Supports Defense, Aerospace and Medical Applications
- Military - QML certified for Military and Defense Applications

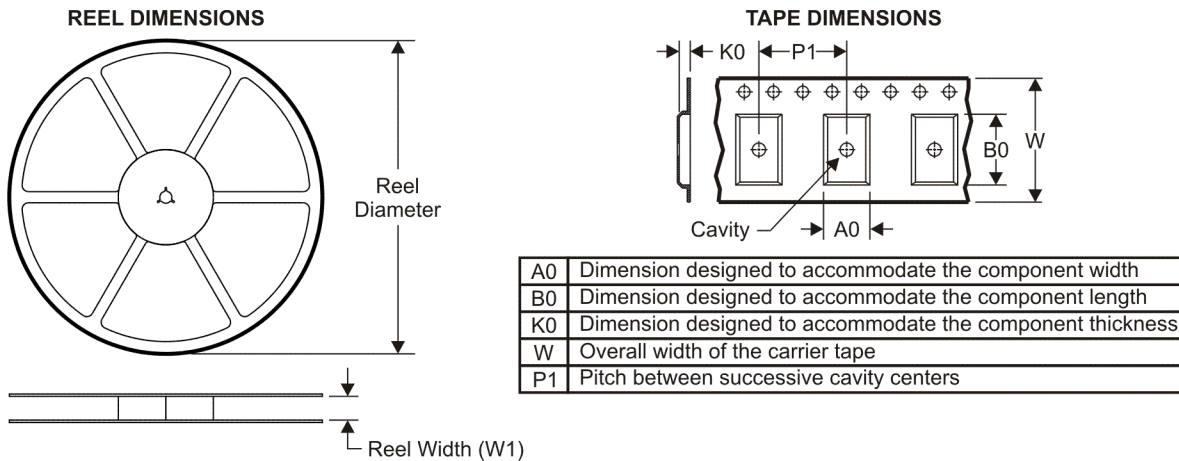
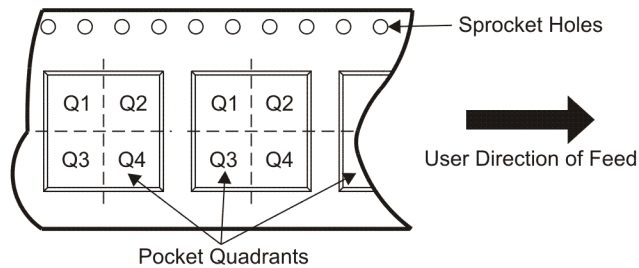
**TAPE AND REEL INFORMATION**

**QUADRANT ASSIGNMENTS FOR PIN 1 ORIENTATION IN TAPE**

\*All dimensions are nominal

Device	Package Type	Package Drawing	Pins	SPQ	Reel Diameter (mm)	Reel Width W1 (mm)	A0 (mm)	B0 (mm)	K0 (mm)	P1 (mm)	W (mm)	Pin1 Quadrant
5962-9555201NXDR	SOIC	D	8	2500	330.0	12.4	6.4	5.2	2.1	8.0	12.0	Q1
TLC2272ACDR	SOIC	D	8	2500	330.0	12.4	6.4	5.2	2.1	8.0	12.0	Q1
TLC2272ACPWR	TSSOP	PW	8	2000	330.0	12.4	7.0	3.6	1.6	8.0	12.0	Q1
TLC2272AIDR	SOIC	D	8	2500	330.0	12.4	6.4	5.2	2.1	8.0	12.0	Q1
TLC2272AMDR	SOIC	D	8	2500	330.0	12.4	6.4	5.2	2.1	8.0	12.0	Q1
TLC2272CDR	SOIC	D	8	2500	330.0	12.4	6.4	5.2	2.1	8.0	12.0	Q1
TLC2272CPSR	SO	PS	8	2000	330.0	16.4	8.2	6.6	2.5	12.0	16.0	Q1
TLC2272CPWR	TSSOP	PW	8	2000	330.0	12.4	7.0	3.6	1.6	8.0	12.0	Q1
TLC2272IDR	SOIC	D	8	2500	330.0	12.4	6.4	5.2	2.1	8.0	12.0	Q1
TLC2272IPWR	TSSOP	PW	8	2000	330.0	12.4	7.0	3.6	1.6	8.0	12.0	Q1
TLC2272MDR	SOIC	D	8	2500	330.0	12.4	6.4	5.2	2.1	8.0	12.0	Q1
TLC2274ACDR	SOIC	D	14	2500	330.0	16.4	6.5	9.0	2.1	8.0	16.0	Q1
TLC2274ACPWR	TSSOP	PW	14	2000	330.0	12.4	6.9	5.6	1.6	8.0	12.0	Q1
TLC2274AIDR	SOIC	D	14	2500	330.0	16.4	6.5	9.0	2.1	8.0	16.0	Q1
TLC2274AIPWR	TSSOP	PW	14	2000	330.0	12.4	6.9	5.6	1.6	8.0	12.0	Q1
TLC2274AMDR	SOIC	D	14	2500	330.0	16.4	6.5	9.0	2.1	8.0	16.0	Q1
TLC2274AQDR	SOIC	D	14	2500	330.0	16.4	6.5	9.0	2.1	8.0	16.0	Q1
TLC2274CDR	SOIC	D	14	2500	330.0	16.4	6.5	9.0	2.1	8.0	16.0	Q1

Device	Package Type	Package Drawing	Pins	SPQ	Reel Diameter (mm)	Reel Width W1 (mm)	A0 (mm)	B0 (mm)	K0 (mm)	P1 (mm)	W (mm)	Pin1 Quadrant
TLC2274CNSR	SO	NS	14	2000	330.0	16.4	8.2	10.5	2.5	12.0	16.0	Q1
TLC2274CPWR	TSSOP	PW	14	2000	330.0	12.4	6.9	5.6	1.6	8.0	12.0	Q1
TLC2274IDR	SOIC	D	14	2500	330.0	16.4	6.5	9.0	2.1	8.0	16.0	Q1
TLC2274IPWR	TSSOP	PW	14	2000	330.0	12.4	6.9	5.6	1.6	8.0	12.0	Q1
TLC2274MDR	SOIC	D	14	2500	330.0	16.4	6.5	9.0	2.1	8.0	16.0	Q1
TLC2274QDR	SOIC	D	14	2500	330.0	16.4	6.5	9.0	2.1	8.0	16.0	Q1

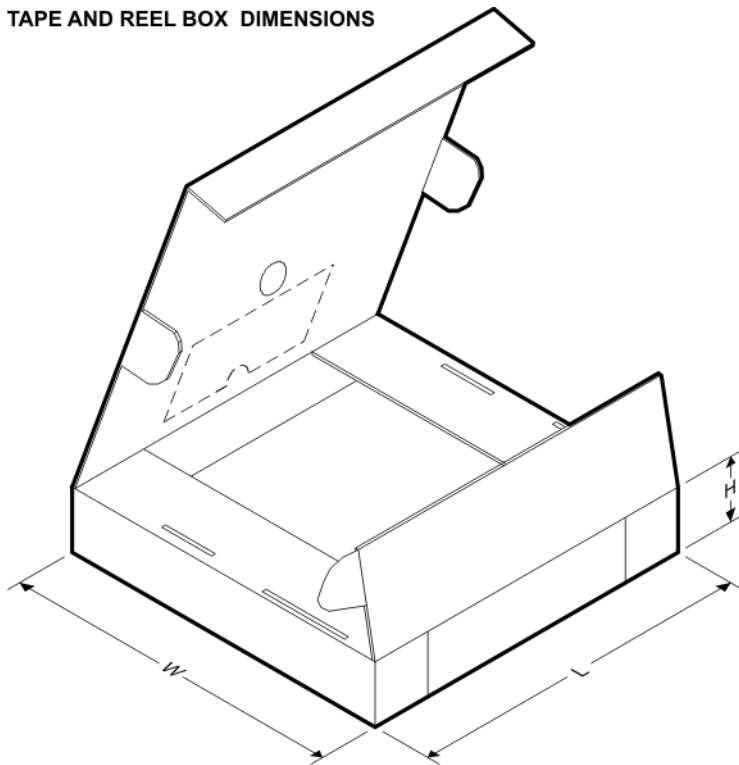
## TAPE AND REEL BOX DIMENSIONS



\*All dimensions are nominal

Device	Package Type	Package Drawing	Pins	SPQ	Length (mm)	Width (mm)	Height (mm)
5962-9555201NXDR	SOIC	D	8	2500	346.0	346.0	29.0
TLC2272ACDR	SOIC	D	8	2500	340.5	338.1	20.6
TLC2272ACPWR	TSSOP	PW	8	2000	346.0	346.0	29.0
TLC2272AIDR	SOIC	D	8	2500	340.5	338.1	20.6
TLC2272AMDR	SOIC	D	8	2500	346.0	346.0	29.0
TLC2272CDR	SOIC	D	8	2500	340.5	338.1	20.6
TLC2272CPSR	SO	PS	8	2000	346.0	346.0	33.0
TLC2272CPWR	TSSOP	PW	8	2000	346.0	346.0	29.0
TLC2272IDR	SOIC	D	8	2500	340.5	338.1	20.6
TLC2272IPWR	TSSOP	PW	8	2000	346.0	346.0	29.0
TLC2272MDR	SOIC	D	8	2500	346.0	346.0	29.0

Device	Package Type	Package Drawing	Pins	SPQ	Length (mm)	Width (mm)	Height (mm)
TLC2274ACDR	SOIC	D	14	2500	333.2	345.9	28.6
TLC2274ACPWR	TSSOP	PW	14	2000	346.0	346.0	29.0
TLC2274AIDR	SOIC	D	14	2500	333.2	345.9	28.6
TLC2274AIPWR	TSSOP	PW	14	2000	346.0	346.0	29.0
TLC2274AMDR	SOIC	D	14	2500	346.0	346.0	33.0
TLC2274AQDR	SOIC	D	14	2500	346.0	346.0	33.0
TLC2274CDR	SOIC	D	14	2500	333.2	345.9	28.6
TLC2274CNSR	SO	NS	14	2000	346.0	346.0	33.0
TLC2274CPWR	TSSOP	PW	14	2000	346.0	346.0	29.0
TLC2274IDR	SOIC	D	14	2500	333.2	345.9	28.6
TLC2274IPWR	TSSOP	PW	14	2000	346.0	346.0	29.0
TLC2274MDR	SOIC	D	14	2500	346.0	346.0	33.0
TLC2274QDR	SOIC	D	14	2500	346.0	346.0	33.0

JG (R-GDIP-T8)

CERAMIC DUAL-IN-LINE

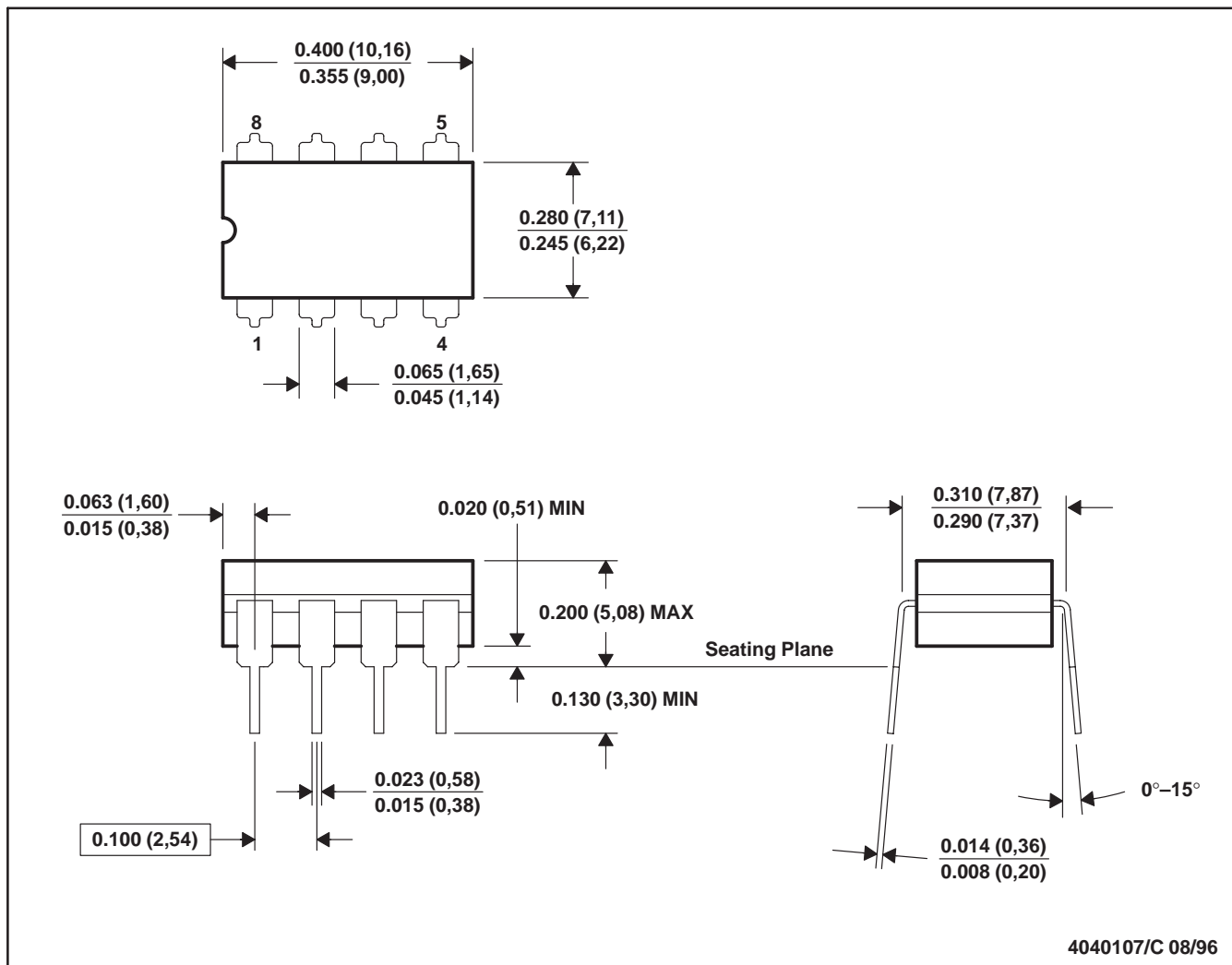

- NOTES: A. All linear dimensions are in inches (millimeters).  
 B. This drawing is subject to change without notice.  
 C. This package can be hermetically sealed with a ceramic lid using glass frit.  
 D. Index point is provided on cap for terminal identification.  
 E. Falls within MIL STD 1835 GDIP1-T8

# J (R-GDIP-T\*\*)

14 LEADS SHOWN

# CERAMIC DUAL IN-LINE PACKAGE

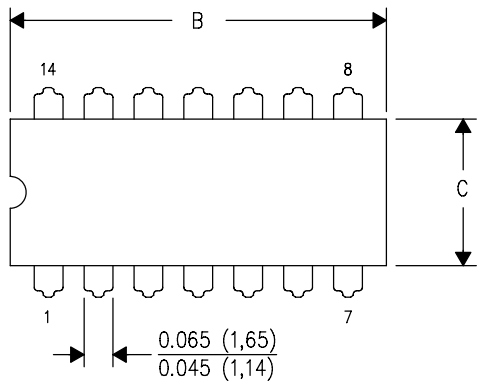

DIM \ PINS **	14	16	18	20
A	0.300 (7,62) BSC	0.300 (7,62) BSC	0.300 (7,62) BSC	0.300 (7,62) BSC
B MAX	0.785 (19,94)	.840 (21,34)	0.960 (24,38)	1.060 (26,92)
B MIN	—	—	—	—
C MAX	0.300 (7,62)	0.300 (7,62)	0.310 (7,87)	0.300 (7,62)
C MIN	0.245 (6,22)	0.245 (6,22)	0.220 (5,59)	0.245 (6,22)

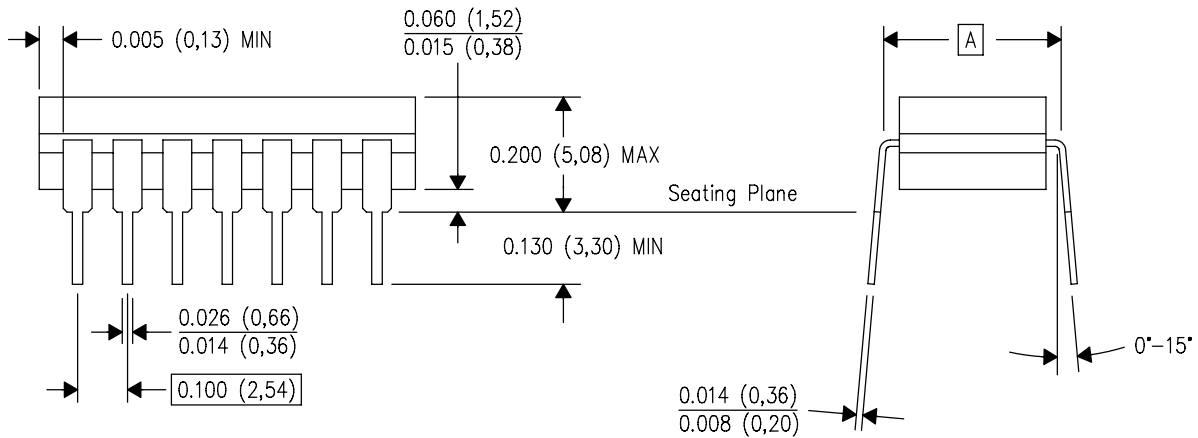

4040083/F 03/03

- NOTES:
- All linear dimensions are in inches (millimeters).
  - This drawing is subject to change without notice.
  - This package is hermetically sealed with a ceramic lid using glass frit.
  - Index point is provided on cap for terminal identification only on press ceramic glass frit seal only.
  - Falls within MIL STD 1835 GDIP1-T14, GDIP1-T16, GDIP1-T18 and GDIP1-T20.





FK (S-CQCC-N\*\*)

LEADLESS CERAMIC CHIP CARRIER

28 TERMINAL SHOWN

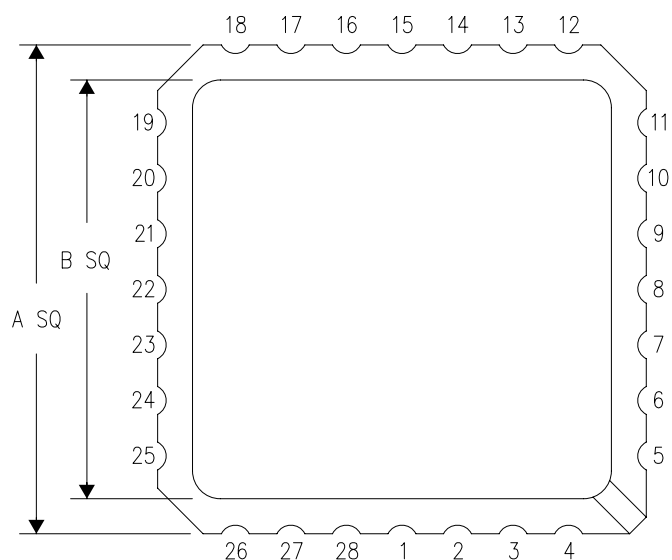

NO. OF TERMINALS **	A		B	
	MIN	MAX	MIN	MAX
20	0.342 (8,69)	0.358 (9,09)	0.307 (7,80)	0.358 (9,09)
28	0.442 (11,23)	0.458 (11,63)	0.406 (10,31)	0.458 (11,63)
44	0.640 (16,26)	0.660 (16,76)	0.495 (12,58)	0.560 (14,22)
52	0.740 (18,78)	0.761 (19,32)	0.495 (12,58)	0.560 (14,22)
68	0.938 (23,83)	0.962 (24,43)	0.850 (21,6)	0.858 (21,8)
84	1.141 (28,99)	1.165 (29,59)	1.047 (26,6)	1.063 (27,0)

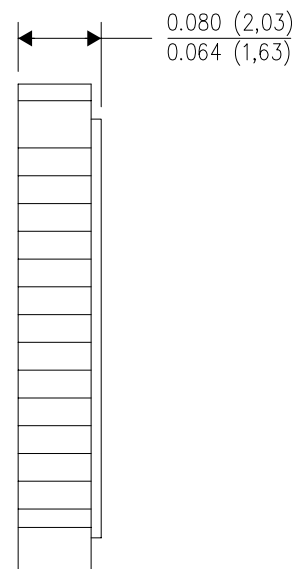
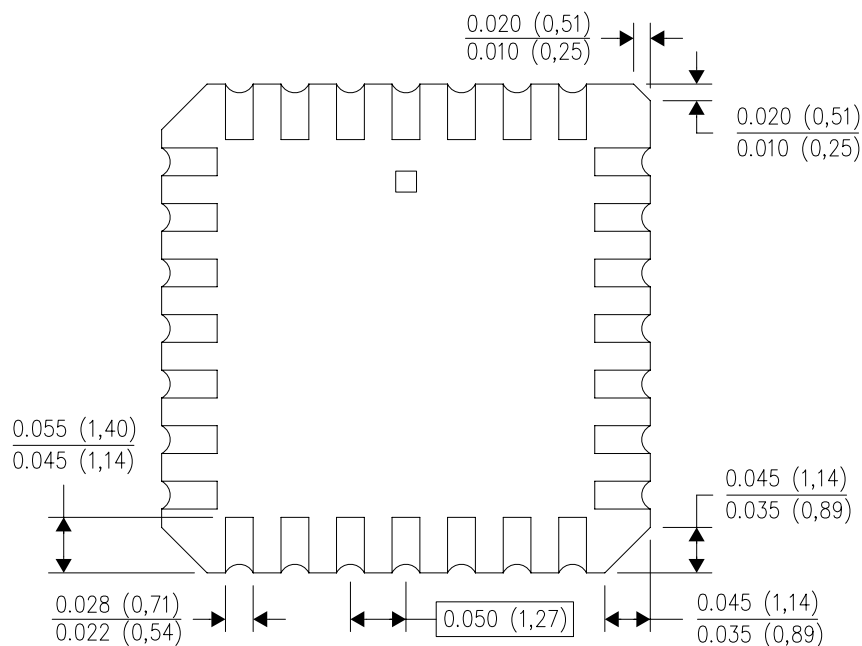

4040140/D 01/11

- NOTES:
- All linear dimensions are in inches (millimeters).
  - This drawing is subject to change without notice.
  - This package can be hermetically sealed with a metal lid.
  - Falls within JEDEC MS-004



D (R-PDSO-G14)

PLASTIC SMALL OUTLINE

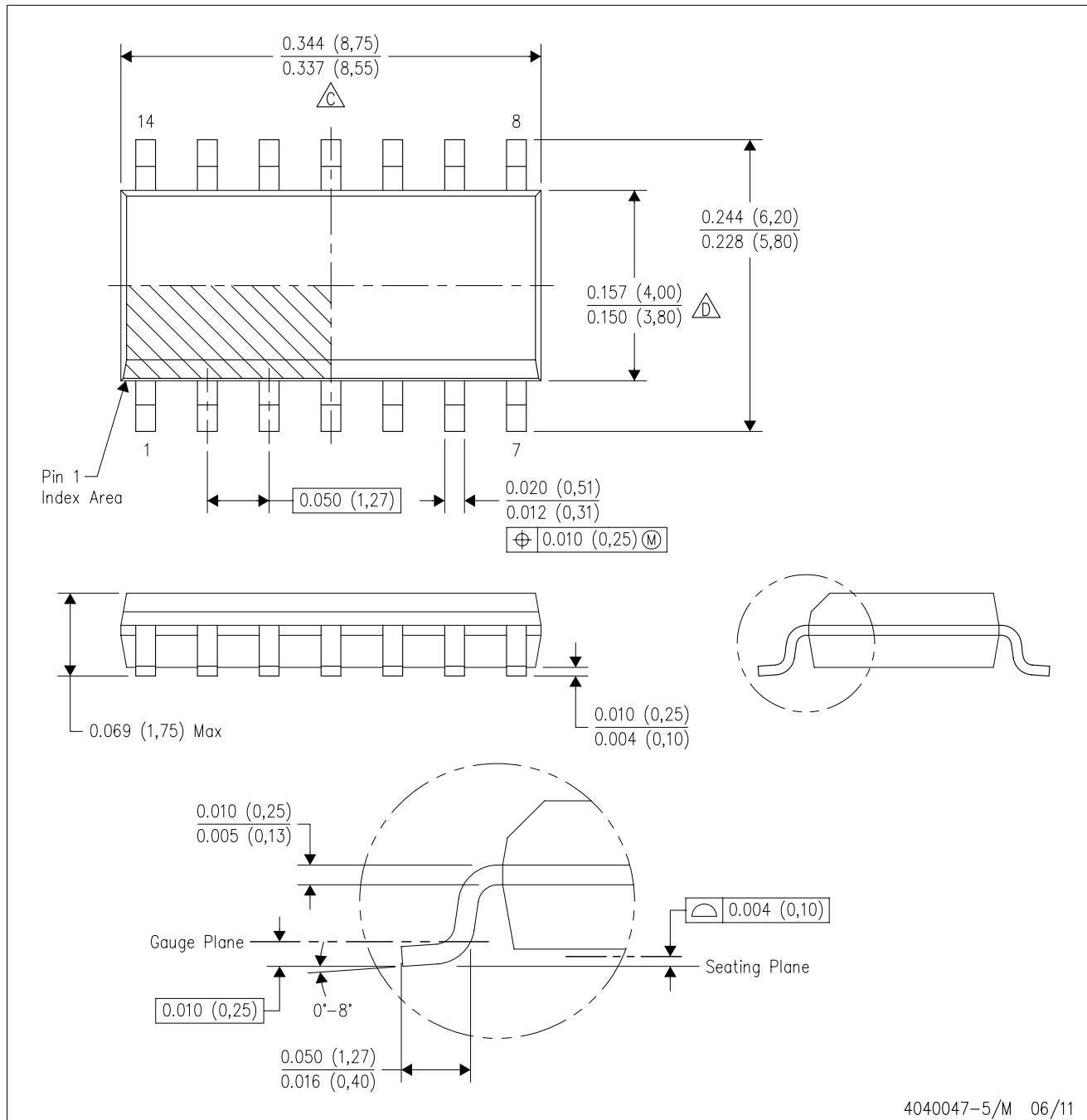

- NOTES:
- A. All linear dimensions are in inches (millimeters).
  - B. This drawing is subject to change without notice.
  - Body length does not include mold flash, protrusions, or gate burrs. Mold flash, protrusions, or gate burrs shall not exceed 0.006 (0,15) each side.
  - Body width does not include interlead flash. Interlead flash shall not exceed 0.017 (0,43) each side.
  - E. Reference JEDEC MS-012 variation AB.

PW (R-PDSO-G14)

PLASTIC SMALL OUTLINE

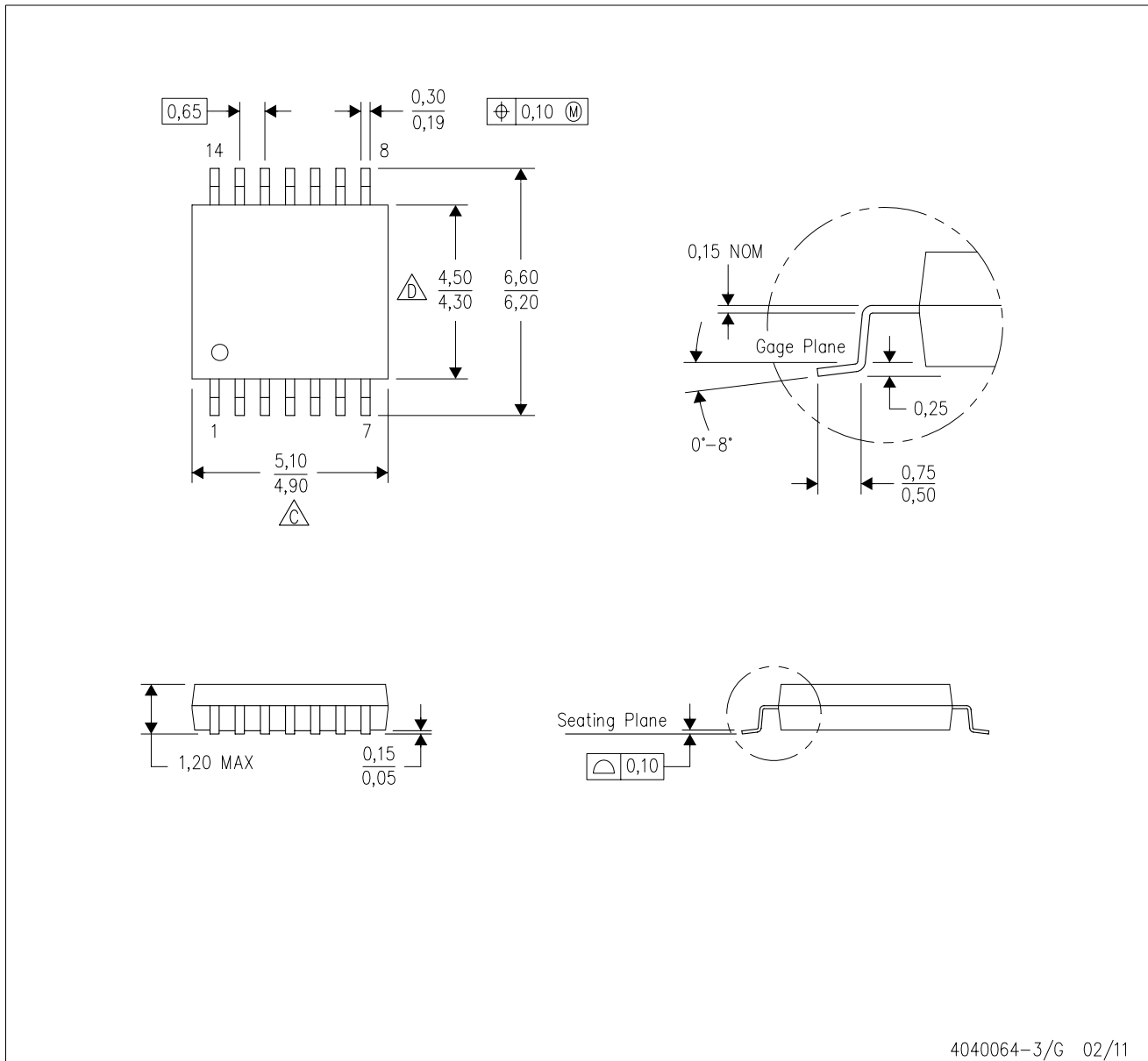

4040064-3/G 02/11

- NOTES:
- A. All linear dimensions are in millimeters. Dimensioning and tolerancing per ASME Y14.5M-1994.
  - B. This drawing is subject to change without notice.
  - C. Body length does not include mold flash, protrusions, or gate burrs. Mold flash, protrusions, or gate burrs shall not exceed 0,15 each side.
  - D. Body width does not include interlead flash. Interlead flash shall not exceed 0,25 each side.
  - E. Falls within JEDEC MO-153

PW (R-PDSO-G14)

PLASTIC SMALL OUTLINE

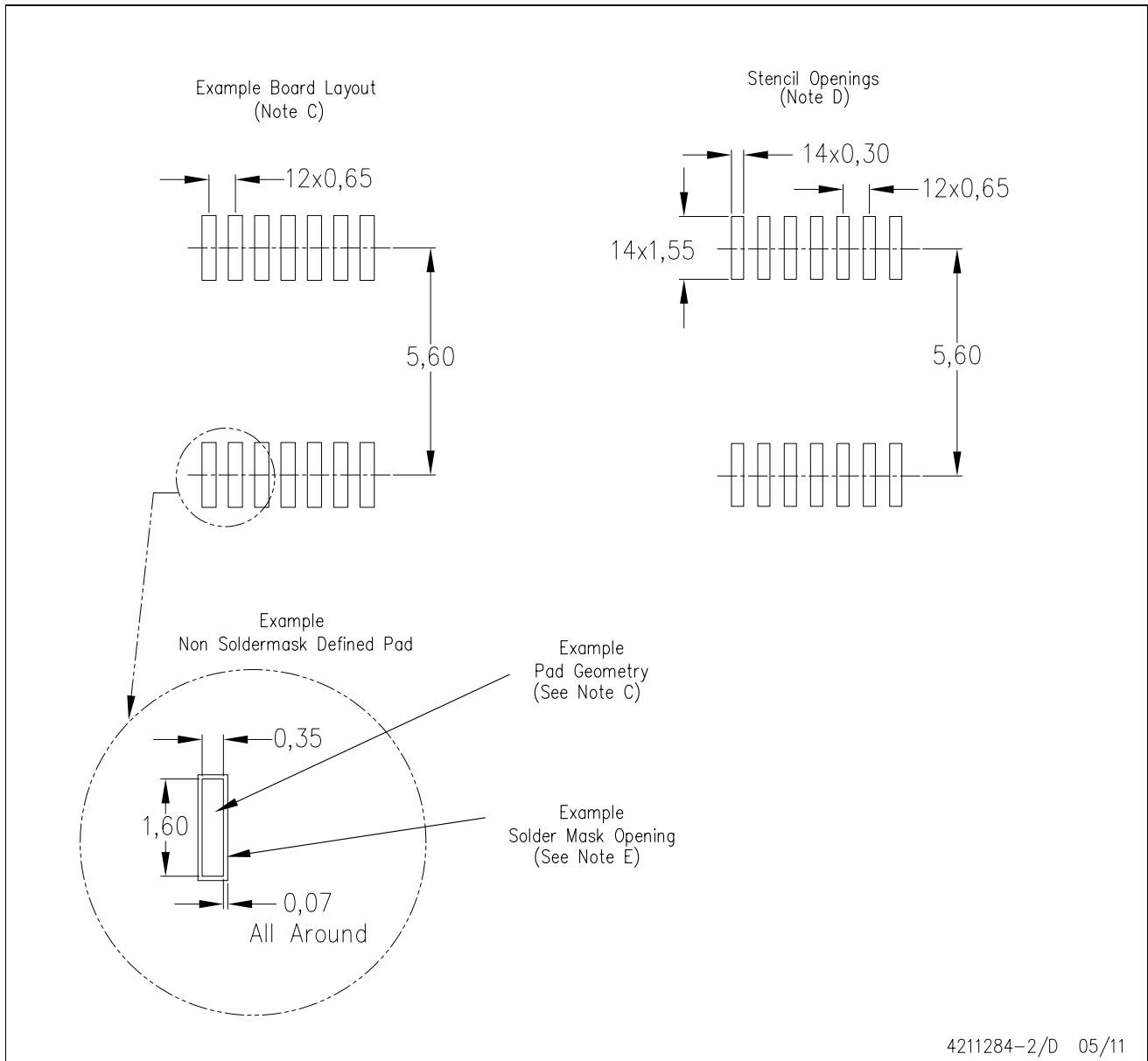

- NOTES:
- All linear dimensions are in millimeters.
  - This drawing is subject to change without notice.
  - Publication IPC-7351 is recommended for alternate designs.
  - Laser cutting apertures with trapezoidal walls and also rounding corners will offer better paste release. Customers should contact their board assembly site for stencil design recommendations. Refer to IPC-7525 for other stencil recommendations.
  - Customers should contact their board fabrication site for solder mask tolerances between and around signal pads.

PW (R-PDSO-G28)

PLASTIC SMALL OUTLINE

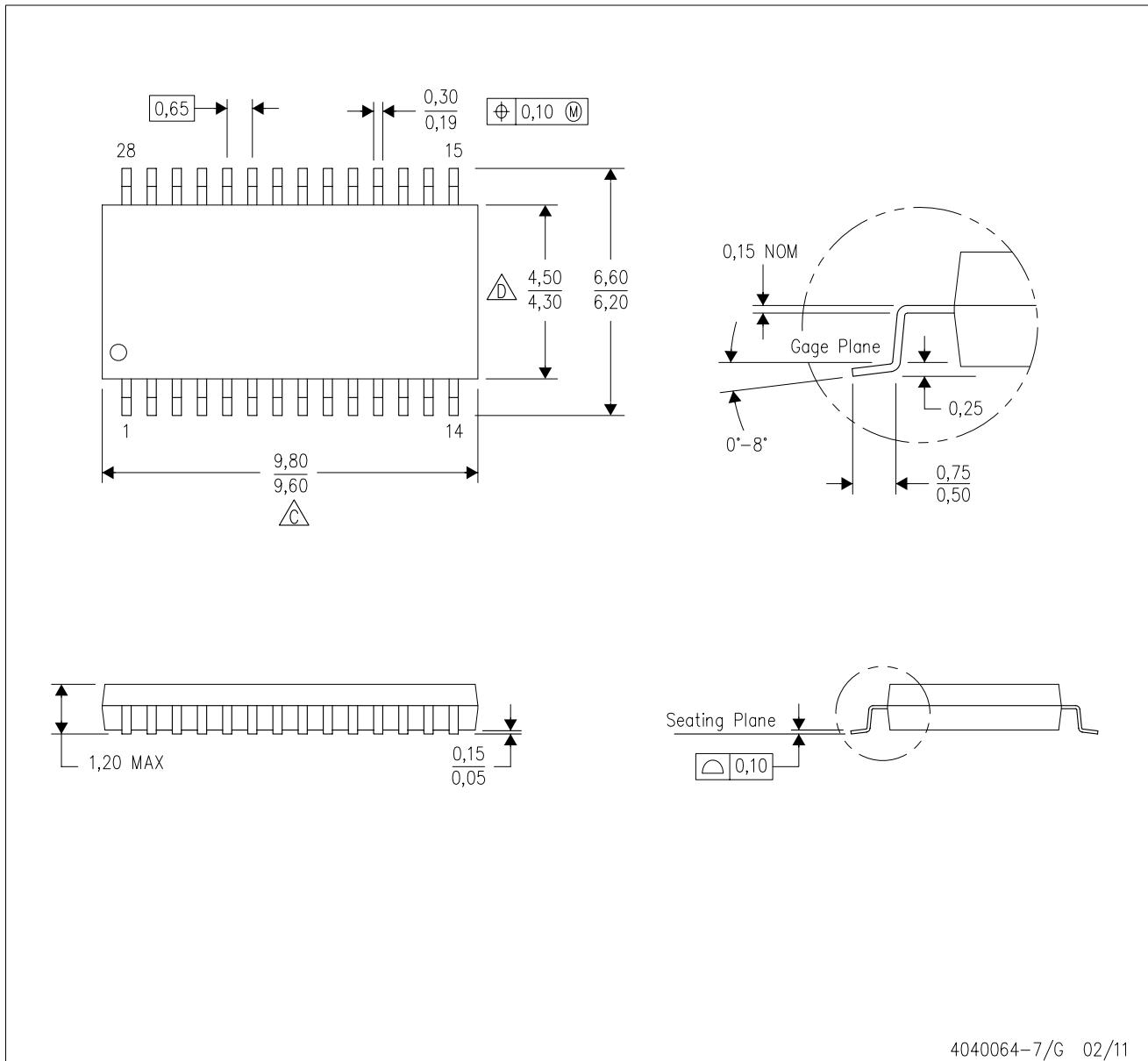

4040064-7/G 02/11

- NOTES:
- A. All linear dimensions are in millimeters. Dimensioning and tolerancing per ASME Y14.5M-1994.
  - B. This drawing is subject to change without notice.
  - C. Body length does not include mold flash, protrusions, or gate burrs. Mold flash, protrusions, or gate burrs shall not exceed 0,15 each side.
  - D. Body width does not include interlead flash. Interlead flash shall not exceed 0,25 each side.
  - E. Falls within JEDEC MO-153



D (R-PDSO-G8)

PLASTIC SMALL OUTLINE

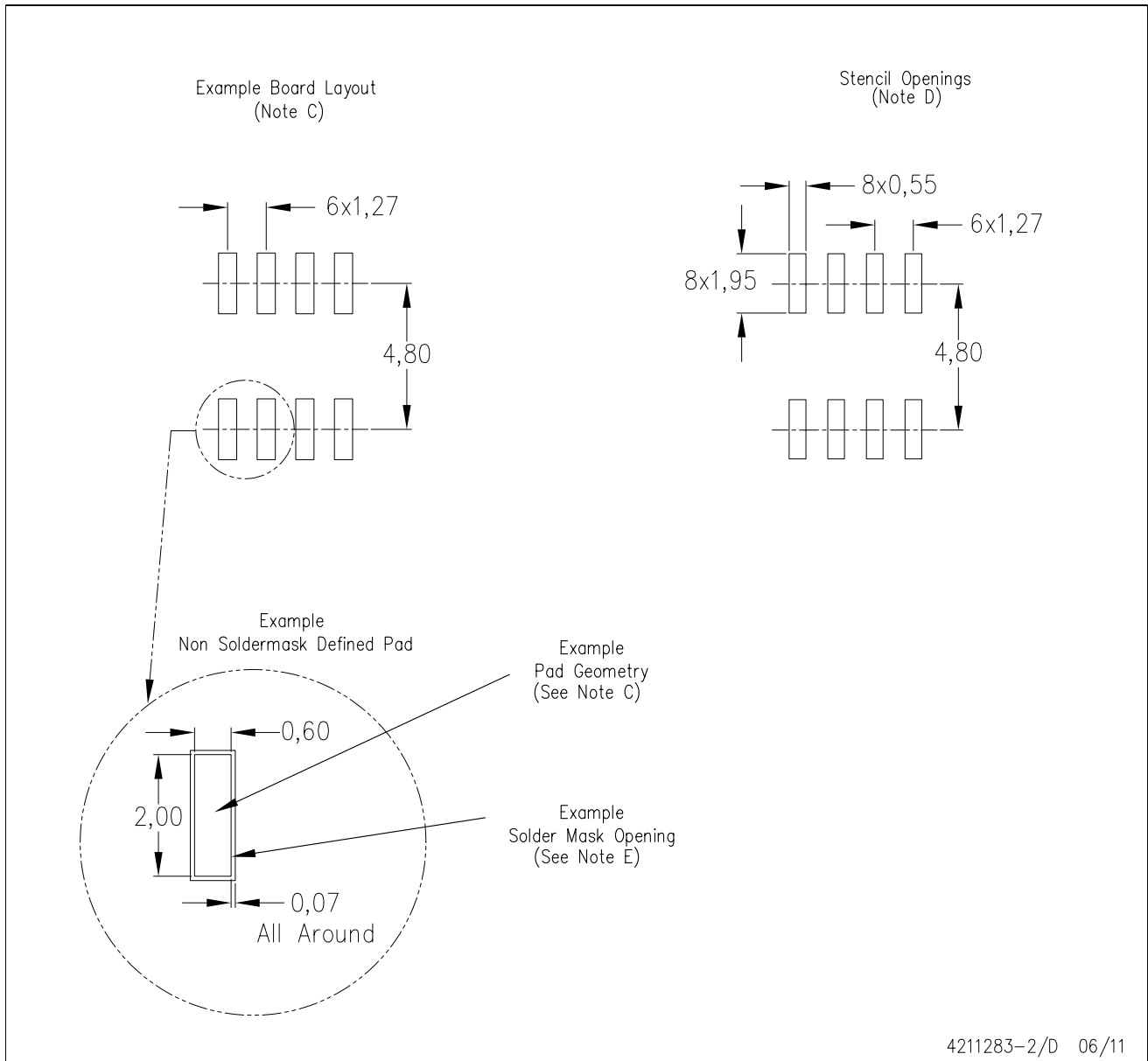

- NOTES:
- All linear dimensions are in millimeters.
  - This drawing is subject to change without notice.
  - Publication IPC-7351 is recommended for alternate designs.
  - Laser cutting apertures with trapezoidal walls and also rounding corners will offer better paste release. Customers should contact their board assembly site for stencil design recommendations. Refer to IPC-7525 for other stencil recommendations.
  - Customers should contact their board fabrication site for solder mask tolerances between and around signal pads.

# MECHANICAL DATA

PS (R-PDSO-G8)

PLASTIC SMALL-OUTLINE PACKAGE

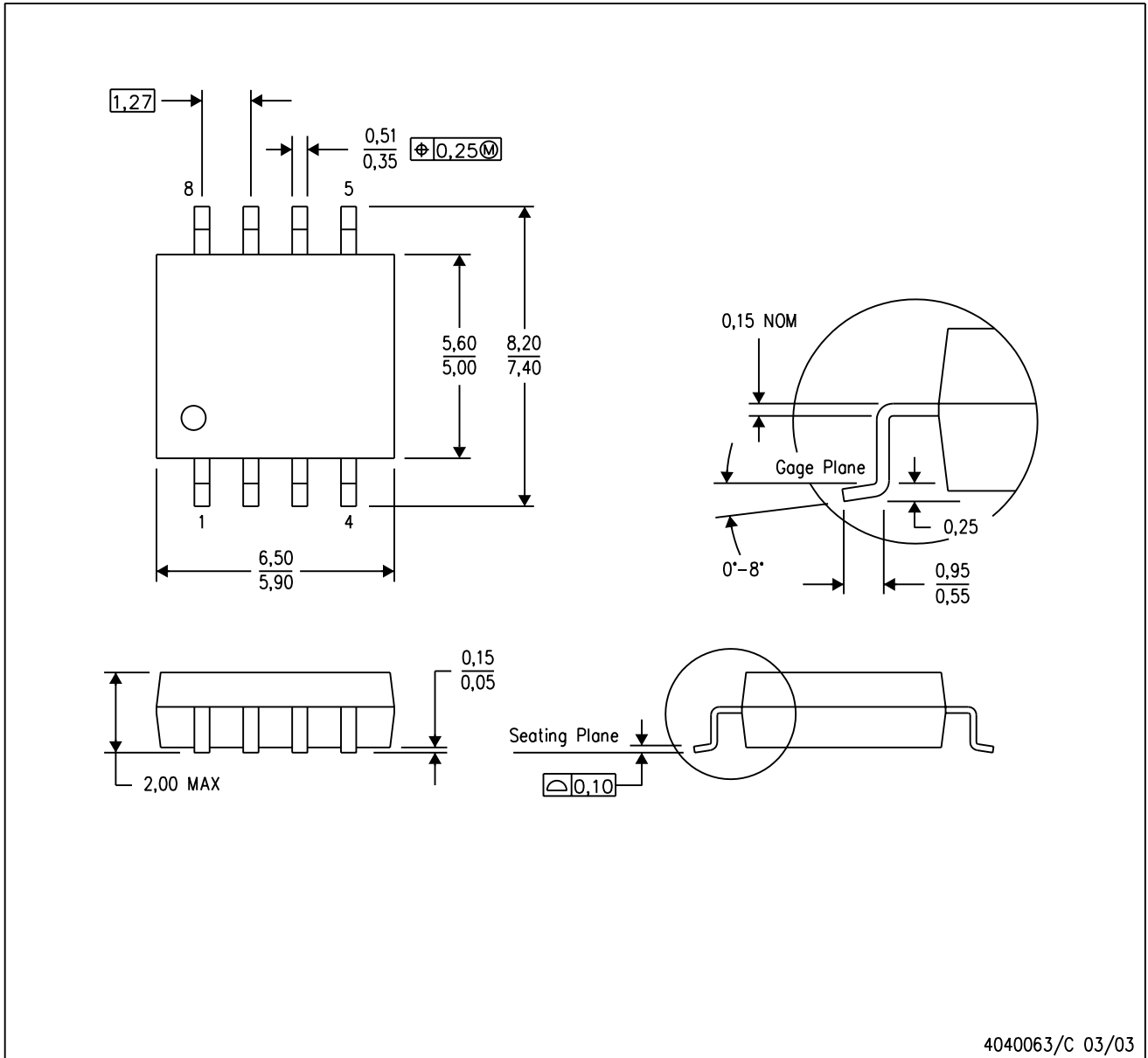

- NOTES:
- A. All linear dimensions are in millimeters.
  - B. This drawing is subject to change without notice.
  - C. Body dimensions do not include mold flash or protrusion, not to exceed 0,15.

# MECHANICAL DATA

NS (R-PDSO-G\*\*)

PLASTIC SMALL-OUTLINE PACKAGE

14-PINS SHOWN

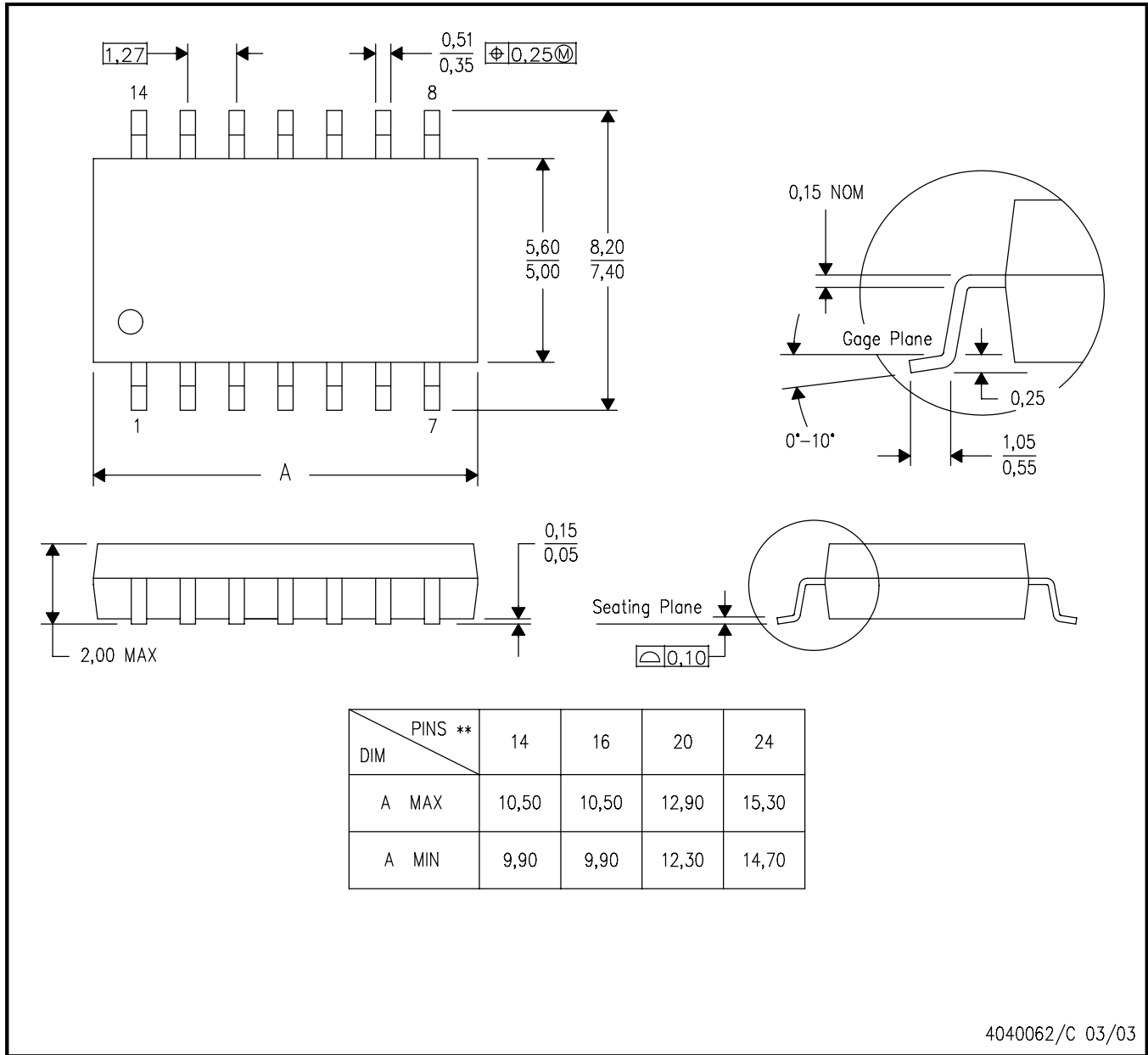



- NOTES:
- A. All linear dimensions are in millimeters.
  - B. This drawing is subject to change without notice.
  - C. Body dimensions do not include mold flash or protrusion, not to exceed 0,15.

PW (R-PDSO-G8)

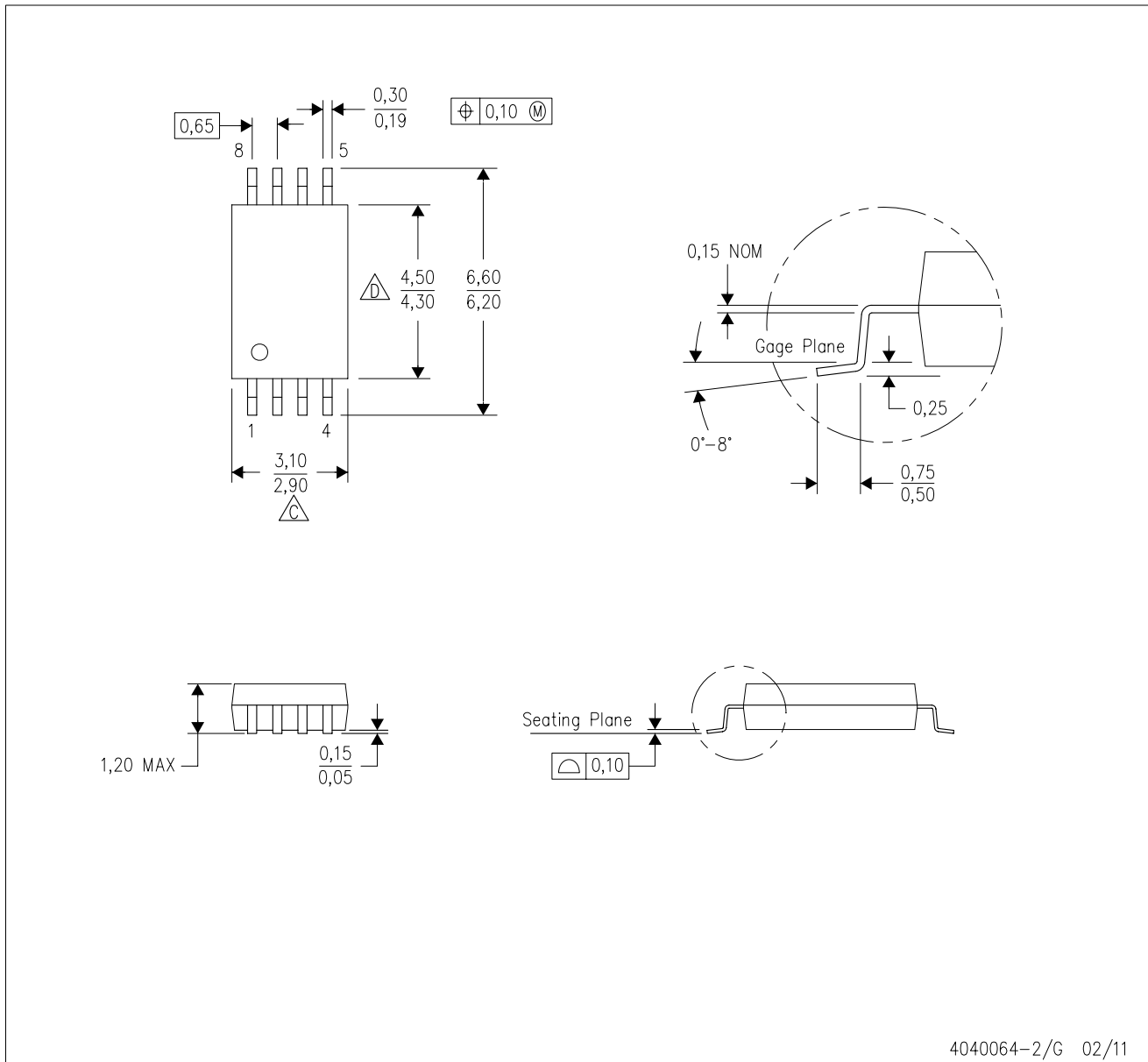
PLASTIC SMALL OUTLINE



- NOTES:
- A. All linear dimensions are in millimeters. Dimensioning and tolerancing per ASME Y14.5M-1994.
  - B. This drawing is subject to change without notice.
  -  C. Body length does not include mold flash, protrusions, or gate burrs. Mold flash, protrusions, or gate burrs shall not exceed 0,15 each side.
  -  D. Body width does not include interlead flash. Interlead flash shall not exceed 0,25 each side.
  - E. Falls within JEDEC MO-153

## IMPORTANT NOTICE

Texas Instruments Incorporated and its subsidiaries (TI) reserve the right to make corrections, modifications, enhancements, improvements, and other changes to its products and services at any time and to discontinue any product or service without notice. Customers should obtain the latest relevant information before placing orders and should verify that such information is current and complete. All products are sold subject to TI's terms and conditions of sale supplied at the time of order acknowledgment.

TI warrants performance of its hardware products to the specifications applicable at the time of sale in accordance with TI's standard warranty. Testing and other quality control techniques are used to the extent TI deems necessary to support this warranty. Except where mandated by government requirements, testing of all parameters of each product is not necessarily performed.

TI assumes no liability for applications assistance or customer product design. Customers are responsible for their products and applications using TI components. To minimize the risks associated with customer products and applications, customers should provide adequate design and operating safeguards.

TI does not warrant or represent that any license, either express or implied, is granted under any TI patent right, copyright, mask work right, or other TI intellectual property right relating to any combination, machine, or process in which TI products or services are used. Information published by TI regarding third-party products or services does not constitute a license from TI to use such products or services or a warranty or endorsement thereof. Use of such information may require a license from a third party under the patents or other intellectual property of the third party, or a license from TI under the patents or other intellectual property of TI.

Reproduction of TI information in TI data books or data sheets is permissible only if reproduction is without alteration and is accompanied by all associated warranties, conditions, limitations, and notices. Reproduction of this information with alteration is an unfair and deceptive business practice. TI is not responsible or liable for such altered documentation. Information of third parties may be subject to additional restrictions.

Resale of TI products or services with statements different from or beyond the parameters stated by TI for that product or service voids all express and any implied warranties for the associated TI product or service and is an unfair and deceptive business practice. TI is not responsible or liable for any such statements.

TI products are not authorized for use in safety-critical applications (such as life support) where a failure of the TI product would reasonably be expected to cause severe personal injury or death, unless officers of the parties have executed an agreement specifically governing such use. Buyers represent that they have all necessary expertise in the safety and regulatory ramifications of their applications, and acknowledge and agree that they are solely responsible for all legal, regulatory and safety-related requirements concerning their products and any use of TI products in such safety-critical applications, notwithstanding any applications-related information or support that may be provided by TI. Further, Buyers must fully indemnify TI and its representatives against any damages arising out of the use of TI products in such safety-critical applications.

TI products are neither designed nor intended for use in military/aerospace applications or environments unless the TI products are specifically designated by TI as military-grade or "enhanced plastic." Only products designated by TI as military-grade meet military specifications. Buyers acknowledge and agree that any such use of TI products which TI has not designated as military-grade is solely at the Buyer's risk, and that they are solely responsible for compliance with all legal and regulatory requirements in connection with such use.

TI products are neither designed nor intended for use in automotive applications or environments unless the specific TI products are designated by TI as compliant with ISO/TS 16949 requirements. Buyers acknowledge and agree that, if they use any non-designated products in automotive applications, TI will not be responsible for any failure to meet such requirements.

Following are URLs where you can obtain information on other Texas Instruments products and application solutions:

### Products

Audio	<a href="http://www.ti.com/audio">www.ti.com/audio</a>
Amplifiers	<a href="http://amplifier.ti.com">amplifier.ti.com</a>
Data Converters	<a href="http://dataconverter.ti.com">dataconverter.ti.com</a>
DLP® Products	<a href="http://www.dlp.com">www.dlp.com</a>
DSP	<a href="http://dsp.ti.com">dsp.ti.com</a>
Clocks and Timers	<a href="http://www.ti.com/clocks">www.ti.com/clocks</a>
Interface	<a href="http://interface.ti.com">interface.ti.com</a>
Logic	<a href="http://logic.ti.com">logic.ti.com</a>
Power Mgmt	<a href="http://power.ti.com">power.ti.com</a>
Microcontrollers	<a href="http://microcontroller.ti.com">microcontroller.ti.com</a>
RFID	<a href="http://www.ti-rfid.com">www.ti-rfid.com</a>
RF/IF and ZigBee® Solutions	<a href="http://www.ti.com/lprf">www.ti.com/lprf</a>

### Applications

Communications and Telecom	<a href="http://www.ti.com/communications">www.ti.com/communications</a>
Computers and Peripherals	<a href="http://www.ti.com/computers">www.ti.com/computers</a>
Consumer Electronics	<a href="http://www.ti.com/consumer-apps">www.ti.com/consumer-apps</a>
Energy and Lighting	<a href="http://www.ti.com/energy">www.ti.com/energy</a>
Industrial	<a href="http://www.ti.com/industrial">www.ti.com/industrial</a>
Medical	<a href="http://www.ti.com/medical">www.ti.com/medical</a>
Security	<a href="http://www.ti.com/security">www.ti.com/security</a>
Space, Avionics and Defense	<a href="http://www.ti.com/space-avionics-defense">www.ti.com/space-avionics-defense</a>
Transportation and Automotive	<a href="http://www.ti.com/automotive">www.ti.com/automotive</a>
Video and Imaging	<a href="http://www.ti.com/video">www.ti.com/video</a>
Wireless	<a href="http://www.ti.com/wireless-apps">www.ti.com/wireless-apps</a>

TI E2E Community Home Page

[e2e.ti.com](http://e2e.ti.com)

Mailing Address: Texas Instruments, Post Office Box 655303, Dallas, Texas 75265  
Copyright © 2011, Texas Instruments Incorporated