



## HIGH EFFICIENCY CLASS-G ADSL LINE DRIVER

### FEATURES

- **Low Total Power Consumption Increases ADSL Line Card Density (20 dBm on Line)**
  - 600 mW w/Active Termination (Full Bias)
  - 530 mW w/Active Termination (Low Bias)
- **Low MTPR of -74 dBc (All Bias Conditions)**
- **High Output Current of 500 mA (typ)**
- **Wide Supply Voltage Range of ±5 V to ±15 V [V<sub>CC(H)</sub>] and ±3.3 V to ±15 V [V<sub>CC(L)</sub>]**
- **Wide Output Voltage Swing of 43 V<sub>pp</sub> Into 100-Ω Differential Load [V<sub>CC(H)</sub> = ±12 V]**
- **Multiple Bias Modes Allow Low Quiescent Power Consumption for Short Line Lengths**
  - 160-mW/ch Full Bias Mode
  - 135-mW/ch Mid Bias Mode
  - 110-mW/ch Low Bias Mode
  - 75-mW/ch Terminate Only Mode
  - 13-mW/ch Shutdown Mode
- **Low Noise for Increased Receiver Sensitivity**
  - 3.3 pA/√Hz Noninverting Current Noise
  - 9.5 pA/√Hz Inverting Current Noise
  - 3.5 nV/√Hz Voltage Noise

### APPLICATIONS

- **Ideal for Active Termination Full Rate ADSL DMT applications (20-dBm Line Power)**

### DESCRIPTION

The THS6132 is a Class-G current feedback differential line driver ideal for full rate ADSL DMT systems. Its extremely low power consumption of 600 mW or lower is ideal for ADSL systems that must achieve high densities in ADSL central office rack applications. The unique patent pending architecture of the THS6132 allows the quiescent current to be much lower than existing line drivers while still achieving very high linearity. In addition, the multiple bias settings of the amplifiers allow for even lower power consumption for line lengths where the full performance of the amplifier is not required. The output voltage swing has been vastly improved over first generation Class-G amplifiers and allows the use of lower power supply voltages that help conserve power. For maximum flexibility, the THS6132 can be configured in classical Class-AB mode requiring only as few as one power supply.

### Typical ADSL CO Line Driver Circuit Utilizing Active Impedance Supporting A 6.3 Crest Factor

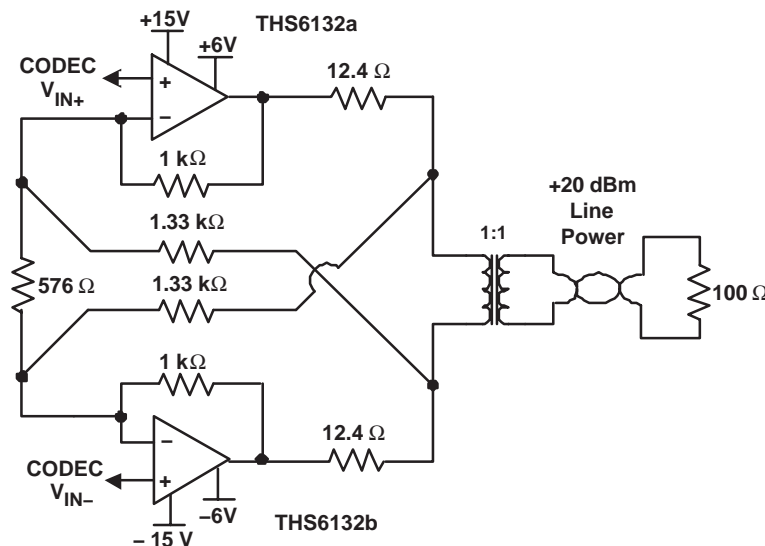

Please be aware that an important notice concerning availability, standard warranty, and use in critical applications of Texas Instruments semiconductor products and disclaimers thereto appears at the end of this data sheet.



These devices have limited built-in ESD protection. The leads should be shorted together or the device placed in conductive foam during storage or handling to prevent electrostatic damage.

## ORDERING INFORMATION

PRODUCT	PACKAGE	PACKAGE CODE	SYMBOL	T <sub>A</sub>	ORDER NUMBER	TRANSPORT MEDIA
THS6132VFP	TQFP-32 PowerPAD™	VFP-32	THS6132	-40°C to 85°C	THS6132VFP	Tube
					THS6132VFP	Tape and reel
THS6132RGW	Leadless 25-pin 5,mm x 5, mm PowerPAD™	RGW-25	6132		THS6132RGWR	Tape and reel

## PACKAGE DISSIPATION RATINGS

PACKAGE	Θ <sub>JA</sub>	Θ <sub>JC</sub>	T <sub>A</sub> ≤ 25°C POWER RATING(1)	T <sub>A</sub> = 70°C POWER RATING(1)	T <sub>A</sub> = 85°C POWER RATING(1)
VFP-32	29.4°C/W	0.96°C/W	3.57 W	2.04 W	1.53 W
RGW-25	31°C/W	1.7°C/W	3.39 W	1.94 W	1.45 W

(1) Power rating is determined with a junction temperature of 130°C. This is the point where distortion starts to substantially increase. Thermal management of the final PCB should strive to keep the junction temperature at or below 125°C for best performance.

## ABSOLUTE MAXIMUM RATINGS

over operating free-air temperature range unless otherwise noted(1)

		THS6132
Supply voltage, V <sub>CC(H)</sub> and V <sub>CC(L)</sub> (2)		±16.5 V
Input voltage, V <sub>I</sub>		±V <sub>CC(L)</sub>
Output current, I <sub>O</sub> (3)		900 mA
Differential input voltage, V <sub>IO</sub>		±2 V
Maximum junction temperature, T <sub>J</sub> (see Dissipation Rating Table for more information)		150°C
Operating free-air temperature, T <sub>A</sub>		-40°C to 85°C
Storage temperature, T <sub>Stg</sub>		65°C to 150°C
Lead temperature, 1,6 mm (1/16-inch) from case for 10 seconds		300°C
ESD ratings	HBM	1 kV
	CDM	500 V
	MM	200 V

(1) Stresses beyond those listed under “absolute maximum ratings” may cause permanent damage to the device. These are stress ratings only, and functional operation of the device at these or any other conditions beyond those indicated under “recommended operating conditions” is not implied. Exposure to absolute-maximum-rated conditions for extended periods may affect device reliability.

(2) V<sub>CC(H)</sub> must always be greater than or equal to V<sub>CC(L)</sub> for proper operation. Class-AB mode operation occurs when V<sub>CC(H)</sub> is equal to V<sub>CC(L)</sub> and is considered acceptable operation for the THS6132 even though it is not fully specified in this mode of operation.

(3) The THS6132 incorporates a PowerPAD on the underside of the chip. This acts as a heatsink and must be connected to a thermally dissipating plane for proper power dissipation. Failure to do so may result in exceeding the maximum junction temperature that could permanently damage the device. See TI Technical Brief SLMA002 for more information about utilizing the PowerPAD thermally enhanced package.

## RECOMMENDED OPERATING CONDITIONS

		MIN	NOM	MAX	UNIT
Supply voltage	+V <sub>CC(H)</sub> to -V <sub>CC(H)</sub>	±V <sub>CC(L)</sub>	±15	±16	V
	+V <sub>CC(L)</sub> to -V <sub>CC(L)</sub>	±3.3	±5	±V <sub>CC(H)</sub>	
Operating free-air temperature, T <sub>A</sub>		-40		85	°C

## ELECTRICAL CHARACTERISTICS

over recommended operating free-air temperature range, T<sub>A</sub> = 25°C, V<sub>CC(H)</sub> = ±15 V, V<sub>CC(L)</sub> = ±5 V R<sub>F</sub> = 1.5 kΩ, Gain = +10, Full Bias Mode, R<sub>L</sub> = 50 Ω (unless otherwise noted)

NOISE/DISTORTION PERFORMANCE							
PARAMETER		TEST CONDITIONS		MIN	TYP	MAX	UNIT
Multitone power ratio		Gain = +11, 163kHz to 1.1MHz DMT, +20 dBm Line Power, 1:1.1 transformer, active termination, synthesis factor = 4			-74		dBc
Receive band spill-over		Gain = +11, 25 kHz to 138 kHz with MTPR signal applied			-95		dBc
HD	Harmonic distortion (Differential Configuration, f = 1 MHz, V <sub>O(PP)</sub> = 2 V, Gain = +10)	2 <sup>nd</sup> harmonic	Differential load = 100 Ω		-84		dBc
			Differential load = 25 Ω		-69		
		3 <sup>rd</sup> harmonic	Differential load = 100 Ω		-92		dBc
			Differential load = 25 Ω		-73		
V <sub>n</sub>	Input voltage noise	f = 10 kHz			3.5		nV/√Hz
I <sub>n</sub>	Input current noise	+Input	f = 10 kHz			3.3	pA/√Hz
		-Input				9.5	
Crosstalk		f = 1 MHz, R <sub>L</sub> = 100 Ω,	V <sub>O(PP)</sub> = 2 V, Gain = +2		-52		dBc
OUTPUT CHARACTERISTICS							
V <sub>O</sub>	Single-ended output voltage swing	V <sub>CC(H)</sub> = ±12 V	R <sub>L</sub> = 100 Ω	±10.4	±10.8	V	
			R <sub>L</sub> = 30 Ω	±9.9	±10.4		
		V <sub>CC(H)</sub> = ±15 V	R <sub>L</sub> = 100 Ω	±13.3	±13.8	V	
			R <sub>L</sub> = 50 Ω	±13	±13.6		
Output voltage transition from V <sub>CC(L)</sub> to V <sub>CC(H)</sub> (Point where I <sub>CC(L)</sub> = I <sub>CC(H)</sub> )		R <sub>L</sub> = 50 Ω	V <sub>CC(L)</sub> = ±5 V	±3.1		V	
			V <sub>CC(L)</sub> = ±6 V	±3.9			
I <sub>O</sub>	Output current (1)	R <sub>L</sub> = 10 Ω	V <sub>CC(H)</sub> = ±12 V	±500		mA	
			V <sub>CC(H)</sub> = ±15 V	±400	±500		
I <sub>(SC)</sub>	Short-circuit current (1)	R <sub>L</sub> = 1 Ω	V <sub>CC(H)</sub> = ±15 V	±750		mA	
Output resistance		Open-loop		5		Ω	
Output resistance—terminate mode		f = 1 MHz,	Gain = +10	0.35		Ω	
Output resistance—shutdown mode		f = 1 MHz,	Open-loop	5.5		kΩ	

(1) A heatsink is required to keep the junction temperature below absolute maximum rating when an output is heavily loaded or shorted. See Absolute Maximum Ratings section for more information.

**ELECTRICAL CHARACTERISTICS (continued)**

over recommended operating free-air temperature range,  $T_A = 25^\circ\text{C}$ ,  $V_{CC(H)} = \pm 15\text{ V}$ ,  $V_{CC(L)} = \pm 5\text{ V}$   $R_F = 1.5\text{ k}\Omega$ , Gain = +10, Full Bias Mode,  $R_L = 50\ \Omega$  (unless otherwise noted)

POWER SUPPLY								
PARAMETER		TEST CONDITIONS		MIN	TYP	MAX	UNIT	
$V_{CC(x)}$	Operating range	$\pm V_{CC(H)}$		$\pm V_{CC(L)}$	$\pm 15$	$\pm 16.5$	V	
		$\pm V_{CC(L)}$		$\pm 3$	$\pm 5$	$\pm V_{CC(H)}$		
$I_{CC}$	Quiescent current (each driver) Full-bias mode (Bias-1 = 1, Bias-2 = 1, Bias-3 = X) ( $I_{CC}$ trimmed with $V_{CC(H)} = \pm 15\text{ V}$ , $V_{CC(L)} = \pm 5\text{ V}$ )	$V_{CC(L)} = \pm 5\text{ V};$ $(V_{CC(H)} = \pm 15\text{ V})$	$T_A = 25^\circ\text{C}$	5.7	6.4	7.5	mA	
			$T_A = \text{full range}$			8.1		
		$V_{CC(L)} = \pm 6\text{ V};$ $(V_{CC(H)} = \pm 15\text{ V})$	$T_A = 25^\circ\text{C}$		6.7		mA	
			$T_A = \text{full range}$					
		$V_{CC(H)} = \pm 12\text{ V};$ $(V_{CC(L)} = \pm 5\text{ V})$	$T_A = 25^\circ\text{C}$		3.1		mA	
			$T_A = \text{full range}$					
		$V_{CC(H)} = \pm 15\text{ V};$ $(V_{CC(L)} = \pm 5\text{ V})$	$T_A = 25^\circ\text{C}$	2.9	3.25	3.75	mA	
			$T_A = \text{full range}$			4.25		
	Quiescent current (each driver) Variable bias modes, $V_{CC(L)} = \pm 5\text{ V}$	Mid; Bias-1 = 1, Bias-2 = 0, Bias-3 = 1			5.0	5.6	6.8	mA
		Low; Bias-1 = 1, Bias-2 = 0, Bias-3 = 0			4.25	4.8	6.0	
		Terminate; Bias-1 = 0, Bias-2 = 1, Bias-3 = X <sup>(1)</sup>			3.2	3.8	4.5	
		Shutdown; Bias-1 = 0, Bias-2 = 0, Bias-3 = X <sup>(1)</sup>				1	1.3	
	Quiescent current (each driver) Variable bias modes, $V_{CC(H)} = \pm 15\text{ V}$	Mid; Bias-1 = 1, Bias-2 = 0, Bias-3 = 1			2.4	2.7	3.0	mA
		Low ; Bias-1 = 1, Bias-2 = 0, Bias-3 = 0			1.9	2.15	2.4	
		Terminate; Bias-1 = 0, Bias-2 = 1, Bias-3 = X <sup>(1)</sup>			1.1	1.3	1.5	
		Shutdown ; Bias-1 = 0, Bias-2 = 0, Bias-3 = X <sup>(1)</sup>				0.1	0.5	
PSRR	Power supply rejection ratio ( $\Delta V_{CC(x)} = \pm 1\text{ V}$ )	$V_{CC(L)} = \pm 5\text{ V}$	$T_A = 25^\circ\text{C}$	-70	-82	dB		
			$T_A = \text{full range}$	-68				
		$V_{CC(H)} = \pm 15\text{ V}$	$T_A = 25^\circ\text{C}$	-70	-82			
			$T_A = \text{full range}$	-68				

(1) X is used to denote a logic state of either 1 or 0.

**ELECTRICAL CHARACTERISTICS (continued)**

 over recommended operating free-air temperature range,  $T_A = 25^\circ\text{C}$ ,  $V_{CC(H)} = \pm 15\text{ V}$ ,  $V_{CC(L)} = \pm 5\text{ V}$ ,  $R_F = 1.5\text{ k}\Omega$ , Gain = +10, Full Bias Mode,  $R_L = 50\ \Omega$  (unless otherwise noted)

DYNAMIC PERFORMANCE							
PARAMETER		TEST CONDITIONS		MIN	TYP	MAX	UNIT
BW	Single-ended small-signal bandwidth (-3 dB), $V_O = 0.1\text{ V}_{\text{rms}}$	$R_L = 100\ \Omega$	Gain = +1, $R_F = 750\ \Omega$		80		MHz
			Gain = +2, $R_F = 620\ \Omega$		70		
			Gain = +5, $R_F = 500\ \Omega$		60		
			Gain = +10, $R_F = 1\text{ k}\Omega$		20		
		$R_L = 25\ \Omega$	Gain = +1, $R_F = 750\ \Omega$		60		MHz
			Gain = +2, $R_F = 620\ \Omega$		55		
			Gain = +5, $R_F = 500\ \Omega$		50		
			Gain = +10, $R_F = 1\text{ k}\Omega$		17		
SR	Single-ended slew-rate <sup>(1)</sup>	$V_O = 20\text{ V}_{\text{pp}}$ , Gain = +10			300		V/ $\mu\text{s}$

(1) Slew-rate is defined from the 25% to the 75% output levels

DC PERFORMANCE							
PARAMETER		TEST CONDITIONS		MIN	TYP	MAX	UNIT
$V_{OS}$	Input offset voltage	$V_{CC(L)} = \pm 5\text{ V}, \pm 6\text{ V}$	$T_A = 25^\circ\text{C}$		1	15	mV
			$T_A = \text{full range}$			20	
	Differential offset voltage		$T_A = 25^\circ\text{C}$		0.3	6	
			$T_A = \text{full range}$			8	
	Offset drift		$T_A = \text{full range}$		40		$\mu\text{V}/^\circ\text{C}$
$I_{IB}$	-Input bias current	$V_{CC(L)} = \pm 5\text{ V}, \pm 6\text{ V}$	$T_A = 25^\circ\text{C}$		1	15	$\mu\text{A}$
			$T_A = \text{full range}$			20	
	+ Input bias current		$T_A = 25^\circ\text{C}$		1.5	15	
			$T_A = \text{full range}$			20	
$Z_{OL}$	Open loop transimpedance	$R_L = 1\text{ k}\Omega$			2		M $\Omega$

**ELECTRICAL CHARACTERISTICS (continued)**

over recommended operating free-air temperature range,  $T_A = 25^\circ\text{C}$ ,  $V_{CC(H)} = \pm 15\text{ V}$ ,  $V_{CC(L)} = \pm 5\text{ V}$ ,  $R_F = 1.5\text{ k}\Omega$ , Gain = +10, Full Bias Mode,  $R_L = 50\ \Omega$  (unless otherwise noted)

INPUT CHARACTERISTICS							
PARAMETER		TEST CONDITIONS		MIN	TYP	MAX	UNIT
$V_{ICR}$	Input common-mode voltage range <sup>(1)</sup>	$V_{CC(L)} = \pm 5\text{ V}$	$T_A = 25^\circ\text{C}$	$\pm 2.7$	$\pm 3.0$	V	
			$T_A = \text{full range}$	$\pm 2.6$			
		$V_{CC(L)} = \pm 6\text{ V}$	$T_A = 25^\circ\text{C}$	$\pm 4.0$			
REF pin input voltage range	$V_{CC-(L)} = \pm 5\text{ V}$			$\pm 2.5$		V	
	$V_{CC(L)} = \pm 6\text{ V}$			$\pm 3.5$			
CMRR	Common-mode rejection ratio	$V_{CC(L)} = \pm 5\text{ V}, \pm 6\text{ V}$	$T_A = 25^\circ\text{C}$	60	67	dB	
			$T_A = \text{full range}$	57			
$R_I$	Input resistance	+ Input		800		$\text{k}\Omega$	
		- Input		45		$\Omega$	
$C_I$	Differential Input capacitance			1.2		pF	

(1) To conserve as much power as possible, the input stage of the THS6132 is powered from the  $V_{CC(L)}$  supplies and is limited by the  $V_{CC(L)}$  supply voltage. For Class-AB operation, connect the  $V_{CC(L)}$  supplies to  $V_{CC(H)}$ .

LOGIC CONTROL CHARACTERISTICS							
PARAMETER		TEST CONDITIONS		MIN	TYP	MAX	UNIT
$V_{IH}$	Bias pin voltage for logic 1	Relative to DGND pin voltage		2.0		V	
$V_{IL}$	Bias pin voltage for logic 0	Relative to DGND pin voltage		0.8		V	
$I_{IH}$	Bias pin current for logic 1	$V_{IH} = 5\text{ V}, \text{ DGND} = 0\text{ V}$		-0.1	-0.2	$\mu\text{A}$	
$I_{IL}$	Bias pin current for logic 0	$V_{IL} = 0\text{ V}, \text{ DGND} = 0\text{ V}$		-0.1	-0.2	$\mu\text{A}$	
Transition time—logic 0 to logic 1 <sup>(1)</sup>				0.1		$\mu\text{s}$	
Transition time—logic 1 to logic 0 <sup>(1)</sup>				0.2		$\mu\text{s}$	
DGND useable range				$-V_{CC(H)}$	$+V_{CC(H)} - 5$	V	

(1) Transition time is defined as the time from when the logic signal is applied to the time when the supply current has reached half its final value.

LOGIC TABLE					
BIAS-1	BIAS-2	BIAS-3	FUNCTION	DESCRIPTION	
1	1	X <sup>(1)</sup>	Full bias mode	Amplifiers ON with lowest distortion possible	
1	0	1	Mid bias mode	Amplifiers ON with power savings with a reduction in distortion performance	
1	0	0	Low bias mode	Amplifiers ON with enhanced power savings and a reduction of distortion performance	
0	1	X <sup>(1)</sup>	Terminate mode	Lowest power state with +Vin pins internally connect to REF pin and output has low impedance	
0	0	X <sup>(1)</sup>	Shutdown mode	Amplifiers OFF and output has high impedance	

(1) X is used to denote a logic state of either 1 or 0.

NOTE: The default state for all logic pins is a logic one (1).

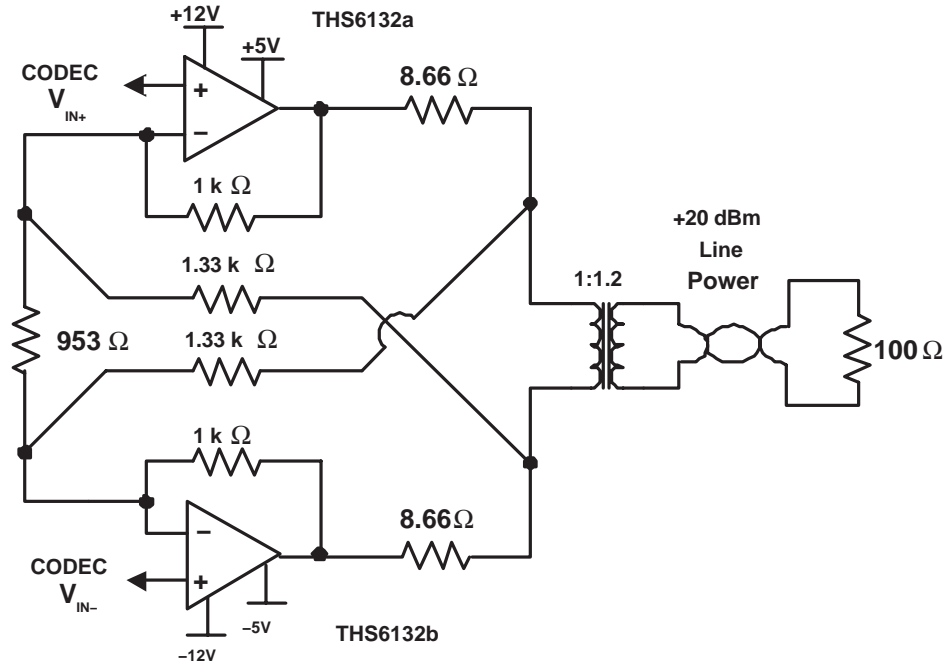
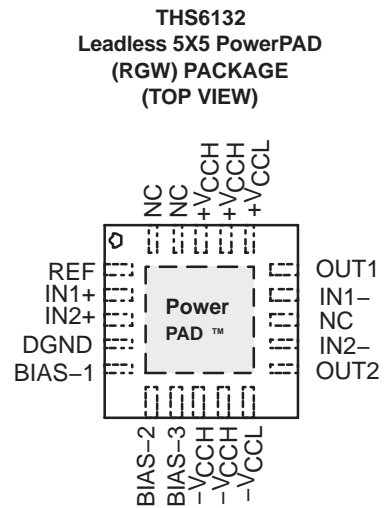
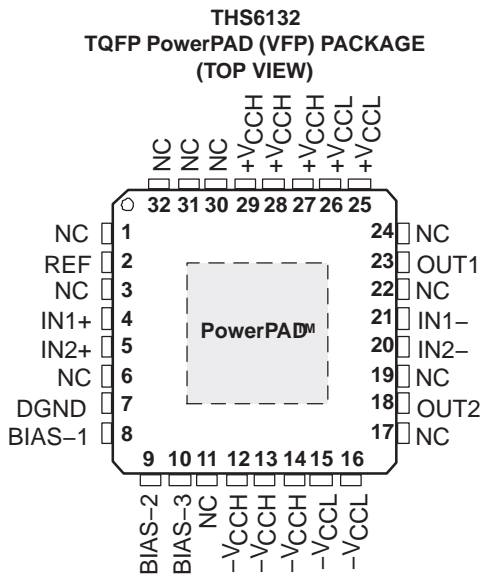

Figure 1.  $\pm 12$  V Active Termination ADSL CO Line Driver Circuit (Synthesis Factor = 4; CF = 5.6)

## PIN ASSIGNMENTS



TYPICAL CHARACTERISTICS

Table of Graphs

		FIGURE
Output voltage headroom	vs Output current	2
Common-mode rejection ratio	vs Frequency	3
Crosstalk	vs Frequency	4
Quiescent current	vs Temperature	5, 6
Large signal bandwidth	vs Frequency	7 – 10
Noise	vs Frequency	11
Overdrive recovery		12
Power supply rejection ratio	vs Frequency	13
Small signal frequency response		14, 15, 16
Small signal bandwidth	vs Frequency	17 – 28
Slew rate	vs Output voltage	29
Closed-loop output impedance	vs Frequency	30, 31
Shutdown response		32
Common-mode rejection ratio	vs Common-mode input voltage	33
Input bias current	vs Temperature	34
Input offset voltage	vs Temperature	35
Current draw distribution	vs Output voltage	36, 37
Output voltage	vs Temperature	38
Differential distortion	vs Frequency	39 – 52
Differential distortion	vs Differential output voltage	53 – 63
Single ended distortion	vs Frequency	64, 65

OUTPUT VOLTAGE HEADROOM  
vs  
OUTPUT CURRENT

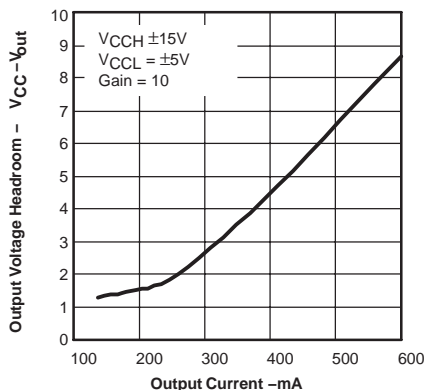

Figure 2

COMMON-MODE REJECTION RATIO  
vs  
FREQUENCY

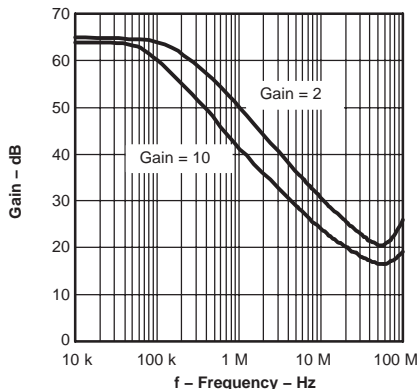

Figure 3

CROSSTALK  
vs  
FREQUENCY

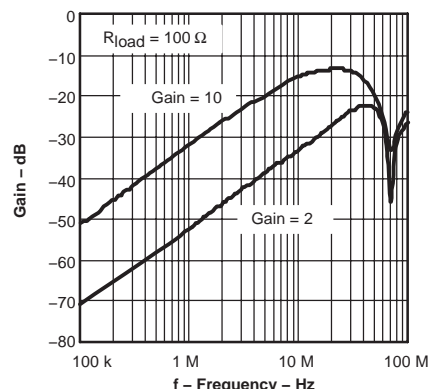

Figure 4

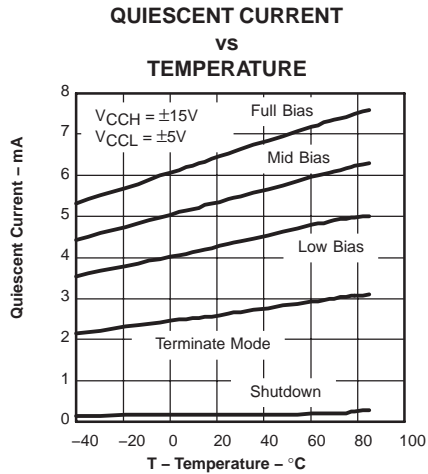

Figure 5

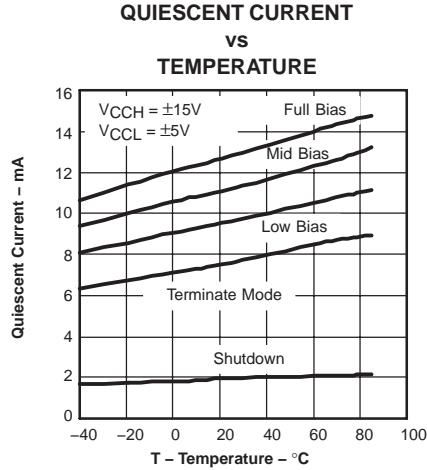

Figure 6

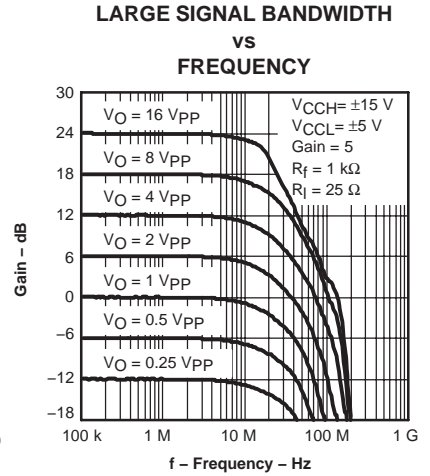

Figure 7

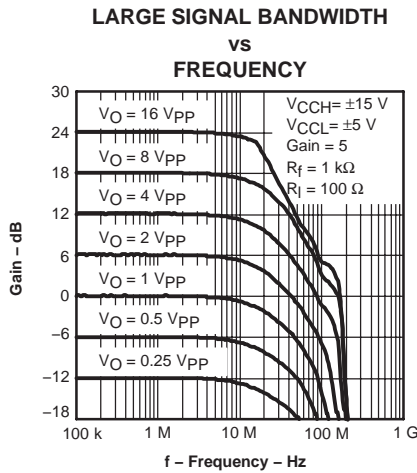

Figure 8

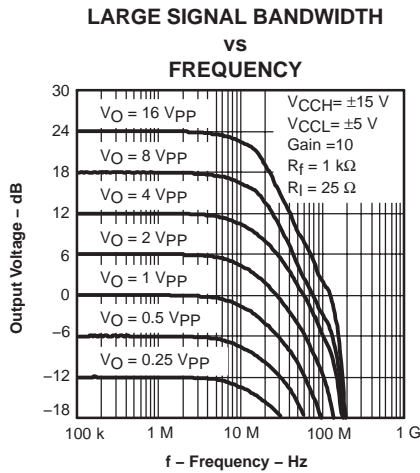

Figure 9

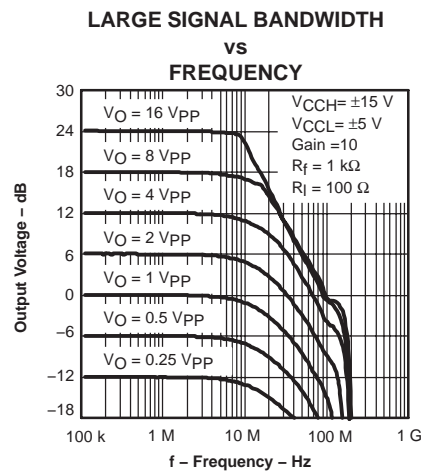

Figure 10

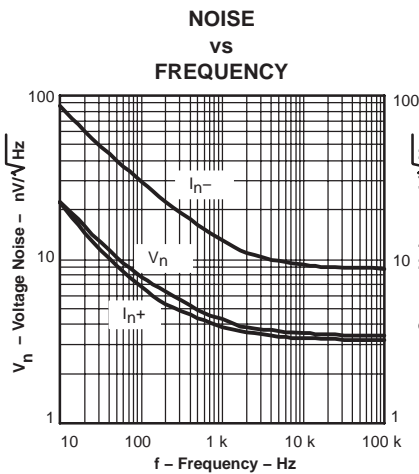

Figure 11

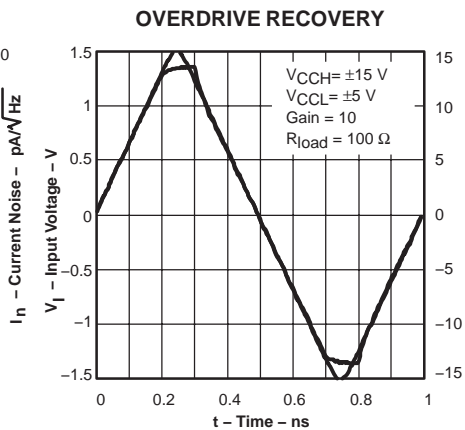

Figure 12

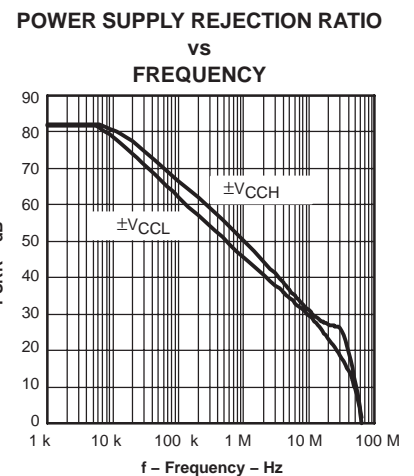

Figure 13

SMALL SIGNAL FREQUENCY RESPONSE

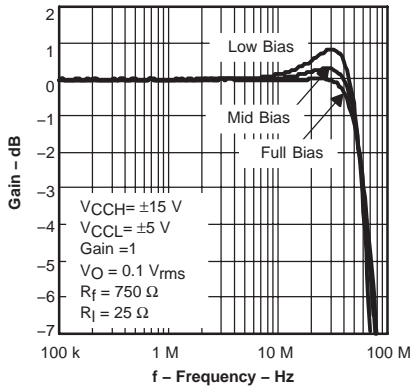

Figure 14

SMALL SIGNAL FREQUENCY RESPONSE

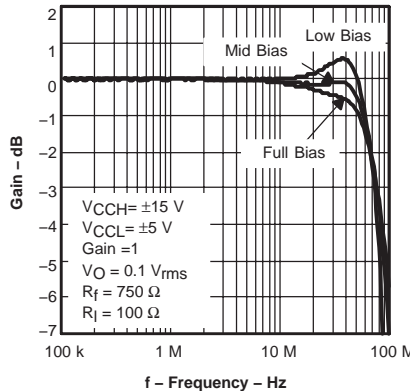

Figure 15

SMALL SIGNAL FREQUENCY RESPONSE

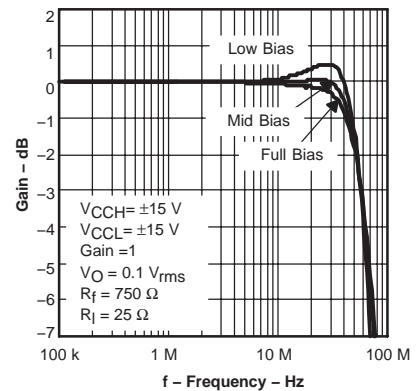

Figure 16

SMALL SIGNAL BANDWIDTH  
vs  
FREQUENCY

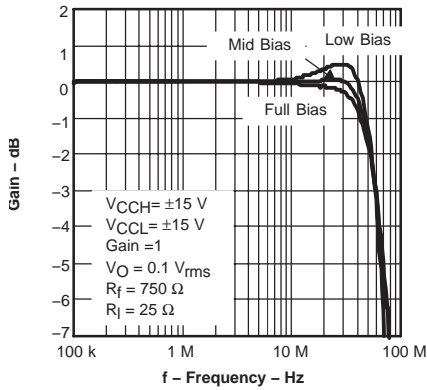

Figure 17

SMALL SIGNAL BANDWIDTH  
vs  
FREQUENCY

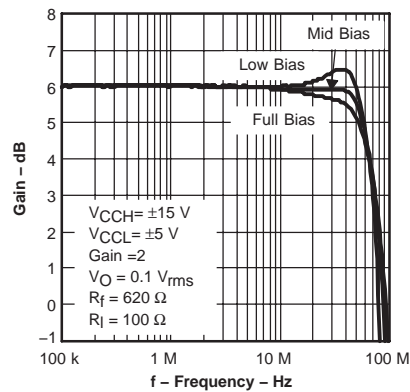

Figure 18

SMALL SIGNAL BANDWIDTH  
vs  
FREQUENCY

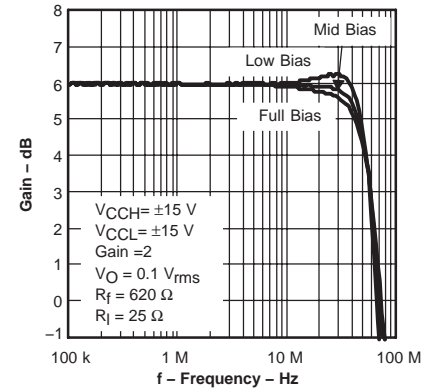

Figure 19

SMALL SIGNAL BANDWIDTH  
vs  
FREQUENCY

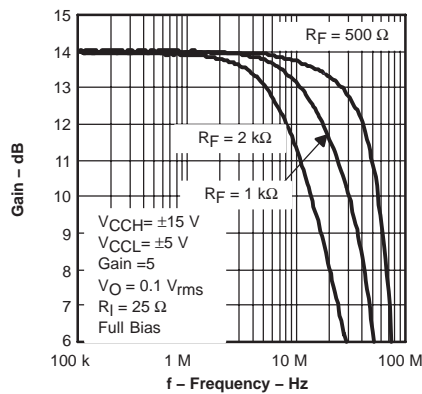

Figure 20

SMALL SIGNAL BANDWIDTH  
vs  
FREQUENCY

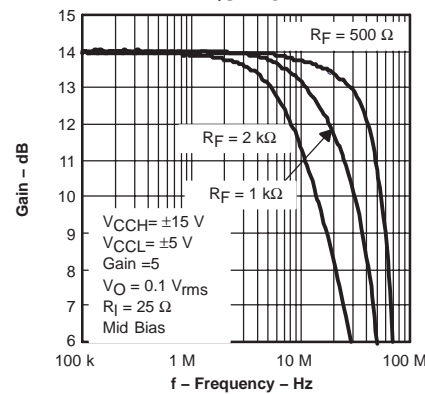

Figure 21

SMALL SIGNAL BANDWIDTH  
vs  
FREQUENCY

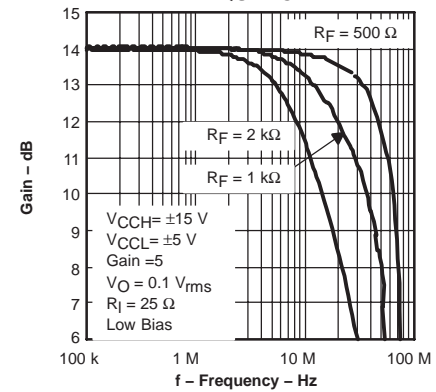

Figure 22

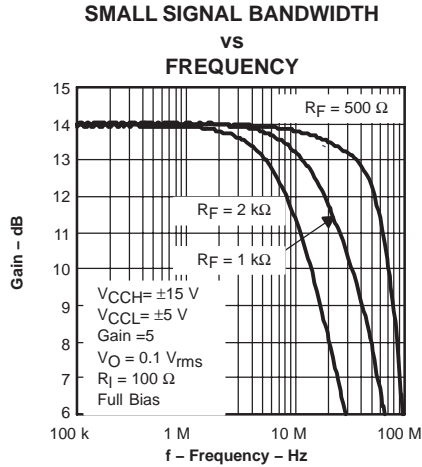

Figure 23

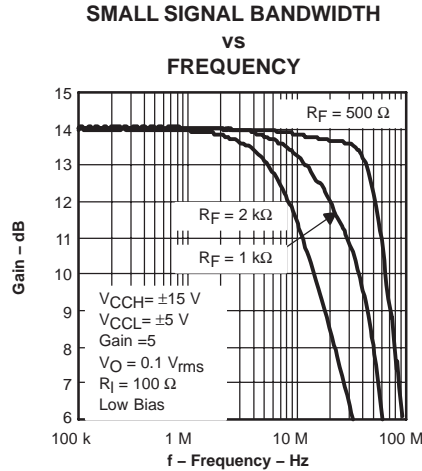

Figure 24

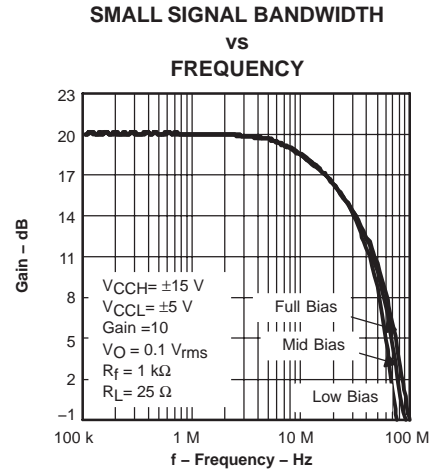

Figure 25

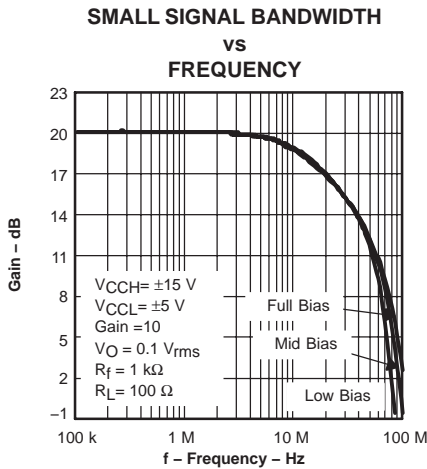

Figure 26

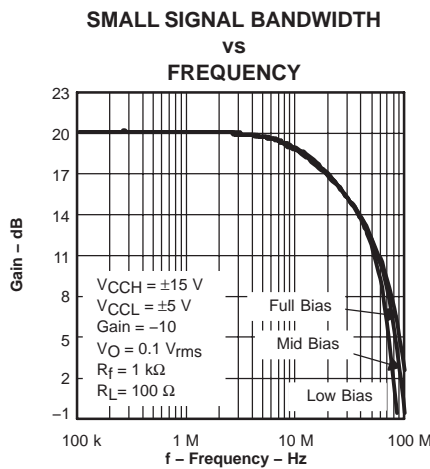

Figure 27

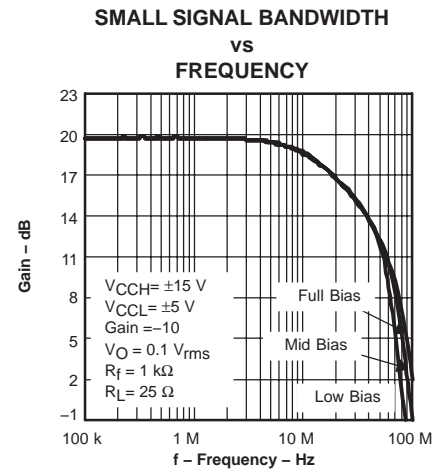

Figure 28

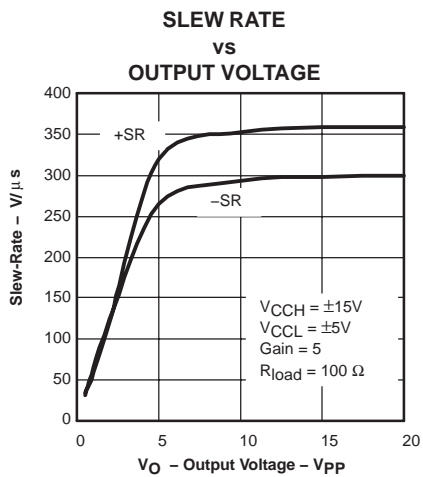

Figure 29

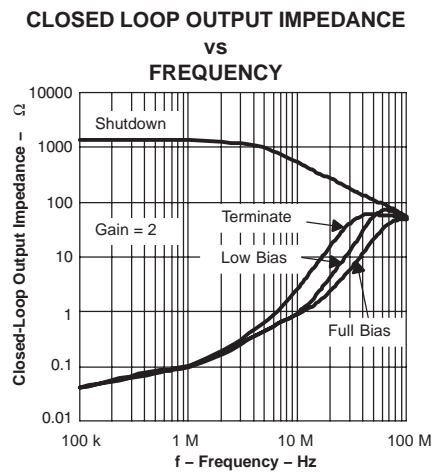

Figure 30

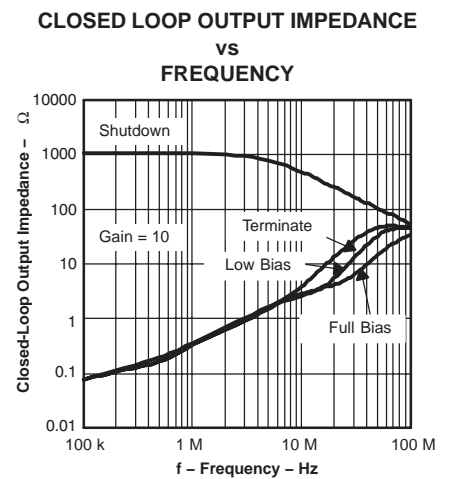

Figure 31

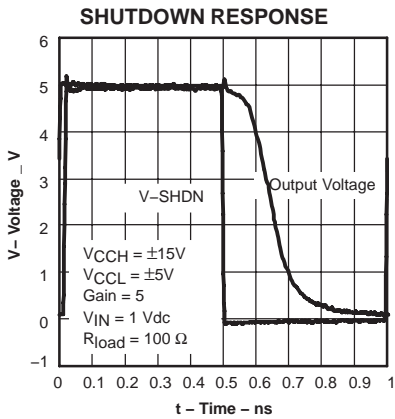

Figure 32

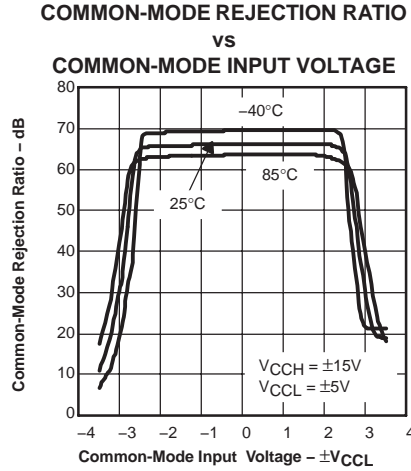

Figure 33

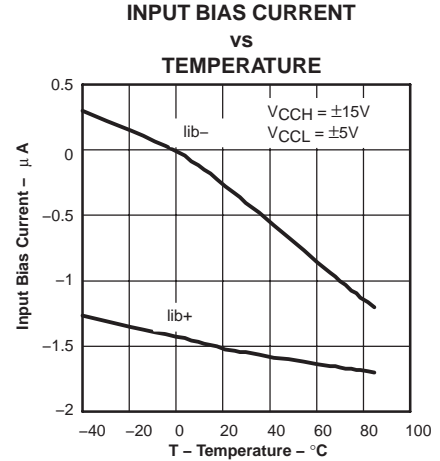

Figure 34

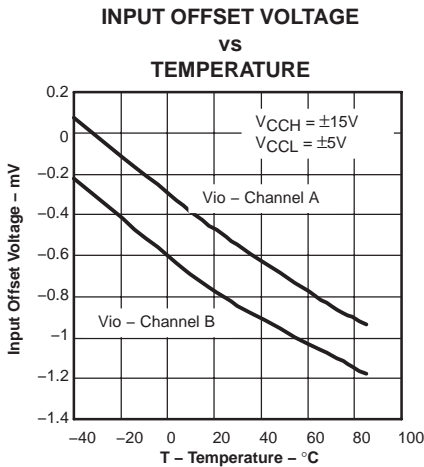

Figure 35

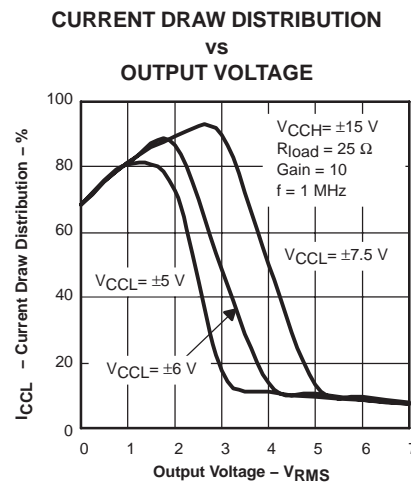

Figure 36

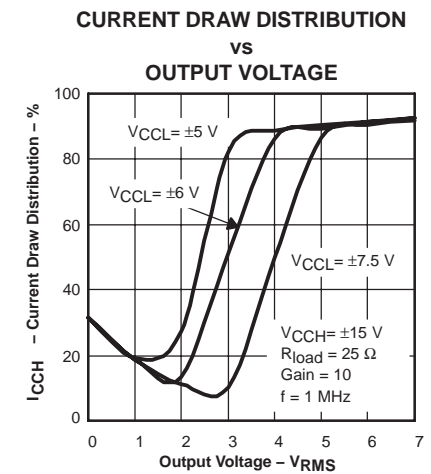

Figure 37

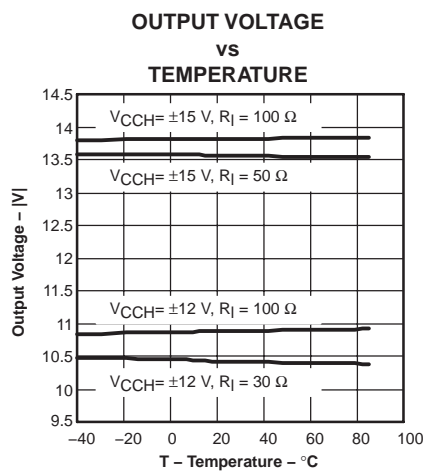

Figure 38

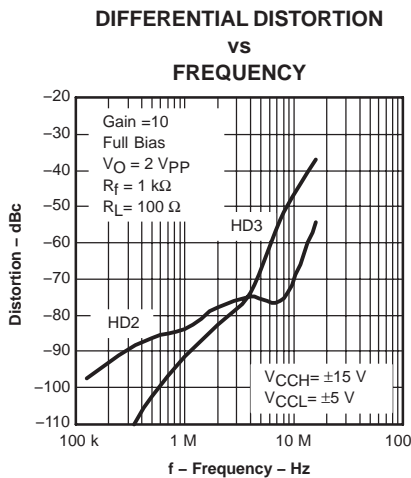

Figure 39

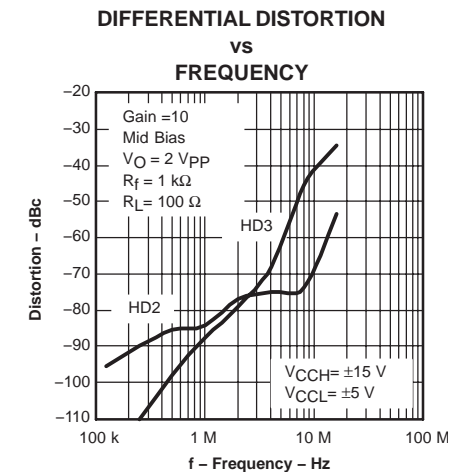

Figure 40

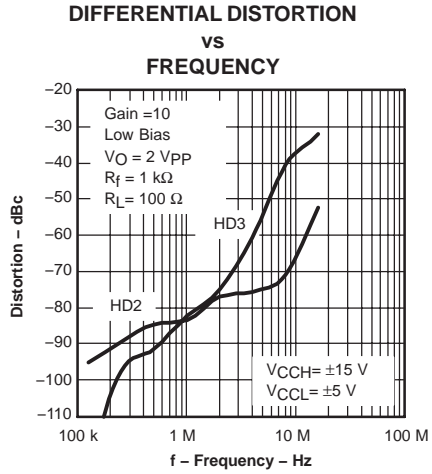

Figure 41

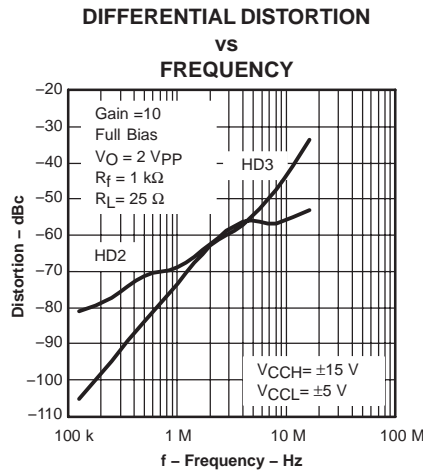

Figure 42

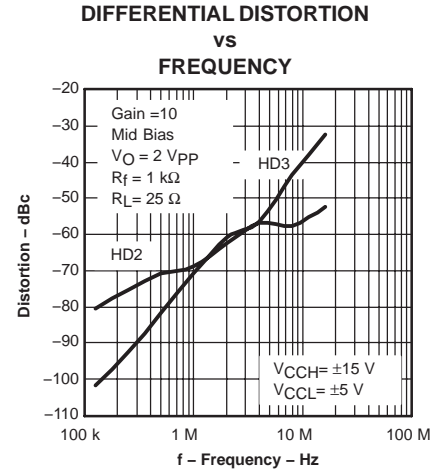

Figure 43

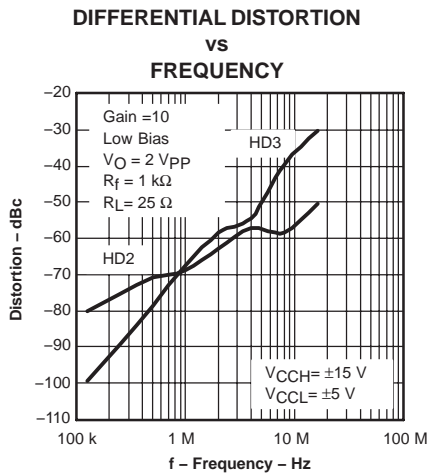

Figure 44

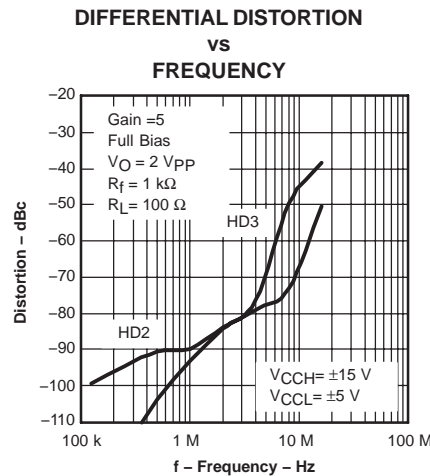

Figure 45

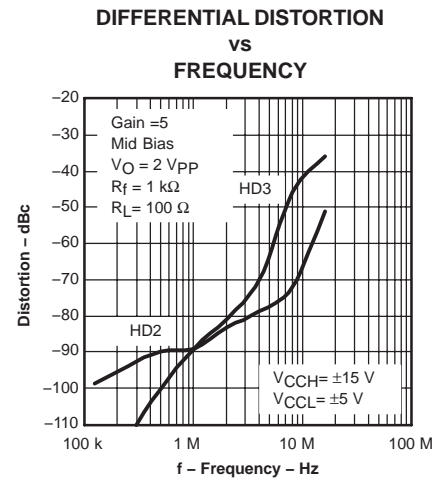

Figure 46

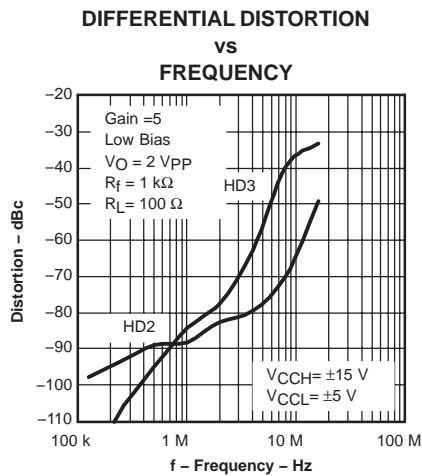

Figure 47

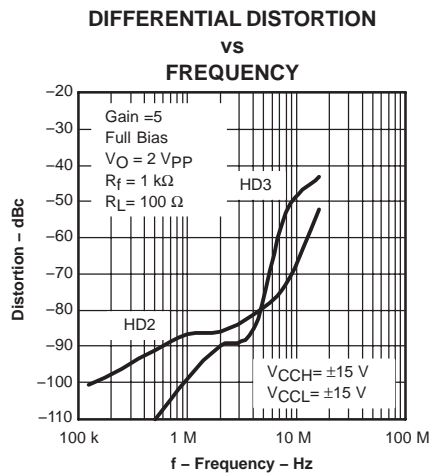

Figure 48

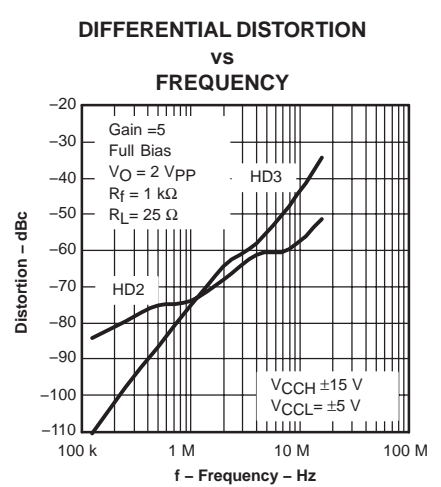

Figure 49

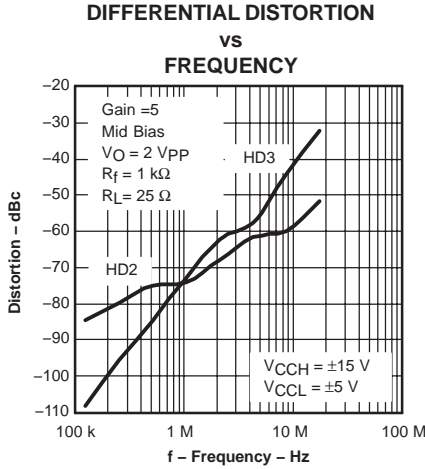

Figure 50

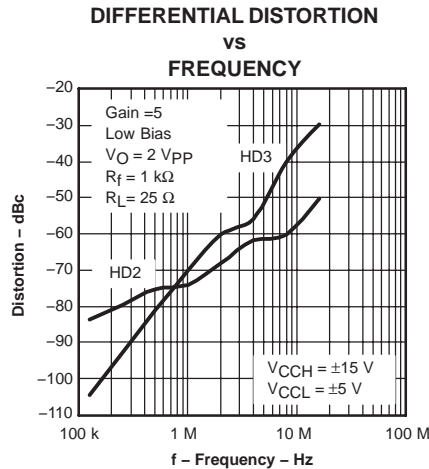

Figure 51

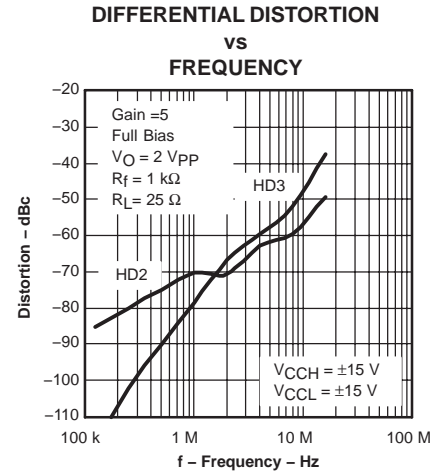

Figure 52

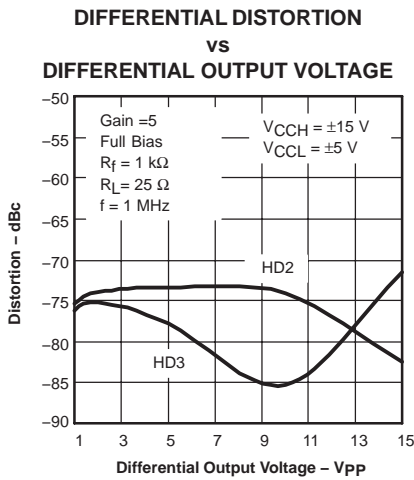

Figure 53

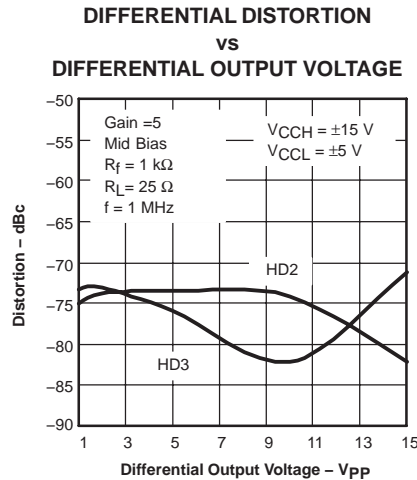

Figure 54

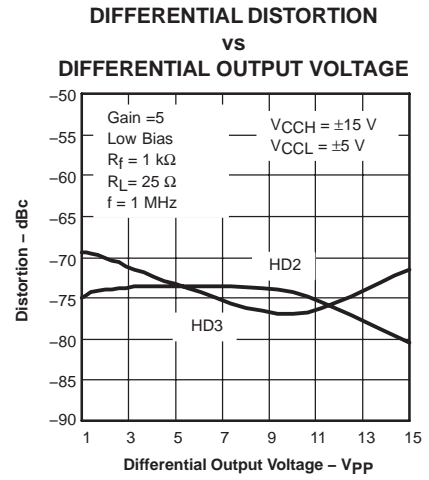

Figure 55

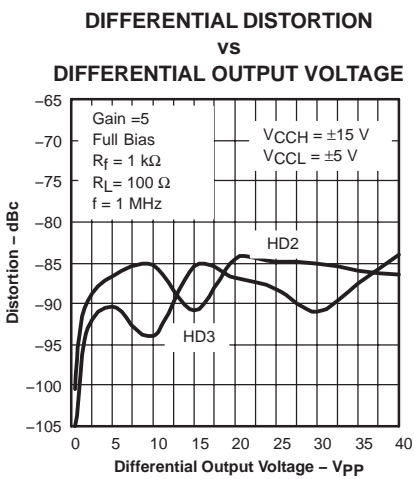

Figure 56

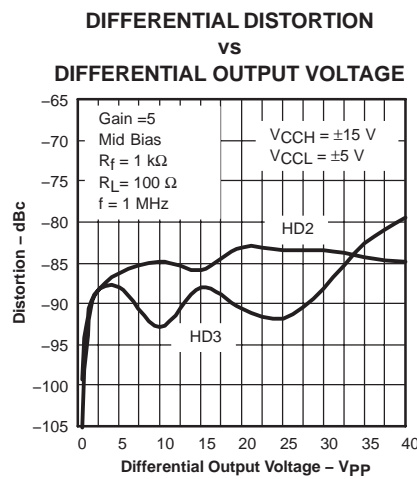

Figure 57

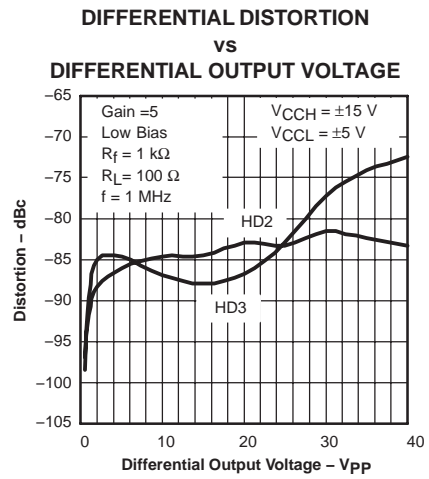

Figure 58

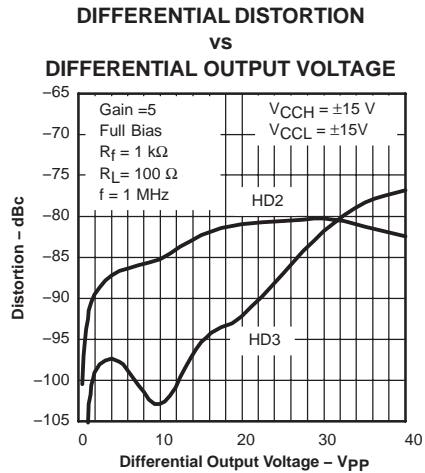

Figure 59

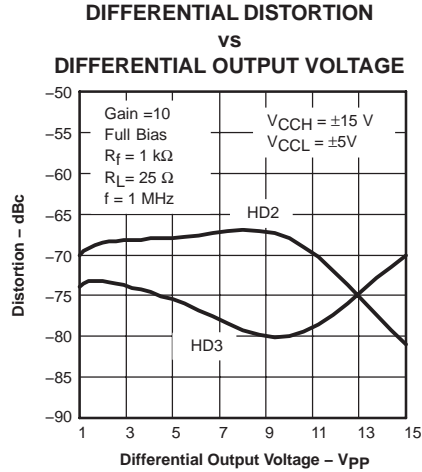

Figure 60

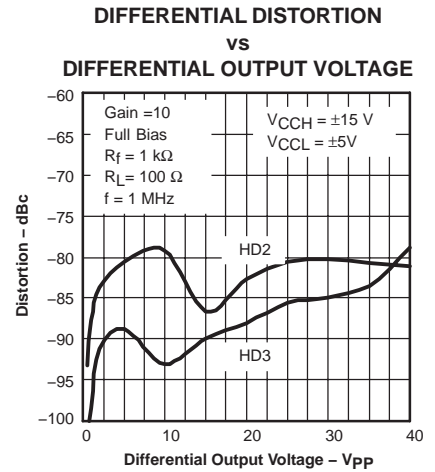

Figure 61

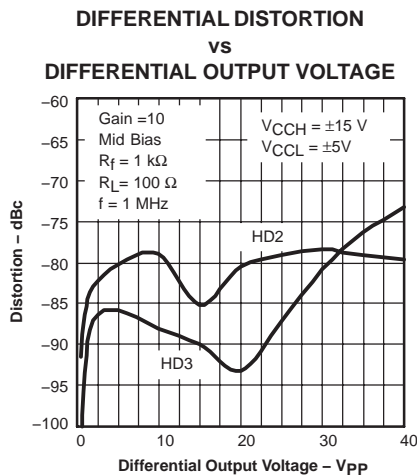

Figure 62

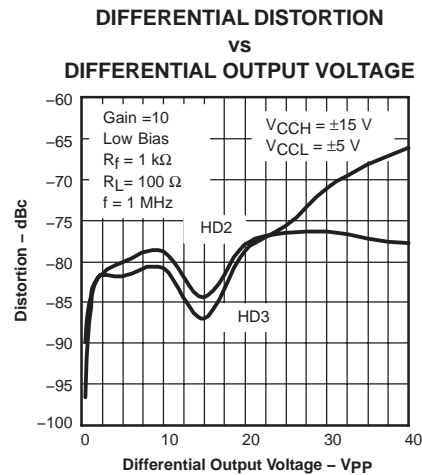

Figure 63

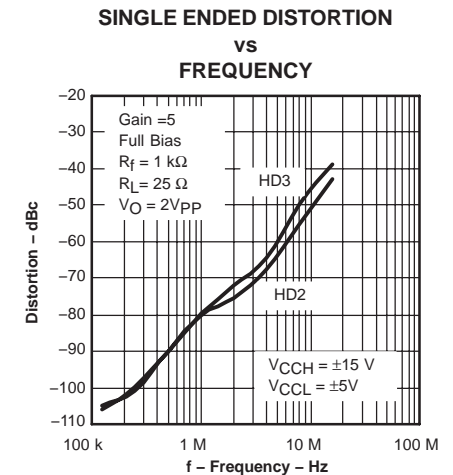

Figure 64

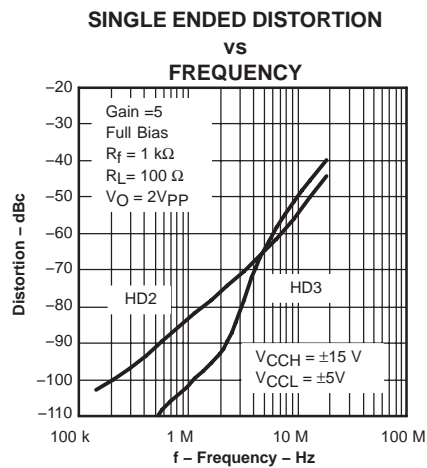

Figure 65

**PACKAGING INFORMATION**

Orderable Device	Status (1)	Package Type	Package Drawing	Pins	Package Qty	Eco Plan (2)	Lead/Ball Finish (6)	MSL Peak Temp (3)	Op Temp (°C)	Device Marking (4/5)	Samples
THS6132RGWR	ACTIVE	VQFN	RGW	20	3000	Green (RoHS & no Sb/Br)	CU NIPDAU	Level-2-260C-1 YEAR	-40 to 85	6132	<a href="#">Samples</a>
THS6132VFP	ACTIVE	HLQFP	VFP	32	250	Green (RoHS & no Sb/Br)	CU NIPDAU	Level-2-260C-1 YEAR	-40 to 85	THS6132	<a href="#">Samples</a>
THS6132VFPG4	ACTIVE	HLQFP	VFP	32		TBD	Call TI	Call TI	-40 to 85		<a href="#">Samples</a>

(1) The marketing status values are defined as follows:

**ACTIVE:** Product device recommended for new designs.

**LIFEBUY:** TI has announced that the device will be discontinued, and a lifetime-buy period is in effect.

**NRND:** Not recommended for new designs. Device is in production to support existing customers, but TI does not recommend using this part in a new design.

**PREVIEW:** Device has been announced but is not in production. Samples may or may not be available.

**OBSELETE:** TI has discontinued the production of the device.

(2) Eco Plan - The planned eco-friendly classification: Pb-Free (RoHS), Pb-Free (RoHS Exempt), or Green (RoHS & no Sb/Br) - please check <http://www.ti.com/productcontent> for the latest availability information and additional product content details.

**TBD:** The Pb-Free/Green conversion plan has not been defined.

**Pb-Free (RoHS):** TI's terms "Lead-Free" or "Pb-Free" mean semiconductor products that are compatible with the current RoHS requirements for all 6 substances, including the requirement that lead not exceed 0.1% by weight in homogeneous materials. Where designed to be soldered at high temperatures, TI Pb-Free products are suitable for use in specified lead-free processes.

**Pb-Free (RoHS Exempt):** This component has a RoHS exemption for either 1) lead-based flip-chip solder bumps used between the die and package, or 2) lead-based die adhesive used between the die and leadframe. The component is otherwise considered Pb-Free (RoHS compatible) as defined above.

**Green (RoHS & no Sb/Br):** TI defines "Green" to mean Pb-Free (RoHS compatible), and free of Bromine (Br) and Antimony (Sb) based flame retardants (Br or Sb do not exceed 0.1% by weight in homogeneous material)

(3) MSL, Peak Temp. - The Moisture Sensitivity Level rating according to the JEDEC industry standard classifications, and peak solder temperature.

(4) There may be additional marking, which relates to the logo, the lot trace code information, or the environmental category on the device.

(5) Multiple Device Markings will be inside parentheses. Only one Device Marking contained in parentheses and separated by a "~" will appear on a device. If a line is indented then it is a continuation of the previous line and the two combined represent the entire Device Marking for that device.

(6) Lead/Ball Finish - Orderable Devices may have multiple material finish options. Finish options are separated by a vertical ruled line. Lead/Ball Finish values may wrap to two lines if the finish value exceeds the maximum column width.

**Important Information and Disclaimer:** The information provided on this page represents TI's knowledge and belief as of the date that it is provided. TI bases its knowledge and belief on information provided by third parties, and makes no representation or warranty as to the accuracy of such information. Efforts are underway to better integrate information from third parties. TI has taken and

continues to take reasonable steps to provide representative and accurate information but may not have conducted destructive testing or chemical analysis on incoming materials and chemicals. TI and TI suppliers consider certain information to be proprietary, and thus CAS numbers and other limited information may not be available for release.

In no event shall TI's liability arising out of such information exceed the total purchase price of the TI part(s) at issue in this document sold by TI to Customer on an annual basis.

**TAPE AND REEL INFORMATION**
**REEL DIMENSIONS**

**TAPE DIMENSIONS**

A0	Dimension designed to accommodate the component width
B0	Dimension designed to accommodate the component length
K0	Dimension designed to accommodate the component thickness
W	Overall width of the carrier tape
P1	Pitch between successive cavity centers

**TAPE AND REEL INFORMATION**

\*All dimensions are nominal

Device	Package Type	Package Drawing	Pins	SPQ	Reel Diameter (mm)	Reel Width W1 (mm)	A0 (mm)	B0 (mm)	K0 (mm)	P1 (mm)	W (mm)	Pin1 Quadrant
THS6132RGWR	VQFN	RGW	20	3000	330.0	12.4	5.3	5.3	1.5	8.0	12.0	Q2

TAPE AND REEL BOX DIMENSIONS



\*All dimensions are nominal

Device	Package Type	Package Drawing	Pins	SPQ	Length (mm)	Width (mm)	Height (mm)
THS6132RGWR	VQFN	RGW	20	3000	338.1	338.1	20.6

VFP (S-PQFP-G32)

PowerPAD™ PLASTIC QUAD FLATPACK

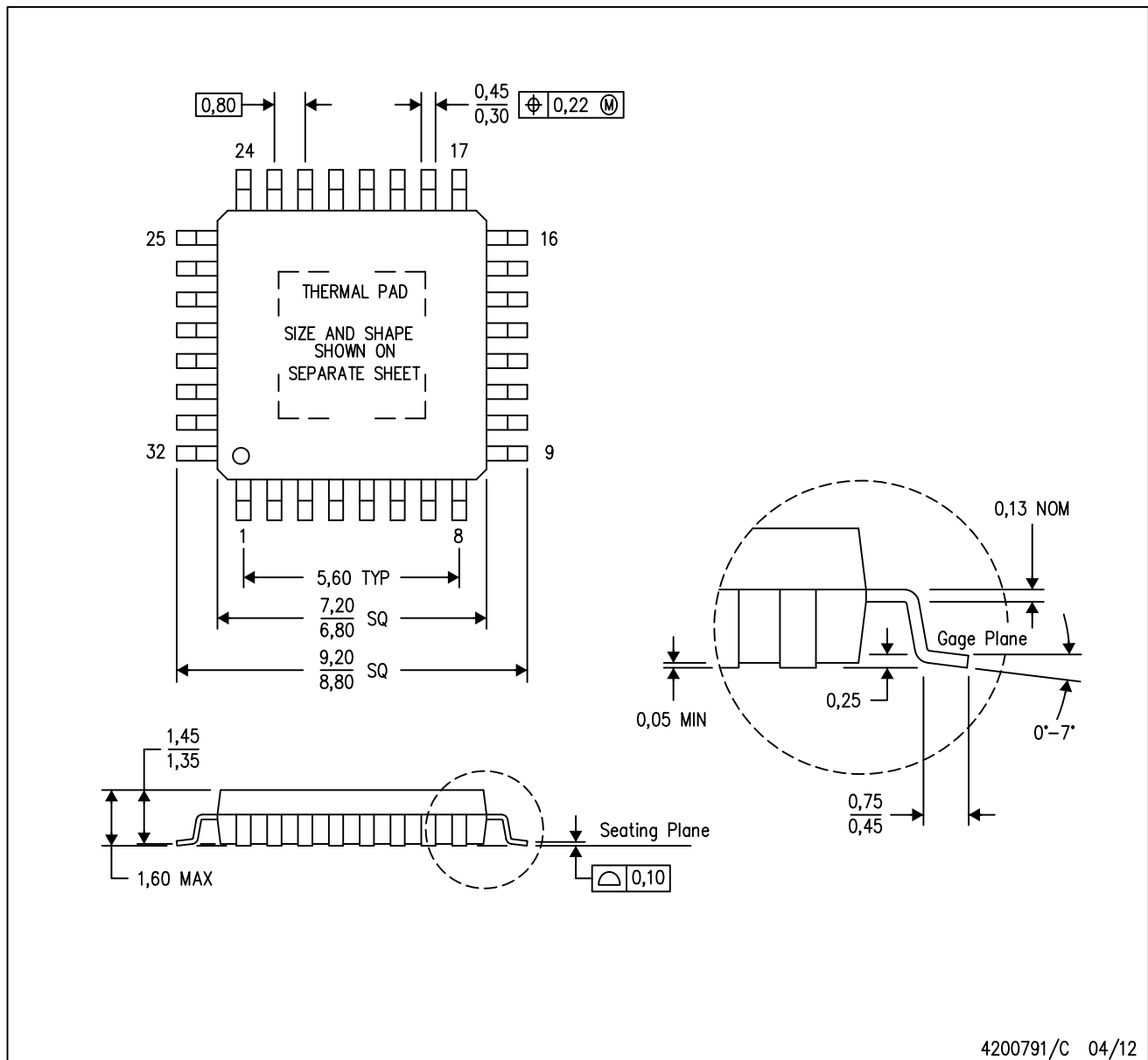

- NOTES:
- A. All linear dimensions are in millimeters.
  - B. This drawing is subject to change without notice.
  - C. Body dimensions do not include mold flash or protrusion.
  - D. This package is designed to be soldered to a thermal pad on the board. Refer to Technical Brief, PowerPad Thermally Enhanced Package, Texas Instruments Literature No. SLMA002 for information regarding recommended board layout. This document is available at [www.ti.com](http://www.ti.com) <<http://www.ti.com>>.
  - E. See the additional figure in the Product Data Sheet for details regarding the exposed thermal pad features and dimensions.
  - F. Falls within JEDEC MS-026

PowerPAD is a trademark of Texas Instruments Incorporated.

# THERMAL PAD MECHANICAL DATA

VFP (S-PQFP-G32)

PowerPAD™ PLASTIC QUAD FLATPACK

## THERMAL INFORMATION

This PowerPAD™ package incorporates an exposed thermal pad that is designed to be attached to a printed circuit board (PCB). The thermal pad must be soldered directly to the PCB. After soldering, the PCB can be used as a heatsink. In addition, through the use of thermal vias, the thermal pad can be attached directly to the appropriate copper plane shown in the electrical schematic for the device, or alternatively, can be attached to a special heatsink structure designed into the PCB. This design optimizes the heat transfer from the integrated circuit (IC).

For additional information on the PowerPAD package and how to take advantage of its heat dissipating abilities, refer to Technical Brief, PowerPAD Thermally Enhanced Package, Texas Instruments Literature No. SLMA002 and Application Brief, PowerPAD Made Easy, Texas Instruments Literature No. SLMA004. Both documents are available at [www.ti.com](http://www.ti.com).

The exposed thermal pad dimensions for this package are shown in the following illustration.

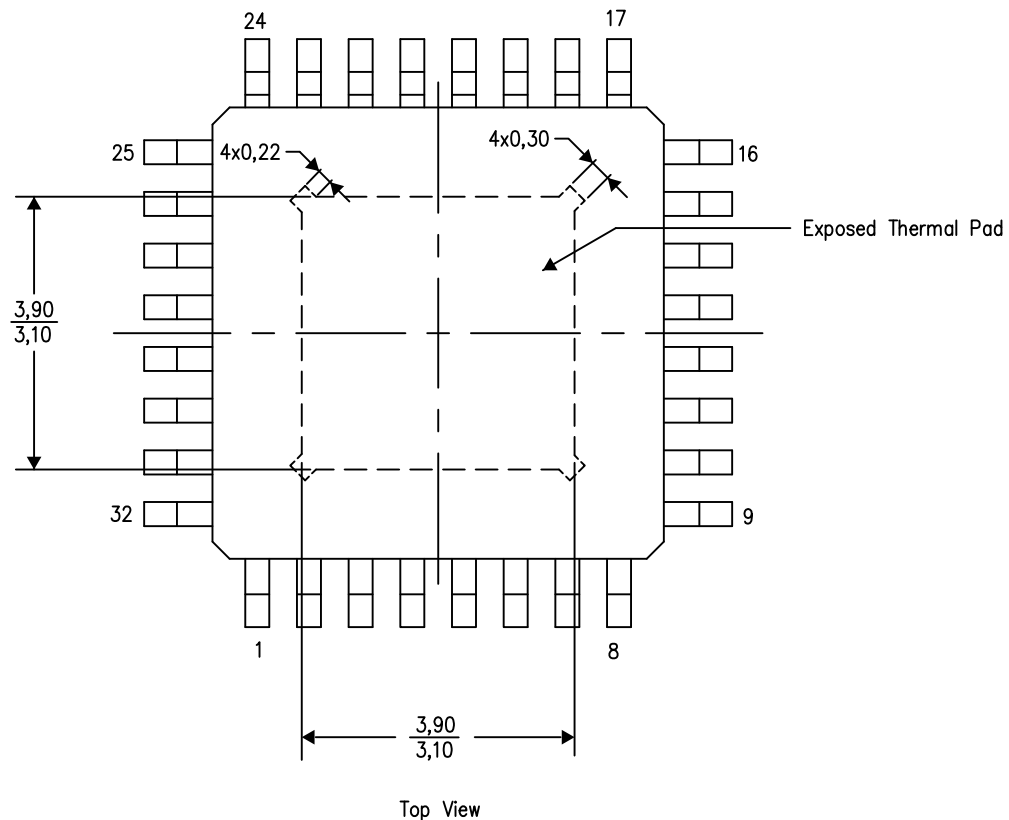

Exposed Thermal Pad Dimensions

4206318-2/E 06/13

NOTE: All linear dimensions are in millimeters

## VFP (S-PQFP-G32) PowerPAD™

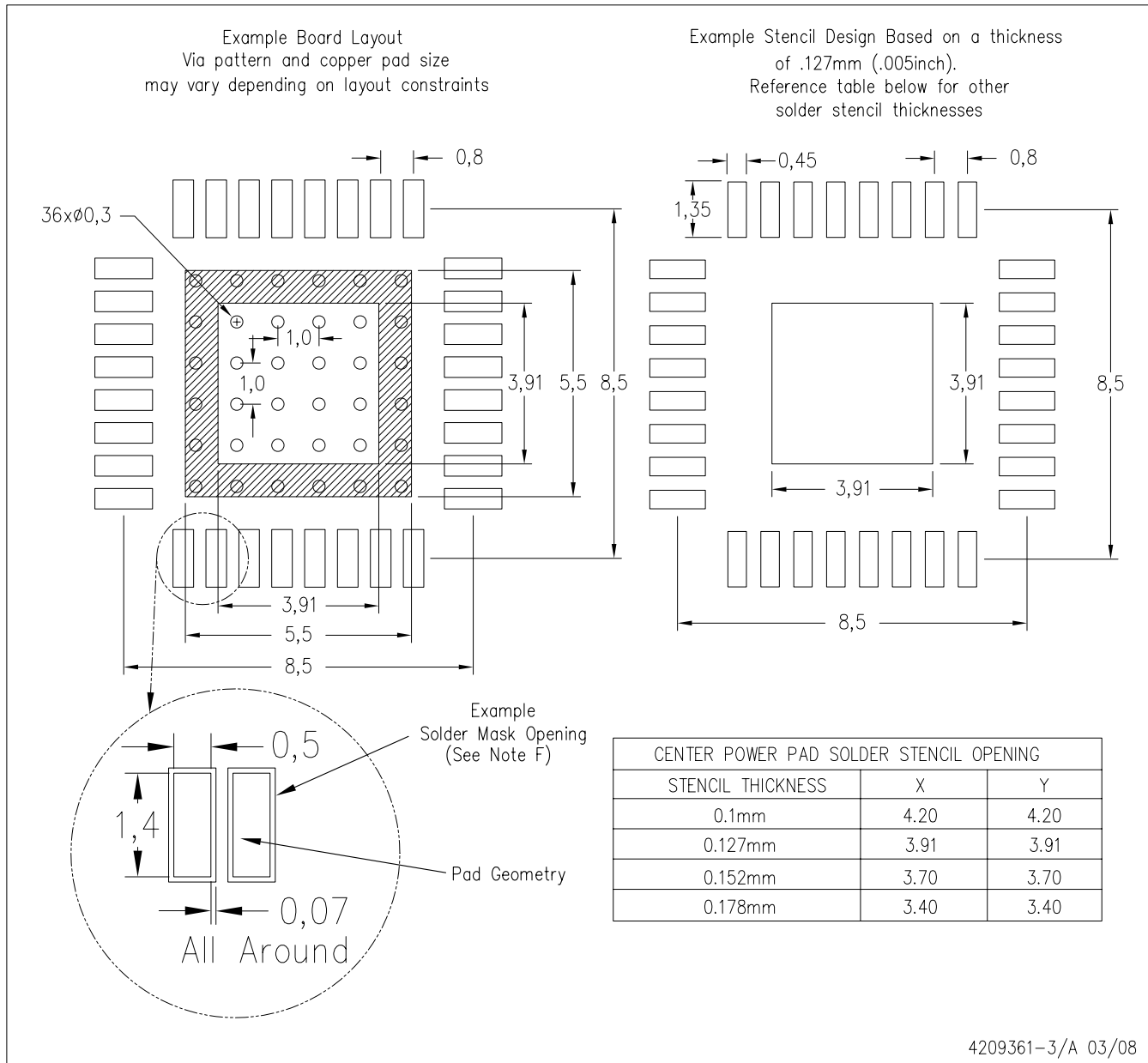

- NOTES:
- A. All linear dimensions are in millimeters.
  - B. This drawing is subject to change without notice.
  - C. Customers should place a note on the circuit board fabrication drawing not to alter the center solder mask defined pad.
  - D. This package is designed to be soldered to a thermal pad on the board. Refer to Technical Brief, PowerPAD Thermally Enhanced Package, Texas Instruments Literature No. SLMA002, SLMA004, and also the Product Data Sheets for specific thermal information, via requirements, and recommended board layout. These documents are available at [www.ti.com](http://www.ti.com) <<http://www.ti.com>>. Publication IPC-7351 is recommended for alternate designs.
  - E. Laser cutting apertures with trapezoidal walls and also rounding corners will offer better paste release. Customers should contact their board assembly site for stencil design recommendations. Example stencil design based on a 50% volumetric metal load solder paste. Refer to IPC-7525 for other stencil recommendations.
  - F. Customers should contact their board fabrication site for solder mask tolerances between and around signal pads.

PowerPAD is a trademark of Texas Instruments.

RGW (S-PVQFN-N20)

PLASTIC QUAD FLATPACK NO-LEAD

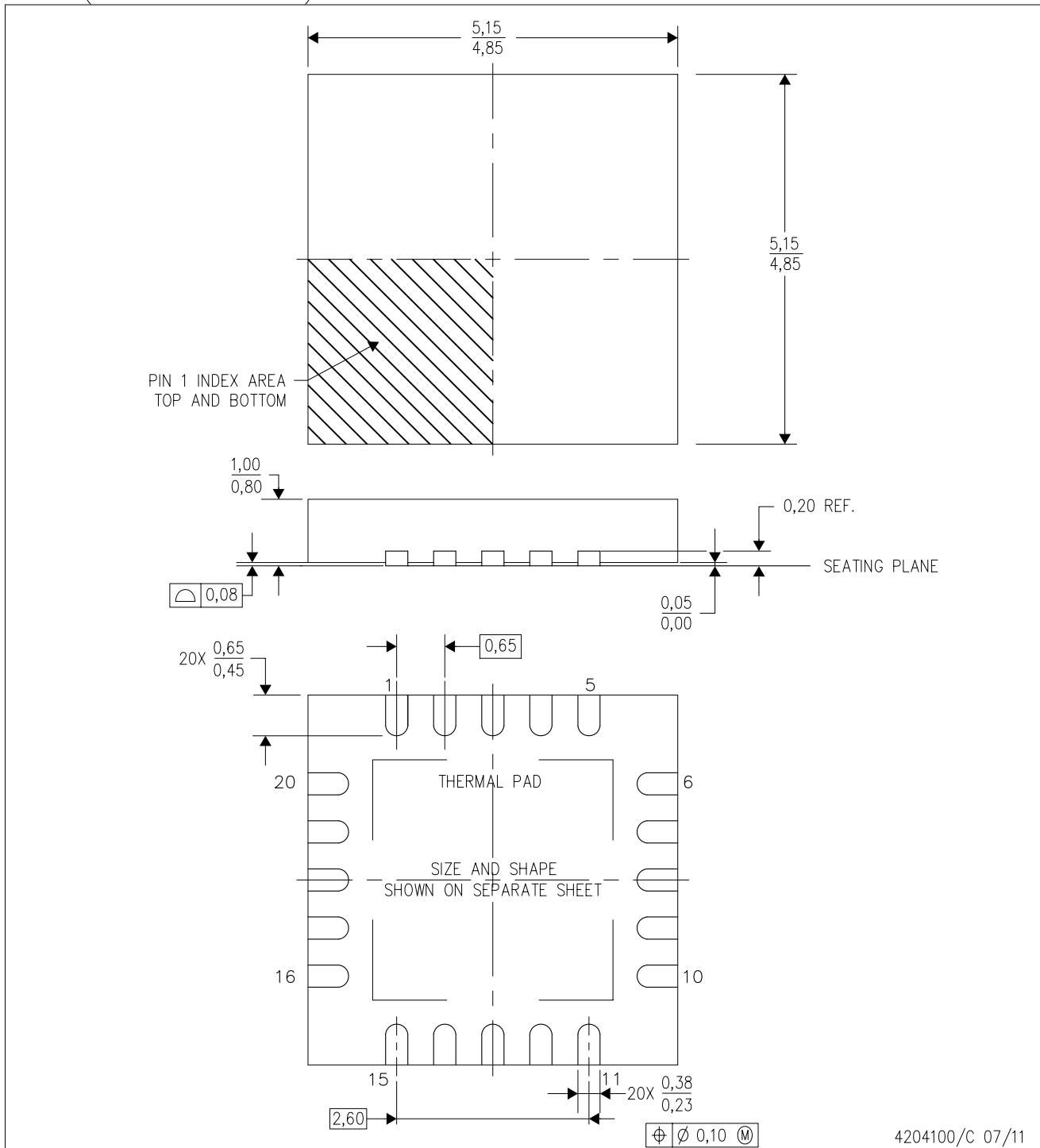

- NOTES:
- A. All linear dimensions are in millimeters. Dimensioning and tolerancing per ASME Y14.5-1994.
  - B. This drawing is subject to change without notice.
  - C. Quad Flat pack, No-leads (QFN) package configuration
  - D. The package thermal pad must be soldered to the board for thermal and mechanical performance.
  - E. See the additional figure in the Product Data Sheet for details regarding the exposed thermal pad features and dimensions.
  - F. Falls within JEDEC MO-220.

# THERMAL PAD MECHANICAL DATA

RGW (S-PVQFN-N20)

PLASTIC QUAD FLATPACK NO-LEAD

## THERMAL INFORMATION

This package incorporates an exposed thermal pad that is designed to be attached directly to an external heatsink. The thermal pad must be soldered directly to the printed circuit board (PCB). After soldering, the PCB can be used as a heatsink. In addition, through the use of thermal vias, the thermal pad can be attached directly to the appropriate copper plane shown in the electrical schematic for the device, or alternatively, can be attached to a special heatsink structure designed into the PCB. This design optimizes the heat transfer from the integrated circuit (IC).

For information on the Quad Flatpack No-Lead (QFN) package and its advantages, refer to Application Report, QFN/SON PCB Attachment, Texas Instruments Literature No. SLUA271. This document is available at [www.ti.com](http://www.ti.com).

The exposed thermal pad dimensions for this package are shown in the following illustration.

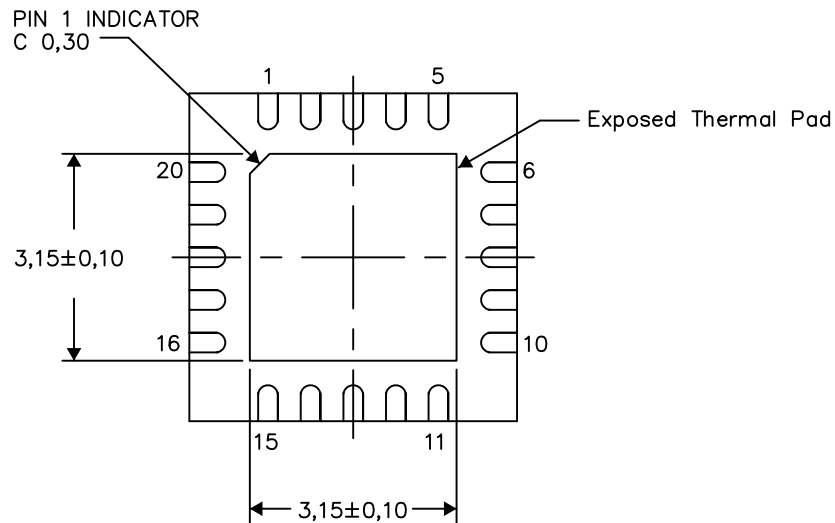

Bottom View

Exposed Thermal Pad Dimensions

4206352-2/K 12/12

NOTE: All linear dimensions are in millimeters

RGW (S-PVQFN-N20)

PLASTIC QUAD FLATPACK NO-LEAD

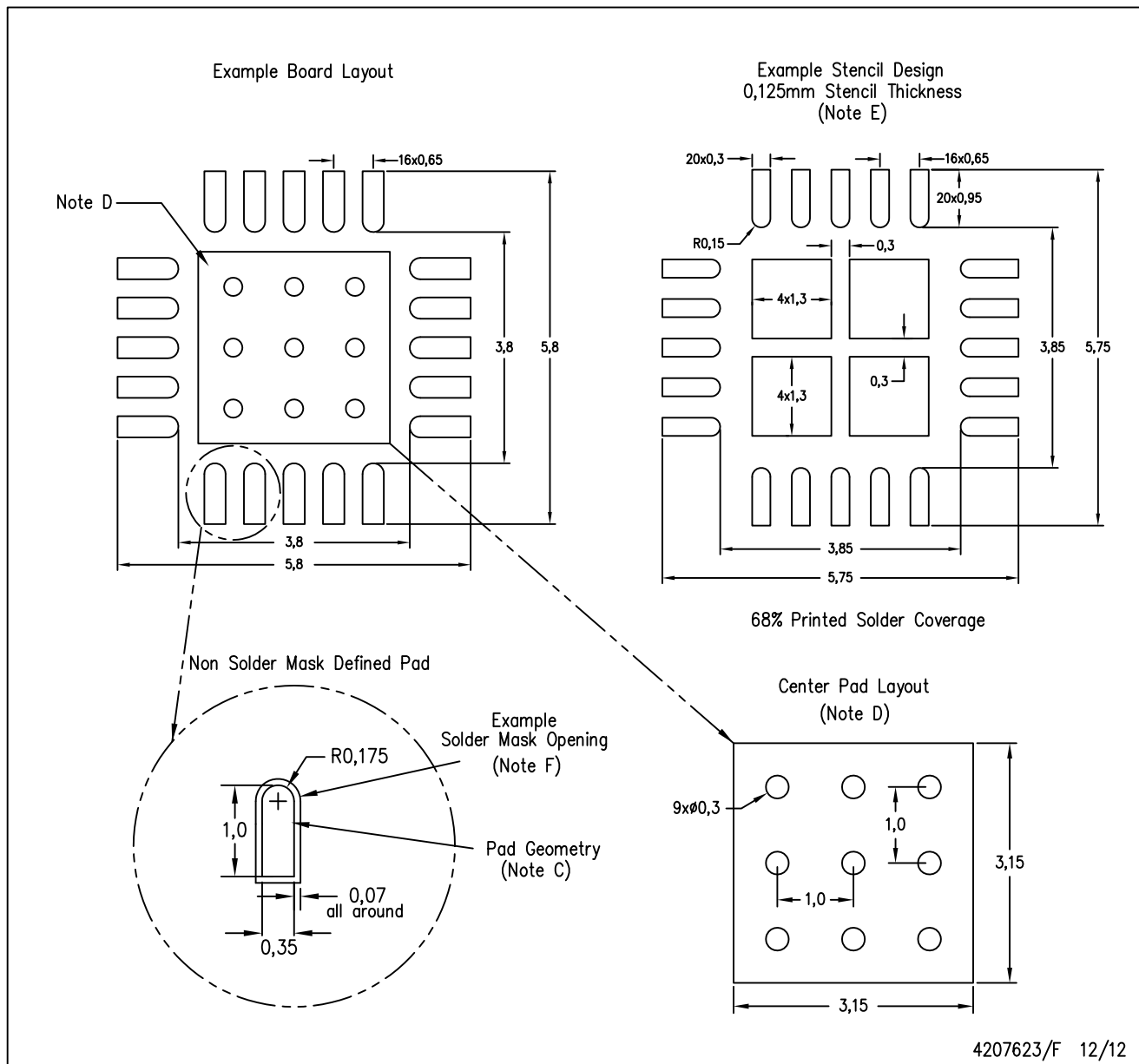

- NOTES:
- All linear dimensions are in millimeters.
  - This drawing is subject to change without notice.
  - Publication IPC-7351 is recommended for alternate designs.
  - This package is designed to be soldered to a thermal pad on the board. Refer to Application Note, QFN Packages, Texas Instruments Literature No. SLUA271, and also the Product Data Sheets for specific thermal information, via requirements, and recommended board layout. These documents are available at [www.ti.com](http://www.ti.com) <<http://www.ti.com>>.
  - Laser cutting apertures with trapezoidal walls and also rounding corners will offer better paste release. Customers should contact their board assembly site for stencil design recommendations. Refer to IPC 7525 for stencil design considerations.
  - Customers should contact their board fabrication site for solder mask tolerances.

## IMPORTANT NOTICE

Texas Instruments Incorporated and its subsidiaries (TI) reserve the right to make corrections, enhancements, improvements and other changes to its semiconductor products and services per JESD46, latest issue, and to discontinue any product or service per JESD48, latest issue. Buyers should obtain the latest relevant information before placing orders and should verify that such information is current and complete. All semiconductor products (also referred to herein as "components") are sold subject to TI's terms and conditions of sale supplied at the time of order acknowledgment.

TI warrants performance of its components to the specifications applicable at the time of sale, in accordance with the warranty in TI's terms and conditions of sale of semiconductor products. Testing and other quality control techniques are used to the extent TI deems necessary to support this warranty. Except where mandated by applicable law, testing of all parameters of each component is not necessarily performed.

TI assumes no liability for applications assistance or the design of Buyers' products. Buyers are responsible for their products and applications using TI components. To minimize the risks associated with Buyers' products and applications, Buyers should provide adequate design and operating safeguards.

TI does not warrant or represent that any license, either express or implied, is granted under any patent right, copyright, mask work right, or other intellectual property right relating to any combination, machine, or process in which TI components or services are used. Information published by TI regarding third-party products or services does not constitute a license to use such products or services or a warranty or endorsement thereof. Use of such information may require a license from a third party under the patents or other intellectual property of the third party, or a license from TI under the patents or other intellectual property of TI.

Reproduction of significant portions of TI information in TI data books or data sheets is permissible only if reproduction is without alteration and is accompanied by all associated warranties, conditions, limitations, and notices. TI is not responsible or liable for such altered documentation. Information of third parties may be subject to additional restrictions.

Resale of TI components or services with statements different from or beyond the parameters stated by TI for that component or service voids all express and any implied warranties for the associated TI component or service and is an unfair and deceptive business practice. TI is not responsible or liable for any such statements.

Buyer acknowledges and agrees that it is solely responsible for compliance with all legal, regulatory and safety-related requirements concerning its products, and any use of TI components in its applications, notwithstanding any applications-related information or support that may be provided by TI. Buyer represents and agrees that it has all the necessary expertise to create and implement safeguards which anticipate dangerous consequences of failures, monitor failures and their consequences, lessen the likelihood of failures that might cause harm and take appropriate remedial actions. Buyer will fully indemnify TI and its representatives against any damages arising out of the use of any TI components in safety-critical applications.

In some cases, TI components may be promoted specifically to facilitate safety-related applications. With such components, TI's goal is to help enable customers to design and create their own end-product solutions that meet applicable functional safety standards and requirements. Nonetheless, such components are subject to these terms.

No TI components are authorized for use in FDA Class III (or similar life-critical medical equipment) unless authorized officers of the parties have executed a special agreement specifically governing such use.

Only those TI components which TI has specifically designated as military grade or "enhanced plastic" are designed and intended for use in military/aerospace applications or environments. Buyer acknowledges and agrees that any military or aerospace use of TI components which have **not** been so designated is solely at the Buyer's risk, and that Buyer is solely responsible for compliance with all legal and regulatory requirements in connection with such use.

TI has specifically designated certain components as meeting ISO/TS16949 requirements, mainly for automotive use. In any case of use of non-designated products, TI will not be responsible for any failure to meet ISO/TS16949.

### Products

Audio	<a href="http://www.ti.com/audio">www.ti.com/audio</a>
Amplifiers	<a href="http://amplifier.ti.com">amplifier.ti.com</a>
Data Converters	<a href="http://dataconverter.ti.com">dataconverter.ti.com</a>
DLP® Products	<a href="http://www.dlp.com">www.dlp.com</a>
DSP	<a href="http://dsp.ti.com">dsp.ti.com</a>
Clocks and Timers	<a href="http://www.ti.com/clocks">www.ti.com/clocks</a>
Interface	<a href="http://interface.ti.com">interface.ti.com</a>
Logic	<a href="http://logic.ti.com">logic.ti.com</a>
Power Mgmt	<a href="http://power.ti.com">power.ti.com</a>
Microcontrollers	<a href="http://microcontroller.ti.com">microcontroller.ti.com</a>
RFID	<a href="http://www.ti-rfid.com">www.ti-rfid.com</a>
OMAP Applications Processors	<a href="http://www.ti.com/omap">www.ti.com/omap</a>
Wireless Connectivity	<a href="http://www.ti.com/wirelessconnectivity">www.ti.com/wirelessconnectivity</a>

### Applications

Automotive and Transportation	<a href="http://www.ti.com/automotive">www.ti.com/automotive</a>
Communications and Telecom	<a href="http://www.ti.com/communications">www.ti.com/communications</a>
Computers and Peripherals	<a href="http://www.ti.com/computers">www.ti.com/computers</a>
Consumer Electronics	<a href="http://www.ti.com/consumer-apps">www.ti.com/consumer-apps</a>
Energy and Lighting	<a href="http://www.ti.com/energy">www.ti.com/energy</a>
Industrial	<a href="http://www.ti.com/industrial">www.ti.com/industrial</a>
Medical	<a href="http://www.ti.com/medical">www.ti.com/medical</a>
Security	<a href="http://www.ti.com/security">www.ti.com/security</a>
Space, Avionics and Defense	<a href="http://www.ti.com/space-avionics-defense">www.ti.com/space-avionics-defense</a>
Video and Imaging	<a href="http://www.ti.com/video">www.ti.com/video</a>

### TI E2E Community

[e2e.ti.com](http://e2e.ti.com)