



STTH2003CT/CG/CF/CR/CFP

HIGH FREQUENCY SECONDARY RECTIFIER

MAJOR PRODUCT CHARACTERISTICS

$I_{F(AV)}$	2 x 10 A
V_{RRM}	300 V
$T_j(\text{max})$	175 °C
$V_F(\text{max})$	1 V
$t_{rr}(\text{max})$	35 ns

FEATURES AND BENEFITS

- COMBINES HIGHEST RECOVERY AND REVERSE VOLTAGE PERFORMANCE
- ULTRA-FAST, SOFT AND NOISE-FREE RECOVERY
- INSULATED PACKAGES: ISOWATT220AB, TO-220FPAB
Electric insulation: 2000VDC
Capacitance: 12pF

DESCRIPTION

Dual center tap Fast Recovery Epitaxial Diodes suited for Switch Mode Power Supply and high frequency DC/DC converters.

Packaged in TO-220AB, ISOWATT220AB, TO-220FPAB, I²PAK or D²PAK, this device is especially intended for secondary rectification.

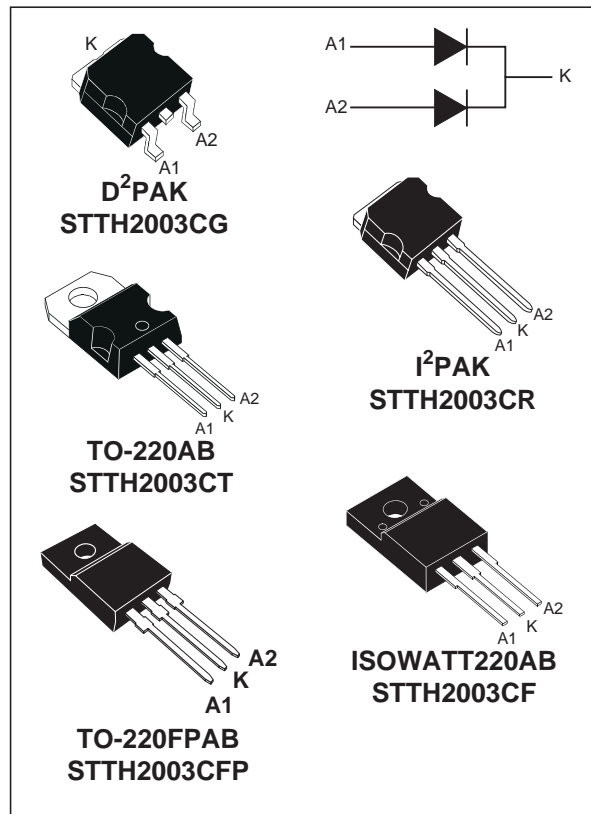

ABSOLUTE RATINGS (limiting values, per diode)

Symbol	Parameter			Value	Unit	
V_{RRM}	Repetitive peak reverse voltage			300	V	
$I_{F(RMS)}$	RMS forward current			30	A	
$I_{F(AV)}$	Average forward current $\delta = 0.5$	TO-220AB / D ² PAK / I ² PAK	$T_c = 140^\circ\text{C}$	Per diode Per device	10 20	A
		ISOWATT220AB	$T_c = 125^\circ\text{C}$			
		TO-220FPAB	$T_c = 115^\circ\text{C}$			
I_{FSM}	Surge non repetitive forward current		$t_p = 10 \text{ ms}$ sinusoidal	110	A	
I_{RSM}	Non repetitive avalanche current		$t_p = 20 \mu\text{s}$ square	5	A	
T_{stg}	Storage temperature range			-65 + 175	°C	
T_j	Maximum operating junction temperature			175	°C	

THERMAL RESISTANCES

Symbol	Parameter			Value	Unit
R _{th(j-c)}	Junction to case	TO-220AB / D ² PAK / I ² PAK	Per diode	2.5	°C/W
			Total	1.3	
		ISOWATT220AB	Per diode	3.9	
			Total	3.2	
		TO-220FPAB	Per diode	4.6	
			Total	4	
R _{th(c)}		TO-220AB / D ² PAK / I ² PAK	Coupling	0.1	
		ISOWATT220AB	Coupling	2.5	
		TO-220FPAB	Coupling	3.5	

STATIC ELECTRICAL CHARACTERISTICS (per diode)

Symbol	Parameter	Tests conditions		Min.	Typ.	Max.	Unit
I _R *	Reverse leakage current	V _R = 300 V	T _j = 25°C			20	μA
			T _j = 125°C		30	300	
V _F **	Forward voltage drop	I _F = 10 A	T _j = 25°C			1.25	V
			T _j = 125°C		0.85	1	

Pulse test : * tp = 5 ms, δ < 2 %

** tp = 380 μs, δ < 2%

To evaluate the maximum conduction losses use the following equation :

$$P = 0.75 \times I_{F(AV)} + 0.025 I_{F(RMS)}^2$$

RECOVERY CHARACTERISTICS

Symbol	Tests conditions			Min.	Typ.	Max.	Unit
trr	I _F = 0.5 A	I _{rr} = 0.25 A	I _R = 1 A	T _j = 25°C		25	ns
	I _F = 1 A	dI _F /dt = - 50 A/μs	V _R = 30 V			35	
tfr	I _F = 10 A	dI _F /dt = 100 A/μs		T _j = 25°C		230	ns
V _{FP}	V _{FR} = 1.1 x V _F max.					3.5	V
S _{factor}	V _{CC} = 200V	I _F = 10 A		T _j = 125°C	0.3		-
I _{RM}	dI _F /dt = 200 A/μs					8	A

Fig. 1: Conduction losses versus average current (per diode).

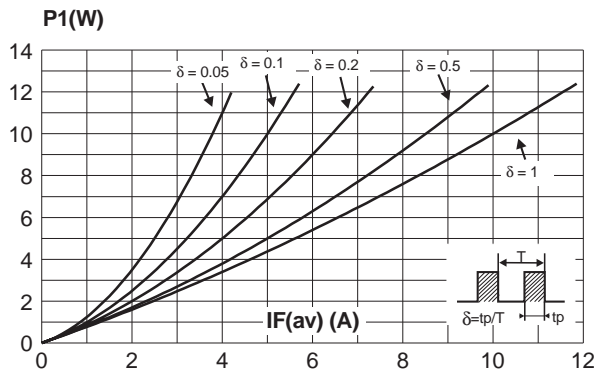

Fig. 2: Forward voltage drop versus forward current (maximum values, per diode).

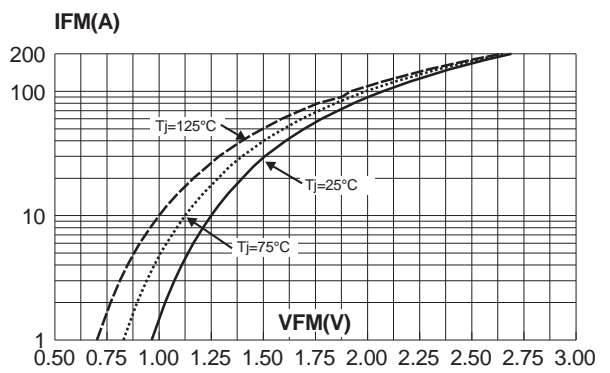

Fig. 3-1: Relative variation of thermal impedance junction to case versus pulse duration (TO-220AB / D²PAK / I²PAK).

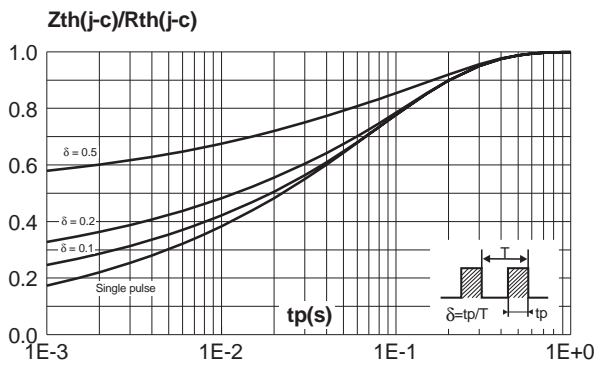

Fig. 3-2: Relative variation of thermal impedance junction to case versus pulse duration (ISOWATT220AB).

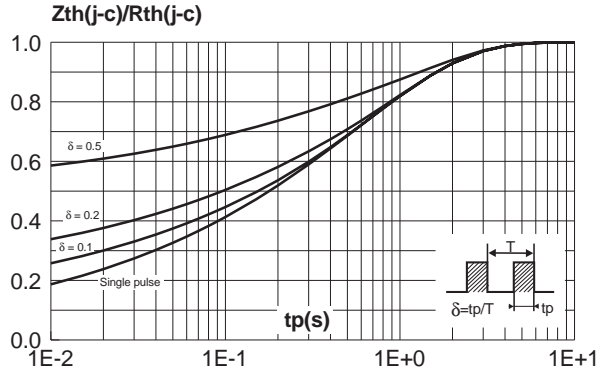

Fig. 4: Peak reverse recovery current versus di_F/dt (90% confidence, per diode).

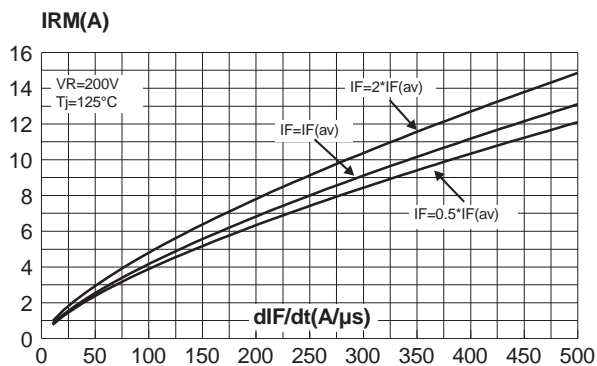

Fig. 5: Reverse recovery time versus di_F/dt (90% confidence, per diode).

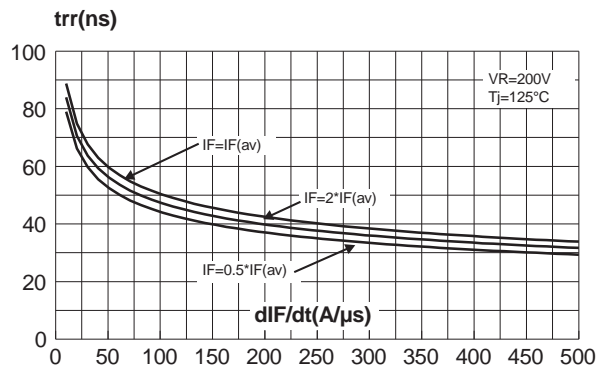

Fig. 6: Softness factor (t_b/t_a) versus dI_F/dt (typical values, per diode).

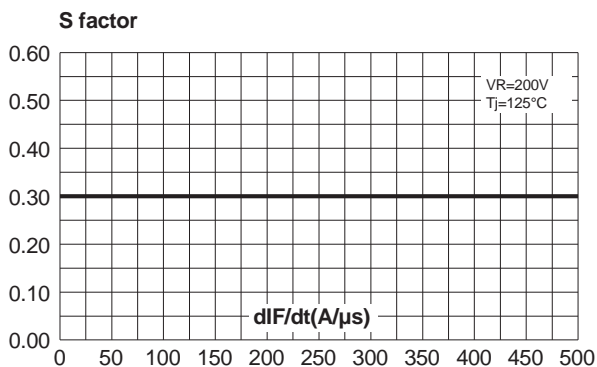

Fig. 7: Relative variation of dynamic parameters versus junction temperature (reference: $T_j = 125^\circ\text{C}$).

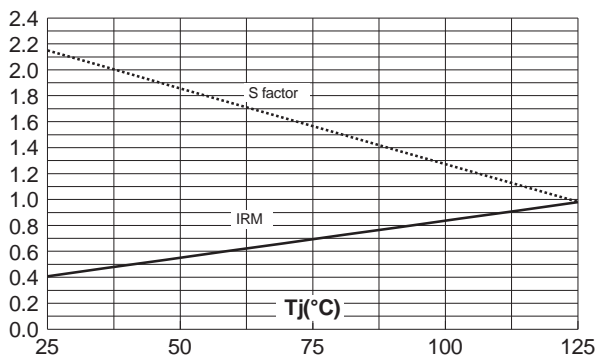

Fig. 8: Transient peak forward voltage versus dI_F/dt (90% confidence, per diode) (TO-220AB).

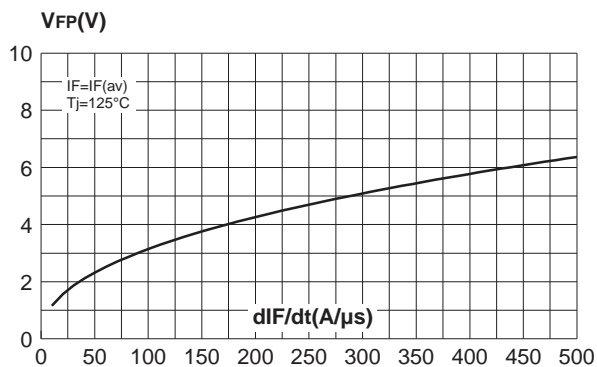

Fig. 9: Forward recovery time versus dI_F/dt (90% confidence, per diode).

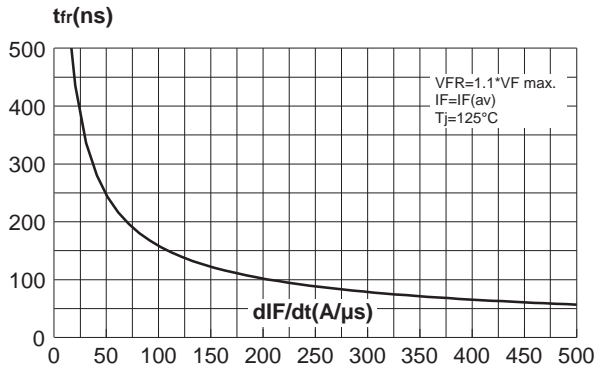
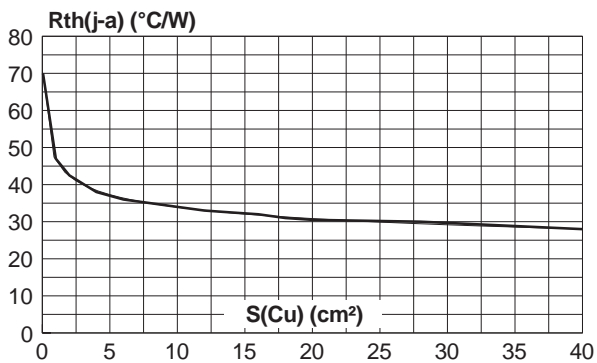
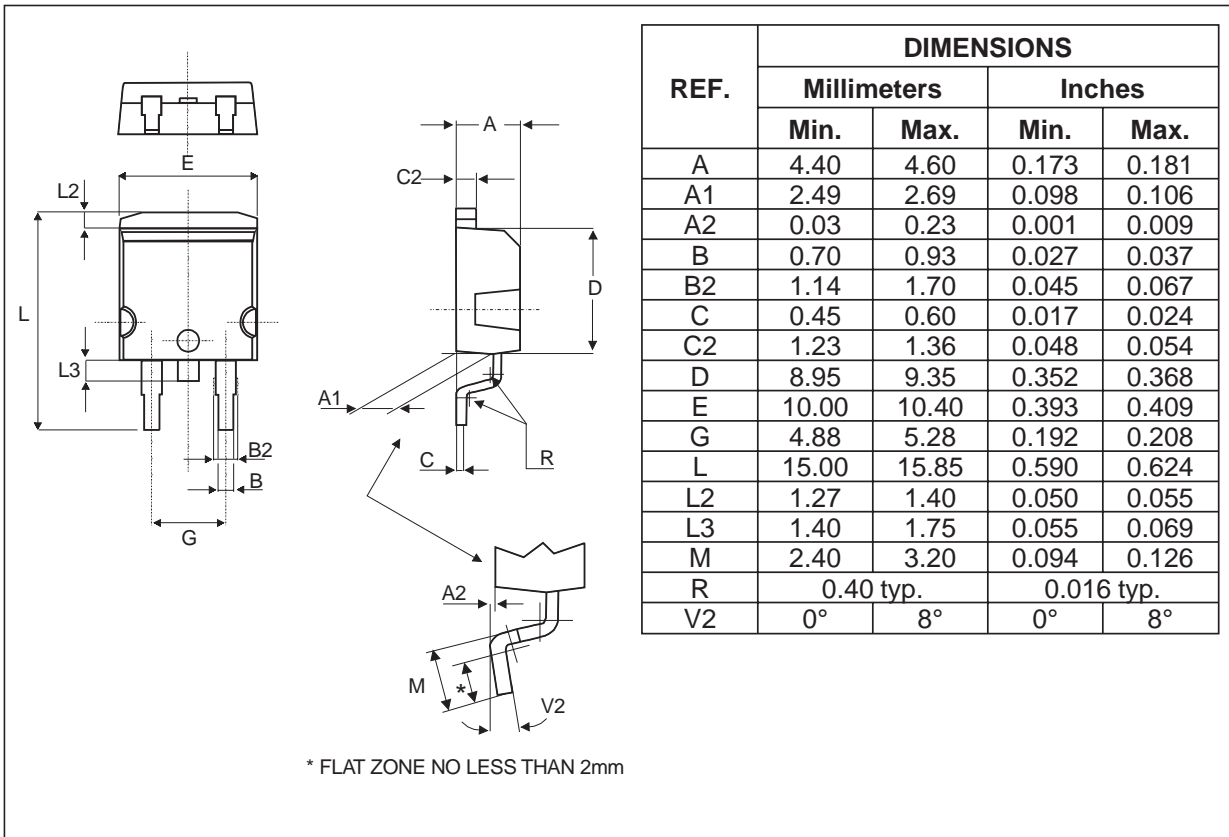

Fig. 10: Thermal resistance junction to ambient versus copper surface under tab (Epoxy printed circuit board FR4, copper thickness: $35\mu\text{m}$) ($D^2\text{PAK}$).



PACKAGE MECHANICAL DATA
D²PAK



FOOT PRINT DIMENSIONS (in millimeters)
D²PAK

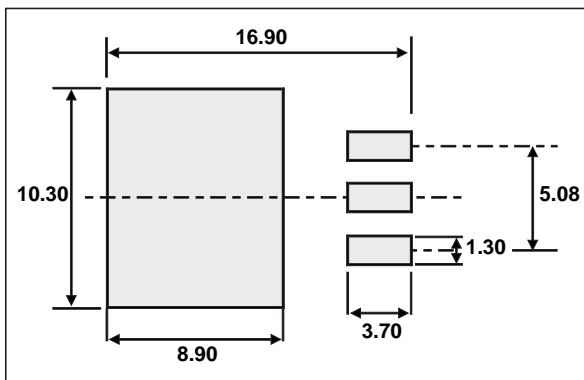

PACKAGE MECHANICAL DATA
ISOWATT220AB

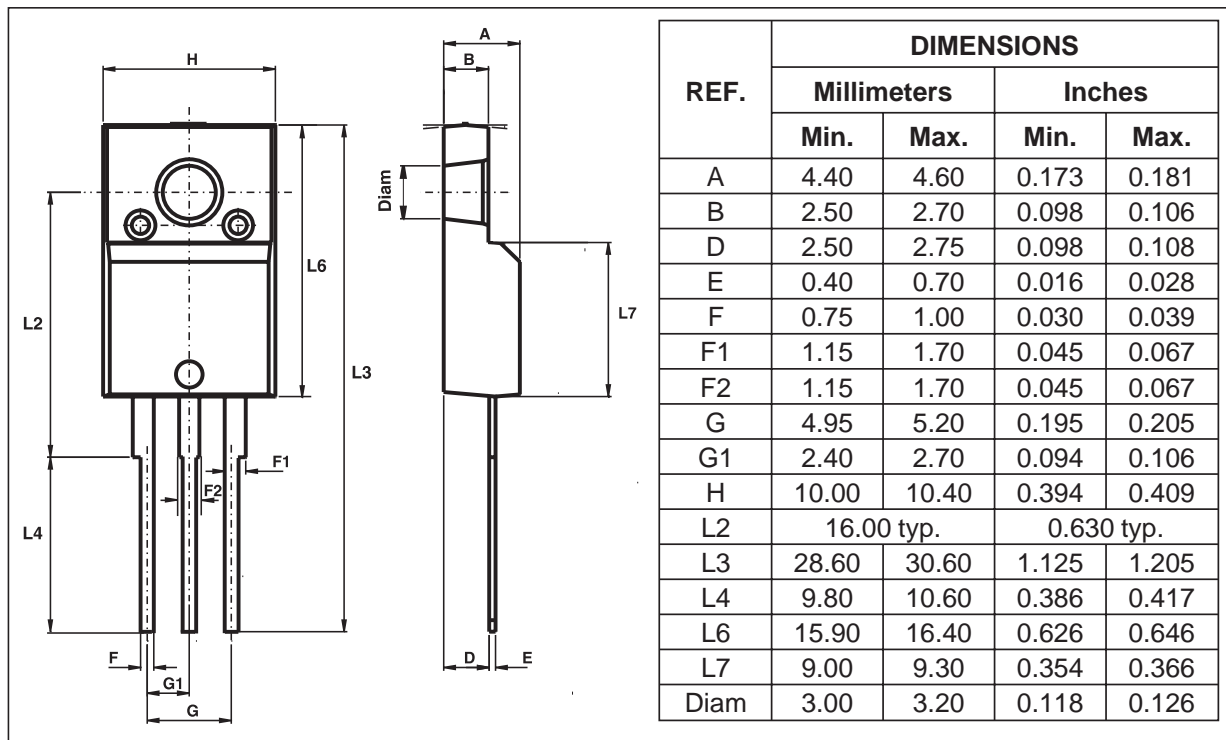

PACKAGE MECHANICAL DATA
TO-220AB

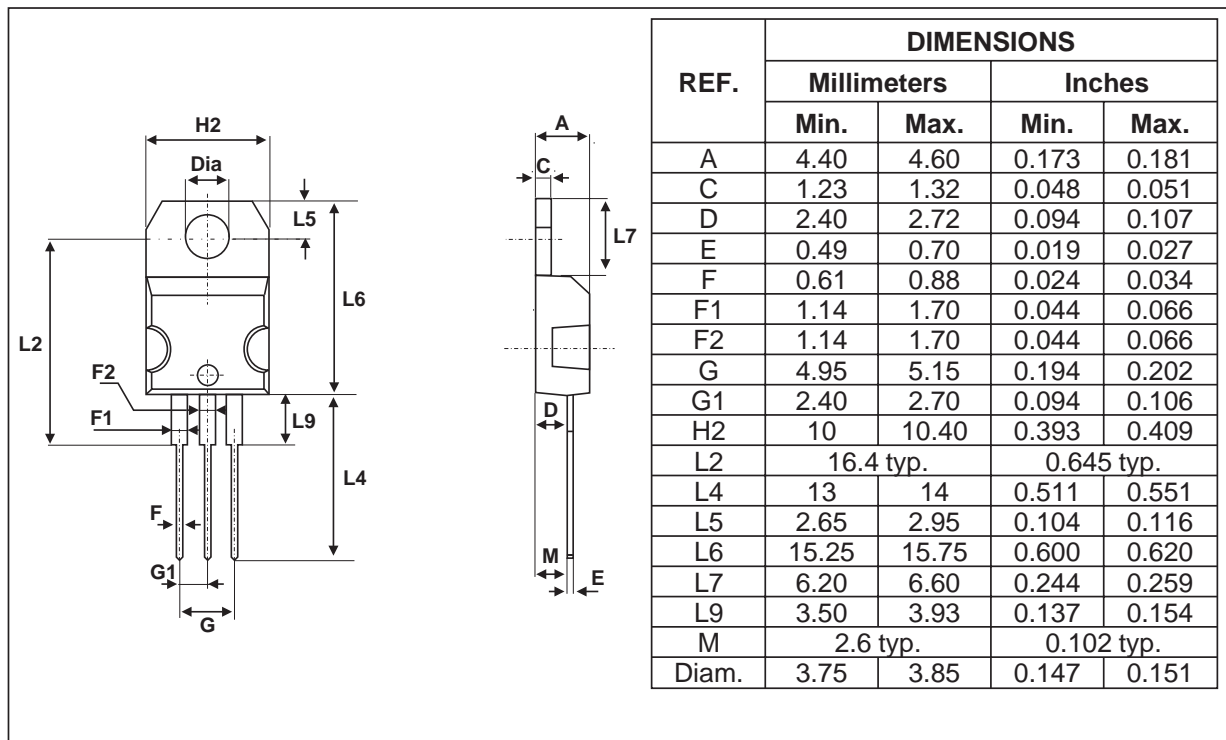

PACKAGE MECHANICAL DATA
TO-220FPAB

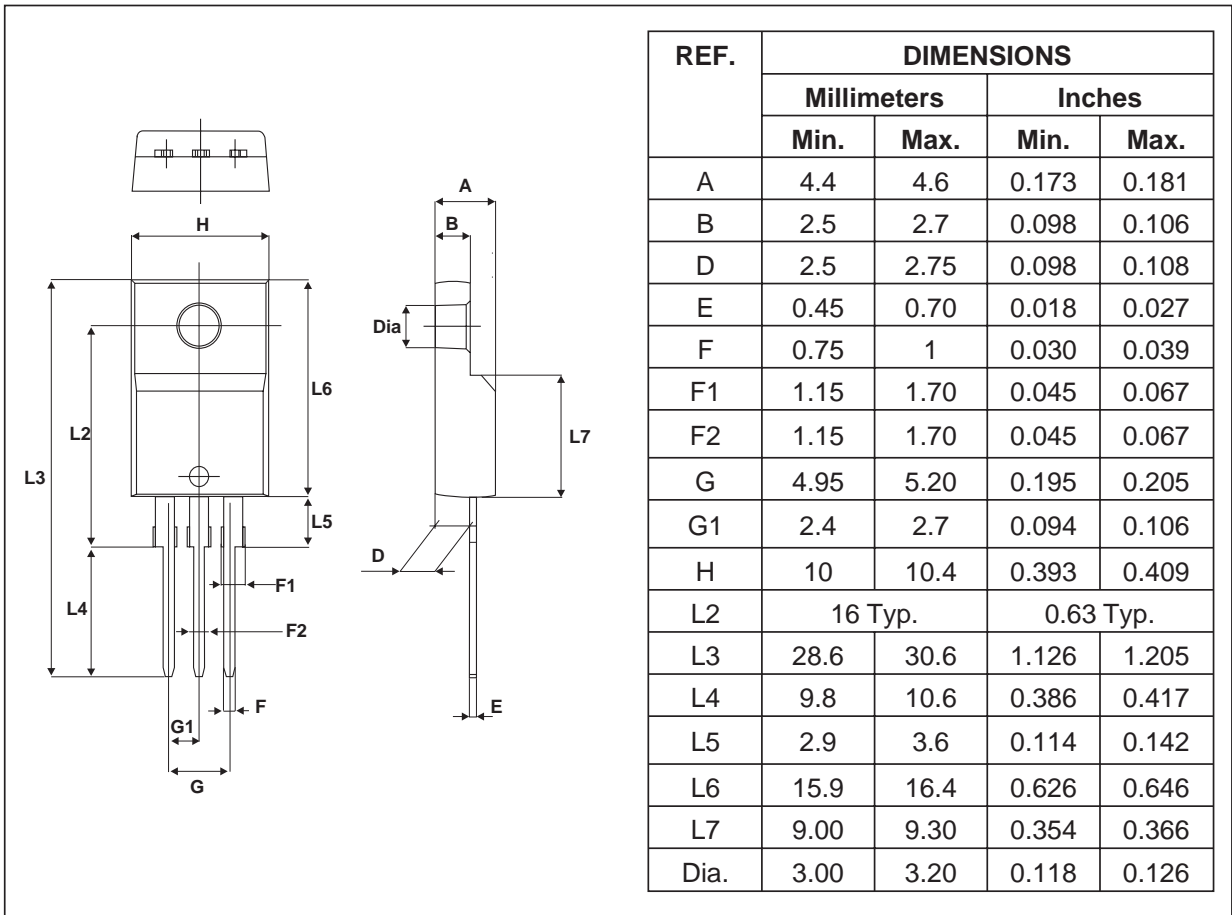

STTH2003CT/CG/CF/CR/CFP

PACKAGE MECHANICAL DATA
I²PAK

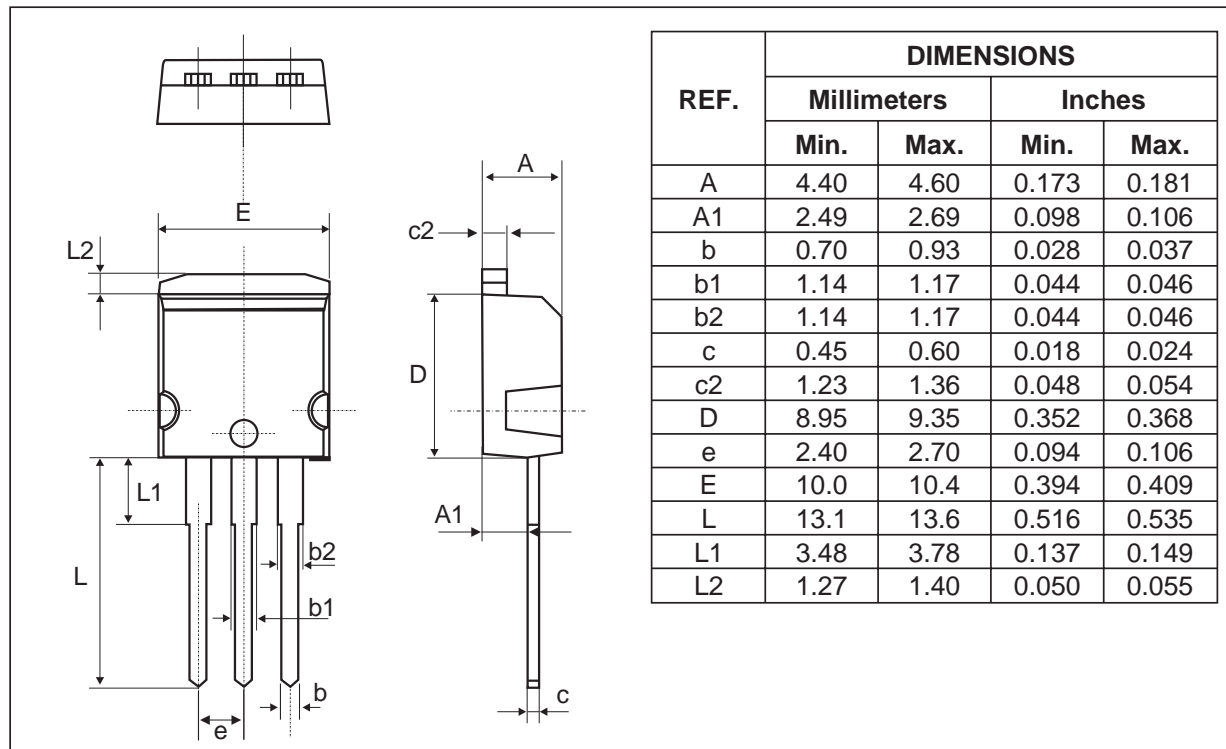

Ordering code	Marking	Package	Weight	Base qty	Delivery mode
STTH2003CT	STTH2003CT	TO-220AB	2.2 g	50	Tube
STTH2003CG	STTH2003CG	D ² PAK	1.48 g	50	Tube
STTH2003CG-TR	STTH2003CG	D2PAK	1.48 g	500	Tape & reel
STTH2003CF	STTH2003CF	ISOWATT220AB	2.08 g	50	Tube
STTH2003CFP	STTH2003CFP	TO-220FPAB	2.08 g	50	Tube
STTH2003CR	STTH2003CR	I ² PAK	1.49 g	50	Tube

- Cooling method: by conduction (C)
- Recommended torque value: 0.55 N.m.
- Maximum torque value: 0.70 N.m.
- Epoxy meets UL 94,V0

Information furnished is believed to be accurate and reliable. However, STMicroelectronics assumes no responsibility for the consequences of use of such information nor for any infringement of patents or other rights of third parties which may result from its use. No license is granted by implication or otherwise under any patent or patent rights of STMicroelectronics. Specifications mentioned in this publication are subject to change without notice. This publication supersedes and replaces all information previously supplied. STMicroelectronics products are not authorized for use as critical components in life support devices or systems without express written approval of STMicroelectronics.

The ST logo is a registered trademark of STMicroelectronics.

All other names are the property of their respective owners.

© 2003 STMicroelectronics - All rights reserved.

STMicroelectronics GROUP OF COMPANIES

Australia - Belgium - Brazil - Canada - China - Czech Republic - Finland - France - Germany - Hong Kong - India - Israel - Italy - Japan - Malaysia - Malta - Morocco - Singapore - Spain - Sweden - Switzerland - United Kingdom - United States

www.st.com

