

# SN75ALS197 QUADRUPLE DIFFERENTIAL LINE RECEIVER

SLLS045B – JANUARY 1989 – REVISED MAY 1995

- Meets or Exceeds the Requirements of ITU Recommendations V.10, V.11, X.26, and X.27
- Designed for Multipoint Bus Transmission on Long Bus Lines in Noisy Environments
- Designed to Operate Up to 20 Mbaud
- 3-State Outputs
- Common-Mode Input Voltage Range – 7 V to 7 V
- Input Sensitivity . . .  $\pm 300$  mV
- Input Hysteresis . . . 120 mV Typ
- High-Input Impedance . . . 12 k $\Omega$  Min
- Operates from Single 5-V Supply
- Low Supply-Current Requirement 35 mA Max
- Improved Speed and Power Consumption Compared to AM26LS32A

D OR N PACKAGE  
(TOP VIEW)

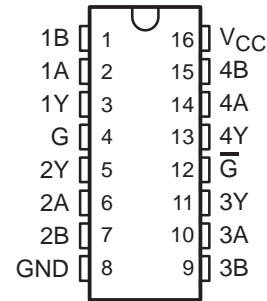

## description

The SN75ALS197 is a monolithic, quadruple line receiver with 3-state outputs designed using advanced, low-power, Schottky technology. This technology provides combined improvements in bar design, tooling production, and wafer fabrication. This, in turn, provides significantly lower power requirements and permits much higher data throughput than other designs. The device meets the specifications of ITU Recommendations V.10, V.11, X.26, and X.27. It features 3-state outputs that permit direct connection to a bus-organized system with a fail-safe design that ensures the outputs will always be high if the inputs are open.

The device is optimized for balanced, multipoint bus transmission at rates up to 20 megabits per second. The input features high-input impedance, input hysteresis for increased noise immunity, and an input sensitivity of  $\pm 300$  mV over a common-mode input voltage range of –7 V to 7 V. It also features active-high and active-low enable functions that are common to the four channels. The SN75ALS197 is designed for optimum performance when used with the SN75ALS192 quadruple differential line driver.

The SN75ALS197 is characterized for operation from 0°C to 70°C.

FUNCTION TABLE  
(each receiver)

DIFFERENTIAL INPUTS A–B	ENABLES		OUTPUT Y
	G	$\bar{G}$	
$V_{ID} \geq 0.3$ V	H	X	H
	X	L	H
$-0.3$ V < $V_{ID} < 0.3$ V	H	X	?
	X	L	?
$V_{ID} \leq -0.3$ V	H	X	L
	X	L	L
X	L	H	Z
Open	H	X	H
	X	L	H

H = high level, L = low level, X = irrelevant, ? = indeterminate, Z = high impedance (off)



Please be aware that an important notice concerning availability, standard warranty, and use in critical applications of Texas Instruments semiconductor products and disclaimers thereto appears at the end of this data sheet.

PRODUCTION DATA information is current as of publication date. Products conform to specifications per the terms of Texas Instruments standard warranty. Production processing does not necessarily include testing of all parameters.

 **TEXAS  
INSTRUMENTS**

POST OFFICE BOX 655303 • DALLAS, TEXAS 75265

Copyright © 1995, Texas Instruments Incorporated

# SN75ALS197 QUADRUPLE DIFFERENTIAL LINE RECEIVER

SLLS045B – JANUARY 1989 – REVISED MAY 1995

## logic symbol†

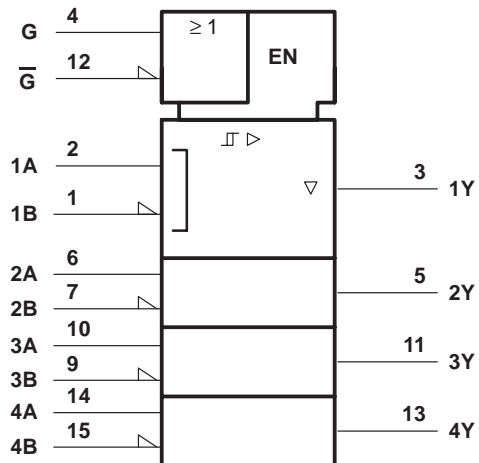

## logic diagram (positive logic)

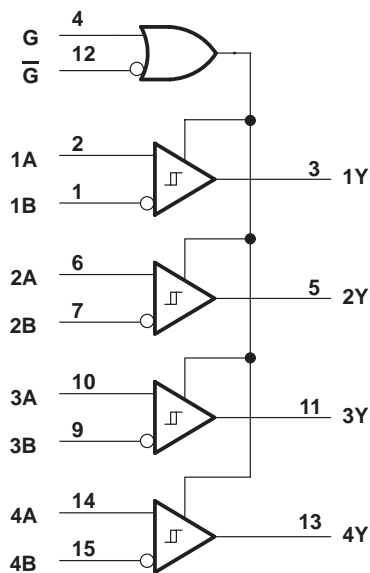

† This symbol is in accordance with ANSI/IEEE Std 91-1984 and IEC Publication 617-12.

## schematics of inputs and outputs

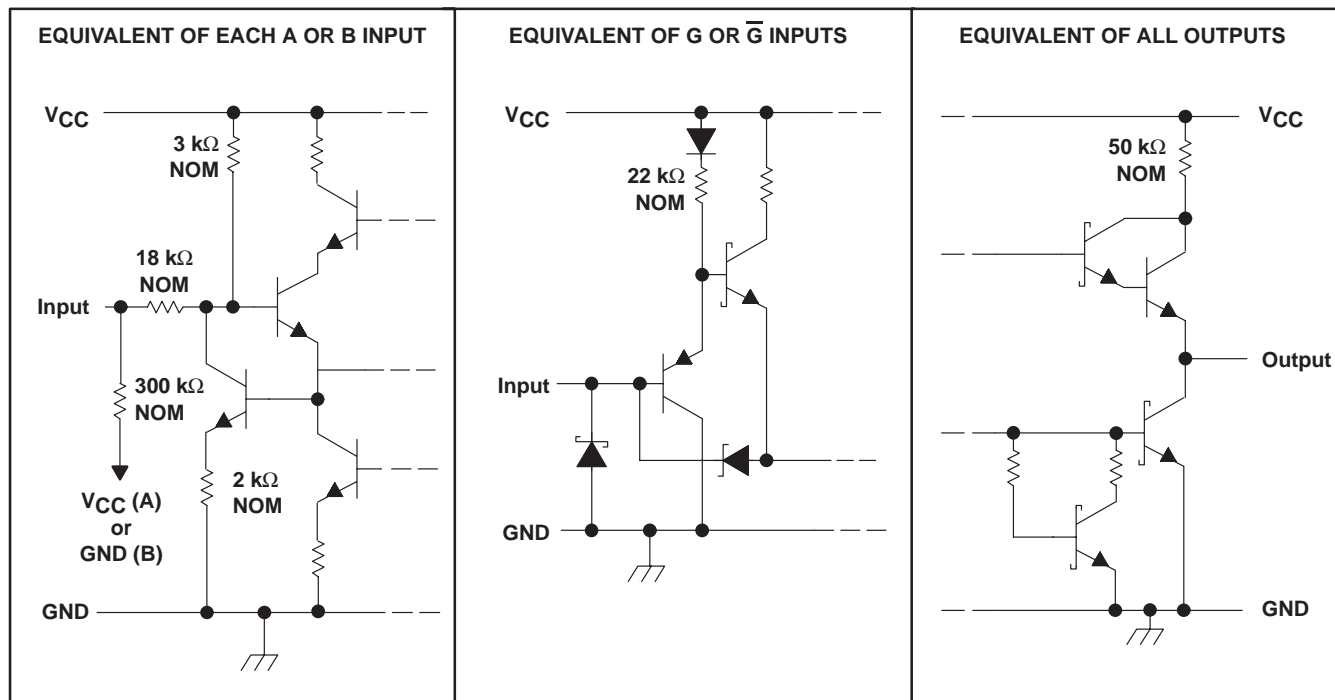

# SN75ALS197 QUADRUPLE DIFFERENTIAL LINE RECEIVER

SLLS045B – JANUARY 1989 – REVISED MAY 1995

## absolute maximum ratings over operating free-air temperature range (unless otherwise noted)†

Supply voltage, $V_{CC}$ (see Note 1)	7 V
Input voltage, $V_I$ (A or B inputs)	$\pm 15$ V
Differential input voltage, $V_{ID}$ (see Note 2)	$\pm 15$ V
Enable input voltage, $V_I$	7 V
Low-level output current, $I_{OL}$	50 mA
Continuous total dissipation	See Dissipation Rating Table
Operating free-air temperature range, $T_A$	$0^\circ\text{C}$ to $70^\circ\text{C}$
Storage temperature range, $T_{stg}$	$-65^\circ\text{C}$ to $150^\circ\text{C}$
Lead temperature 1,6 mm (1/16 inch) from case for 10 seconds	$260^\circ\text{C}$

† Stresses beyond those listed under “absolute maximum ratings” may cause permanent damage to the device. These are stress ratings only, and functional operation of the device at these or any other conditions beyond those indicated under “recommended operating conditions” is not implied. Exposure to absolute-maximum-rated conditions for extended periods may affect device reliability.

- NOTES: 1. All voltage values, except differential input voltage, are with respect to network ground terminal.  
 2. Differential input voltage is measured at the noninverting input with respect to the corresponding inverting input.

**DISSIPATION RATING TABLE**

PACKAGE	$T_A \leq 25^\circ\text{C}$ POWER RATING	DERATING FACTOR	$T_A = 70^\circ\text{C}$ POWER RATING
D	950 mW	7.6 mW/ $^\circ\text{C}$	608 mW
N	1150 mW	9.2 mW/ $^\circ\text{C}$	736 mW

## recommended operating conditions

	MIN	NOM	MAX	UNIT
Supply voltage, $V_{CC}$	4.75	5	5.25	V
Common-mode input voltage, $V_{IC}$			$\pm 7$	V
Differential input voltage, $V_{ID}$			$\pm 12$	V
High-level input voltage, $V_{IH}$	2			V
Low-level input voltage, $V_{IL}$			0.8	V
High-level output current, $I_{OH}$			-400	$\mu\text{A}$
Low-level output current, $I_{OL}$			16	mA
Operating free-air temperature, $T_A$	0		70	$^\circ\text{C}$

# SN75ALS197

## QUADRUPLE DIFFERENTIAL LINE RECEIVER

SLLS045B – JANUARY 1989 – REVISED MAY 1995

**electrical characteristics over recommended range of common-mode input voltage, supply voltage, and operating free-air temperature (unless otherwise noted)**

PARAMETER		TEST CONDITIONS	MIN	TYP†	MAX	UNIT
V <sub>IT+</sub>	Positive-going input threshold voltage				300	mV
V <sub>IT-</sub>	Negative-going input threshold voltage		-300‡			mV
V <sub>hys</sub>	Hysteresis voltage (V <sub>IT+</sub> - V <sub>IT-</sub> )	See Figure 4		120		mV
V <sub>IK</sub>	Enable-input clamp voltage	I <sub>I</sub> = -18 mA			-1.5	V
V <sub>OH</sub>	High-level output voltage	V <sub>ID</sub> = 300 mV, I <sub>OH</sub> = -400 μA	2.7	3.6		V
V <sub>OL</sub>	Low-level output voltage	V <sub>ID</sub> = -300 mV			0.45	V
			I <sub>OL</sub> = 8 mA		0.5	
I <sub>OZ</sub>	High-impedance-state output current	V <sub>CC</sub> = 5.25 V	V <sub>O</sub> = 2.4 V		20	μA
			V <sub>OH</sub> = 0.4 V		-20	
I <sub>I</sub>	Line input current	Other input at 0 V, See Note 3	V <sub>I</sub> = 15 V		0.7	mA
			V <sub>I</sub> = -15 V		-1.0	
I <sub>H</sub>	High-level enable-input current			20	μA	
		V <sub>IH</sub> = 5.25 V		100		
I <sub>IL</sub>	Low-level enable-input current	V <sub>IL</sub> = 0.4 V			-100	μA
Input resistance			12	18		kΩ
I <sub>OS</sub>	Short-circuit output current§	V <sub>ID</sub> = 3 V, V <sub>O</sub> = 0	-15	-78	-130	mA
I <sub>CC</sub>	Supply current	Outputs disabled		22	35	mA

† All typical values are at V<sub>CC</sub> = 5 V, T<sub>A</sub> = 25°C.

‡ The algebraic convention, in which the less positive limit is designated minimum, is used in this data sheet for threshold voltage levels only.

§ Not more than one output should be shorted at a time, and the duration of the short circuit should not exceed one second.

NOTE 3: Refer to ANSI Standard EIA/TIA-422-B and EIA/TIA-423-B for exact conditions.

### switching characteristics, V<sub>CC</sub> = 5 V, T<sub>A</sub> = 25°C

PARAMETER		TEST CONDITIONS	MIN	TYP	MAX	UNIT
t <sub>PLH</sub>	Propagation delay time, low- to high-level output	V <sub>ID</sub> = -2.5 V to 2.5 V, C <sub>L</sub> = 15 pF,		15	22	ns
t <sub>PHL</sub>	Propagation delay time, high- to low-level output	See Figure 2		15	22	
t <sub>PZH</sub>	Output enable time to high level	C <sub>L</sub> = 15 pF, See Figure 3			13	ns
t <sub>PZL</sub>	Output enable time to low level				11	
t <sub>PHZ</sub>	Output disable time from high level	C <sub>L</sub> = 15 pF, See Figure 3			13	ns
t <sub>PLZ</sub>	Output disable time from low level				15	



PARAMETER MEASUREMENT INFORMATION

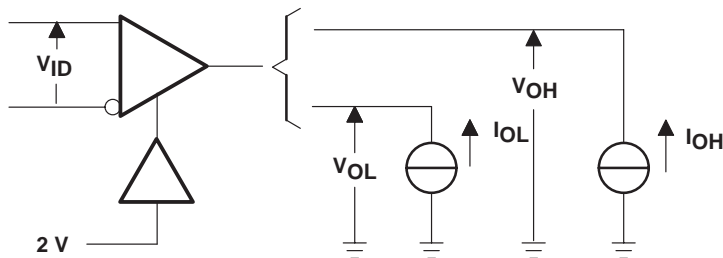
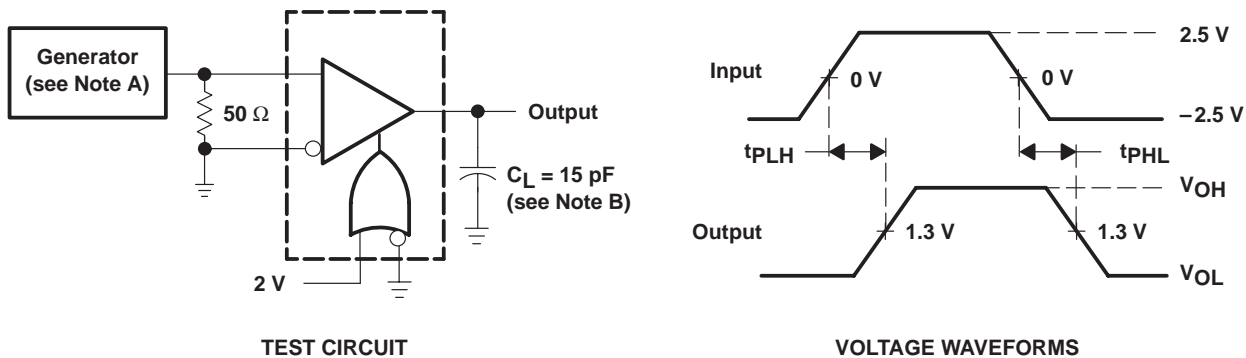

Figure 1.  $V_{OH}$  and  $V_{OL}$  Test Circuit



- NOTES: A. The input pulse is supplied by a generator having the following characteristics:  $PRR \leq 1$  MHz, duty cycle  $\leq 50\%$ ,  $Z_O = 50 \Omega$ ,  $t_r \leq 6$  ns,  $t_f \leq 6$  ns.  
 B.  $C_L$  includes probe and jig capacitance.

Figure 2.  $t_{PLH}$  and  $t_{PHL}$  Test Circuit and Voltage Waveforms

# SN75ALS197 QUADRUPLE DIFFERENTIAL LINE RECEIVER

SLLS045B – JANUARY 1989 – REVISED MAY 1995

## PARAMETER MEASUREMENT INFORMATION

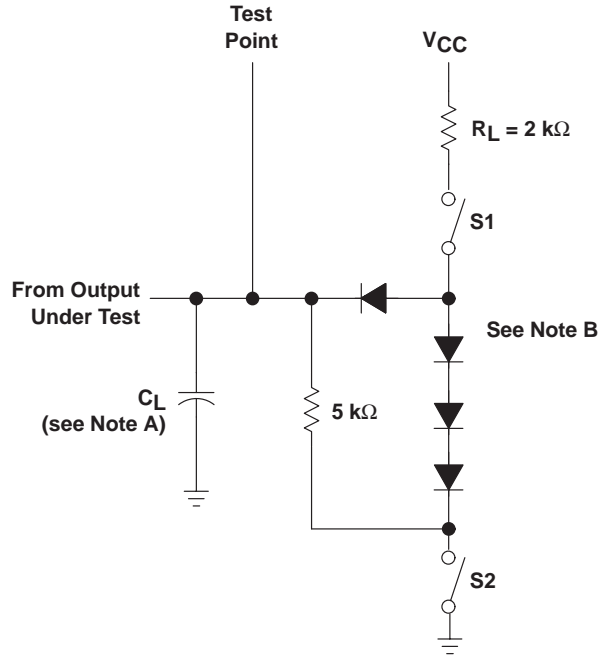

LOAD CIRCUIT

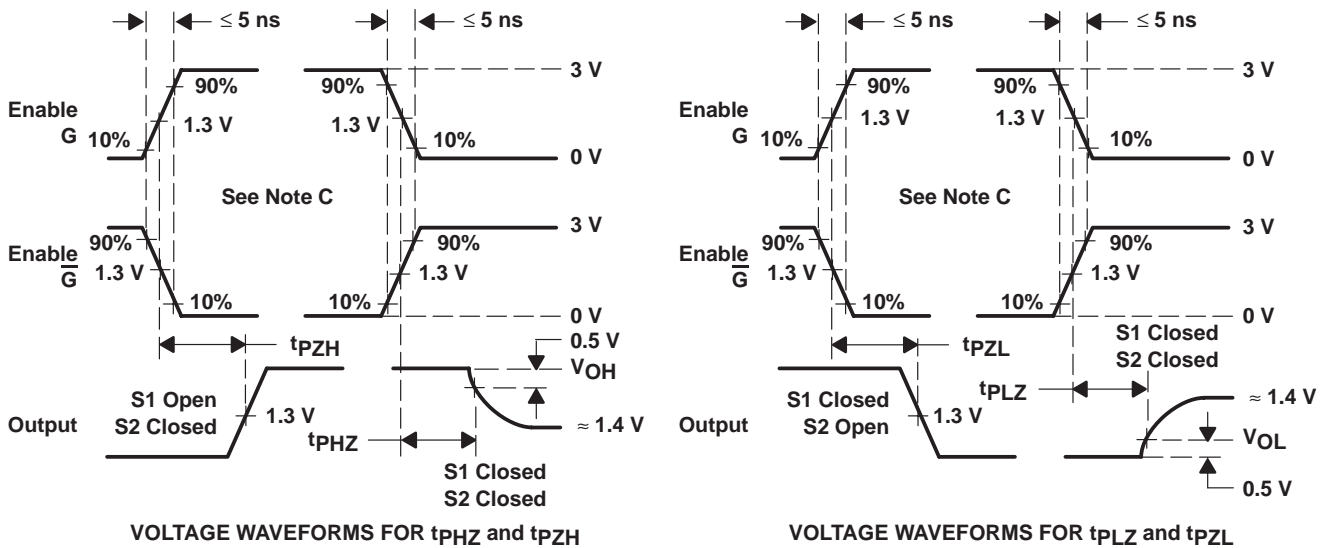

VOLTAGE WAVEFORMS FOR  $t_{PHZ}$  and  $t_{PZH}$

VOLTAGE WAVEFORMS FOR  $t_{PLZ}$  and  $t_{PZL}$

- NOTES: A.  $C_L$  includes probe and jig capacitance.  
 B. All diodes are 1N3064 or equivalent.  
 C. Enable G is tested with G high;  $\bar{G}$  is tested with G low.

Figure 3.  $t_{PHZ}$ ,  $t_{PZH}$ ,  $t_{PLZ}$ , and  $t_{PZL}$  Load Circuit and Voltage Waveforms

TYPICAL CHARACTERISTICS

OUTPUT VOLTAGE  
 vs  
 ENABLE VOLTAGE

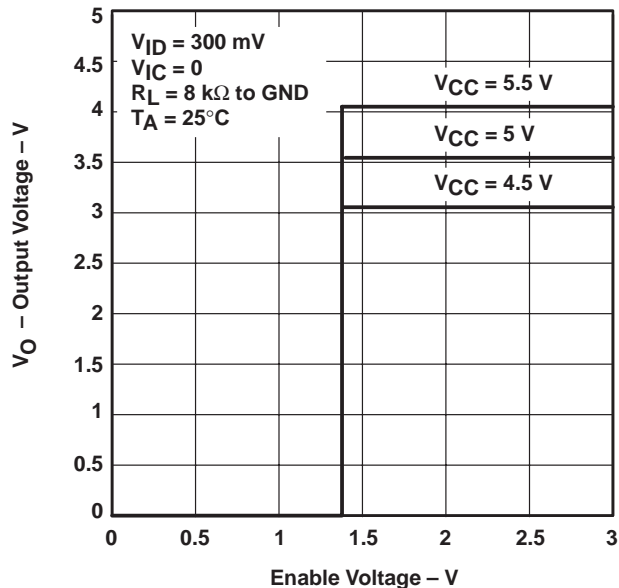

Figure 4

OUTPUT VOLTAGE  
 vs  
 ENABLE VOLTAGE

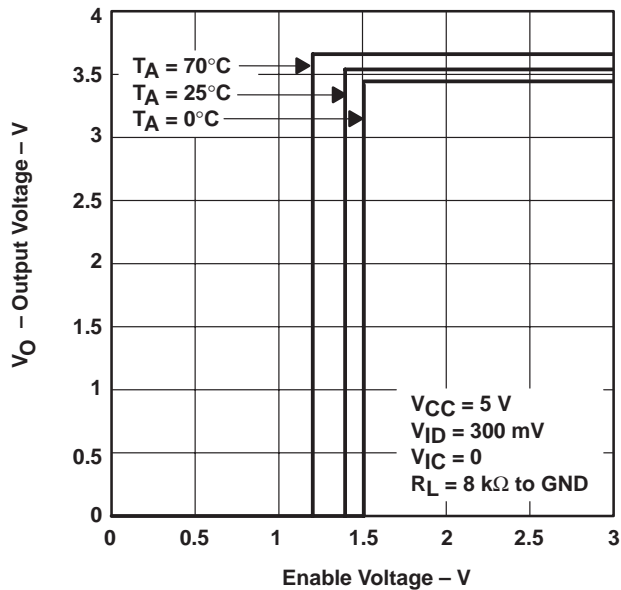

Figure 5

OUTPUT VOLTAGE  
 vs  
 ENABLE VOLTAGE

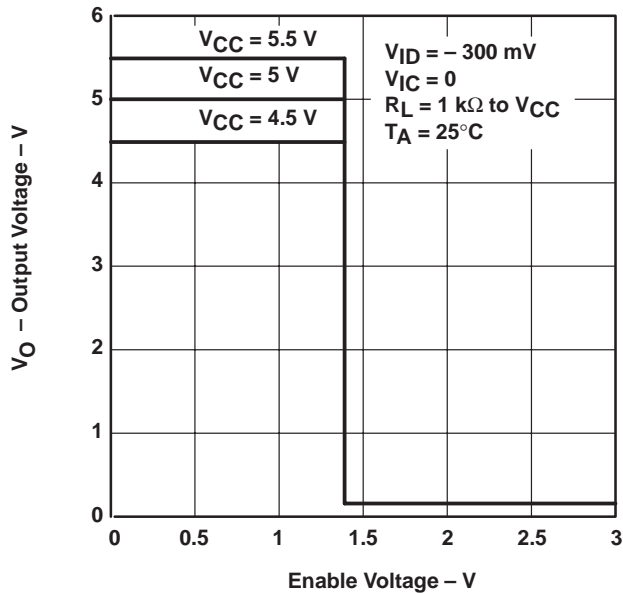

Figure 6

OUTPUT VOLTAGE  
 vs  
 ENABLE VOLTAGE

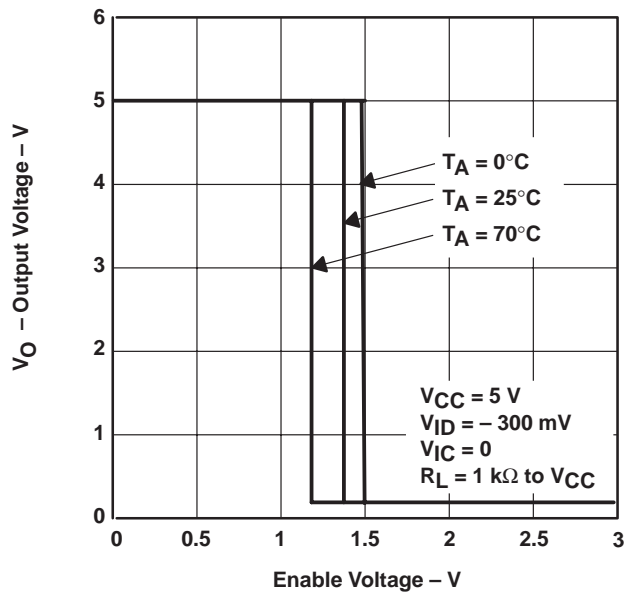
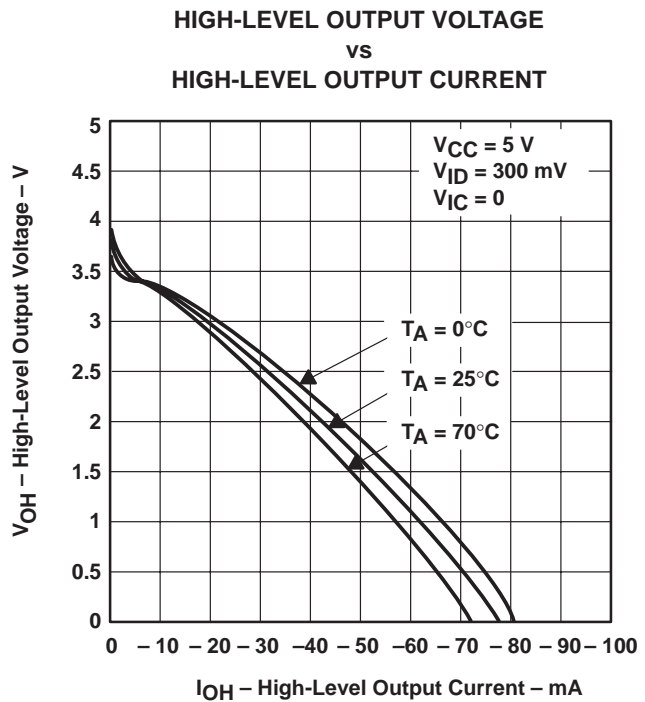
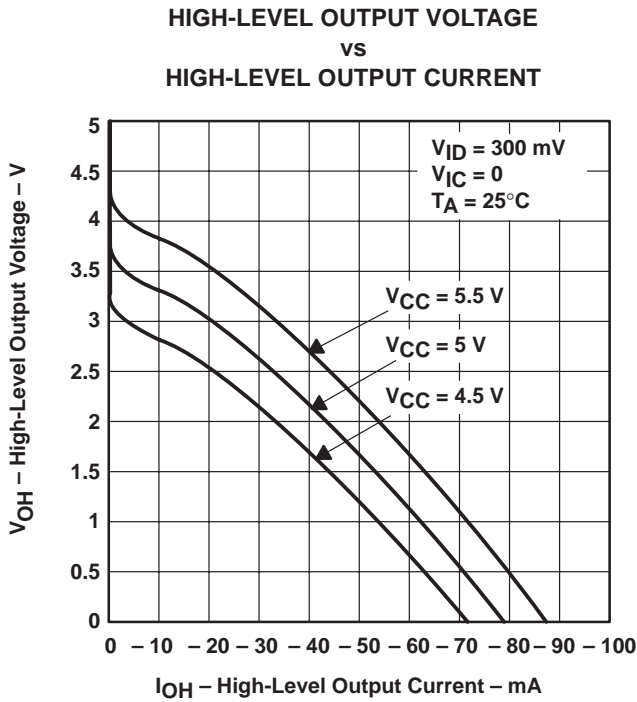
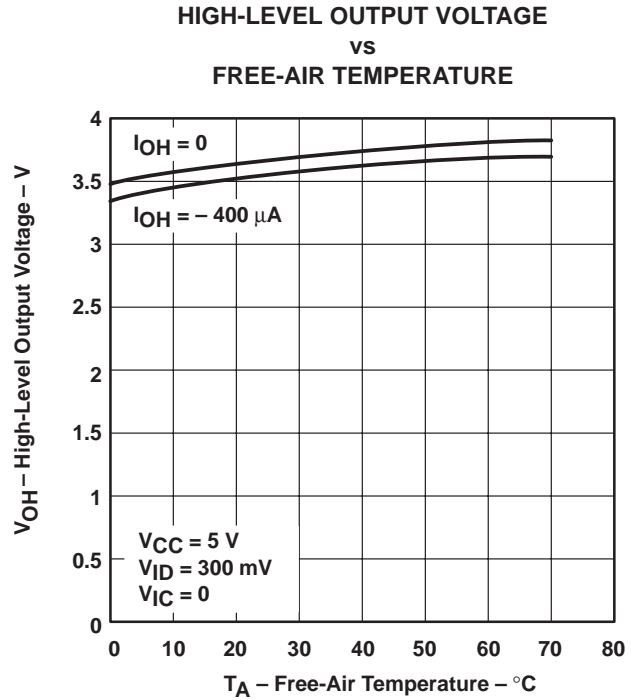
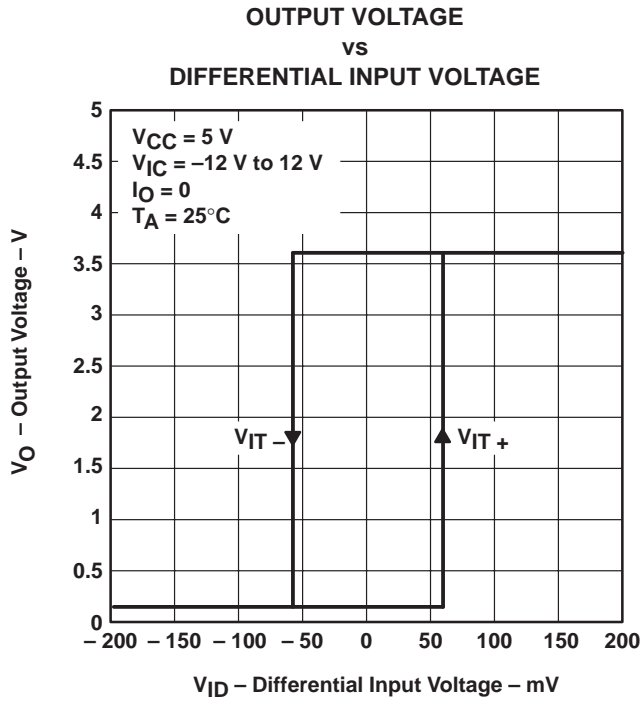

Figure 7

# SN75ALS197 QUADRUPLE DIFFERENTIAL LINE RECEIVER

SLLS045B – JANUARY 1989 – REVISED MAY 1995

## TYPICAL CHARACTERISTICS



TYPICAL CHARACTERISTICS

LOW-LEVEL OUTPUT VOLTAGE  
 vs  
 FREE-AIR TEMPERATURE

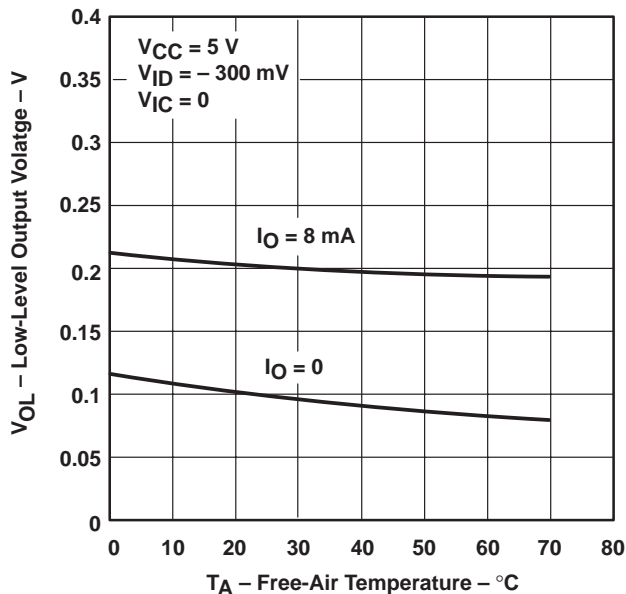

Figure 12

LOW-LEVEL OUTPUT VOLTAGE  
 vs  
 LOW-LEVEL OUTPUT CURRENT

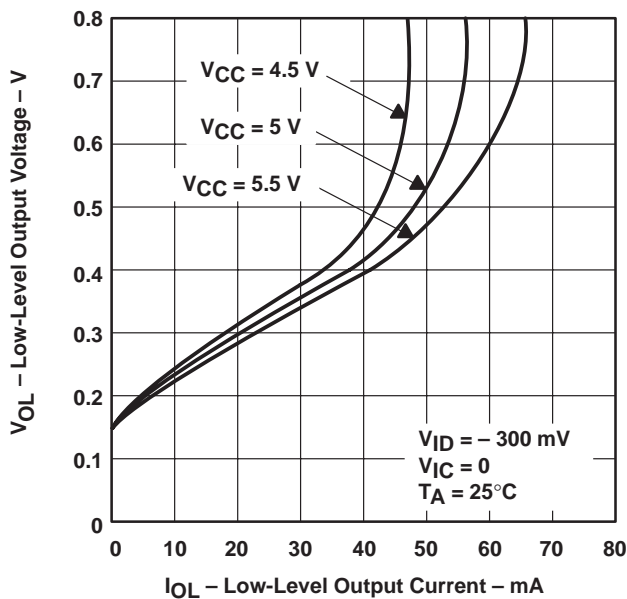

Figure 13

LOW-LEVEL OUTPUT VOLTAGE  
 vs  
 LOW-LEVEL OUTPUT CURRENT

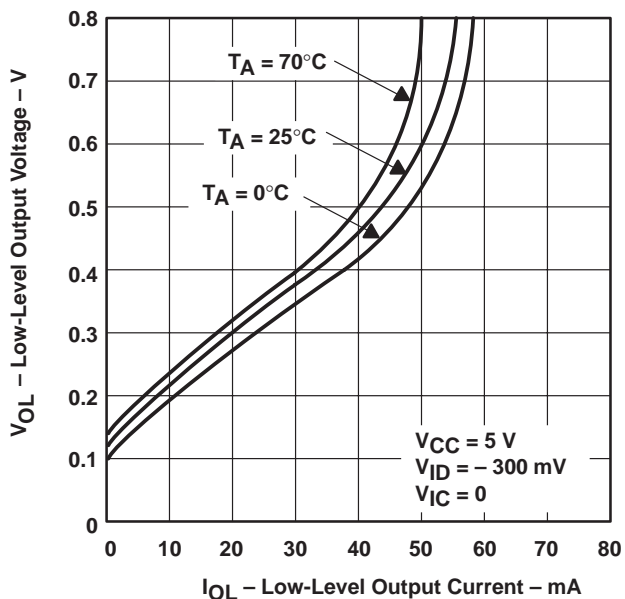

Figure 14

# SN75ALS197 QUADRUPLE DIFFERENTIAL LINE RECEIVER

SLLS045B – JANUARY 1989 – REVISED MAY 1995

## TYPICAL CHARACTERISTICS

**SUPPLY CURRENT  
vs  
SUPPLY VOLTAGE**

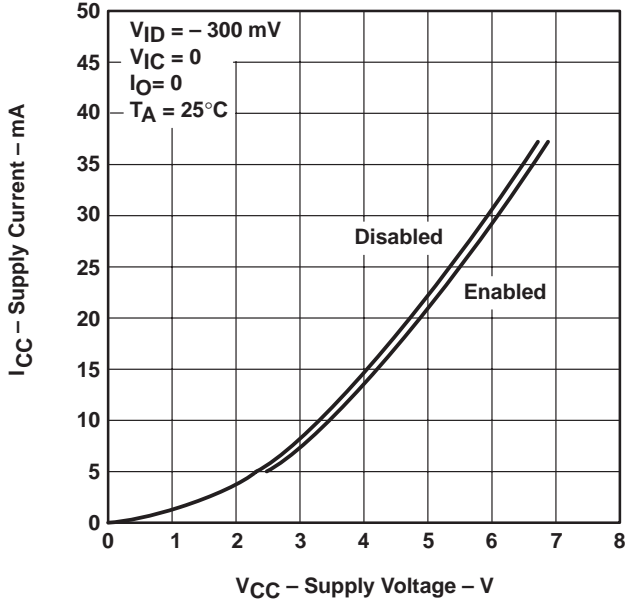

Figure 15

**SUPPLY CURRENT  
vs  
FREE-AIR TEMPERATURE**

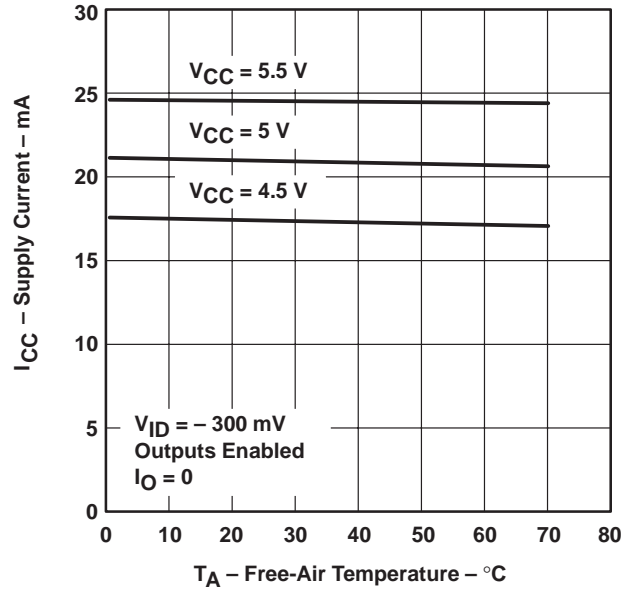

Figure 16

**SUPPLY CURRENT  
vs  
DIFFERENTIAL INPUT VOLTAGE**

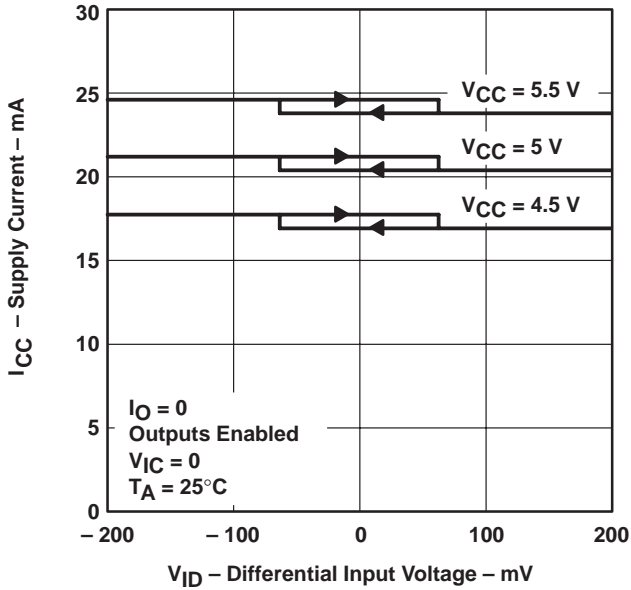

Figure 17

**SUPPLY CURRENT  
vs  
FREQUENCY**

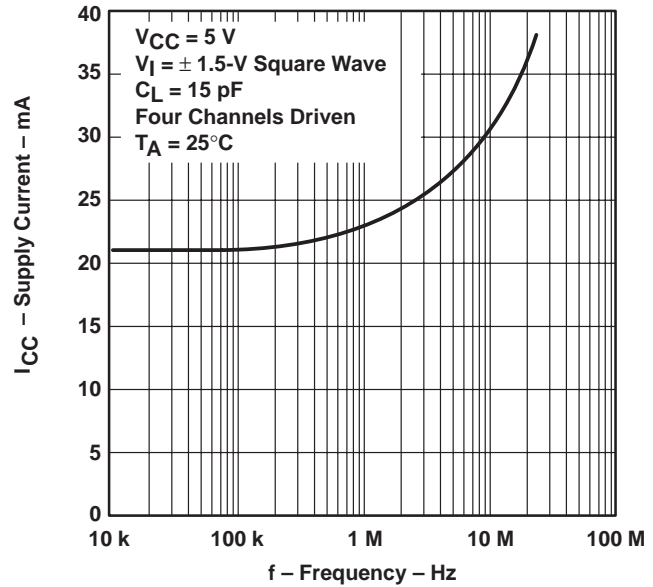

Figure 18



TYPICAL CHARACTERISTICS

INPUT RESISTANCE  
 vs  
 FREE-AIR TEMPERATURE

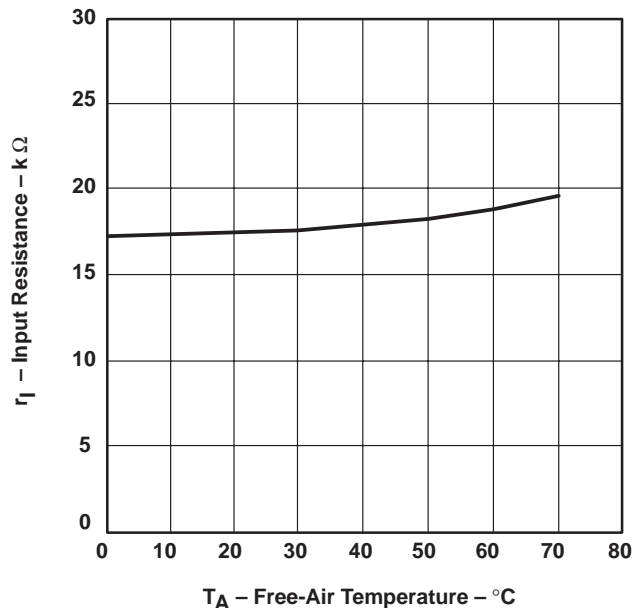

Figure 19

INPUT CURRENT  
 vs  
 INPUT VOLTAGE TO GND

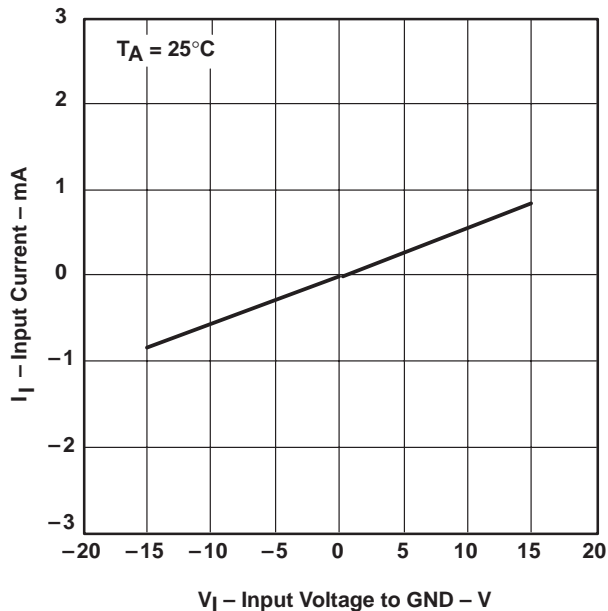

Figure 20

SWITCHING TIME  
 vs  
 FREE-AIR TEMPERATURE

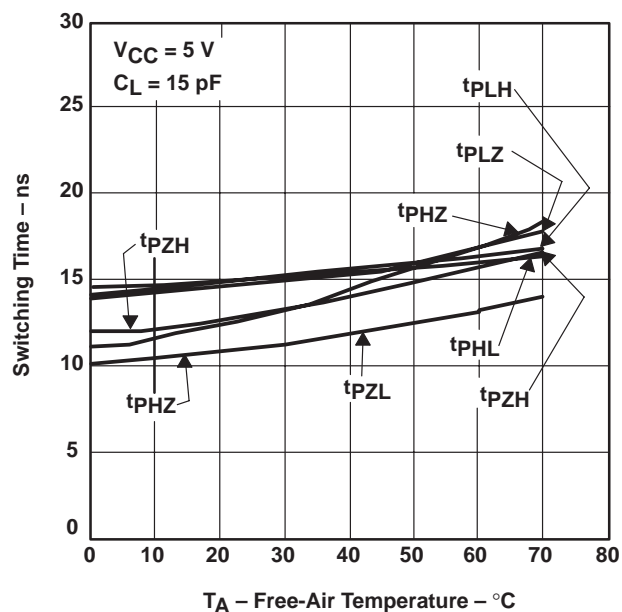

Figure 21

PROPAGATION DELAY TIME  
 vs  
 SUPPLY VOLTAGE

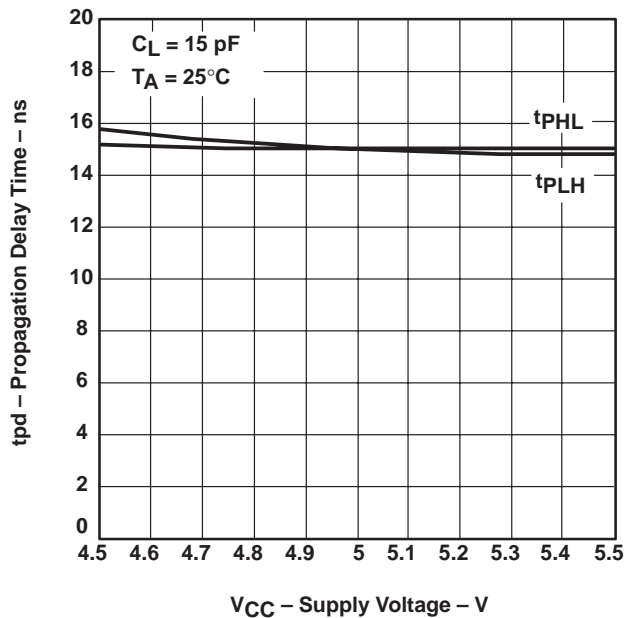

Figure 22

**PACKAGING INFORMATION**

Orderable Device	Status <sup>(1)</sup>	Package Type	Package Drawing	Pins	Package Qty	Eco Plan <sup>(2)</sup>	Lead/Ball Finish	MSL Peak Temp <sup>(3)</sup>
SN75ALS197D	ACTIVE	SOIC	D	16	40	Green (RoHS & no Sb/Br)	CU NIPDAU	Level-1-260C-UNLIM
SN75ALS197DE4	ACTIVE	SOIC	D	16	40	Green (RoHS & no Sb/Br)	CU NIPDAU	Level-1-260C-UNLIM
SN75ALS197DG4	ACTIVE	SOIC	D	16	40	Green (RoHS & no Sb/Br)	CU NIPDAU	Level-1-260C-UNLIM
SN75ALS197DR	ACTIVE	SOIC	D	16	2500	Green (RoHS & no Sb/Br)	CU NIPDAU	Level-1-260C-UNLIM
SN75ALS197DRE4	ACTIVE	SOIC	D	16	2500	Green (RoHS & no Sb/Br)	CU NIPDAU	Level-1-260C-UNLIM
SN75ALS197DRG4	ACTIVE	SOIC	D	16	2500	Green (RoHS & no Sb/Br)	CU NIPDAU	Level-1-260C-UNLIM
SN75ALS197J	OBSOLETE	CDIP	J	16		TBD	Call TI	Call TI
SN75ALS197N	ACTIVE	PDIP	N	16	25	Pb-Free (RoHS)	CU NIPDAU	N / A for Pkg Type
SN75ALS197NE4	ACTIVE	PDIP	N	16	25	Pb-Free (RoHS)	CU NIPDAU	N / A for Pkg Type
SN75ALS197NSR	ACTIVE	SO	NS	16	2000	Green (RoHS & no Sb/Br)	CU NIPDAU	Level-1-260C-UNLIM
SN75ALS197NSRE4	ACTIVE	SO	NS	16	2000	Green (RoHS & no Sb/Br)	CU NIPDAU	Level-1-260C-UNLIM
SN75ALS197NSRG4	ACTIVE	SO	NS	16	2000	Green (RoHS & no Sb/Br)	CU NIPDAU	Level-1-260C-UNLIM

<sup>(1)</sup> The marketing status values are defined as follows:

**ACTIVE:** Product device recommended for new designs.

**LIFEBUY:** TI has announced that the device will be discontinued, and a lifetime-buy period is in effect.

**NRND:** Not recommended for new designs. Device is in production to support existing customers, but TI does not recommend using this part in a new design.

**PREVIEW:** Device has been announced but is not in production. Samples may or may not be available.

**OBSOLETE:** TI has discontinued the production of the device.

<sup>(2)</sup> Eco Plan - The planned eco-friendly classification: Pb-Free (RoHS), Pb-Free (RoHS Exempt), or Green (RoHS & no Sb/Br) - please check <http://www.ti.com/productcontent> for the latest availability information and additional product content details.

**TBD:** The Pb-Free/Green conversion plan has not been defined.

**Pb-Free (RoHS):** TI's terms "Lead-Free" or "Pb-Free" mean semiconductor products that are compatible with the current RoHS requirements for all 6 substances, including the requirement that lead not exceed 0.1% by weight in homogeneous materials. Where designed to be soldered at high temperatures, TI Pb-Free products are suitable for use in specified lead-free processes.

**Pb-Free (RoHS Exempt):** This component has a RoHS exemption for either 1) lead-based flip-chip solder bumps used between the die and package, or 2) lead-based die adhesive used between the die and leadframe. The component is otherwise considered Pb-Free (RoHS compatible) as defined above.

**Green (RoHS & no Sb/Br):** TI defines "Green" to mean Pb-Free (RoHS compatible), and free of Bromine (Br) and Antimony (Sb) based flame retardants (Br or Sb do not exceed 0.1% by weight in homogeneous material)

<sup>(3)</sup> MSL, Peak Temp. -- The Moisture Sensitivity Level rating according to the JEDEC industry standard classifications, and peak solder temperature.

**Important Information and Disclaimer:** The information provided on this page represents TI's knowledge and belief as of the date that it is provided. TI bases its knowledge and belief on information provided by third parties, and makes no representation or warranty as to the accuracy of such information. Efforts are underway to better integrate information from third parties. TI has taken and continues to take reasonable steps to provide representative and accurate information but may not have conducted destructive testing or chemical analysis on incoming materials and chemicals. TI and TI suppliers consider certain information to be proprietary, and thus CAS numbers and other limited information may not be available for release.

In no event shall TI's liability arising out of such information exceed the total purchase price of the TI part(s) at issue in this document sold by TI to Customer on an annual basis.

## TAPE AND REEL INFORMATION

### REEL DIMENSIONS



### TAPE DIMENSIONS



A0	Dimension designed to accommodate the component width
B0	Dimension designed to accommodate the component length
K0	Dimension designed to accommodate the component thickness
W	Overall width of the carrier tape
P1	Pitch between successive cavity centers

### TAPE AND REEL INFORMATION

\*All dimensions are nominal

Device	Package Type	Package Drawing	Pins	SPQ	Reel Diameter (mm)	Reel Width W1 (mm)	A0 (mm)	B0 (mm)	K0 (mm)	P1 (mm)	W (mm)	Pin1 Quadrant
SN75ALS197DR	SOIC	D	16	2500	330.0	16.4	6.5	10.3	2.1	8.0	16.0	Q1
SN75ALS197NSR	SO	NS	16	2000	330.0	16.4	8.2	10.5	2.5	12.0	16.0	Q1

TAPE AND REEL BOX DIMENSIONS



\*All dimensions are nominal

Device	Package Type	Package Drawing	Pins	SPQ	Length (mm)	Width (mm)	Height (mm)
SN75ALS197DR	SOIC	D	16	2500	333.2	345.9	28.6
SN75ALS197NSR	SO	NS	16	2000	367.0	367.0	38.0

J (R-GDIP-T\*\*)

14 LEADS SHOWN

CERAMIC DUAL IN-LINE PACKAGE



DIM \ PINS **	14	16	18	20
A	0.300 (7,62) BSC	0.300 (7,62) BSC	0.300 (7,62) BSC	0.300 (7,62) BSC
B MAX	0.785 (19,94)	.840 (21,34)	0.960 (24,38)	1.060 (26,92)
B MIN	—	—	—	—
C MAX	0.300 (7,62)	0.300 (7,62)	0.310 (7,87)	0.300 (7,62)
C MIN	0.245 (6,22)	0.245 (6,22)	0.220 (5,59)	0.245 (6,22)



4040083/F 03/03

- NOTES:
- All linear dimensions are in inches (millimeters).
  - This drawing is subject to change without notice.
  - This package is hermetically sealed with a ceramic lid using glass frit.
  - Index point is provided on cap for terminal identification only on press ceramic glass frit seal only.
  - Falls within MIL STD 1835 GDIP1-T14, GDIP1-T16, GDIP1-T18 and GDIP1-T20.

N (R-PDIP-T\*\*)

PLASTIC DUAL-IN-LINE PACKAGE

16 PINS SHOWN



- NOTES:
- A. All linear dimensions are in inches (millimeters).
  - B. This drawing is subject to change without notice.
  - Falls within JEDEC MS-001, except 18 and 20 pin minimum body length (Dim A).
  - The 20 pin end lead shoulder width is a vendor option, either half or full width.

D (R-PDSO-G16)

PLASTIC SMALL OUTLINE



4040047-6/M 06/11

- NOTES:
- A. All linear dimensions are in inches (millimeters).
  - B. This drawing is subject to change without notice.
  -  Body length does not include mold flash, protrusions, or gate burrs. Mold flash, protrusions, or gate burrs shall not exceed 0.006 (0,15) each side.
  -  Body width does not include interlead flash. Interlead flash shall not exceed 0.017 (0,43) each side.
  - E. Reference JEDEC MS-012 variation AC.

D (R-PDSO-G16)

PLASTIC SMALL OUTLINE



4211283-4/E 08/12

- NOTES:
- All linear dimensions are in millimeters.
  - This drawing is subject to change without notice.
  - Publication IPC-7351 is recommended for alternate designs.
  - Laser cutting apertures with trapezoidal walls and also rounding corners will offer better paste release. Customers should contact their board assembly site for stencil design recommendations. Refer to IPC-7525 for other stencil recommendations.
  - Customers should contact their board fabrication site for solder mask tolerances between and around signal pads.

# MECHANICAL DATA

NS (R-PDSO-G\*\*)

PLASTIC SMALL-OUTLINE PACKAGE

14-PINS SHOWN



- NOTES:
- A. All linear dimensions are in millimeters.
  - B. This drawing is subject to change without notice.
  - C. Body dimensions do not include mold flash or protrusion, not to exceed 0,15.

## IMPORTANT NOTICE

Texas Instruments Incorporated and its subsidiaries (TI) reserve the right to make corrections, enhancements, improvements and other changes to its semiconductor products and services per JESD46, latest issue, and to discontinue any product or service per JESD48, latest issue. Buyers should obtain the latest relevant information before placing orders and should verify that such information is current and complete. All semiconductor products (also referred to herein as "components") are sold subject to TI's terms and conditions of sale supplied at the time of order acknowledgment.

TI warrants performance of its components to the specifications applicable at the time of sale, in accordance with the warranty in TI's terms and conditions of sale of semiconductor products. Testing and other quality control techniques are used to the extent TI deems necessary to support this warranty. Except where mandated by applicable law, testing of all parameters of each component is not necessarily performed.

TI assumes no liability for applications assistance or the design of Buyers' products. Buyers are responsible for their products and applications using TI components. To minimize the risks associated with Buyers' products and applications, Buyers should provide adequate design and operating safeguards.

TI does not warrant or represent that any license, either express or implied, is granted under any patent right, copyright, mask work right, or other intellectual property right relating to any combination, machine, or process in which TI components or services are used. Information published by TI regarding third-party products or services does not constitute a license to use such products or services or a warranty or endorsement thereof. Use of such information may require a license from a third party under the patents or other intellectual property of the third party, or a license from TI under the patents or other intellectual property of TI.

Reproduction of significant portions of TI information in TI data books or data sheets is permissible only if reproduction is without alteration and is accompanied by all associated warranties, conditions, limitations, and notices. TI is not responsible or liable for such altered documentation. Information of third parties may be subject to additional restrictions.

Resale of TI components or services with statements different from or beyond the parameters stated by TI for that component or service voids all express and any implied warranties for the associated TI component or service and is an unfair and deceptive business practice. TI is not responsible or liable for any such statements.

Buyer acknowledges and agrees that it is solely responsible for compliance with all legal, regulatory and safety-related requirements concerning its products, and any use of TI components in its applications, notwithstanding any applications-related information or support that may be provided by TI. Buyer represents and agrees that it has all the necessary expertise to create and implement safeguards which anticipate dangerous consequences of failures, monitor failures and their consequences, lessen the likelihood of failures that might cause harm and take appropriate remedial actions. Buyer will fully indemnify TI and its representatives against any damages arising out of the use of any TI components in safety-critical applications.

In some cases, TI components may be promoted specifically to facilitate safety-related applications. With such components, TI's goal is to help enable customers to design and create their own end-product solutions that meet applicable functional safety standards and requirements. Nonetheless, such components are subject to these terms.

No TI components are authorized for use in FDA Class III (or similar life-critical medical equipment) unless authorized officers of the parties have executed a special agreement specifically governing such use.

Only those TI components which TI has specifically designated as military grade or "enhanced plastic" are designed and intended for use in military/aerospace applications or environments. Buyer acknowledges and agrees that any military or aerospace use of TI components which have **not** been so designated is solely at the Buyer's risk, and that Buyer is solely responsible for compliance with all legal and regulatory requirements in connection with such use.

TI has specifically designated certain components which meet ISO/TS16949 requirements, mainly for automotive use. Components which have not been so designated are neither designed nor intended for automotive use; and TI will not be responsible for any failure of such components to meet such requirements.

### Products

Audio	<a href="http://www.ti.com/audio">www.ti.com/audio</a>
Amplifiers	<a href="http://amplifier.ti.com">amplifier.ti.com</a>
Data Converters	<a href="http://dataconverter.ti.com">dataconverter.ti.com</a>
DLP® Products	<a href="http://www.dlp.com">www.dlp.com</a>
DSP	<a href="http://dsp.ti.com">dsp.ti.com</a>
Clocks and Timers	<a href="http://www.ti.com/clocks">www.ti.com/clocks</a>
Interface	<a href="http://interface.ti.com">interface.ti.com</a>
Logic	<a href="http://logic.ti.com">logic.ti.com</a>
Power Mgmt	<a href="http://power.ti.com">power.ti.com</a>
Microcontrollers	<a href="http://microcontroller.ti.com">microcontroller.ti.com</a>
RFID	<a href="http://www.ti-rfid.com">www.ti-rfid.com</a>
OMAP Applications Processors	<a href="http://www.ti.com/omap">www.ti.com/omap</a>
Wireless Connectivity	<a href="http://www.ti.com/wirelessconnectivity">www.ti.com/wirelessconnectivity</a>

### Applications

Automotive and Transportation	<a href="http://www.ti.com/automotive">www.ti.com/automotive</a>
Communications and Telecom	<a href="http://www.ti.com/communications">www.ti.com/communications</a>
Computers and Peripherals	<a href="http://www.ti.com/computers">www.ti.com/computers</a>
Consumer Electronics	<a href="http://www.ti.com/consumer-apps">www.ti.com/consumer-apps</a>
Energy and Lighting	<a href="http://www.ti.com/energy">www.ti.com/energy</a>
Industrial	<a href="http://www.ti.com/industrial">www.ti.com/industrial</a>
Medical	<a href="http://www.ti.com/medical">www.ti.com/medical</a>
Security	<a href="http://www.ti.com/security">www.ti.com/security</a>
Space, Avionics and Defense	<a href="http://www.ti.com/space-avionics-defense">www.ti.com/space-avionics-defense</a>
Video and Imaging	<a href="http://www.ti.com/video">www.ti.com/video</a>

### TI E2E Community

[e2e.ti.com](http://e2e.ti.com)