

# SN75179B DIFFERENTIAL DRIVER AND RECEIVER PAIR

SLLS003E – OCTOBER 1985 – REVISED JUNE 1998

- Meets or Exceeds the Requirements of TIA/EIA-422-B, TIA/EIA-485-A, and ITU Recommendation V.11
- Bus Voltage Range . . . -7 V to 12 V
- Positive- and Negative-Current Limiting
- Driver Output Capability . . . 60 mA Max
- Driver Thermal-Shutdown Protection
- Receiver Input Impedance . . . 12 kΩ Min
- Receiver Input Sensitivity . . . ±200 mV
- Receiver Input Hysteresis . . . 50 mV Typ
- Operates From Single 5-V Supply
- Low Power Requirements

D OR P PACKAGE  
(TOP VIEW)

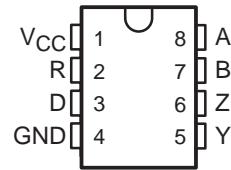

## description

The SN75179B is a differential driver and receiver pair designed for balanced transmission-line applications and meets TIA/EIA-422-B, TIA/EIA-485-A, and ITU Recommendation V.11. It is designed to improve the performance of full-duplex data communications over long bus lines.

The SN75179B driver output provides limiting for both positive and negative currents. The receiver features high input impedance, input hysteresis for increased noise immunity, and input sensitivity of ±200 mV over a common-mode input voltage range of -7 V to 12 V. The driver provides thermal shutdown for protection from line fault conditions. Thermal shutdown is designed to occur at a junction temperature of approximately 150°C. The SN75179B is designed to drive current loads of up to 60 mA maximum.

The SN75179B is characterized for operation from 0°C to 70°C.

## Function Tables

### DRIVER

INPUT D	OUTPUTS	
	Y	Z
H	H	L
L	L	H

### RECEIVER

DIFFERENTIAL INPUTS A - B	OUTPUT R
$V_{ID} \geq 0.2 \text{ V}$	H
$-0.2 \text{ V} < V_{ID} < 0.2 \text{ V}$	?
$V_{ID} \leq -0.2 \text{ V}$	L
Open	?

H = high level, L = low level, ? = indeterminate



Please be aware that an important notice concerning availability, standard warranty, and use in critical applications of Texas Instruments semiconductor products and disclaimers thereto appears at the end of this data sheet.

PRODUCTION DATA information is current as of publication date. Products conform to specifications per the terms of Texas Instruments standard warranty. Production processing does not necessarily include testing of all parameters.

 **TEXAS  
INSTRUMENTS**

POST OFFICE BOX 655303 • DALLAS, TEXAS 75265

Copyright © 1998, Texas Instruments Incorporated

# SN75179B DIFFERENTIAL DRIVER AND RECEIVER PAIR

SLLS003E – OCTOBER 1985 – REVISED JUNE 1998

## logic symbol†

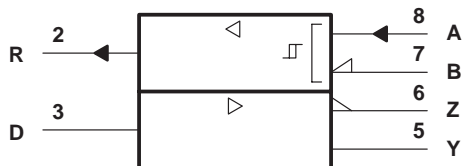

† This symbol is in accordance with ANSI/IEEE Std 91-1984 and IEC Publication 617-12.

## logic diagram (positive logic)

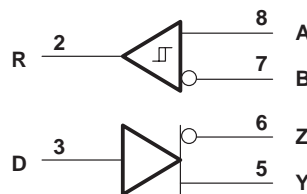

## schematics of inputs and outputs

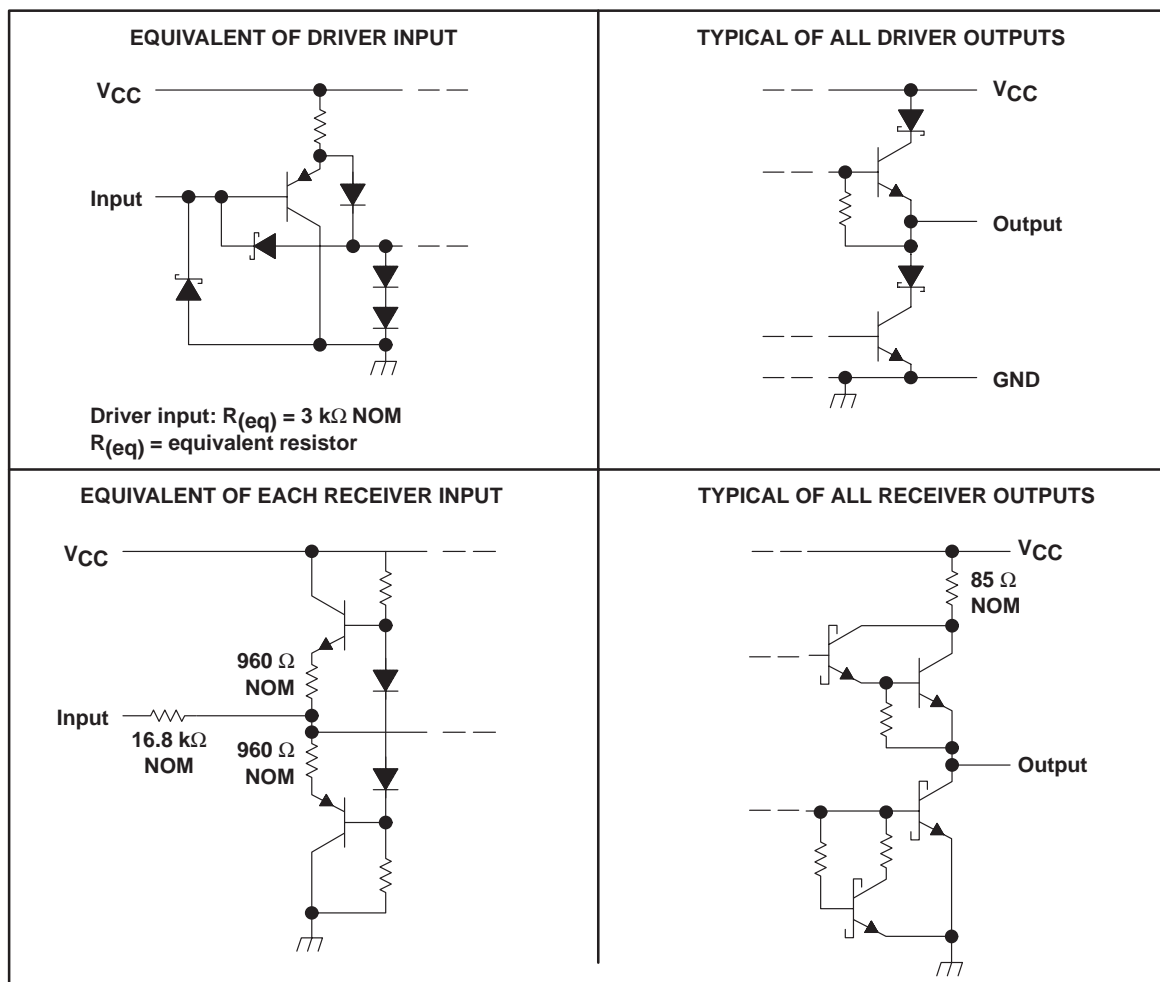

# SN75179B DIFFERENTIAL DRIVER AND RECEIVER PAIR

SLLS003E – OCTOBER 1985 – REVISED JUNE 1998

## absolute maximum ratings over operating free-air temperature range (unless otherwise noted)†

Supply voltage, $V_{CC}$ (see Note 1) .....	7 V
Voltage range at any bus terminal .....	–10 V to 15 V
Differential input voltage, $V_{ID}$ (see Note 2) .....	±25 V
Package thermal impedance, $\theta_{JA}$ (see Note 3):	D package .....
	P package .....
Storage temperature range, $T_{stg}$ .....	–65°C to 150°C
Lead temperature 1,6 mm (1/16 inch) from case for 10 seconds .....	260°C

† Stresses beyond those listed under “absolute maximum ratings” may cause permanent damage to the device. These are stress ratings only, and functional operation of the device at these or any other conditions beyond those indicated under “recommended operating conditions” is not implied. Exposure to absolute-maximum-rated conditions for extended periods may affect device reliability.

- NOTES:
1. All voltage values, except differential input voltage, are with respect to network ground terminal.
  2. Differential input voltage is measured at the noninverting input with respect to the corresponding inverting input.
  3. The package thermal impedance is calculated in accordance with JESD 51, except for through-hole packages, which use a trace length of zero.

## recommended operating conditions

		MIN	NOM	MAX	UNIT
Supply voltage, $V_{CC}$		4.75	5	5.25	V
High-level input voltage, $V_{IH}$	Driver	2			V
Low-level input voltage, $V_{IL}$	Driver			0.8	V
Common-mode input voltage, $V_{IC}$		–7‡		12	V
Differential input voltage, $V_{ID}$				±12	V
High-level output current, $I_{OH}$	Driver			–60	mA
	Receiver			–400	µA
Low-level output current, $I_{OL}$	Driver			60	mA
	Receiver			8	
Operating free-air temperature, $T_A$		0		70	°C

‡ The algebraic convention, where the less positive (more negative) limit is designated minimum, is used in this data sheet for common-mode input voltage and threshold voltage.



# SN75179B

## DIFFERENTIAL DRIVER AND RECEIVER PAIR

SLLS003E – OCTOBER 1985 – REVISED JUNE 1998

### DRIVER SECTION

electrical characteristics over recommended ranges of supply voltage and operating free-air temperature (unless otherwise noted)

PARAMETER	TEST CONDITIONS	MIN	TYP†	MAX	UNIT
$V_{IK}$ Input clamp voltage	$I_I = -18 \text{ mA}$			-1.5	V
$V_O$ Output voltage	$I_O = 0$	0		6	V
$ V_{OD1} $ Differential output voltage	$I_O = 0$	1.5		6	V
$ V_{OD2} $ Differential output voltage	$R_L = 100 \Omega$ , See Figure 1			$1/2 V_{OD1}$ or $2\ddagger$	V
	$R_L = 54 \Omega$ , See Figure 1	1.5	2.5	5	V
$ V_{OD3} $ Differential output voltage	See Note 4	1.5		5	V
$\Delta V_{OD} $ Change in magnitude of common-mode output voltage§				$\pm 0.2$	V
$V_{OC}$ Common-mode output voltage	$R_L = 54 \Omega$ or $100 \Omega$ , See Figure 1			3 -1	V
$\Delta V_{OC} $ Change in magnitude of common-mode output voltage§				$\pm 0.2$	V
$I_O$ Output current	$V_{CC} = 0$ , $V_O = -7 \text{ V to } 12 \text{ V}$			$\pm 100$	$\mu\text{A}$
$I_{IH}$ High-level input current	$V_I = 2.4 \text{ V}$			20	$\mu\text{A}$
$I_{IL}$ Low-level input current	$V_I = 0.4 \text{ V}$			-200	$\mu\text{A}$
$I_{OS}$ Short-circuit output current	$V_O = -7 \text{ V}$			-250	mA
	$V_O = V_{CC}$ or $12 \text{ V}$			250	
$I_{CC}$ Supply current (total package)	No load		57	70	mA

† All typical values are at  $V_{CC} = 5 \text{ V}$  and  $T_A = 25^\circ\text{C}$ .

‡ The minimum  $V_{OD2}$  with  $100\text{-}\Omega$  load is either  $1/2 V_{OD2}$  or  $2 \text{ V}$ , whichever is greater.

§  $\Delta|V_{OD}|$  and  $\Delta|V_{OC}|$  are the changes in magnitude of  $V_{OD}$  and  $V_{OC}$ , respectively, that occur when the input changes from a high level to a low level.

NOTE 4: See TIA/EIA-485-A, Figure 3.5, Test Termination Measurement 2.

### switching characteristics, $V_{CC} = 5 \text{ V}$ , $T_A = 25^\circ\text{C}$

PARAMETER	TEST CONDITIONS	MIN	TYP	MAX	UNIT
$t_{d(OD)}$ Differential output delay time	$R_L = 54 \Omega$ , See Figure 3		15	22	ns
$t_{t(OD)}$ Differential output transition time			20	30	ns

### Symbol Equivalents

DATA-SHEET PARAMETER	TIA/EIA-422-B	TIA/EIA-485-A
$V_O$	$V_{Oa}, V_{Ob}$	$V_{Oa}, V_{Ob}$
$ V_{OD1} $	$V_o$	$V_o$
$ V_{OD2} $	$V_t (R_L = 100 \Omega)$	$V_t (R_L = 54 \Omega)$
$ V_{OD3} $		$V_t$ (Test Termination Measurement 2)
$\Delta V_{OD} $	$  V_t  -  \bar{V}_t  $	$  V_t  -  \bar{V}_t  $
$V_{OC}$	$ V_{os} $	$ V_{os} $
$\Delta V_{OC} $	$ V_{os} - \bar{V}_{os} $	$ V_{os} - \bar{V}_{os} $
$I_{OS}$	$ I_{sa} ,  I_{sb} $	
$I_O$	$ I_{xa} ,  I_{xb} $	$I_{ia}, I_{ib}$



## RECEIVER SECTION

**electrical characteristics over recommended ranges of common-mode input voltage, supply voltage, and operating free-air temperature (unless otherwise noted)**

PARAMETER	TEST CONDITIONS	MIN	TYP†	MAX	UNIT
$V_{IT+}$ Positive-going input threshold voltage	$V_O = 2.7\text{ V}$ , $I_O = -0.4\text{ mA}$			0.2	V
$V_{IT-}$ Negative-going input threshold voltage	$V_O = 0.5\text{ V}$ , $I_O = 8\text{ mA}$	-0.2‡			V
$V_{hys}$ Hysteresis voltage ( $V_{IT+} - V_{IT-}$ )			50		mV
$V_{OH}$ High-level output voltage	$V_{ID} = 200\text{ mV}$ , $I_{OH} = -400\text{ }\mu\text{A}$ , See Figure 2		2.7		V
$V_{OL}$ Low-level output voltage	$V_{ID} = -200\text{ mV}$ , $I_{OL} = 8\text{ mA}$ , See Figure 2			0.45	V
$I_I$ Line input current	Other input at 0 V, See Note 5				mA
	$V_I = 12\text{ V}$			1	
	$V_I = -7\text{ V}$			-0.8	
$r_i$ Input resistance			12		k $\Omega$
$I_{OS}$ Short-circuit output current		-15		-85	mA
$I_{CC}$ Supply current (total package)	No load		57	70	mA

† All typical values are at  $V_{CC} = 5\text{ V}$ ,  $T_A = 25^\circ\text{C}$ .

‡ The algebraic convention, where the less positive (more negative) limit is designated minimum, is used in this data sheet for common-mode input voltage and threshold voltage levels only.

NOTE 5: Refer to TIA/EIA-422-B for exact conditions.

**switching characteristics,  $V_{CC} = 5\text{ V}$ ,  $T_A = 25^\circ\text{C}$**

PARAMETER	TEST CONDITIONS	MIN	TYP	MAX	UNIT
$t_{PLH}$ Propagation delay time, low- to high-level output	$V_{ID} = -1.5\text{ V}$ to $1.5\text{ V}$ , $C_L = 15\text{ pF}$ , See Figure 4		19	35	ns
$t_{PHL}$ Propagation delay time, high- to low-level output			30	40	ns

## PARAMETER MEASUREMENT INFORMATION

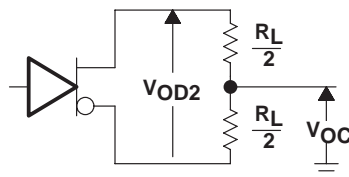

Figure 1. Driver  $V_{DD}$  and  $V_{OC}$

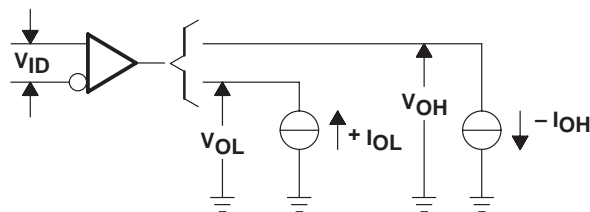
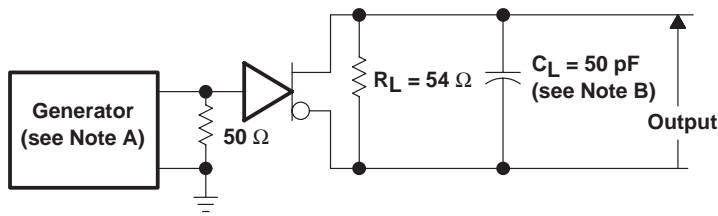

Figure 2. Receiver  $V_{OH}$  and  $V_{OL}$

# SN75179B DIFFERENTIAL DRIVER AND RECEIVER PAIR

SLLS003E – OCTOBER 1985 – REVISED JUNE 1998

## PARAMETER MEASUREMENT INFORMATION (CONTINUED)



TEST CIRCUIT

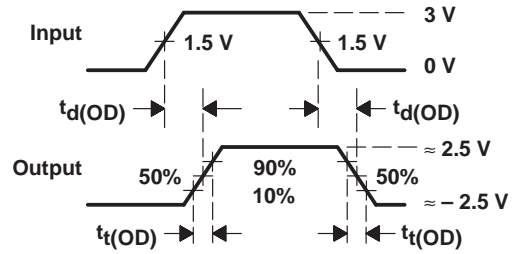

VOLTAGE WAVEFORMS

- NOTES: A. The input pulse is supplied by a generator having the following characteristics:  $\text{PRR} \leq 1 \text{ MHz}$ , 50% duty cycle,  $t_r \leq 6 \text{ ns}$ ,  $t_f \leq 6 \text{ ns}$ ,  $Z_O = 50 \Omega$ .  
B.  $C_L$  includes probe and jig capacitance.

Figure 3. Driver Test Circuit and Voltage Waveforms

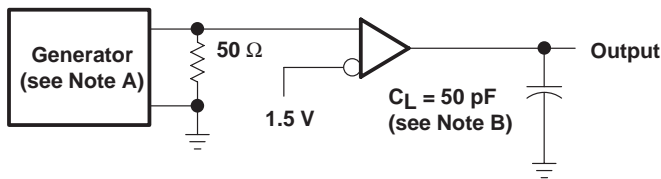

TEST CIRCUIT

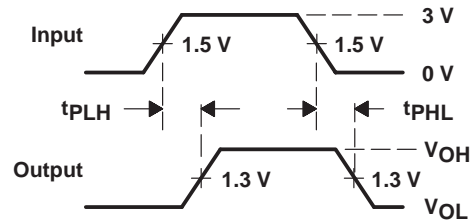

VOLTAGE WAVEFORMS

- NOTES: A. The input pulse is supplied by a generator having the following characteristics:  $\text{PRR} \leq 1 \text{ MHz}$ , 50% duty cycle,  $t_r \leq 6 \text{ ns}$ ,  $t_f \leq 6 \text{ ns}$ ,  $Z_O = 50 \Omega$ .  
B.  $C_L$  includes probe and jig capacitance.

Figure 4. Receiver Test Circuit and Voltage Waveforms

TYPICAL CHARACTERISTICS

DRIVER  
HIGH-LEVEL OUTPUT VOLTAGE  
vs  
HIGH-LEVEL OUTPUT CURRENT

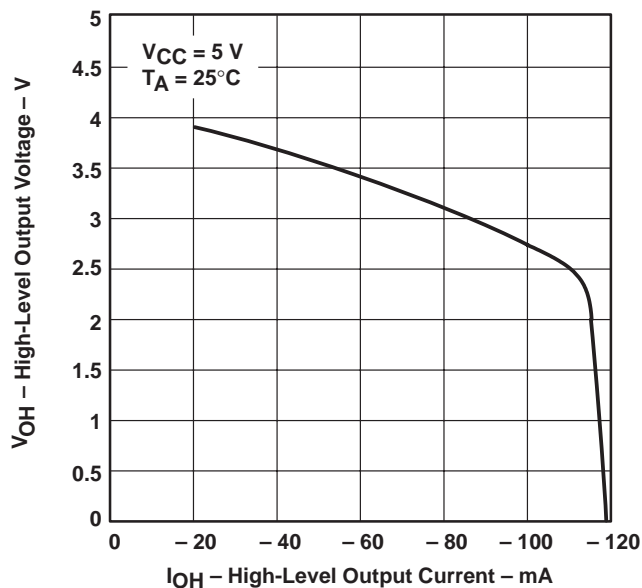

Figure 5

DRIVER  
LOW-LEVEL OUTPUT VOLTAGE  
vs  
LOW-LEVEL OUTPUT CURRENT

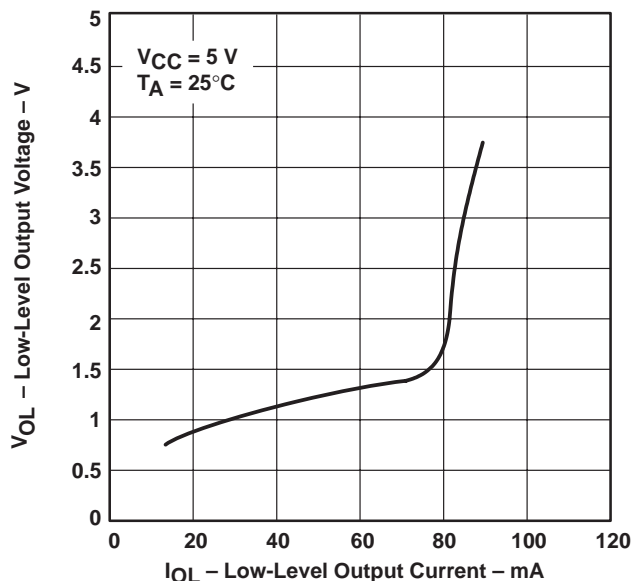

Figure 6

DRIVER  
DIFFERENTIAL OUTPUT VOLTAGE  
vs  
OUTPUT CURRENT

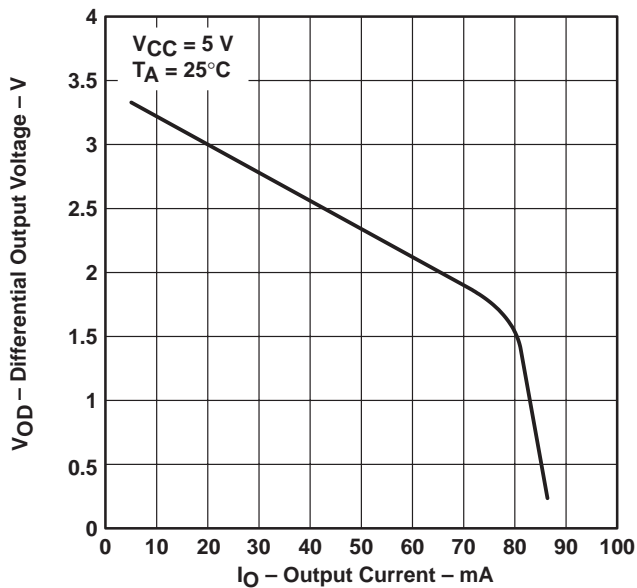

Figure 7

RECEIVER  
OUTPUT VOLTAGE  
vs  
DIFFERENTIAL INPUT VOLTAGE

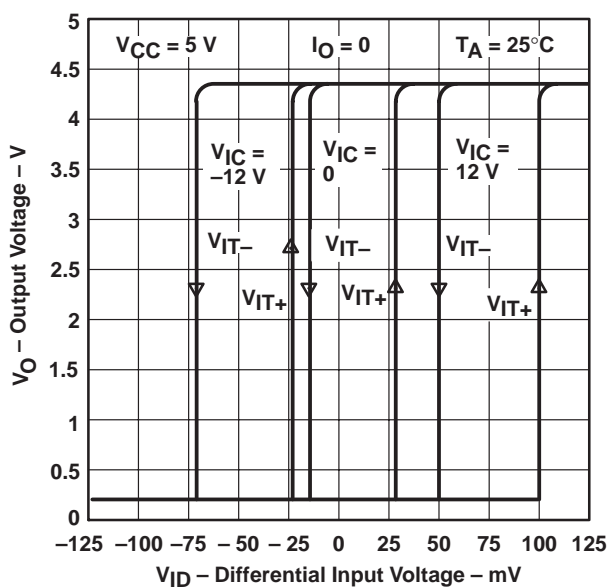

Figure 8

# SN75179B DIFFERENTIAL DRIVER AND RECEIVER PAIR

SLLS003E – OCTOBER 1985 – REVISED JUNE 1998

## TYPICAL CHARACTERISTICS

HIGH-LEVEL OUTPUT VOLTAGE  
vs  
HIGH-LEVEL OUTPUT CURRENT

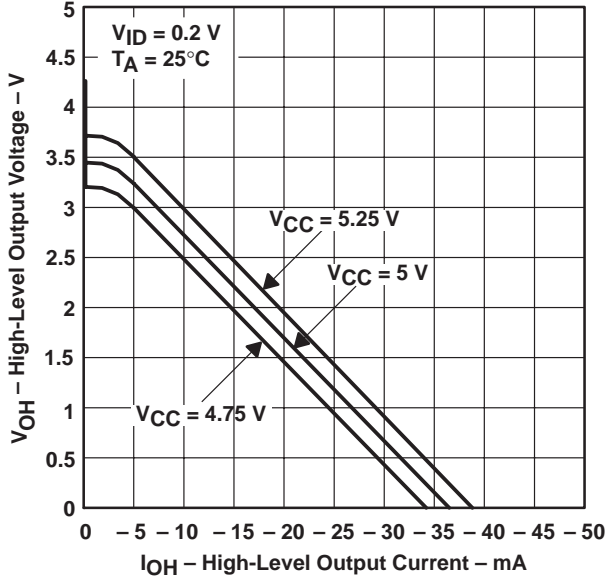

Figure 9

HIGH-LEVEL OUTPUT VOLTAGE  
vs  
FREE-AIR TEMPERATURE

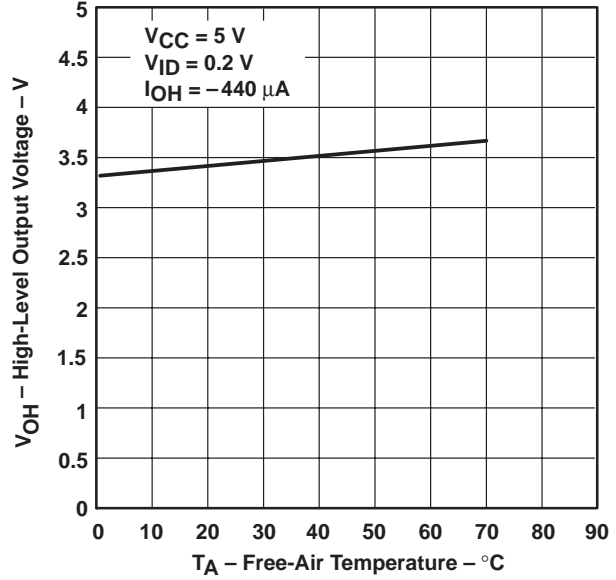

Figure 10

RECEIVER  
LOW-LEVEL OUTPUT VOLTAGE  
vs  
LOW-LEVEL OUTPUT CURRENT

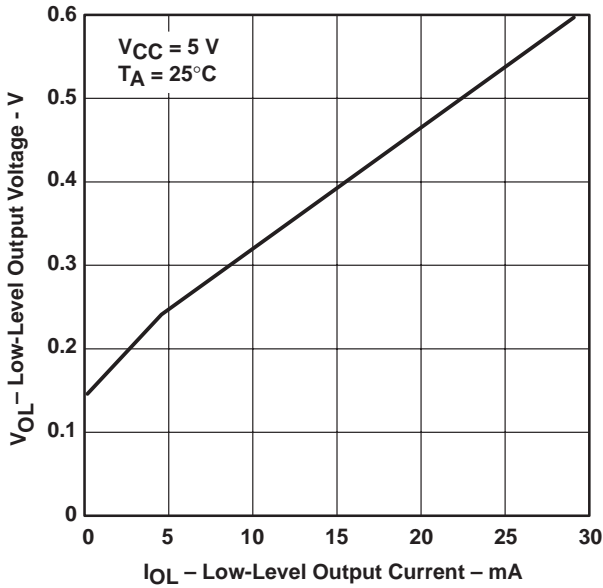

Figure 11

RECEIVER  
LOW-LEVEL OUTPUT VOLTAGE  
vs  
FREE-AIR TEMPERATURE

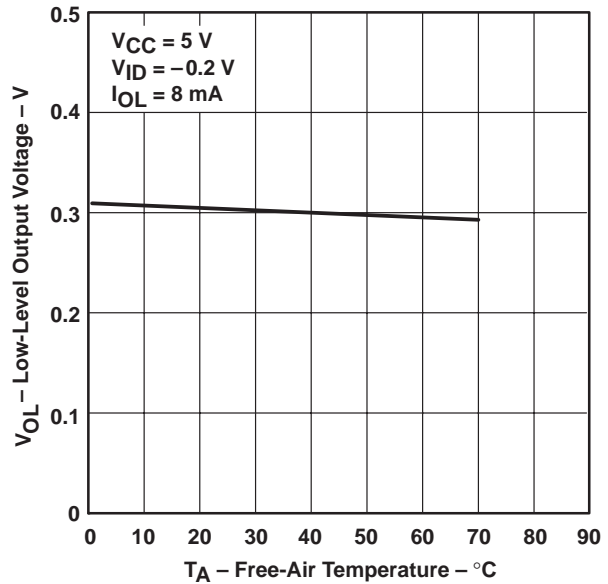

Figure 12

## IMPORTANT NOTICE

Texas Instruments Incorporated and its subsidiaries (TI) reserve the right to make corrections, modifications, enhancements, improvements, and other changes to its products and services at any time and to discontinue any product or service without notice. Customers should obtain the latest relevant information before placing orders and should verify that such information is current and complete. All products are sold subject to TI's terms and conditions of sale supplied at the time of order acknowledgment.

TI warrants performance of its hardware products to the specifications applicable at the time of sale in accordance with TI's standard warranty. Testing and other quality control techniques are used to the extent TI deems necessary to support this warranty. Except where mandated by government requirements, testing of all parameters of each product is not necessarily performed.

TI assumes no liability for applications assistance or customer product design. Customers are responsible for their products and applications using TI components. To minimize the risks associated with customer products and applications, customers should provide adequate design and operating safeguards.

TI does not warrant or represent that any license, either express or implied, is granted under any TI patent right, copyright, mask work right, or other TI intellectual property right relating to any combination, machine, or process in which TI products or services are used. Information published by TI regarding third-party products or services does not constitute a license from TI to use such products or services or a warranty or endorsement thereof. Use of such information may require a license from a third party under the patents or other intellectual property of the third party, or a license from TI under the patents or other intellectual property of TI.

Reproduction of information in TI data books or data sheets is permissible only if reproduction is without alteration and is accompanied by all associated warranties, conditions, limitations, and notices. Reproduction of this information with alteration is an unfair and deceptive business practice. TI is not responsible or liable for such altered documentation.

Resale of TI products or services with statements different from or beyond the parameters stated by TI for that product or service voids all express and any implied warranties for the associated TI product or service and is an unfair and deceptive business practice. TI is not responsible or liable for any such statements.

TI products are not authorized for use in safety-critical applications (such as life support) where a failure of the TI product would reasonably be expected to cause severe personal injury or death, unless officers of the parties have executed an agreement specifically governing such use. Buyers represent that they have all necessary expertise in the safety and regulatory ramifications of their applications, and acknowledge and agree that they are solely responsible for all legal, regulatory and safety-related requirements concerning their products and any use of TI products in such safety-critical applications, notwithstanding any applications-related information or support that may be provided by TI. Further, Buyers must fully indemnify TI and its representatives against any damages arising out of the use of TI products in such safety-critical applications.

TI products are neither designed nor intended for use in military/aerospace applications or environments unless the TI products are specifically designated by TI as military-grade or "enhanced plastic." Only products designated by TI as military-grade meet military specifications. Buyers acknowledge and agree that any such use of TI products which TI has not designated as military-grade is solely at the Buyer's risk, and that they are solely responsible for compliance with all legal and regulatory requirements in connection with such use.

TI products are neither designed nor intended for use in automotive applications or environments unless the specific TI products are designated by TI as compliant with ISO/TS 16949 requirements. Buyers acknowledge and agree that, if they use any non-designated products in automotive applications, TI will not be responsible for any failure to meet such requirements.

Following are URLs where you can obtain information on other Texas Instruments products and application solutions:

<b>Products</b>		<b>Applications</b>	
Amplifiers	<a href="http://amplifier.ti.com">amplifier.ti.com</a>	Audio	<a href="http://www.ti.com/audio">www.ti.com/audio</a>
Data Converters	<a href="http://dataconverter.ti.com">dataconverter.ti.com</a>	Automotive	<a href="http://www.ti.com/automotive">www.ti.com/automotive</a>
DSP	<a href="http://dsp.ti.com">dsp.ti.com</a>	Broadband	<a href="http://www.ti.com/broadband">www.ti.com/broadband</a>
Interface	<a href="http://interface.ti.com">interface.ti.com</a>	Digital Control	<a href="http://www.ti.com/digitalcontrol">www.ti.com/digitalcontrol</a>
Logic	<a href="http://logic.ti.com">logic.ti.com</a>	Military	<a href="http://www.ti.com/military">www.ti.com/military</a>
Power Mgmt	<a href="http://power.ti.com">power.ti.com</a>	Optical Networking	<a href="http://www.ti.com/opticalnetwork">www.ti.com/opticalnetwork</a>
Microcontrollers	<a href="http://microcontroller.ti.com">microcontroller.ti.com</a>	Security	<a href="http://www.ti.com/security">www.ti.com/security</a>
Low Power Wireless	<a href="http://www.ti.com/lpw">www.ti.com/lpw</a>	Telephony	<a href="http://www.ti.com/telephony">www.ti.com/telephony</a>
		Video & Imaging	<a href="http://www.ti.com/video">www.ti.com/video</a>
		Wireless	<a href="http://www.ti.com/wireless">www.ti.com/wireless</a>

Mailing Address: Texas Instruments, Post Office Box 655303, Dallas, Texas 75265  
Copyright © 2007, Texas Instruments Incorporated

**PACKAGING INFORMATION**

Orderable Device	Status <sup>(1)</sup>	Package Type	Package Drawing	Pins	Package Qty	Eco Plan <sup>(2)</sup>	Lead/Ball Finish	MSL Peak Temp <sup>(3)</sup>
SN75179BD	ACTIVE	SOIC	D	8	75	Green (RoHS & no Sb/Br)	CU NIPDAU	Level-1-260C-UNLIM
SN75179BDE4	ACTIVE	SOIC	D	8	75	Green (RoHS & no Sb/Br)	CU NIPDAU	Level-1-260C-UNLIM
SN75179BDG4	ACTIVE	SOIC	D	8	75	Green (RoHS & no Sb/Br)	CU NIPDAU	Level-1-260C-UNLIM
SN75179BDR	ACTIVE	SOIC	D	8	2500	Green (RoHS & no Sb/Br)	CU NIPDAU	Level-1-260C-UNLIM
SN75179BDRE4	ACTIVE	SOIC	D	8	2500	Green (RoHS & no Sb/Br)	CU NIPDAU	Level-1-260C-UNLIM
SN75179BDRG4	ACTIVE	SOIC	D	8	2500	Green (RoHS & no Sb/Br)	CU NIPDAU	Level-1-260C-UNLIM
SN75179BP	ACTIVE	PDIP	P	8	50	Pb-Free (RoHS)	CU NIPDAU	N / A for Pkg Type
SN75179BPE4	ACTIVE	PDIP	P	8	50	Pb-Free (RoHS)	CU NIPDAU	N / A for Pkg Type
SN75179BPSR	ACTIVE	SO	PS	8	2000	Green (RoHS & no Sb/Br)	CU NIPDAU	Level-1-260C-UNLIM
SN75179BPSRE4	ACTIVE	SO	PS	8	2000	Green (RoHS & no Sb/Br)	CU NIPDAU	Level-1-260C-UNLIM
SN75179BPSRG4	ACTIVE	SO	PS	8	2000	Green (RoHS & no Sb/Br)	CU NIPDAU	Level-1-260C-UNLIM

<sup>(1)</sup> The marketing status values are defined as follows:

**ACTIVE:** Product device recommended for new designs.

**LIFEBUY:** TI has announced that the device will be discontinued, and a lifetime-buy period is in effect.

**NRND:** Not recommended for new designs. Device is in production to support existing customers, but TI does not recommend using this part in a new design.

**PREVIEW:** Device has been announced but is not in production. Samples may or may not be available.

**OBSOLETE:** TI has discontinued the production of the device.

<sup>(2)</sup> Eco Plan - The planned eco-friendly classification: Pb-Free (RoHS), Pb-Free (RoHS Exempt), or Green (RoHS & no Sb/Br) - please check <http://www.ti.com/productcontent> for the latest availability information and additional product content details.

**TBD:** The Pb-Free/Green conversion plan has not been defined.

**Pb-Free (RoHS):** TI's terms "Lead-Free" or "Pb-Free" mean semiconductor products that are compatible with the current RoHS requirements for all 6 substances, including the requirement that lead not exceed 0.1% by weight in homogeneous materials. Where designed to be soldered at high temperatures, TI Pb-Free products are suitable for use in specified lead-free processes.

**Pb-Free (RoHS Exempt):** This component has a RoHS exemption for either 1) lead-based flip-chip solder bumps used between the die and package, or 2) lead-based die adhesive used between the die and leadframe. The component is otherwise considered Pb-Free (RoHS compatible) as defined above.

**Green (RoHS & no Sb/Br):** TI defines "Green" to mean Pb-Free (RoHS compatible), and free of Bromine (Br) and Antimony (Sb) based flame retardants (Br or Sb do not exceed 0.1% by weight in homogeneous material)

<sup>(3)</sup> MSL, Peak Temp. -- The Moisture Sensitivity Level rating according to the JEDEC industry standard classifications, and peak solder temperature.

**Important Information and Disclaimer:**The information provided on this page represents TI's knowledge and belief as of the date that it is provided. TI bases its knowledge and belief on information provided by third parties, and makes no representation or warranty as to the accuracy of such information. Efforts are underway to better integrate information from third parties. TI has taken and continues to take reasonable steps to provide representative and accurate information but may not have conducted destructive testing or chemical analysis on incoming materials and chemicals. TI and TI suppliers consider certain information to be proprietary, and thus CAS numbers and other limited information may not be available for release.

In no event shall TI's liability arising out of such information exceed the total purchase price of the TI part(s) at issue in this document sold by TI

to Customer on an annual basis.

**TAPE AND REEL INFORMATION**



**QUADRANT ASSIGNMENTS FOR PIN 1 ORIENTATION IN TAPE**



\*All dimensions are nominal

Device	Package Type	Package Drawing	Pins	SPQ	Reel Diameter (mm)	Reel Width W1 (mm)	A0 (mm)	B0 (mm)	K0 (mm)	P1 (mm)	W (mm)	Pin1 Quadrant
SN75179BDR	SOIC	D	8	2500	330.0	12.4	6.4	5.2	2.1	8.0	12.0	Q1
SN75179BPSR	SO	PS	8	2000	330.0	16.4	8.2	6.6	2.5	12.0	16.0	Q1

**TAPE AND REEL BOX DIMENSIONS**



\*All dimensions are nominal

Device	Package Type	Package Drawing	Pins	SPQ	Length (mm)	Width (mm)	Height (mm)
SN75179BDR	SOIC	D	8	2500	340.5	338.1	20.6
SN75179BPSR	SO	PS	8	2000	346.0	346.0	33.0

D (R-PDSO-G8)

PLASTIC SMALL-OUTLINE PACKAGE

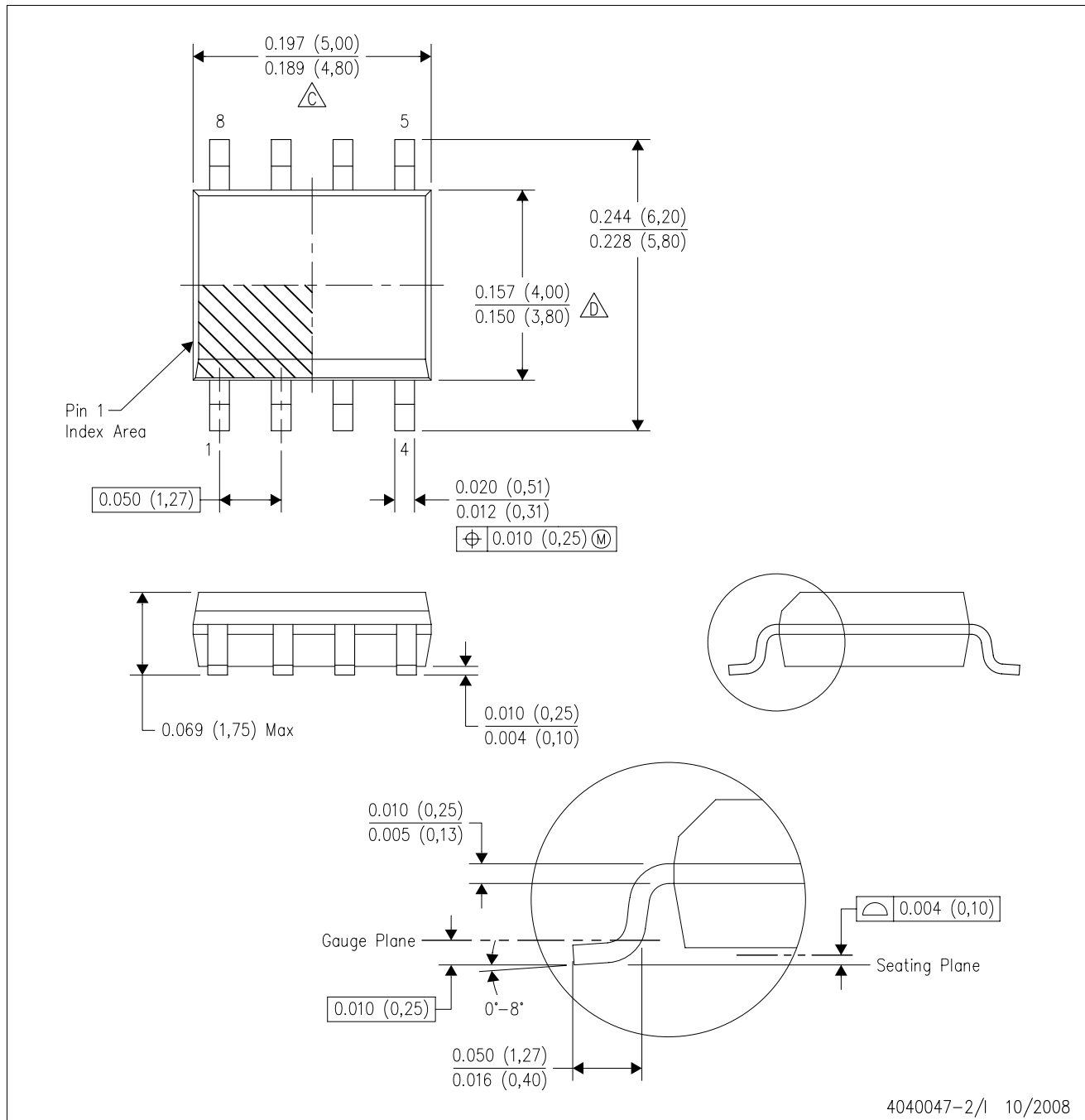

- NOTES:
- A. All linear dimensions are in inches (millimeters).
  - B. This drawing is subject to change without notice.
  - C. Body length does not include mold flash, protrusions, or gate burrs. Mold flash, protrusions, or gate burrs shall not exceed .006 (0,15) per end.
  - D. Body width does not include interlead flash. Interlead flash shall not exceed .017 (0,43) per side.
  - E. Reference JEDEC MS-012 variation AA.

## MECHANICAL DATA

PS (R-PDSO-G8)

PLASTIC SMALL-OUTLINE PACKAGE

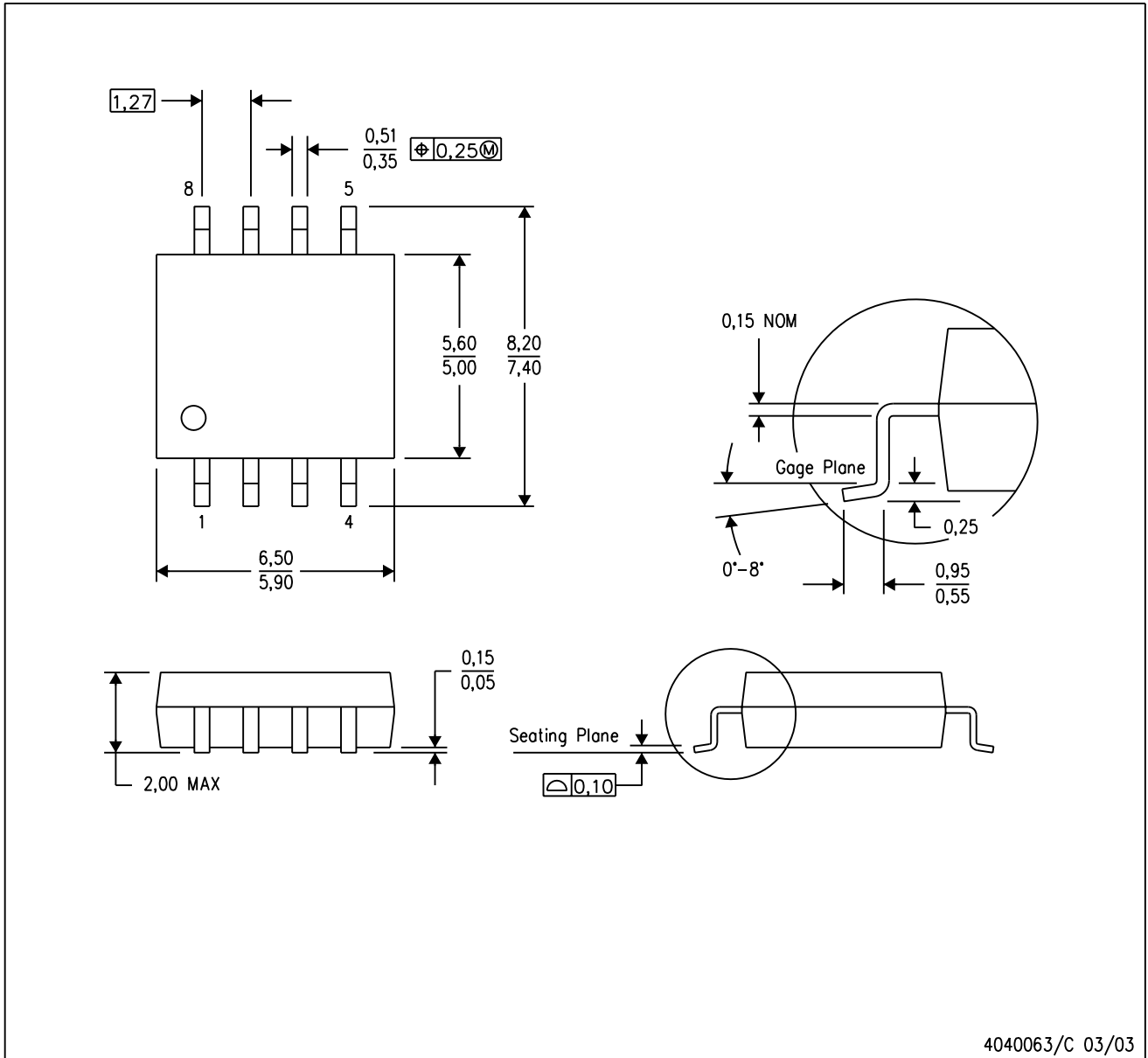

- NOTES:
- A. All linear dimensions are in millimeters.
  - B. This drawing is subject to change without notice.
  - C. Body dimensions do not include mold flash or protrusion, not to exceed 0,15.

P (R-PDIP-T8)

PLASTIC DUAL-IN-LINE

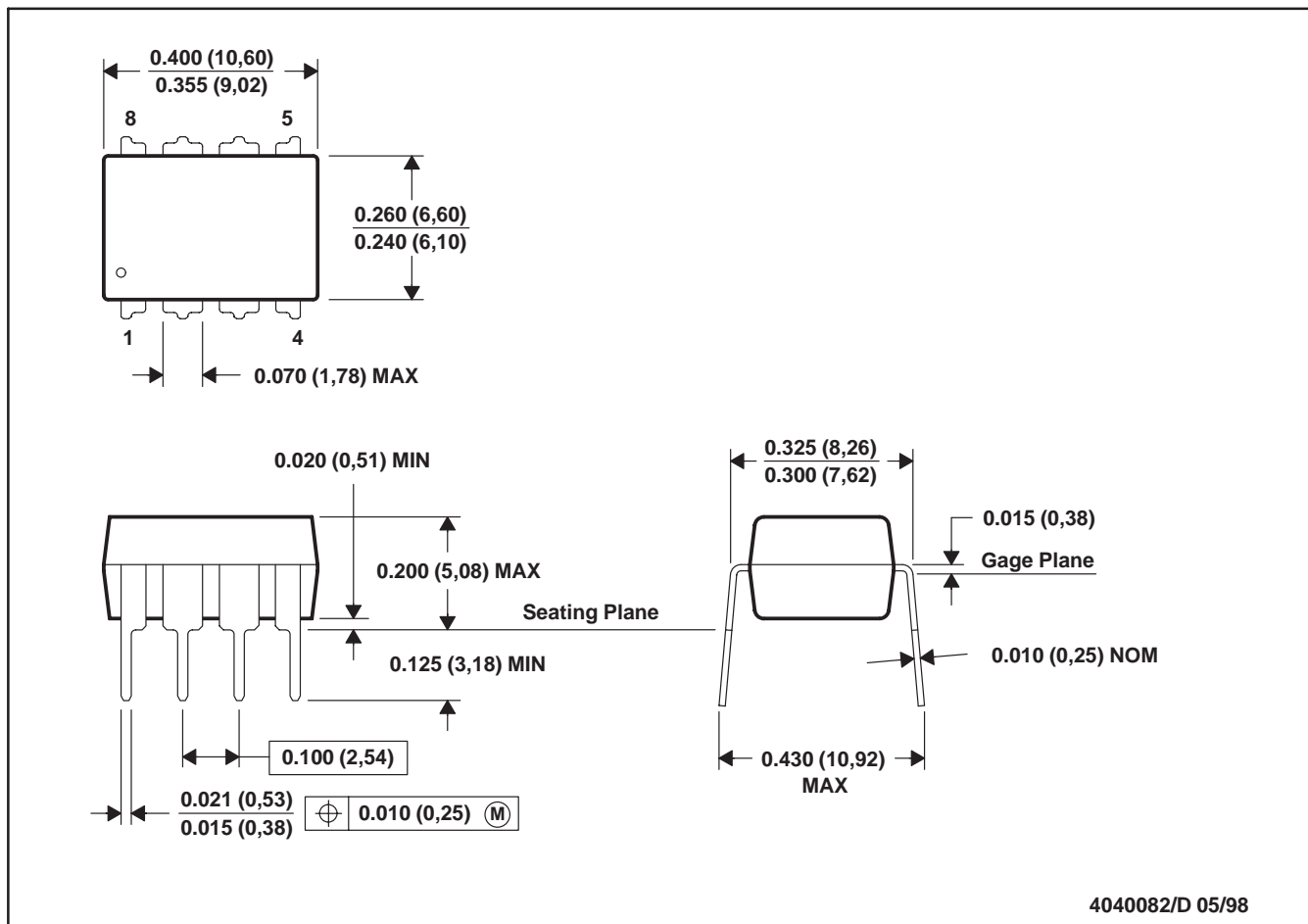

- NOTES: A. All linear dimensions are in inches (millimeters).  
 B. This drawing is subject to change without notice.  
 C. Falls within JEDEC MS-001

For the latest package information, go to [http://www.ti.com/sc/docs/package/pkg\\_info.htm](http://www.ti.com/sc/docs/package/pkg_info.htm)

## IMPORTANT NOTICE

Texas Instruments Incorporated and its subsidiaries (TI) reserve the right to make corrections, modifications, enhancements, improvements, and other changes to its products and services at any time and to discontinue any product or service without notice. Customers should obtain the latest relevant information before placing orders and should verify that such information is current and complete. All products are sold subject to TI's terms and conditions of sale supplied at the time of order acknowledgment.

TI warrants performance of its hardware products to the specifications applicable at the time of sale in accordance with TI's standard warranty. Testing and other quality control techniques are used to the extent TI deems necessary to support this warranty. Except where mandated by government requirements, testing of all parameters of each product is not necessarily performed.

TI assumes no liability for applications assistance or customer product design. Customers are responsible for their products and applications using TI components. To minimize the risks associated with customer products and applications, customers should provide adequate design and operating safeguards.

TI does not warrant or represent that any license, either express or implied, is granted under any TI patent right, copyright, mask work right, or other TI intellectual property right relating to any combination, machine, or process in which TI products or services are used. Information published by TI regarding third-party products or services does not constitute a license from TI to use such products or services or a warranty or endorsement thereof. Use of such information may require a license from a third party under the patents or other intellectual property of the third party, or a license from TI under the patents or other intellectual property of TI.

Reproduction of TI information in TI data books or data sheets is permissible only if reproduction is without alteration and is accompanied by all associated warranties, conditions, limitations, and notices. Reproduction of this information with alteration is an unfair and deceptive business practice. TI is not responsible or liable for such altered documentation. Information of third parties may be subject to additional restrictions.

Resale of TI products or services with statements different from or beyond the parameters stated by TI for that product or service voids all express and any implied warranties for the associated TI product or service and is an unfair and deceptive business practice. TI is not responsible or liable for any such statements.

TI products are not authorized for use in safety-critical applications (such as life support) where a failure of the TI product would reasonably be expected to cause severe personal injury or death, unless officers of the parties have executed an agreement specifically governing such use. Buyers represent that they have all necessary expertise in the safety and regulatory ramifications of their applications, and acknowledge and agree that they are solely responsible for all legal, regulatory and safety-related requirements concerning their products and any use of TI products in such safety-critical applications, notwithstanding any applications-related information or support that may be provided by TI. Further, Buyers must fully indemnify TI and its representatives against any damages arising out of the use of TI products in such safety-critical applications.

TI products are neither designed nor intended for use in military/aerospace applications or environments unless the TI products are specifically designated by TI as military-grade or "enhanced plastic." Only products designated by TI as military-grade meet military specifications. Buyers acknowledge and agree that any such use of TI products which TI has not designated as military-grade is solely at the Buyer's risk, and that they are solely responsible for compliance with all legal and regulatory requirements in connection with such use.

TI products are neither designed nor intended for use in automotive applications or environments unless the specific TI products are designated by TI as compliant with ISO/TS 16949 requirements. Buyers acknowledge and agree that, if they use any non-designated products in automotive applications, TI will not be responsible for any failure to meet such requirements.

Following are URLs where you can obtain information on other Texas Instruments products and application solutions:

### Products

Amplifiers	<a href="http://amplifier.ti.com">amplifier.ti.com</a>
Data Converters	<a href="http://dataconverter.ti.com">dataconverter.ti.com</a>
DSP	<a href="http://dsp.ti.com">dsp.ti.com</a>
Clocks and Timers	<a href="http://www.ti.com/clocks">www.ti.com/clocks</a>
Interface	<a href="http://interface.ti.com">interface.ti.com</a>
Logic	<a href="http://logic.ti.com">logic.ti.com</a>
Power Mgmt	<a href="http://power.ti.com">power.ti.com</a>
Microcontrollers	<a href="http://microcontroller.ti.com">microcontroller.ti.com</a>
RFID	<a href="http://www.ti-rfid.com">www.ti-rfid.com</a>
RF/IF and ZigBee® Solutions	<a href="http://www.ti.com/lprf">www.ti.com/lprf</a>

### Applications

Audio	<a href="http://www.ti.com/audio">www.ti.com/audio</a>
Automotive	<a href="http://www.ti.com/automotive">www.ti.com/automotive</a>
Broadband	<a href="http://www.ti.com/broadband">www.ti.com/broadband</a>
Digital Control	<a href="http://www.ti.com/digitalcontrol">www.ti.com/digitalcontrol</a>
Medical	<a href="http://www.ti.com/medical">www.ti.com/medical</a>
Military	<a href="http://www.ti.com/military">www.ti.com/military</a>
Optical Networking	<a href="http://www.ti.com/opticalnetwork">www.ti.com/opticalnetwork</a>
Security	<a href="http://www.ti.com/security">www.ti.com/security</a>
Telephony	<a href="http://www.ti.com/telephony">www.ti.com/telephony</a>
Video & Imaging	<a href="http://www.ti.com/video">www.ti.com/video</a>
Wireless	<a href="http://www.ti.com/wireless">www.ti.com/wireless</a>

Mailing Address: Texas Instruments, Post Office Box 655303, Dallas, Texas 75265  
Copyright © 2008, Texas Instruments Incorporated