

SN54LV240A, SN74LV240A OCTAL BUFFERS/DRIVERS WITH 3-STATE OUTPUTS

SCLS384H – SEPTEMBER 1997 – REVISED APRIL 2005

- 2-V to 5.5-V V_{CC} Operation
- Max t_{pd} of 6.5 ns at 5 V
- Typical V_{OLP} (Output Ground Bounce)
<0.8 V at $V_{CC} = 3.3$ V, $T_A = 25^\circ\text{C}$
- Typical V_{OHV} (Output V_{OH} Undershoot)
>2.3 V at $V_{CC} = 3.3$ V, $T_A = 25^\circ\text{C}$
- Support Mixed-Mode Voltage Operation on All Ports
- Latch-Up Performance Exceeds 250 mA Per JESD 17
- ESD Protection Exceeds JESD 22
 - 2000-V Human-Body Model (A114-A)
 - 200-V Machine Model (A115-A)
 - 1000-V Charged-Device Model (C101)

SN54LV240A . . . J OR W PACKAGE
SN74LV240A . . . DB, DGV, DW, NS, OR PW PACKAGE
(TOP VIEW)

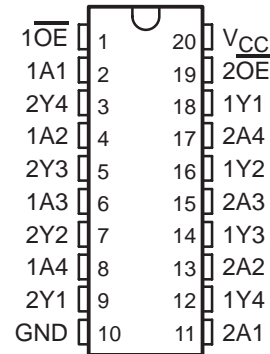

SN54LV240A . . . FK PACKAGE
(TOP VIEW)

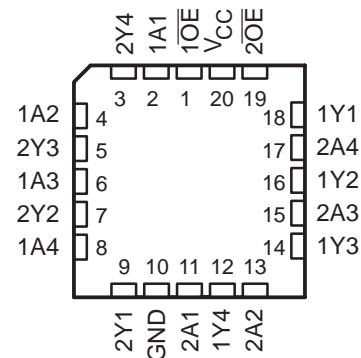

description/ordering information

These octal buffers/drivers are designed for 2-V to 5.5-V V_{CC} operation.

The 'LV240A devices are designed specifically to improve both the performance and density of 3-state memory address drivers, clock drivers, and bus-oriented receivers and transmitters.

These devices are organized as two 4-bit buffers/line drivers with separate output-enable (\overline{OE}) inputs. When \overline{OE} is low, the device passes data from the A inputs to the Y outputs. When \overline{OE} is high, the outputs are in the high-impedance state.

ORDERING INFORMATION

T_A	PACKAGE†		ORDERABLE PART NUMBER	TOP-SIDE MARKING
-40°C to 85°C	SOIC – DW	Tube of 25	SN74LV240ADW	LV240A
		Reel of 2000	SN74LV240ADWR	
	SOP – NS	Reel of 2000	SN74LV240ANSR	74LV240A
	SSOP – DB	Reel of 2000	SN74LV240ADBR	LV240A
	TSSOP – PW	Tube of 70	SN74LV240APW	LV240A
		Reel of 2000	SN74LV240APWR	
Reel of 250		SN74LV240APWT		
TVSOP – DGV	Reel of 2000	SN74LV240ADGVR	LV240A	
-55°C to 125°C	CDIP – J	Tube of 20	SNJ54LV240AJ	SNJ54LV240AJ
	CFP – W	Tube of 85	SNJ54LV240AW	SNJ54LV240AW
	LCCC – FK	Tube of 55	SNJ54LV240AFK	SNJ54LV240AFK

† Package drawings, standard packing quantities, thermal data, symbolization, and PCB design guidelines are available at www.ti.com/sc/package.



Please be aware that an important notice concerning availability, standard warranty, and use in critical applications of Texas Instruments semiconductor products and disclaimers thereto appears at the end of this data sheet.

UNLESS OTHERWISE NOTED this document contains PRODUCTION DATA information current as of publication date. Products conform to specifications per the terms of Texas Instruments standard warranty. Production processing does not necessarily include testing of all parameters.

 **TEXAS
INSTRUMENTS**

POST OFFICE BOX 655303 • DALLAS, TEXAS 75265

Copyright © 2005, Texas Instruments Incorporated

SN54LV240A, SN74LV240A OCTAL BUFFERS/DRIVERS WITH 3-STATE OUTPUTS

SCLS384H – SEPTEMBER 1997 – REVISED APRIL 2005

description/ordering information (continued)

To ensure the high-impedance state during power up or power down, \overline{OE} should be tied to V_{CC} through a pullup resistor; the minimum value of the resistor is determined by the current-sinking capability of the driver.

FUNCTION TABLE
(each buffer)

INPUTS		OUTPUT
\overline{OE}	A	Y
L	H	L
L	L	H
H	X	Z

logic diagram (positive logic)

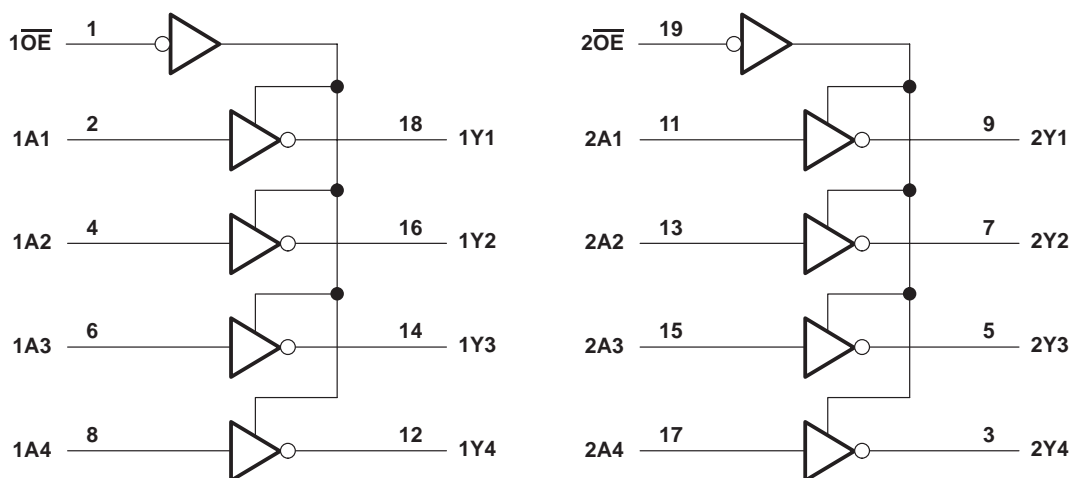

SN54LV240A, SN74LV240A OCTAL BUFFERS/DRIVERS WITH 3-STATE OUTPUTS

SCLS384H – SEPTEMBER 1997 – REVISED APRIL 2005

recommended operating conditions (see Note 4)

		SN54LV240A		SN74LV240A		UNIT	
		MIN	MAX	MIN	MAX		
V_{CC}	Supply voltage	2	5.5	2	5.5	V	
V_{IH}	High-level input voltage	$V_{CC} = 2\text{ V}$	1.5	1.5		V	
		$V_{CC} = 2.3\text{ V to }2.7\text{ V}$	$V_{CC} \times 0.7$	$V_{CC} \times 0.7$			
		$V_{CC} = 3\text{ V to }3.6\text{ V}$	$V_{CC} \times 0.7$	$V_{CC} \times 0.7$			
		$V_{CC} = 4.5\text{ V to }5.5\text{ V}$	$V_{CC} \times 0.7$	$V_{CC} \times 0.7$			
V_{IL}	Low-level input voltage	$V_{CC} = 2\text{ V}$	0.5		0.5	V	
		$V_{CC} = 2.3\text{ V to }2.7\text{ V}$	$V_{CC} \times 0.3$		$V_{CC} \times 0.3$		
		$V_{CC} = 3\text{ V to }3.6\text{ V}$	$V_{CC} \times 0.3$		$V_{CC} \times 0.3$		
		$V_{CC} = 4.5\text{ V to }5.5\text{ V}$	$V_{CC} \times 0.3$		$V_{CC} \times 0.3$		
V_I	Input voltage	0	5.5	0	5.5	V	
V_O	Output voltage	High or low state	0	V_{CC}	0	V_{CC}	V
		3-state	0	5.5	0	5.5	V
I_{OH}	High-level output current	$V_{CC} = 2\text{ V}$	-50		-50	μA	
		$V_{CC} = 2.3\text{ V to }2.7\text{ V}$	-2		-2	mA	
		$V_{CC} = 3\text{ V to }3.6\text{ V}$	-8		-8		
		$V_{CC} = 4.5\text{ V to }5.5\text{ V}$	-16		-16		
I_{OL}	Low-level output current	$V_{CC} = 2\text{ V}$	50		50	μA	
		$V_{CC} = 2.3\text{ V to }2.7\text{ V}$	2		2	mA	
		$V_{CC} = 3\text{ V to }3.6\text{ V}$	8		8		
		$V_{CC} = 4.5\text{ V to }5.5\text{ V}$	16		16		
$\Delta t/\Delta v$	Input transition rise or fall rate	$V_{CC} = 2.3\text{ V to }2.7\text{ V}$	200		200	ns/V	
		$V_{CC} = 3\text{ V to }3.6\text{ V}$	100		100		
		$V_{CC} = 4.5\text{ V to }5.5\text{ V}$	20		20		
T_A	Operating free-air temperature	-55	125	-40	85	$^{\circ}\text{C}$	

NOTE 4: All unused inputs of the device must be held at V_{CC} or GND to ensure proper device operation. Refer to the TI application report, *Implications of Slow or Floating CMOS Inputs*, literature number SCBA004.

electrical characteristics over recommended operating free-air temperature range (unless otherwise noted)

PARAMETER	TEST CONDITIONS	V_{CC}	SN54LV240A			SN74LV240A			UNIT
			MIN	TYP	MAX	MIN	TYP	MAX	
V_{OH}	$I_{OH} = -50\ \mu\text{A}$	2 V to 5.5 V	$V_{CC}-0.1$		$V_{CC}-0.1$			V	
	$I_{OH} = -2\ \text{mA}$	2.3 V	2		2				
	$I_{OH} = -8\ \text{mA}$	3 V	2.48		2.48				
	$I_{OH} = -16\ \text{mA}$	4.5 V	3.8		3.8				
V_{OL}	$I_{OL} = 50\ \mu\text{A}$	2 V to 5.5 V			0.1			V	
	$I_{OL} = 2\ \text{mA}$	2.3 V			0.4				
	$I_{OL} = 8\ \text{mA}$	3 V			0.44				
	$I_{OL} = 16\ \text{mA}$	4.5 V			0.55				
I_I	$V_I = 5.5\text{ V or GND}$	0 to 5.5 V			± 1			μA	
I_{OZ}	$V_O = V_{CC}\text{ or GND}$	5.5 V			± 5			μA	
I_{CC}	$V_I = V_{CC}\text{ or GND, } I_O = 0$	5.5 V			20			μA	
I_{off}	$V_I\text{ or }V_O = 0\text{ to }5.5\text{ V}$	0			5			μA	
C_i	$V_I = V_{CC}\text{ or GND}$	3.3 V	2.3		2.3			pF	

PRODUCT PREVIEW information concerns products in the formative or design phase of development. Characteristic data and other specifications are design goals. Texas Instruments reserves the right to change or discontinue these products without notice.



POST OFFICE BOX 655303 • DALLAS, TEXAS 75265

SN54LV240A, SN74LV240A OCTAL BUFFERS/DRIVERS WITH 3-STATE OUTPUTS

SCLS384H – SEPTEMBER 1997 – REVISED APRIL 2005

switching characteristics over recommended operating free-air temperature range, $V_{CC} = 2.5\text{ V} \pm 0.2\text{ V}$ (unless otherwise noted) (see Figure 1)

PARAMETER	FROM (INPUT)	TO (OUTPUT)	LOAD CAPACITANCE	$T_A = 25^\circ\text{C}$			SN54LV240A		SN74LV240A		UNIT
				MIN	TYP	MAX	MIN	MAX	MIN	MAX	
t_{pd}	A	Y	$C_L = 15\text{ pF}$	6.3*	11.6*		1*	14*	1	14	ns
t_{en}	\overline{OE}	Y		8.5*	14.6*		1*	17*	1	17	
t_{dis}	\overline{OE}	Y		9.7*	14.1*		1*	16*	1	16	
t_{pd}	A	Y	$C_L = 50\text{ pF}$	8.2	14.4		1	17	1	17	ns
t_{en}	\overline{OE}	Y		10.3	17.8		1	21	1	21	
t_{dis}	\overline{OE}	Y		14.2	19.2		1	21	1	21	
$t_{sk(o)}$						2				2	

* On products compliant to MIL-PRF-38535, this parameter is not production tested.

switching characteristics over recommended operating free-air temperature range, $V_{CC} = 3.3\text{ V} \pm 0.3\text{ V}$ (unless otherwise noted) (see Figure 1)

PARAMETER	FROM (INPUT)	TO (OUTPUT)	LOAD CAPACITANCE	$T_A = 25^\circ\text{C}$			SN54LV240A		SN74LV240A		UNIT
				MIN	TYP	MAX	MIN	MAX	MIN	MAX	
t_{pd}	A	Y	$C_L = 15\text{ pF}$	4.6*	7.5*		1*	9*	1	9	ns
t_{en}	\overline{OE}	Y		6.2*	10.6*		1*	12.5*	1	12.5	
t_{dis}	\overline{OE}	Y		8.3*	12.5*		1*	13.5*	1	13.5	
t_{pd}	A	Y	$C_L = 50\text{ pF}$	5.9	11		1	12.5	1	12.5	ns
t_{en}	\overline{OE}	Y		7.5	14.1		1	16	1	16	
t_{dis}	\overline{OE}	Y		11.8	15		1	17	1	17	
$t_{sk(o)}$						1.5				1.5	

* On products compliant to MIL-PRF-38535, this parameter is not production tested.

switching characteristics over recommended operating free-air temperature range, $V_{CC} = 5\text{ V} \pm 0.5\text{ V}$ (unless otherwise noted) (see Figure 1)

PARAMETER	FROM (INPUT)	TO (OUTPUT)	LOAD CAPACITANCE	$T_A = 25^\circ\text{C}$			SN54LV240A		SN74LV240A		UNIT
				MIN	TYP	MAX	MIN	MAX	MIN	MAX	
t_{pd}	A	Y	$C_L = 15\text{ pF}$	3.4*	5.5*		1*	6.5*	1	6.5	ns
t_{en}	\overline{OE}	Y		4.6*	7.3*		1*	8.5*	1	8.5	
t_{dis}	\overline{OE}	Y		7.4*	12.2*		1*	13.5*	1	13.5	
t_{pd}	A	Y	$C_L = 50\text{ pF}$	4.4	7.5		1	8.5	1	8.5	ns
t_{en}	\overline{OE}	Y		5.6	9.3		1	10.5	1	10.5	
t_{dis}	\overline{OE}	Y		9.7	14.2		1	15.5	1	15.5	
$t_{sk(o)}$						1				1	

* On products compliant to MIL-PRF-38535, this parameter is not production tested.

PRODUCT PREVIEW information concerns products in the formative or design phase of development. Characteristic data and other specifications are design goals. Texas Instruments reserves the right to change or discontinue these products without notice.



POST OFFICE BOX 655303 • DALLAS, TEXAS 75265

SN54LV240A, SN74LV240A
OCTAL BUFFERS/DRIVERS
WITH 3-STATE OUTPUTS

SCLS384H – SEPTEMBER 1997 – REVISED APRIL 2005

noise characteristics, $V_{CC} = 3.3\text{ V}$, $C_L = 50\text{ pF}$, $T_A = 25^\circ\text{C}$ (see Note 5)

PARAMETER	SN74LV240A			UNIT
	MIN	TYP	MAX	
$V_{OL(P)}$ Quiet output, maximum dynamic V_{OL}		0.56		V
$V_{OL(V)}$ Quiet output, minimum dynamic V_{OL}		-0.49		V
$V_{OH(V)}$ Quiet output, minimum dynamic V_{OH}		2.82		V
$V_{IH(D)}$ High-level dynamic input voltage	2.31			V
$V_{IL(D)}$ Low-level dynamic input voltage			0.99	V

NOTE 5: Characteristics are for surface-mount packages only.

operating characteristics, $T_A = 25^\circ\text{C}$

PARAMETER	TEST CONDITIONS	V_{CC}	TYP	UNIT
C_{pd} Power dissipation capacitance	$C_L = 50\text{ pF}$, $f = 10\text{ MHz}$	3.3 V	14	pF
		5 V	16.4	



PARAMETER MEASUREMENT INFORMATION

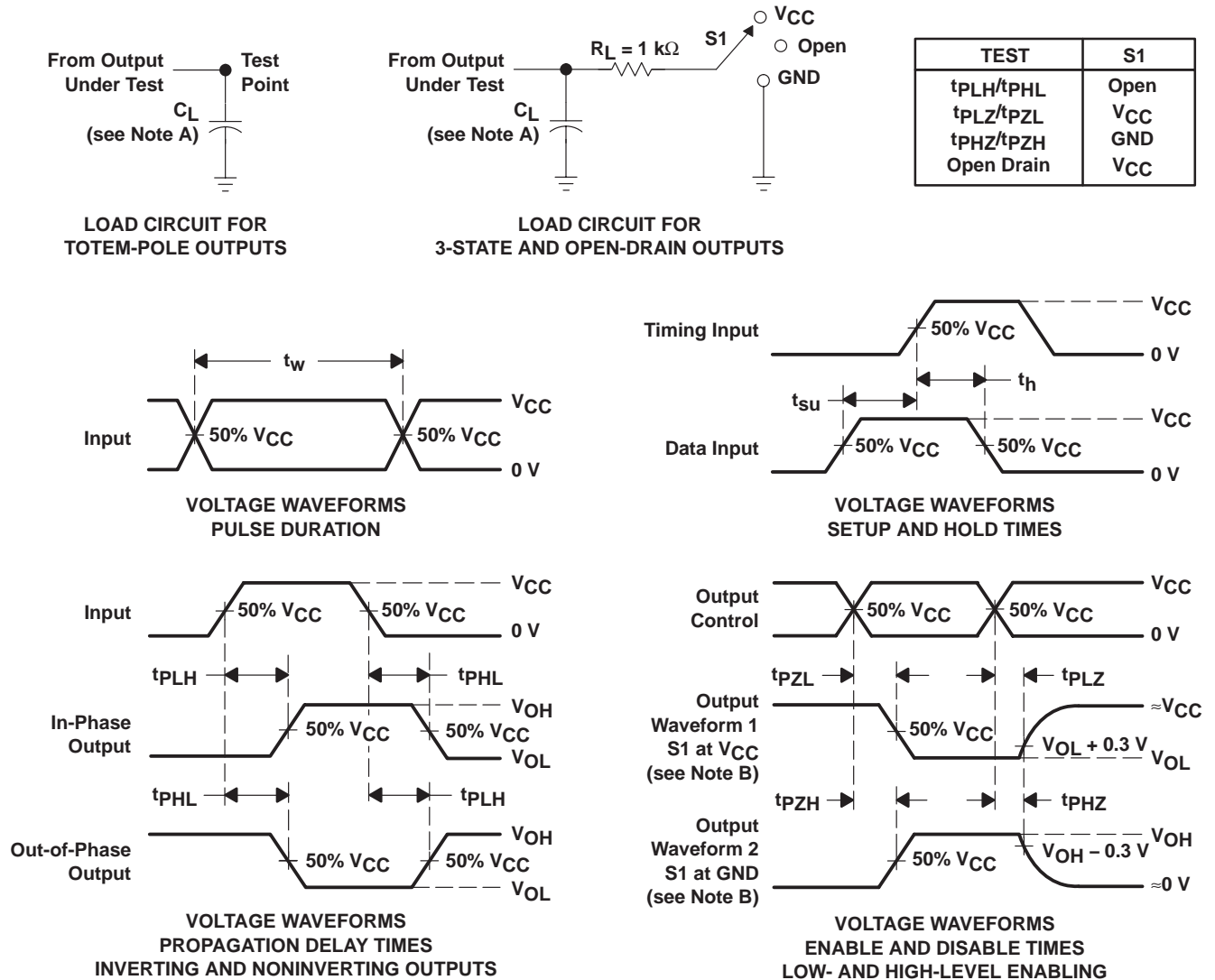

- NOTES:
- A. C_L includes probe and jig capacitance.
 - B. Waveform 1 is for an output with internal conditions such that the output is low, except when disabled by the output control. Waveform 2 is for an output with internal conditions such that the output is high, except when disabled by the output control.
 - C. All input pulses are supplied by generators having the following characteristics: $PRR \leq 1\text{ MHz}$, $Z_O = 50\ \Omega$, $t_r \leq 3\text{ ns}$, $t_f \leq 3\text{ ns}$.
 - D. The outputs are measured one at a time, with one input transition per measurement.
 - E. t_{PLZ} and t_{PHZ} are the same as t_{dis} .
 - F. t_{PZL} and t_{PZH} are the same as t_{en} .
 - G. t_{PHL} and t_{PLH} are the same as t_{pd} .
 - H. All parameters and waveforms are not applicable to all devices.

Figure 1. Load Circuit and Voltage Waveforms

PACKAGING INFORMATION

Orderable Device	Status ⁽¹⁾	Package Type	Package Drawing	Pins	Package Qty	Eco Plan ⁽²⁾	Lead/Ball Finish	MSL Peak Temp ⁽³⁾
SN74LV240ADBLE	OBSOLETE	SSOP	DB	20		TBD	Call TI	Call TI
SN74LV240ADBR	ACTIVE	SSOP	DB	20	2000	Green (RoHS & no Sb/Br)	CU NIPDAU	Level-1-260C-UNLIM
SN74LV240ADBRE4	ACTIVE	SSOP	DB	20	2000	Green (RoHS & no Sb/Br)	CU NIPDAU	Level-1-260C-UNLIM
SN74LV240ADBRG4	ACTIVE	SSOP	DB	20	2000	Green (RoHS & no Sb/Br)	CU NIPDAU	Level-1-260C-UNLIM
SN74LV240ADGVR	ACTIVE	TVSOP	DGV	20	2000	Green (RoHS & no Sb/Br)	CU NIPDAU	Level-1-260C-UNLIM
SN74LV240ADGVRE4	ACTIVE	TVSOP	DGV	20	2000	Green (RoHS & no Sb/Br)	CU NIPDAU	Level-1-260C-UNLIM
SN74LV240ADGVRG4	ACTIVE	TVSOP	DGV	20	2000	Green (RoHS & no Sb/Br)	CU NIPDAU	Level-1-260C-UNLIM
SN74LV240ADW	ACTIVE	SOIC	DW	20	25	Green (RoHS & no Sb/Br)	CU NIPDAU	Level-1-260C-UNLIM
SN74LV240ADWE4	ACTIVE	SOIC	DW	20	25	Green (RoHS & no Sb/Br)	CU NIPDAU	Level-1-260C-UNLIM
SN74LV240ADWG4	ACTIVE	SOIC	DW	20	25	Green (RoHS & no Sb/Br)	CU NIPDAU	Level-1-260C-UNLIM
SN74LV240ADWR	ACTIVE	SOIC	DW	20	2000	Green (RoHS & no Sb/Br)	CU NIPDAU	Level-1-260C-UNLIM
SN74LV240ADWRE4	ACTIVE	SOIC	DW	20	2000	Green (RoHS & no Sb/Br)	CU NIPDAU	Level-1-260C-UNLIM
SN74LV240ADWRG4	ACTIVE	SOIC	DW	20	2000	Green (RoHS & no Sb/Br)	CU NIPDAU	Level-1-260C-UNLIM
SN74LV240ANSR	ACTIVE	SO	NS	20	2000	Green (RoHS & no Sb/Br)	CU NIPDAU	Level-1-260C-UNLIM
SN74LV240ANSRE4	ACTIVE	SO	NS	20	2000	Green (RoHS & no Sb/Br)	CU NIPDAU	Level-1-260C-UNLIM
SN74LV240ANSRG4	ACTIVE	SO	NS	20	2000	Green (RoHS & no Sb/Br)	CU NIPDAU	Level-1-260C-UNLIM
SN74LV240APW	ACTIVE	TSSOP	PW	20	70	Green (RoHS & no Sb/Br)	CU NIPDAU	Level-1-260C-UNLIM
SN74LV240APWE4	ACTIVE	TSSOP	PW	20	70	Green (RoHS & no Sb/Br)	CU NIPDAU	Level-1-260C-UNLIM
SN74LV240APWG4	ACTIVE	TSSOP	PW	20	70	Green (RoHS & no Sb/Br)	CU NIPDAU	Level-1-260C-UNLIM
SN74LV240APWLE	OBSOLETE	TSSOP	PW	20		TBD	Call TI	Call TI
SN74LV240APWR	ACTIVE	TSSOP	PW	20	2000	Green (RoHS & no Sb/Br)	CU NIPDAU	Level-1-260C-UNLIM
SN74LV240APWRE4	ACTIVE	TSSOP	PW	20	2000	Green (RoHS & no Sb/Br)	CU NIPDAU	Level-1-260C-UNLIM
SN74LV240APWRG4	ACTIVE	TSSOP	PW	20	2000	Green (RoHS & no Sb/Br)	CU NIPDAU	Level-1-260C-UNLIM
SN74LV240APWT	ACTIVE	TSSOP	PW	20	250	Green (RoHS & no Sb/Br)	CU NIPDAU	Level-1-260C-UNLIM
SN74LV240APWTE4	ACTIVE	TSSOP	PW	20	250	Green (RoHS & no Sb/Br)	CU NIPDAU	Level-1-260C-UNLIM
SN74LV240APWTG4	ACTIVE	TSSOP	PW	20	250	Green (RoHS & no Sb/Br)	CU NIPDAU	Level-1-260C-UNLIM

Orderable Device	Status ⁽¹⁾	Package Type	Package Drawing	Pins	Package Qty	Eco Plan ⁽²⁾	Lead/Ball Finish	MSL Peak Temp ⁽³⁾
no Sb/Br)								

⁽¹⁾ The marketing status values are defined as follows:

ACTIVE: Product device recommended for new designs.

LIFEBUY: TI has announced that the device will be discontinued, and a lifetime-buy period is in effect.

NRND: Not recommended for new designs. Device is in production to support existing customers, but TI does not recommend using this part in a new design.

PREVIEW: Device has been announced but is not in production. Samples may or may not be available.

OBSOLETE: TI has discontinued the production of the device.

⁽²⁾ Eco Plan - The planned eco-friendly classification: Pb-Free (RoHS), Pb-Free (RoHS Exempt), or Green (RoHS & no Sb/Br) - please check <http://www.ti.com/productcontent> for the latest availability information and additional product content details.

TBD: The Pb-Free/Green conversion plan has not been defined.

Pb-Free (RoHS): TI's terms "Lead-Free" or "Pb-Free" mean semiconductor products that are compatible with the current RoHS requirements for all 6 substances, including the requirement that lead not exceed 0.1% by weight in homogeneous materials. Where designed to be soldered at high temperatures, TI Pb-Free products are suitable for use in specified lead-free processes.

Pb-Free (RoHS Exempt): This component has a RoHS exemption for either 1) lead-based flip-chip solder bumps used between the die and package, or 2) lead-based die adhesive used between the die and leadframe. The component is otherwise considered Pb-Free (RoHS compatible) as defined above.

Green (RoHS & no Sb/Br): TI defines "Green" to mean Pb-Free (RoHS compatible), and free of Bromine (Br) and Antimony (Sb) based flame retardants (Br or Sb do not exceed 0.1% by weight in homogeneous material)

⁽³⁾ MSL, Peak Temp. -- The Moisture Sensitivity Level rating according to the JEDEC industry standard classifications, and peak solder temperature.

Important Information and Disclaimer:The information provided on this page represents TI's knowledge and belief as of the date that it is provided. TI bases its knowledge and belief on information provided by third parties, and makes no representation or warranty as to the accuracy of such information. Efforts are underway to better integrate information from third parties. TI has taken and continues to take reasonable steps to provide representative and accurate information but may not have conducted destructive testing or chemical analysis on incoming materials and chemicals. TI and TI suppliers consider certain information to be proprietary, and thus CAS numbers and other limited information may not be available for release.

In no event shall TI's liability arising out of such information exceed the total purchase price of the TI part(s) at issue in this document sold by TI to Customer on an annual basis.

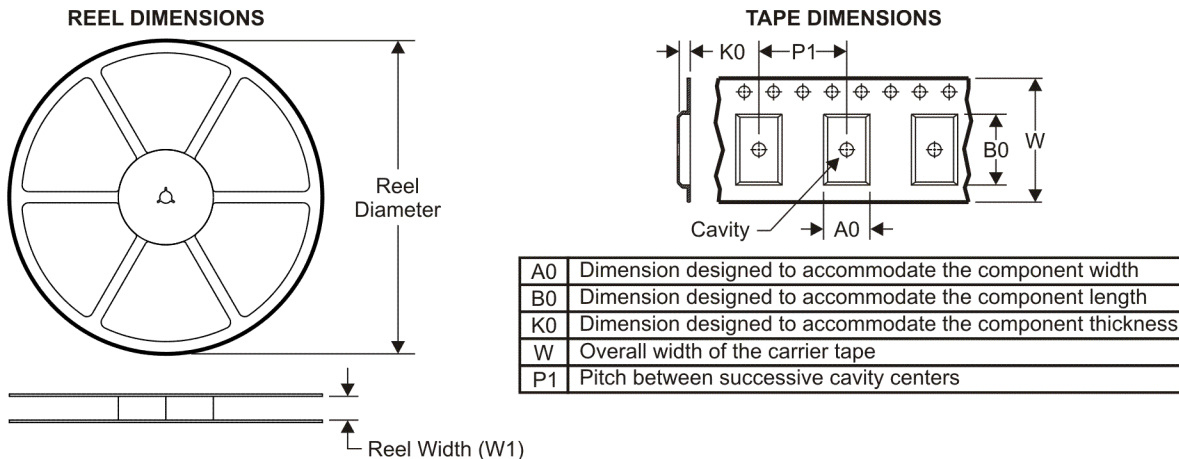
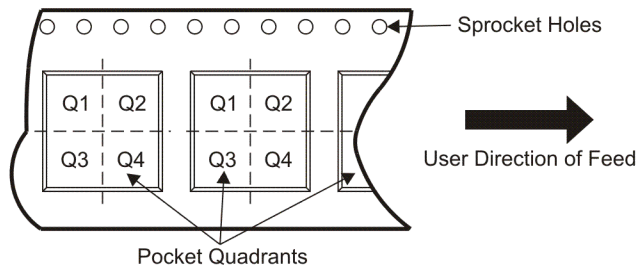
TAPE AND REEL INFORMATION

QUADRANT ASSIGNMENTS FOR PIN 1 ORIENTATION IN TAPE

*All dimensions are nominal

Device	Package Type	Package Drawing	Pins	SPQ	Reel Diameter (mm)	Reel Width W1 (mm)	A0 (mm)	B0 (mm)	K0 (mm)	P1 (mm)	W (mm)	Pin1 Quadrant
SN74LV240ADBR	SSOP	DB	20	2000	330.0	16.4	8.2	7.5	2.5	12.0	16.0	Q1
SN74LV240ADGVR	TVSOP	DGV	20	2000	330.0	12.4	6.9	5.6	1.6	8.0	12.0	Q1
SN74LV240ADWR	SOIC	DW	20	2000	330.0	24.4	10.8	13.0	2.7	12.0	24.0	Q1
SN74LV240ANSR	SO	NS	20	2000	330.0	24.4	8.2	13.0	2.5	12.0	24.0	Q1
SN74LV240APWR	TSSOP	PW	20	2000	330.0	16.4	6.95	7.1	1.6	8.0	16.0	Q1
SN74LV240APWR	TSSOP	PW	20	2000	330.0	16.4	6.95	7.1	1.6	8.0	16.0	Q1
SN74LV240APWT	TSSOP	PW	20	250	330.0	16.4	6.95	7.1	1.6	8.0	16.0	Q1

TAPE AND REEL BOX DIMENSIONS

*All dimensions are nominal

Device	Package Type	Package Drawing	Pins	SPQ	Length (mm)	Width (mm)	Height (mm)
SN74LV240ADBR	SSOP	DB	20	2000	346.0	346.0	33.0
SN74LV240ADGVR	TVSOP	DGV	20	2000	346.0	346.0	29.0
SN74LV240ADWR	SOIC	DW	20	2000	346.0	346.0	41.0
SN74LV240ANSR	SO	NS	20	2000	346.0	346.0	41.0
SN74LV240APWR	TSSOP	PW	20	2000	346.0	346.0	33.0
SN74LV240APWR	TSSOP	PW	20	2000	364.0	364.0	27.0
SN74LV240APWT	TSSOP	PW	20	250	346.0	346.0	33.0

DGV (R-PDSO-G**)

PLASTIC SMALL-OUTLINE

24 PINS SHOWN



4073251/E 08/00

- NOTES: A. All linear dimensions are in millimeters.
 B. This drawing is subject to change without notice.
 C. Body dimensions do not include mold flash or protrusion, not to exceed 0,15 per side.
 D. Falls within JEDEC: 24/48 Pins – MO-153
 14/16/20/56 Pins – MO-194

DW (R-PDSO-G20)

PLASTIC SMALL OUTLINE



- NOTES:
- A. All linear dimensions are in inches (millimeters). Dimensioning and tolerancing per ASME Y14.5M-1994.
 - B. This drawing is subject to change without notice.
 - C. Body dimensions do not include mold flash or protrusion not to exceed 0.006 (0,15).
 - D. Falls within JEDEC MS-013 variation AC.

DW (R-PDSO-G20)

PLASTIC SMALL OUTLINE

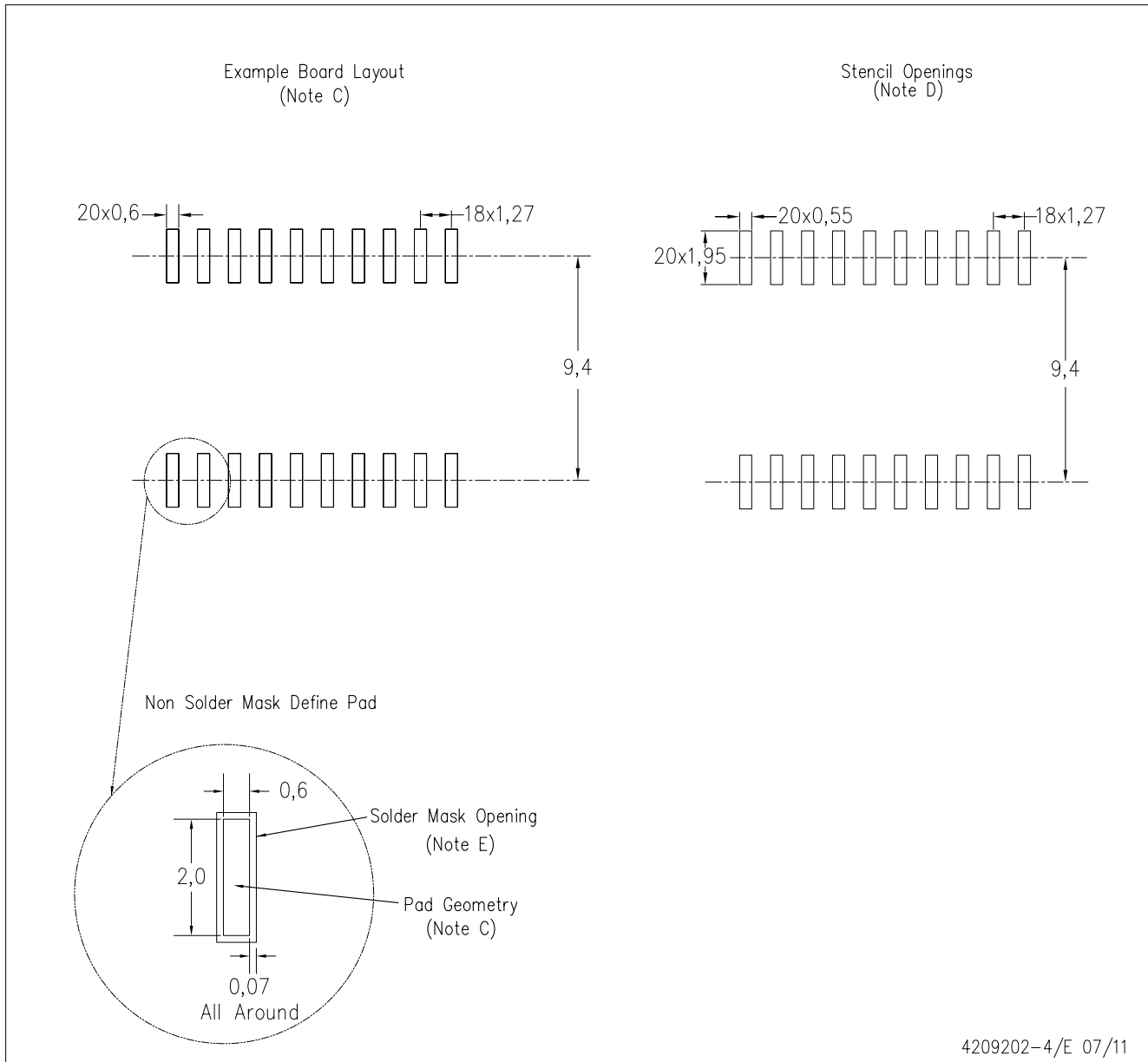

4209202-4/E 07/11

- NOTES:
- A. All linear dimensions are in millimeters.
 - B. This drawing is subject to change without notice.
 - C. Refer to IPC7351 for alternate board design.
 - D. Laser cutting apertures with trapezoidal walls and also rounding corners will offer better paste release. Customers should contact their board assembly site for stencil design recommendations. Refer to IPC-7525
 - E. Customers should contact their board fabrication site for solder mask tolerances between and around signal pads.

PW (R-PDSO-G20)

PLASTIC SMALL OUTLINE



4040064-5/G 02/11

- NOTES:
- A. All linear dimensions are in millimeters. Dimensioning and tolerancing per ASME Y14.5M-1994.
 - B. This drawing is subject to change without notice.
 - C. Body length does not include mold flash, protrusions, or gate burrs. Mold flash, protrusions, or gate burrs shall not exceed 0,15 each side.
 - D. Body width does not include interlead flash. Interlead flash shall not exceed 0,25 each side.
 - E. Falls within JEDEC MO-153

MECHANICAL DATA

NS (R-PDSO-G**)

PLASTIC SMALL-OUTLINE PACKAGE

14-PINS SHOWN



- NOTES:
- A. All linear dimensions are in millimeters.
 - B. This drawing is subject to change without notice.
 - C. Body dimensions do not include mold flash or protrusion, not to exceed 0,15.

DB (R-PDSO-G**)

PLASTIC SMALL-OUTLINE

28 PINS SHOWN



- NOTES: A. All linear dimensions are in millimeters.
 B. This drawing is subject to change without notice.
 C. Body dimensions do not include mold flash or protrusion not to exceed 0,15.
 D. Falls within JEDEC MO-150

4040065 /E 12/01

IMPORTANT NOTICE

Texas Instruments Incorporated and its subsidiaries (TI) reserve the right to make corrections, modifications, enhancements, improvements, and other changes to its products and services at any time and to discontinue any product or service without notice. Customers should obtain the latest relevant information before placing orders and should verify that such information is current and complete. All products are sold subject to TI's terms and conditions of sale supplied at the time of order acknowledgment.

TI warrants performance of its hardware products to the specifications applicable at the time of sale in accordance with TI's standard warranty. Testing and other quality control techniques are used to the extent TI deems necessary to support this warranty. Except where mandated by government requirements, testing of all parameters of each product is not necessarily performed.

TI assumes no liability for applications assistance or customer product design. Customers are responsible for their products and applications using TI components. To minimize the risks associated with customer products and applications, customers should provide adequate design and operating safeguards.

TI does not warrant or represent that any license, either express or implied, is granted under any TI patent right, copyright, mask work right, or other TI intellectual property right relating to any combination, machine, or process in which TI products or services are used. Information published by TI regarding third-party products or services does not constitute a license from TI to use such products or services or a warranty or endorsement thereof. Use of such information may require a license from a third party under the patents or other intellectual property of the third party, or a license from TI under the patents or other intellectual property of TI.

Reproduction of TI information in TI data books or data sheets is permissible only if reproduction is without alteration and is accompanied by all associated warranties, conditions, limitations, and notices. Reproduction of this information with alteration is an unfair and deceptive business practice. TI is not responsible or liable for such altered documentation. Information of third parties may be subject to additional restrictions.

Resale of TI products or services with statements different from or beyond the parameters stated by TI for that product or service voids all express and any implied warranties for the associated TI product or service and is an unfair and deceptive business practice. TI is not responsible or liable for any such statements.

TI products are not authorized for use in safety-critical applications (such as life support) where a failure of the TI product would reasonably be expected to cause severe personal injury or death, unless officers of the parties have executed an agreement specifically governing such use. Buyers represent that they have all necessary expertise in the safety and regulatory ramifications of their applications, and acknowledge and agree that they are solely responsible for all legal, regulatory and safety-related requirements concerning their products and any use of TI products in such safety-critical applications, notwithstanding any applications-related information or support that may be provided by TI. Further, Buyers must fully indemnify TI and its representatives against any damages arising out of the use of TI products in such safety-critical applications.

TI products are neither designed nor intended for use in military/aerospace applications or environments unless the TI products are specifically designated by TI as military-grade or "enhanced plastic." Only products designated by TI as military-grade meet military specifications. Buyers acknowledge and agree that any such use of TI products which TI has not designated as military-grade is solely at the Buyer's risk, and that they are solely responsible for compliance with all legal and regulatory requirements in connection with such use.

TI products are neither designed nor intended for use in automotive applications or environments unless the specific TI products are designated by TI as compliant with ISO/TS 16949 requirements. Buyers acknowledge and agree that, if they use any non-designated products in automotive applications, TI will not be responsible for any failure to meet such requirements.

Following are URLs where you can obtain information on other Texas Instruments products and application solutions:

Products

Audio	www.ti.com/audio
Amplifiers	amplifier.ti.com
Data Converters	dataconverter.ti.com
DLP® Products	www.dlp.com
DSP	dsp.ti.com
Clocks and Timers	www.ti.com/clocks
Interface	interface.ti.com
Logic	logic.ti.com
Power Mgmt	power.ti.com
Microcontrollers	microcontroller.ti.com
RFID	www.ti-rfid.com
RF/IF and ZigBee® Solutions	www.ti.com/lprf

Applications

Communications and Telecom	www.ti.com/communications
Computers and Peripherals	www.ti.com/computers
Consumer Electronics	www.ti.com/consumer-apps
Energy and Lighting	www.ti.com/energy
Industrial	www.ti.com/industrial
Medical	www.ti.com/medical
Security	www.ti.com/security
Space, Avionics and Defense	www.ti.com/space-avionics-defense
Transportation and Automotive	www.ti.com/automotive
Video and Imaging	www.ti.com/video
Wireless	www.ti.com/wireless-apps

TI E2E Community Home Page

e2e.ti.com

Mailing Address: Texas Instruments, Post Office Box 655303, Dallas, Texas 75265
Copyright © 2011, Texas Instruments Incorporated