

# SN74AVCH16T245

## 16-BIT DUAL-SUPPLY BUS TRANSCEIVER WITH CONFIGURABLE VOLTAGE TRANSLATION AND 3-STATE OUTPUTS

SCES587B – AUGUST 2004 – REVISED APRIL 2005

- Control Inputs  $V_{IH}/V_{IL}$  Levels Are Referenced to  $V_{CCA}$  Voltage
- $V_{CC}$  Isolation Feature – If Either  $V_{CC}$  Input Is at GND, Both Ports Are in the High-Impedance State
- Overvoltage-Tolerant Inputs/Outputs Allow Mixed-Voltage-Mode Data Communications
- Fully Configurable Dual-Rail Design Allows Each Port to Operate Over the Full 1.2-V to 3.6-V Power-Supply Range
- $I_{off}$  Supports Partial-Power-Down Mode Operation
- I/Os Are 4.6-V Tolerant
- Bus Hold on Data Inputs Eliminates the Need for External Pullup/Pulldown Resistors
- Latch-Up Performance Exceeds 100 mA Per JESD 78, Class II
- ESD Protection Exceeds JESD 22
  - 8000-V Human-Body Model (A114-A)
  - 200-V Machine Model (A115-A)
  - 1000-V Charged-Device Model (C101)

DGG OR DGV PACKAGE  
(TOP VIEW)

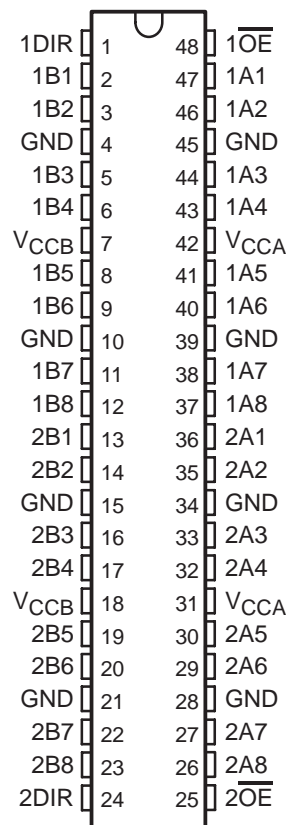

### description/ordering information

This 16-bit noninverting bus transceiver uses two separate configurable power-supply rails. The SN74AVCH16T245 is optimized to operate with  $V_{CCA}/V_{CCB}$  set at 1.4 V to 3.6 V. It is operational with  $V_{CCA}/V_{CCB}$  as low as 1.2 V. The A port is designed to track  $V_{CCA}$ .  $V_{CCA}$  accepts any supply voltage from 1.2 V to 3.6 V. The B port is designed to track  $V_{CCB}$ .  $V_{CCB}$  accepts any supply voltage from 1.2 V to 3.6 V. This allows for universal low-voltage bidirectional translation between any of the 1.2-V, 1.5-V, 1.8-V, 2.5-V, and 3.3-V voltage nodes.

The SN74AVCH16T245 is designed for asynchronous communication between data buses. The device transmits data from the A bus to the B bus or from the B bus to the A bus, depending on the logic level at the direction-control (DIR) input. The output-enable ( $\overline{OE}$ ) input can be used to disable the outputs so the buses are effectively isolated.

The SN74AVCH16T245 is designed so that the control pins (1DIR, 2DIR,  $\overline{1OE}$ , and  $\overline{2OE}$ ) are supplied by  $V_{CCA}$ .

### ORDERING INFORMATION

$T_A$	PACKAGE†		ORDERABLE PART NUMBER	TOP-SIDE MARKING
–40°C to 85°C	TSSOP – DGG	Tape and reel	SN74AVCH16T245GR	AVCH16T245
	TVSOP – DGV	Tape and reel	SN74AVCH16T245VR	WJ245
	VFBGA – GQL	Tape and reel	SN74AVCH16T245KR	WJ245
	VFBGA – ZQL (Pb-free)		74AVCH16T245ZQLR	

† Package drawings, standard packing quantities, thermal data, symbolization, and PCB design guidelines are available at [www.ti.com/sc/package](http://www.ti.com/sc/package).

Please be aware that an important notice concerning availability, standard warranty, and use in critical applications of Texas Instruments semiconductor products and disclaimers thereto appears at the end of this data sheet.



**PRODUCTION DATA** information is current as of publication date. Products conform to specifications per the terms of Texas Instruments standard warranty. Production processing does not necessarily include testing of all parameters.

**TEXAS  
INSTRUMENTS**

POST OFFICE BOX 655303 • DALLAS, TEXAS 75265

Copyright © 2005, Texas Instruments Incorporated

# SN74AVCH16T245

## 16-BIT DUAL-SUPPLY BUS TRANSCEIVER

### WITH CONFIGURABLE VOLTAGE TRANSLATION AND 3-STATE OUTPUTS

SCES587B – AUGUST 2004 – REVISED APRIL 2005

#### description/ordering information (continued)

This device is fully specified for partial-power-down applications using  $I_{off}$ . The  $I_{off}$  circuitry disables the outputs, preventing damaging current backflow through the device when it is powered down.

The  $V_{CC}$  isolation feature ensures that if either  $V_{CC}$  input is at GND, then both ports are in the high-impedance state.

Active bus-hold circuitry holds unused or undriven inputs at a valid logic state. Use of pullup or pulldown resistors with the bus-hold circuitry is not recommended.

To ensure the high-impedance state during power up or power down,  $\overline{OE}$  should be tied to  $V_{CC}$  through a pullup resistor; the minimum value of the resistor is determined by the current-sinking capability of the driver.

#### GQL OR ZQL PACKAGE (TOP VIEW)

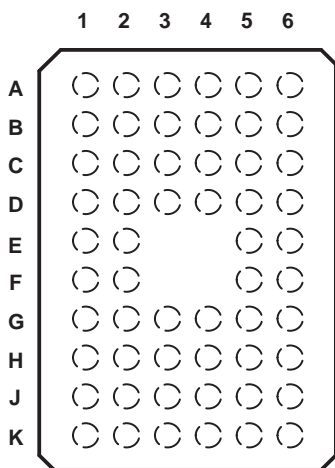

#### terminal assignments

	1	2	3	4	5	6
A	1DIR	NC	NC	NC	NC	$\overline{1OE}$
B	1B2	1B1	GND	GND	1A1	1A2
C	1B4	1B3	$V_{CCB}$	$V_{CCA}$	1A3	1A4
D	1B6	1B5	GND	GND	1A5	1A6
E	1B8	1B7			1A7	1A8
F	2B1	2B2			2A2	2A1
G	2B3	2B4	GND	GND	2A4	2A3
H	2B5	2B6	$V_{CCB}$	$V_{CCA}$	2A6	2A5
J	2B7	2B8	GND	GND	2A8	2A7
K	2DIR	NC	NC	NC	NC	$\overline{2OE}$

NC – No internal connection

#### FUNCTION TABLE (each 8-bit section)

INPUTS		OPERATION
$\overline{OE}$	DIR	
L	L	B data to A bus
L	H	A data to B bus
H	X	Isolation

**SN74AVCH16T245**  
**16-BIT DUAL-SUPPLY BUS TRANSCEIVER**  
**WITH CONFIGURABLE VOLTAGE TRANSLATION AND 3-STATE OUTPUTS**

SCES587B – AUGUST 2004 – REVISED APRIL 2005

**logic diagram (positive logic)**

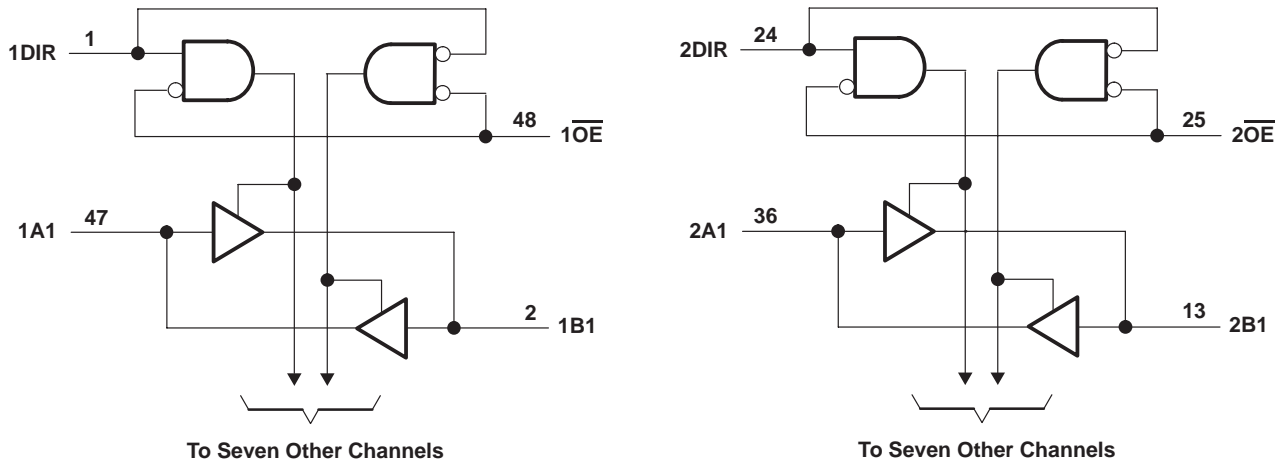

**absolute maximum ratings over operating free-air temperature range (unless otherwise noted)†**

Supply voltage range, $V_{CCA}$ and $V_{CCB}$ .....	-0.5 V to 4.6 V
Input voltage range, $V_I$ (see Note 1): I/O ports (A port) .....	-0.5 V to 4.6 V
I/O ports (B port) .....	-0.5 V to 4.6 V
Control inputs .....	-0.5 V to 4.6 V
Voltage range applied to any output in the high-impedance or power-off state, $V_O$ (see Note 1): A port .....	-0.5 V to 4.6 V
B port .....	-0.5 V to 4.6 V
Voltage range applied to any output in the high or low state, $V_O$ (see Notes 1 and 2): A port .....	-0.5 V to $V_{CCA} + 0.5$ V
B port .....	-0.5 V to $V_{CCB} + 0.5$ V
Input clamp current, $I_{IK}$ ( $V_I < 0$ ) .....	-50 mA
Output clamp current, $I_{OK}$ ( $V_O < 0$ ) .....	-50 mA
Continuous output current, $I_O$ .....	$\pm 50$ mA
Continuous current through each $V_{CCA}$ , $V_{CCB}$ , and GND .....	$\pm 100$ mA
Package thermal impedance, $\theta_{JA}$ (see Note 3): DGG package .....	70°C/W
DGV package .....	58°C/W
GQL/ZQL package .....	42°C/W
Storage temperature range, $T_{stg}$ .....	-65°C to 150°C

† Stresses beyond those listed under “absolute maximum ratings” may cause permanent damage to the device. These are stress ratings only, and functional operation of the device at these or any other conditions beyond those indicated under “recommended operating conditions” is not implied. Exposure to absolute-maximum-rated conditions for extended periods may affect device reliability.

- NOTES: 1. The input voltage and output negative-voltage ratings may be exceeded if the input and output current ratings are observed.  
 2. The output positive-voltage rating may be exceeded up to 4.6 V maximum if the output current rating is observed.  
 3. The package thermal impedance is calculated in accordance with JESD 51-7.

# SN74AVCH16T245

## 16-BIT DUAL-SUPPLY BUS TRANSCEIVER

### WITH CONFIGURABLE VOLTAGE TRANSLATION AND 3-STATE OUTPUTS

SCES587B – AUGUST 2004 – REVISED APRIL 2005

#### recommended operating conditions (see Notes 4 through 8)

			V <sub>CCI</sub>	V <sub>CCO</sub>	MIN	MAX	UNIT
V <sub>CCA</sub>	Supply voltage				1.2	3.6	V
V <sub>CCB</sub>	Supply voltage				1.2	3.6	V
V <sub>IH</sub>	High-level input voltage	Data inputs (see Note 7)	1.2 V to 1.95 V		V <sub>CCI</sub> × 0.65		V
			1.95 V to 2.7 V		1.6		
			2.7 V to 3.6 V		2		
V <sub>IL</sub>	Low-level input voltage	Data inputs (see Note 7)	1.2 V to 1.95 V		V <sub>CCI</sub> × 0.35		V
			1.95 V to 2.7 V		0.7		
			2.7 V to 3.6 V		0.8		
V <sub>IH</sub>	High-level input voltage	DIR (referenced to V <sub>CCA</sub> ) (see Note 8)	1.2 V to 1.95 V		V <sub>CCA</sub> × 0.65		V
			1.95 V to 2.7 V		1.6		
			2.7 V to 3.6 V		2		
V <sub>IL</sub>	Low-level input voltage	DIR (referenced to V <sub>CCA</sub> ) (see Note 8)	1.2 V to 1.95 V		V <sub>CCA</sub> × 0.35		V
			1.95 V to 2.7 V		0.7		
			2.7 V to 3.6 V		0.8		
V <sub>I</sub>	Input voltage				0	3.6	V
V <sub>O</sub>	Output voltage	Active state			0	V <sub>CCO</sub>	V
		3-state			0	3.6	
I <sub>OH</sub>	High-level output current		1.2 V		-3		mA
			1.4 V to 1.6 V		-6		
			1.65 V to 1.95 V		-8		
			2.3 V to 2.7 V		-9		
			3 V to 3.6 V		-12		
I <sub>OL</sub>	Low-level output current		1.2 V		3		mA
			1.4 V to 1.6 V		6		
			1.65 V to 1.95 V		8		
			2.3 V to 2.7 V		9		
			3 V to 3.6 V		12		
Δt/Δv	Input transition rise or fall rate				5		ns/V
T <sub>A</sub>	Operating free-air temperature				-40	85	°C

- NOTES:
- V<sub>CCI</sub> is the V<sub>CC</sub> associated with the data input port.
  - V<sub>CCO</sub> is the V<sub>CC</sub> associated with the output port.
  - All unused data inputs of the device must be held at V<sub>CCI</sub> or GND to ensure proper device operation. Refer to the TI application report, *Implications of Slow or Floating CMOS Inputs*, literature number SCBA004.
  - For V<sub>CCI</sub> values not specified in the data sheet, V<sub>IH</sub> min = V<sub>CCI</sub> × 0.7 V, V<sub>IL</sub> max = V<sub>CCI</sub> × 0.3 V.
  - For V<sub>CCI</sub> values not specified in the data sheet, V<sub>IH</sub> min = V<sub>CCA</sub> × 0.7 V, V<sub>IL</sub> max = V<sub>CCA</sub> × 0.3 V.



**SN74AVCH16T245**  
**16-BIT DUAL-SUPPLY BUS TRANSCEIVER**  
**WITH CONFIGURABLE VOLTAGE TRANSLATION AND 3-STATE OUTPUTS**

SCES587B – AUGUST 2004 – REVISED APRIL 2005

electrical characteristics over recommended operating free-air temperature range (unless otherwise noted) (see Notes 9 and 10)

PARAMETER	TEST CONDITIONS		V <sub>CCA</sub>	V <sub>CCB</sub>	T <sub>A</sub> = 25°C			-40°C TO 85°C		UNIT
					MIN	TYP	MAX	MIN	MAX	
V <sub>OH</sub>	I <sub>OH</sub> = -100 μA I <sub>OH</sub> = -3 mA I <sub>OH</sub> = -6 mA I <sub>OH</sub> = -8 mA I <sub>OH</sub> = -9 mA I <sub>OH</sub> = -12 mA	V <sub>I</sub> = V <sub>IH</sub>	1.2 V to 3.6 V	1.2 V to 3.6 V				V <sub>CCO</sub> - 0.2 V		V
			1.2 V	1.2 V	0.95					
			1.4 V	1.4 V				1.05		
			1.65 V	1.65 V				1.2		
			2.3 V	2.3 V				1.75		
			3 V	3 V				2.3		
V <sub>OL</sub>	I <sub>OL</sub> = 100 μA I <sub>OL</sub> = 3 mA I <sub>OL</sub> = 6 mA I <sub>OL</sub> = 8 mA I <sub>OL</sub> = 9 mA I <sub>OL</sub> = 12 mA	V <sub>I</sub> = V <sub>IL</sub>	1.2 V to 3.6 V	1.2 V to 3.6 V				0.2		V
			1.2 V	1.2 V	0.15					
			1.4 V	1.4 V				0.35		
			1.65 V	1.65 V				0.45		
			2.3 V	2.3 V				0.55		
			3 V	3 V				0.7		
I <sub>I</sub>	Control inputs	V <sub>I</sub> = V <sub>CCA</sub> or GND	1.2 V to 3.6 V	1.2 V to 3.6 V		±0.025	±0.25		±1	μA
I <sub>BHL</sub> <sup>†</sup>			1.2 V	1.2 V		25				μA
			1.4 V	1.4 V			15			
			1.65 V	1.65 V			25			
			2.3 V	2.3 V			45			
			3.3 V	3.3 V			100			
I <sub>BHH</sub> <sup>‡</sup>			1.2 V	1.2 V		-25				μA
			1.4 V	1.4 V			-15			
			1.65 V	1.65 V			-25			
			2.3 V	2.3 V			-45			
			3.3 V	3.3 V			-100			
I <sub>BHLO</sub> <sup>§</sup>	V <sub>I</sub> = 0 to V <sub>CC</sub>		1.2 V	1.2 V		50				μA
			1.6 V	1.6 V			125			
			1.95 V	1.95 V			200			
			2.7 V	2.7 V			300			
			3.6 V	3.6 V			500			
I <sub>BHHO</sub> <sup>¶</sup>	V <sub>I</sub> = 0 to V <sub>CC</sub>		1.2 V	1.2 V		-50				μA
			1.6 V	1.6 V			-125			
			1.95 V	1.95 V			-200			
			2.7 V	2.7 V			-300			
			3.6 V	3.6 V			-500			

<sup>†</sup> The bus-hold circuit can sink at least the minimum low sustaining current at V<sub>I</sub>L max. I<sub>BHL</sub> should be measured after lowering V<sub>I</sub>N to GND and then raising it to V<sub>I</sub>L max.

<sup>‡</sup> The bus-hold circuit can source at least the minimum high sustaining current at V<sub>I</sub>H min. I<sub>BHH</sub> should be measured after raising V<sub>I</sub>N to V<sub>CC</sub> and then lowering it to V<sub>I</sub>H min.

<sup>§</sup> An external driver must source at least I<sub>BHLO</sub> to switch this node from low to high.

<sup>¶</sup> An external driver must sink at least I<sub>BHHO</sub> to switch this node from high to low.

NOTES: 9. V<sub>CCO</sub> is the V<sub>CC</sub> associated with the output port.

10. V<sub>CCI</sub> is the V<sub>CC</sub> associated with the input port.



# SN74AVCH16T245

## 16-BIT DUAL-SUPPLY BUS TRANSCEIVER

### WITH CONFIGURABLE VOLTAGE TRANSLATION AND 3-STATE OUTPUTS

SCES587B – AUGUST 2004 – REVISED APRIL 2005

electrical characteristics over recommended operating free-air temperature range (unless otherwise noted) (see Notes 9 and 10) (continued)

PARAMETER	TEST CONDITIONS	V <sub>CCA</sub>	V <sub>CCB</sub>	T <sub>A</sub> = 25°C			-40°C TO 85°C		UNIT	
				MIN	TYP	MAX	MIN	MAX		
I <sub>off</sub>	A port	V <sub>I</sub> or V <sub>O</sub> = 0 to 3.6 V	0 V	0 to 3.6 V	±0.1	±2.5	±5		μA	
	B port		0 to 3.6 V	0 V	±0.1	±2.5	±5			
I <sub>OZ</sub> #	A or B ports	V <sub>O</sub> = V <sub>CCO</sub> or GND, V <sub>I</sub> = V <sub>CCI</sub> or GND	$\overline{OE} = V_{IH}$	3.6 V	3.6 V	±0.5	±2.5	±5		μA
	B port		$\overline{OE} = \text{don't care}$	0 V	3.6 V			±5		
	A port		$\overline{OE} = \text{don't care}$	3.6 V	0 V			±5		
I <sub>CCA</sub>	V <sub>I</sub> = V <sub>CCI</sub> or GND, I <sub>O</sub> = 0	1.2 V to 3.6 V	1.2 V to 3.6 V			25		μA		
		0 V	3.6 V			-5				
		3.6 V	0 V			25				
I <sub>CCB</sub>	V <sub>I</sub> = V <sub>CCI</sub> or GND, I <sub>O</sub> = 0	1.2 V to 3.6 V	1.2 V to 3.6 V			25		μA		
		0 V	3.6 V			25				
		3.6 V	0 V			-5				
I <sub>CCA</sub> + I <sub>CCB</sub>	V <sub>I</sub> = V <sub>CCI</sub> or GND, I <sub>O</sub> = 0	1.2 V to 3.6 V	1.2 V to 3.6 V			45		μA		
C <sub>i</sub>	Control inputs	V <sub>I</sub> = 3.3 V or GND	3.3 V	3.3 V	3.5				pF	
C <sub>io</sub>	A or B ports	V <sub>O</sub> = 3.3 V or GND	3.3 V	3.3 V	7				pF	

# For I/O ports, the parameter I<sub>OZ</sub> includes the input leakage current.

NOTES: 9. V<sub>CCO</sub> is the V<sub>CC</sub> associated with the output port.

10. V<sub>CCI</sub> is the V<sub>CC</sub> associated with the input port.

switching characteristics over recommended operating free-air temperature range,  
V<sub>CCA</sub> = 1.2 V (see Figure 1)

PARAMETER	FROM (INPUT)	TO (OUTPUT)	V <sub>CCB</sub> = 1.2 V	V <sub>CCB</sub> = 1.5 V	V <sub>CCB</sub> = 1.8 V	V <sub>CCB</sub> = 2.5 V	V <sub>CCB</sub> = 3.3 V	UNIT
			TYP	TYP	TYP	TYP	TYP	
t <sub>PLH</sub>	A	B	4.1	3.3	3	2.8	3.2	ns
t <sub>PHL</sub>			4.1	3.3	3	2.8	3.2	
t <sub>PLH</sub>	B	A	4.4	4	3.8	3.6	3.5	ns
t <sub>PHL</sub>			4.4	4	3.8	3.6	3.5	
t <sub>PZH</sub>	$\overline{OE}$	A	6.4	6.4	6.4	6.4	6.4	ns
t <sub>PZL</sub>			6.4	6.4	6.4	6.4	6.4	
t <sub>PZH</sub>	$\overline{OE}$	B	6	4.6	4	3.4	3.2	ns
t <sub>PZL</sub>			6	4.6	4	3.4	3.2	
t <sub>PHZ</sub>	$\overline{OE}$	A	6.6	6.6	6.6	6.6	6.8	ns
t <sub>PLZ</sub>			6.6	6.6	6.6	6.6	6.8	
t <sub>PHZ</sub>	$\overline{OE}$	B	6	4.9	4.9	4.2	5.3	ns
t <sub>PLZ</sub>			6	4.9	4.9	4.2	5.3	



**SN74AVCH16T245**  
**16-BIT DUAL-SUPPLY BUS TRANSCEIVER**  
**WITH CONFIGURABLE VOLTAGE TRANSLATION AND 3-STATE OUTPUTS**

SCES587B – AUGUST 2004 – REVISED APRIL 2005

switching characteristics over recommended operating free-air temperature range,  
 $V_{CCA} = 1.5\text{ V} \pm 0.1\text{ V}$  (see Figure 1)

PARAMETER	FROM (INPUT)	TO (OUTPUT)	$V_{CCB} = 1.2\text{ V}$	$V_{CCB} = 1.5\text{ V} \pm 0.1\text{ V}$		$V_{CCB} = 1.8\text{ V} \pm 0.15\text{ V}$		$V_{CCB} = 2.5\text{ V} \pm 0.2\text{ V}$		$V_{CCB} = 3.3\text{ V} \pm 0.3\text{ V}$		UNIT
			TYP	MIN	MAX	MIN	MAX	MIN	MAX	MIN	MAX	
$t_{PLH}$	A	B	3.6	0.5	6.2	0.5	5.2	0.5	4.1	0.5	3.7	ns
$t_{PHL}$			3.6	0.5	6.2	0.5	5.2	0.5	4.1	0.5	3.7	
$t_{PLH}$	B	A	3.3	0.5	6.2	0.5	5.9	0.5	5.6	0.5	5.5	ns
$t_{PHL}$			3.3	0.5	6.2	0.5	5.9	0.5	5.6	0.5	5.5	
$t_{PZH}$	$\overline{OE}$	A	4.3	1	10.1	1	10.1	1	10.1	1	10.1	ns
$t_{PZL}$			4.3	1	10.1	1	10.1	1	10.1	1	10.1	
$t_{PZH}$	$\overline{OE}$	B	5.6	1	10.1	0.5	8.1	0.5	5.9	0.5	5.2	ns
$t_{PZL}$			5.6	1	10.1	0.5	8.1	0.5	5.9	0.5	5.2	
$t_{PHZ}$	$\overline{OE}$	A	4.5	1.5	9.1	1.5	9.1	1.5	9.1	1.5	9.1	ns
$t_{PLZ}$			4.5	1.5	9.1	1.5	9.1	1.5	9.1	1.5	9.1	
$t_{PHZ}$	$\overline{OE}$	B	5.5	1.5	8.7	1.5	7.5	1	6.5	1	6.3	ns
$t_{PLZ}$			5.5	1.5	8.7	1.5	7.5	1	6.5	1	6.3	

switching characteristics over recommended operating free-air temperature range,  
 $V_{CCA} = 1.8\text{ V} \pm 0.15\text{ V}$  (see Figure 1)

PARAMETER	FROM (INPUT)	TO (OUTPUT)	$V_{CCB} = 1.2\text{ V}$	$V_{CCB} = 1.5\text{ V} \pm 0.1\text{ V}$		$V_{CCB} = 1.8\text{ V} \pm 0.15\text{ V}$		$V_{CCB} = 2.5\text{ V} \pm 0.2\text{ V}$		$V_{CCB} = 3.3\text{ V} \pm 0.3\text{ V}$		UNIT
			TYP	MIN	MAX	MIN	MAX	MIN	MAX	MIN	MAX	
$t_{PLH}$	A	B	3.4	0.5	5.9	0.5	4.8	0.5	3.7	0.5	3.3	ns
$t_{PHL}$			3.4	0.5	5.9	0.5	4.8	0.5	3.7	0.5	3.3	
$t_{PLH}$	B	A	3	0.5	5.2	0.5	4.8	0.5	4.5	0.5	4.4	ns
$t_{PHL}$			3	0.5	5.2	0.5	4.8	0.5	4.5	0.5	4.4	
$t_{PZH}$	$\overline{OE}$	A	3.4	1	7.8	1	7.8	1	7.8	1	7.8	ns
$t_{PZL}$			3.4	1	7.8	1	7.8	1	7.8	1	7.8	
$t_{PZH}$	$\overline{OE}$	B	5.4	1	9.2	0.5	7.4	0.5	5.3	0.5	4.5	ns
$t_{PZL}$			5.4	1	9.2	0.5	7.4	0.5	5.3	0.5	4.5	
$t_{PHZ}$	$\overline{OE}$	A	4.2	1.5	7.7	1.5	7.7	1.5	7.7	1.5	7.7	ns
$t_{PLZ}$			4.2	1.5	7.7	1.5	7.7	1.5	7.7	1.5	7.7	
$t_{PHZ}$	$\overline{OE}$	B	5.2	1.5	8.4	1.5	7.1	1	5.9	1	5.7	ns
$t_{PLZ}$			5.2	1.5	8.4	1.5	7.1	1	5.9	1	5.7	

# SN74AVCH16T245

## 16-BIT DUAL-SUPPLY BUS TRANSCEIVER

### WITH CONFIGURABLE VOLTAGE TRANSLATION AND 3-STATE OUTPUTS

SCES587B – AUGUST 2004 – REVISED APRIL 2005

switching characteristics over recommended operating free-air temperature range,  
 $V_{CCA} = 2.5\text{ V} \pm 0.2\text{ V}$  (see Figure 1)

PARAMETER	FROM (INPUT)	TO (OUTPUT)	$V_{CCB} = 1.2\text{ V}$	$V_{CCB} = 1.5\text{ V} \pm 0.1\text{ V}$		$V_{CCB} = 1.8\text{ V} \pm 0.15\text{ V}$		$V_{CCB} = 2.5\text{ V} \pm 0.2\text{ V}$		$V_{CCB} = 3.3\text{ V} \pm 0.3\text{ V}$		UNIT
			TYP	MIN	MAX	MIN	MAX	MIN	MAX	MIN	MAX	
$t_{PLH}$	A	B	3.2	0.5	5.6	0.5	4.5	0.5	3.3	0.5	2.8	ns
$t_{PHL}$			3.2	0.5	5.6	0.5	4.5	0.5	3.3	0.5	2.8	
$t_{PLH}$	B	A	2.6	0.5	4.1	0.5	3.7	0.5	3.3	0.5	3.2	ns
$t_{PHL}$			2.6	0.5	4.1	0.5	3.7	0.5	3.3	0.5	3.2	
$t_{PZH}$	$\overline{OE}$	A	2.5	0.5	5.3	0.5	5.3	0.5	5.3	0.5	5.3	ns
$t_{PZL}$			2.5	0.5	5.3	0.5	5.3	0.5	5.3	0.5	5.3	
$t_{PZH}$	$\overline{OE}$	B	5.2	0.5	9.4	0.5	7.3	0.5	5.1	0.5	4.5	ns
$t_{PZL}$			5.2	0.5	9.4	0.5	7.3	0.5	5.1	0.5	4.5	
$t_{PHZ}$	$\overline{OE}$	A	3	1	6.1	1	6.1	1	6.1	1	6.1	ns
$t_{PLZ}$			3	1	6.1	1	6.1	1	6.1	1	6.1	
$t_{PHZ}$	$\overline{OE}$	B	5	1	7.9	1	6.6	1	6.1	1	5.2	ns
$t_{PLZ}$			5	1	7.9	1	6.6	1	6.1	1	5.2	

switching characteristics over recommended operating free-air temperature range,  
 $V_{CCA} = 3.3\text{ V} \pm 0.3\text{ V}$  (see Figure 1)

PARAMETER	FROM (INPUT)	TO (OUTPUT)	$V_{CCB} = 1.2\text{ V}$	$V_{CCB} = 1.5\text{ V} \pm 0.1\text{ V}$		$V_{CCB} = 1.8\text{ V} \pm 0.15\text{ V}$		$V_{CCB} = 2.5\text{ V} \pm 0.2\text{ V}$		$V_{CCB} = 3.3\text{ V} \pm 0.3\text{ V}$		UNIT
			TYP	MIN	MAX	MIN	MAX	MIN	MAX	MIN	MAX	
$t_{PLH}$	A	B	3.2	0.5	5.5	0.5	4.4	0.5	3.2	0.5	2.7	ns
$t_{PHL}$			3.2	0.5	5.5	0.5	4.4	0.5	3.2	0.5	2.7	
$t_{PLH}$	B	A	2.8	0.5	3.7	0.5	3.3	0.5	2.8	0.5	2.7	ns
$t_{PHL}$			2.8	0.5	3.7	0.5	3.3	0.5	2.8	0.5	2.7	
$t_{PZH}$	$\overline{OE}$	A	2.2	0.5	4.3	0.5	4.2	0.5	4.1	0.5	4	ns
$t_{PZL}$			2.2	0.5	4.3	0.5	4.2	0.5	4.1	0.5	4	
$t_{PZH}$	$\overline{OE}$	B	5.1	0.5	9.3	0.5	7.2	0.5	4.9	0.5	4	ns
$t_{PZL}$			5.1	0.5	9.3	0.5	7.2	0.5	4.9	0.5	4	
$t_{PHZ}$	$\overline{OE}$	A	3.4	0.5	5	0.5	5	0.5	5	0.5	5	ns
$t_{PLZ}$			3.4	0.5	5	0.5	5	0.5	5	0.5	5	
$t_{PHZ}$	$\overline{OE}$	B	4.9	1	7.7	1	6.5	1	5.2	0.5	5	ns
$t_{PLZ}$			4.9	1	7.7	1	6.5	1	5.2	0.5	5	



**SN74AVCH16T245**  
**16-BIT DUAL-SUPPLY BUS TRANSCEIVER**  
**WITH CONFIGURABLE VOLTAGE TRANSLATION AND 3-STATE OUTPUTS**

SCES587B – AUGUST 2004 – REVISED APRIL 2005

operating characteristics,  $T_A = 25^\circ\text{C}$

PARAMETER			TEST CONDITIONS	$V_{CCA} =$ $V_{CCB} = 1.2\text{ V}$	$V_{CCA} =$ $V_{CCB} = 1.5\text{ V}$	$V_{CCA} =$ $V_{CCB} = 1.8\text{ V}$	$V_{CCA} =$ $V_{CCB} = 2.5\text{ V}$	$V_{CCA} =$ $V_{CCB} = 3.3\text{ V}$	UNIT
				TYP	TYP	TYP	TYP	TYP	
$C_{pdA}^\dagger$	A to B	Outputs enabled	$C_L = 0,$ $f = 10\text{ MHz},$ $t_r = t_f = 1\text{ ns}$	1	1	1	1	2	pF
		Outputs disabled		1	1	1	1	1	
	B to A	Outputs enabled		13	13	14	15	16	
		Outputs disabled		1	1	1	1	1	
$C_{pdB}^\dagger$	A to B	Outputs enabled	$C_L = 0,$ $f = 10\text{ MHz},$ $t_r = t_f = 1\text{ ns}$	13	13	14	15	16	pF
		Outputs disabled		1	1	1	1	1	
	B to A	Outputs enabled		1	1	1	1	2	
		Outputs disabled		1	1	1	1	1	

$^\dagger$  Power-dissipation capacitance per transceiver

typical total static power consumption ( $I_{CCA} + I_{CCB}$ )

Table 1

$V_{CCB}$	$V_{CCA}$						UNIT
	0 V	1.2 V	1.5 V	1.8 V	2.5 V	3.3 V	
0 V	0	< 0.5	< 0.5	< 0.5	< 0.5	< 0.5	$\mu\text{A}$
1.2 V	< 0.5	< 1	< 1	< 1	< 1	1	
1.5 V	< 0.5	< 1	< 1	< 1	< 1	1	
1.8 V	< 0.5	< 1	< 1	< 1	< 1	< 1	
2.5 V	< 0.5	1	< 1	< 1	< 1	< 1	
3.3 V	< 0.5	1	< 1	< 1	< 1	< 1	

**SN74AVCH16T245**  
**16-BIT DUAL-SUPPLY BUS TRANSCEIVER**  
**WITH CONFIGURABLE VOLTAGE TRANSLATION AND 3-STATE OUTPUTS**

SCES587B – AUGUST 2004 – REVISED APRIL 2005

**TYPICAL CHARACTERISTICS**

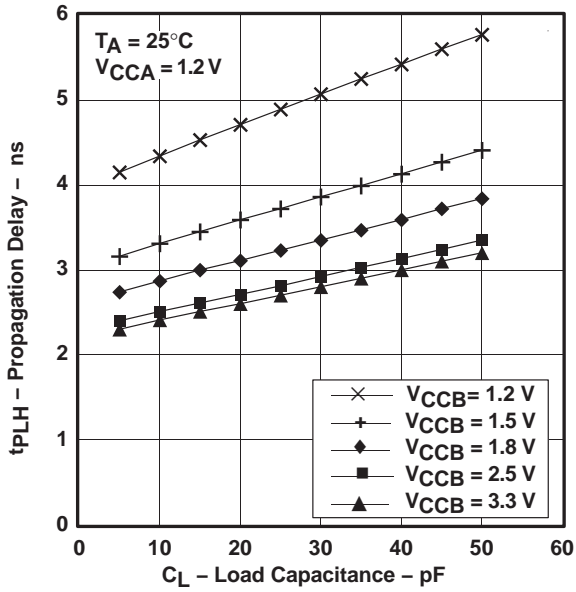

Figure 1

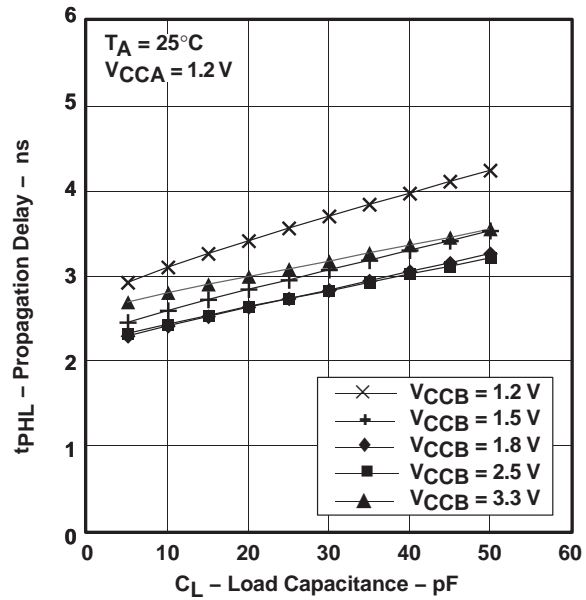

Figure 2

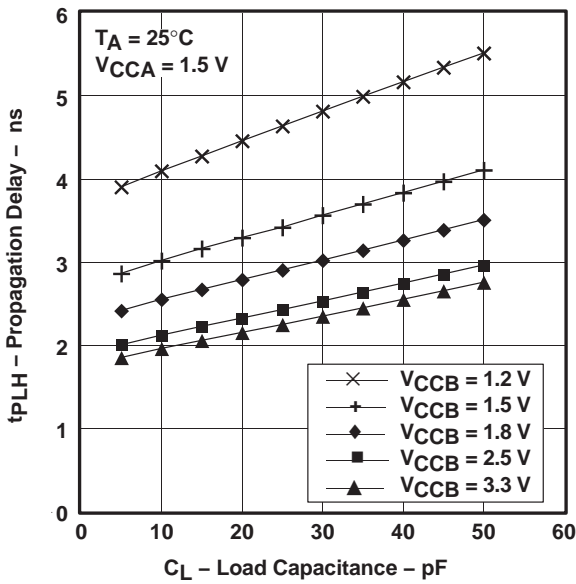

Figure 3

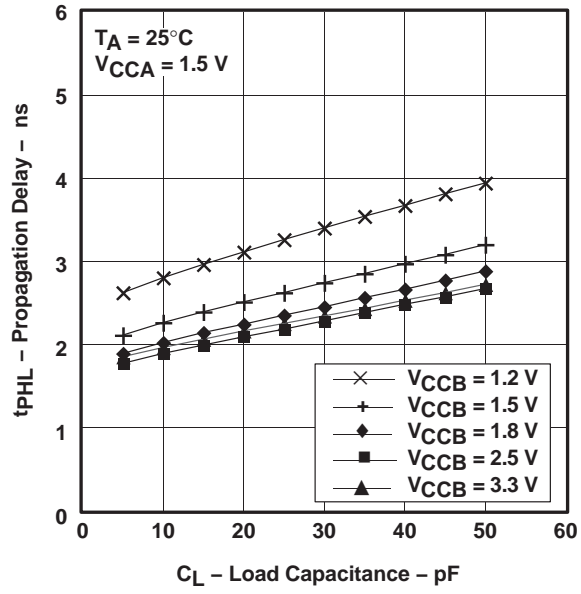

Figure 4

**SN74AVCH16T245**  
**16-BIT DUAL-SUPPLY BUS TRANSCEIVER**  
**WITH CONFIGURABLE VOLTAGE TRANSLATION AND 3-STATE OUTPUTS**

SCES587B – AUGUST 2004 – REVISED APRIL 2005

**TYPICAL CHARACTERISTICS**

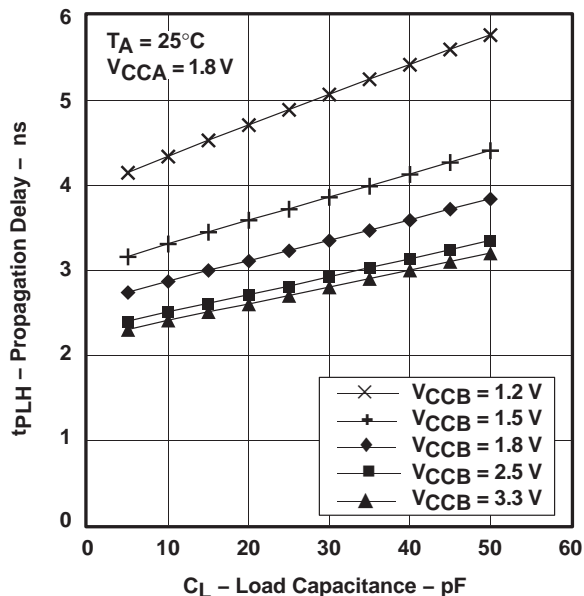

Figure 5

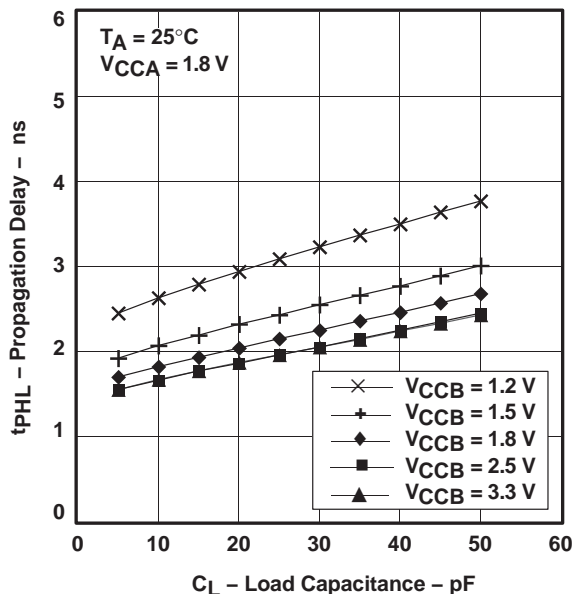

Figure 6

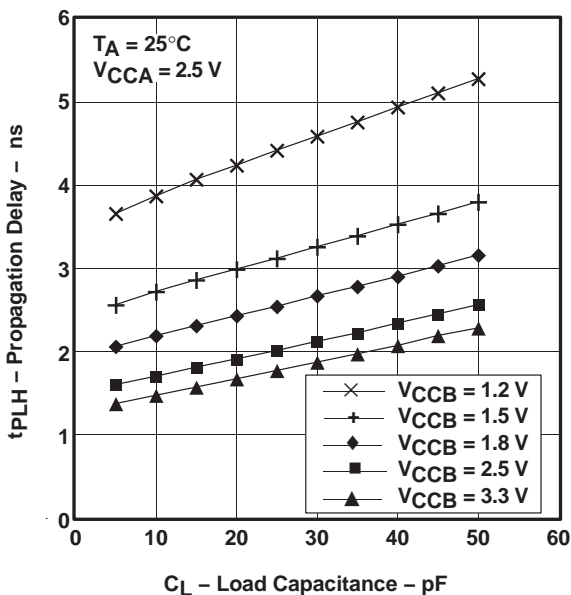

Figure 7

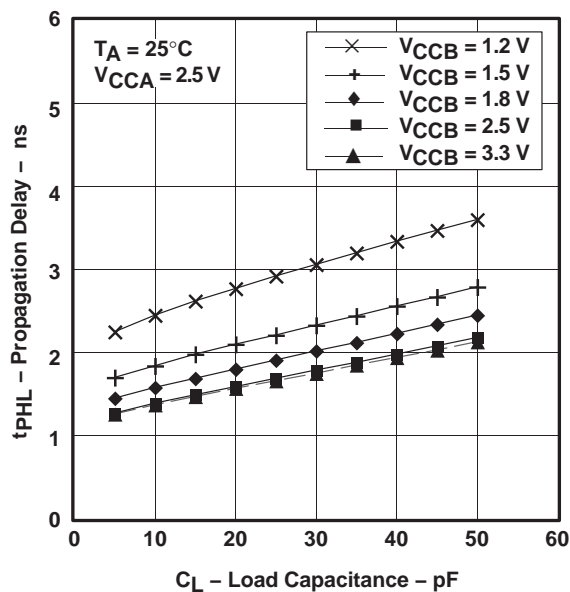

Figure 8

**SN74AVCH16T245**  
**16-BIT DUAL-SUPPLY BUS TRANSCEIVER**  
**WITH CONFIGURABLE VOLTAGE TRANSLATION AND 3-STATE OUTPUTS**  
 SCE587B – AUGUST 2004 – REVISED APRIL 2005

**TYPICAL CHARACTERISTICS**

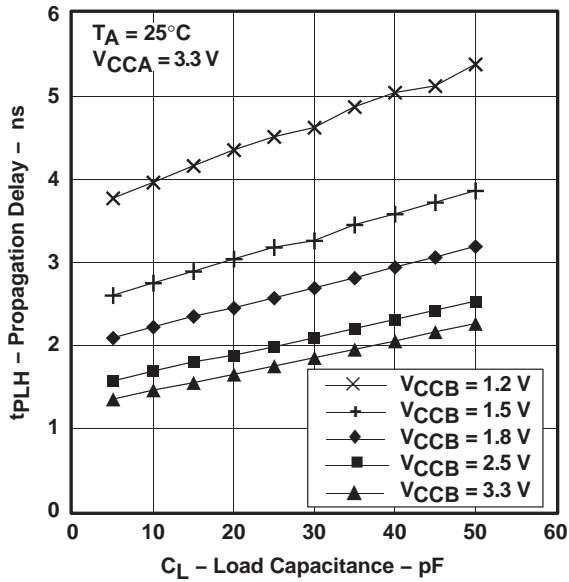

Figure 9

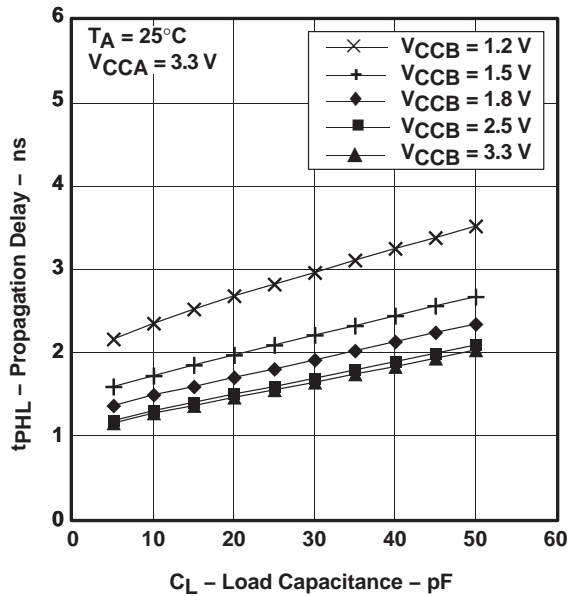
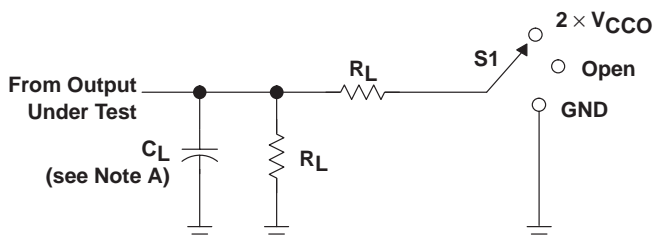

Figure 10

**SN74AVCH16T245**  
**16-BIT DUAL-SUPPLY BUS TRANSCEIVER**  
**WITH CONFIGURABLE VOLTAGE TRANSLATION AND 3-STATE OUTPUTS**

SCES587B – AUGUST 2004 – REVISED APRIL 2005

**PARAMETER MEASUREMENT INFORMATION**



**LOAD CIRCUIT**

$V_{CCO}$	$C_L$	$R_L$	$V_{TP}$
1.2 V	15 pF	2 k $\Omega$	0.1 V
1.5 V $\pm$ 0.1 V	15 pF	2 k $\Omega$	0.1 V
1.8 V $\pm$ 0.15 V	15 pF	2 k $\Omega$	0.15 V
2.5 V $\pm$ 0.2 V	15 pF	2 k $\Omega$	0.15 V
3.3 V $\pm$ 0.3 V	15 pF	2 k $\Omega$	0.3 V

TEST	S1
$t_{pd}$	Open
$t_{PLZ}/t_{PZL}$	$2 \times V_{CCO}$
$t_{PHZ}/t_{PZH}$	GND

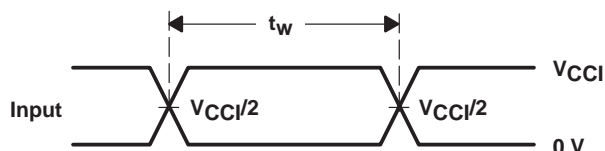

**VOLTAGE WAVEFORMS  
PULSE DURATION**

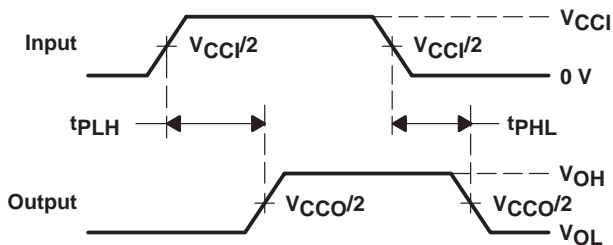

**VOLTAGE WAVEFORMS  
PROPAGATION DELAY TIMES**

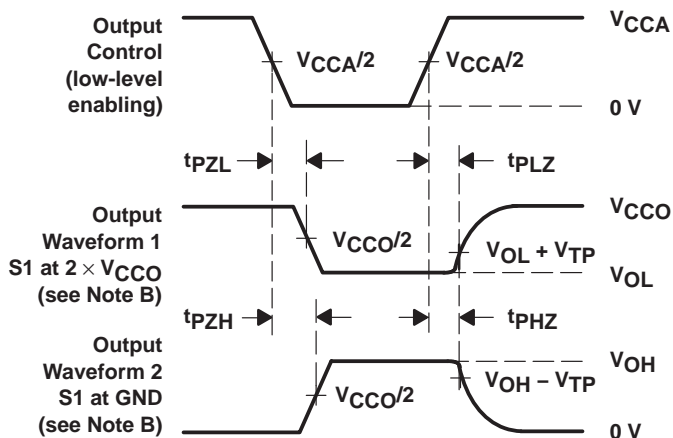

**VOLTAGE WAVEFORMS  
ENABLE AND DISABLE TIMES**

- NOTES:
- $C_L$  includes probe and jig capacitance.
  - Waveform 1 is for an output with internal conditions such that the output is low, except when disabled by the output control. Waveform 2 is for an output with internal conditions such that the output is high, except when disabled by the output control.
  - All input pulses are supplied by generators having the following characteristics:  $PRR \leq 10$  MHz,  $Z_O = 50 \Omega$ ,  $dv/dt \geq 1$  V/ns,  $dv/dt \geq 1$  V/ns.
  - The outputs are measured one at a time, with one transition per measurement.
  - $t_{PLZ}$  and  $t_{PHZ}$  are the same as  $t_{dis}$ .
  - $t_{PZL}$  and  $t_{PZH}$  are the same as  $t_{en}$ .
  - $t_{PLH}$  and  $t_{PHL}$  are the same as  $t_{pd}$ .
  - $V_{CCI}$  is the  $V_{CC}$  associated with the input port.
  - $V_{CCO}$  is the  $V_{CC}$  associated with the output port.

**Figure 11. Load Circuit and Voltage Waveforms**

**PACKAGING INFORMATION**

Orderable Device	Status (1)	Package Type	Package Drawing	Pins	Package Qty	Eco Plan (2)	Lead/Ball Finish (6)	MSL Peak Temp (3)	Op Temp (°C)	Device Marking (4/5)	Samples
74AVCH16T245GRE4	ACTIVE	TSSOP	DGG	48		TBD	Call TI	Call TI	-40 to 85		<a href="#">Samples</a>
74AVCH16T245GRG4	ACTIVE	TSSOP	DGG	48		TBD	Call TI	Call TI	-40 to 85		<a href="#">Samples</a>
74AVCH16T245VRE4	ACTIVE	TVSOP	DGV	48		TBD	Call TI	Call TI	-40 to 85		<a href="#">Samples</a>
74AVCH16T245VRG4	ACTIVE	TVSOP	DGV	48		TBD	Call TI	Call TI	-40 to 85		<a href="#">Samples</a>
74AVCH16T245ZQLR	ACTIVE	BGA MICROSTAR JUNIOR	ZQL	56	1000	Green (RoHS & no Sb/Br)	SNAGCU	Level-1-260C-UNLIM	-40 to 85	WJ245	<a href="#">Samples</a>
SN74AVCH16T245GQLR	OBSOLETE	BGA MICROSTAR JUNIOR	GQL	56		TBD	Call TI	Call TI	-40 to 85	WJ245	
SN74AVCH16T245GR	ACTIVE	TSSOP	DGG	48	2000	Green (RoHS & no Sb/Br)	CU NIPDAU	Level-1-260C-UNLIM	-40 to 85	AVCH16T245	<a href="#">Samples</a>
SN74AVCH16T245VR	ACTIVE	TVSOP	DGV	48	2000	Green (RoHS & no Sb/Br)	CU NIPDAU	Level-1-260C-UNLIM	-40 to 85	WJ245	<a href="#">Samples</a>

(1) The marketing status values are defined as follows:

**ACTIVE:** Product device recommended for new designs.

**LIFEBUY:** TI has announced that the device will be discontinued, and a lifetime-buy period is in effect.

**NRND:** Not recommended for new designs. Device is in production to support existing customers, but TI does not recommend using this part in a new design.

**PREVIEW:** Device has been announced but is not in production. Samples may or may not be available.

**OBSOLETE:** TI has discontinued the production of the device.

(2) Eco Plan - The planned eco-friendly classification: Pb-Free (RoHS), Pb-Free (RoHS Exempt), or Green (RoHS & no Sb/Br) - please check <http://www.ti.com/productcontent> for the latest availability information and additional product content details.

**TBD:** The Pb-Free/Green conversion plan has not been defined.

**Pb-Free (RoHS):** TI's terms "Lead-Free" or "Pb-Free" mean semiconductor products that are compatible with the current RoHS requirements for all 6 substances, including the requirement that lead not exceed 0.1% by weight in homogeneous materials. Where designed to be soldered at high temperatures, TI Pb-Free products are suitable for use in specified lead-free processes.

**Pb-Free (RoHS Exempt):** This component has a RoHS exemption for either 1) lead-based flip-chip solder bumps used between the die and package, or 2) lead-based die adhesive used between the die and leadframe. The component is otherwise considered Pb-Free (RoHS compatible) as defined above.

**Green (RoHS & no Sb/Br):** TI defines "Green" to mean Pb-Free (RoHS compatible), and free of Bromine (Br) and Antimony (Sb) based flame retardants (Br or Sb do not exceed 0.1% by weight in homogeneous material)

(3) MSL, Peak Temp. - The Moisture Sensitivity Level rating according to the JEDEC industry standard classifications, and peak solder temperature.

(4) There may be additional marking, which relates to the logo, the lot trace code information, or the environmental category on the device.

(5) Multiple Device Markings will be inside parentheses. Only one Device Marking contained in parentheses and separated by a "~" will appear on a device. If a line is indented then it is a continuation of the previous line and the two combined represent the entire Device Marking for that device.

(6) Lead/Ball Finish - Orderable Devices may have multiple material finish options. Finish options are separated by a vertical ruled line. Lead/Ball Finish values may wrap to two lines if the finish value exceeds the maximum column width.

**Important Information and Disclaimer:**The information provided on this page represents TI's knowledge and belief as of the date that it is provided. TI bases its knowledge and belief on information provided by third parties, and makes no representation or warranty as to the accuracy of such information. Efforts are underway to better integrate information from third parties. TI has taken and continues to take reasonable steps to provide representative and accurate information but may not have conducted destructive testing or chemical analysis on incoming materials and chemicals. TI and TI suppliers consider certain information to be proprietary, and thus CAS numbers and other limited information may not be available for release.

In no event shall TI's liability arising out of such information exceed the total purchase price of the TI part(s) at issue in this document sold by TI to Customer on an annual basis.

## TAPE AND REEL INFORMATION



### QUADRANT ASSIGNMENTS FOR PIN 1 ORIENTATION IN TAPE



\*All dimensions are nominal

Device	Package Type	Package Drawing	Pins	SPQ	Reel Diameter (mm)	Reel Width W1 (mm)	A0 (mm)	B0 (mm)	K0 (mm)	P1 (mm)	W (mm)	Pin1 Quadrant
74AVCH16T245ZQLR	BGA MICROSTAR JUNIOR	ZQL	56	1000	330.0	16.4	4.8	7.3	1.5	8.0	16.0	Q1
SN74AVCH16T245GR	TSSOP	DGG	48	2000	330.0	24.4	8.6	15.8	1.8	12.0	24.0	Q1
SN74AVCH16T245VR	TVSOP	DGV	48	2000	330.0	16.4	7.1	10.2	1.6	12.0	16.0	Q1

**TAPE AND REEL BOX DIMENSIONS**

\*All dimensions are nominal

Device	Package Type	Package Drawing	Pins	SPQ	Length (mm)	Width (mm)	Height (mm)
74AVCH16T245ZQLR	BGA MICROSTAR JUNIOR	ZQL	56	1000	336.6	336.6	28.6
SN74AVCH16T245GR	TSSOP	DGG	48	2000	367.0	367.0	45.0
SN74AVCH16T245VR	TVSOP	DGV	48	2000	367.0	367.0	38.0

ZQL (R-PBGA-N56)

PLASTIC BALL GRID ARRAY

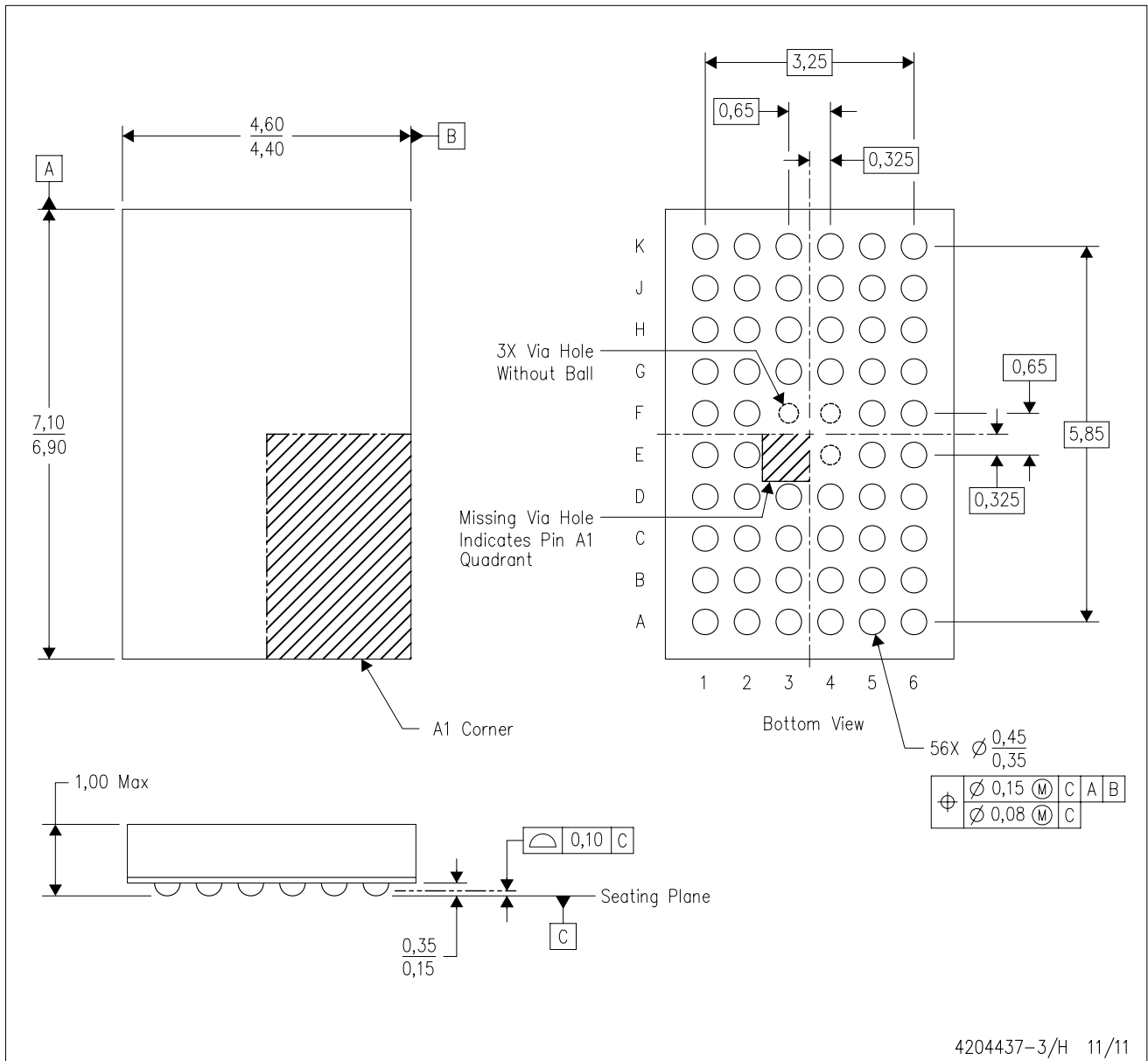

- NOTES:
- A. All linear dimensions are in millimeters. Dimensioning and tolerancing per ASME Y14.5M-1994.
  - B. This drawing is subject to change without notice.
  - C. Falls within JEDEC MO-285 variation BA-2.
  - D. This package is Pb-free. Refer to the 56 GQL package (drawing 4200583) for tin-lead (SnPb).

DGV (R-PDSO-G\*\*)

PLASTIC SMALL-OUTLINE

24 PINS SHOWN



- NOTES: A. All linear dimensions are in millimeters.  
 B. This drawing is subject to change without notice.  
 C. Body dimensions do not include mold flash or protrusion, not to exceed 0,15 per side.  
 D. Falls within JEDEC: 24/48 Pins – MO-153  
 14/16/20/56 Pins – MO-194

GQL (R-PBGA-N56)

PLASTIC BALL GRID ARRAY

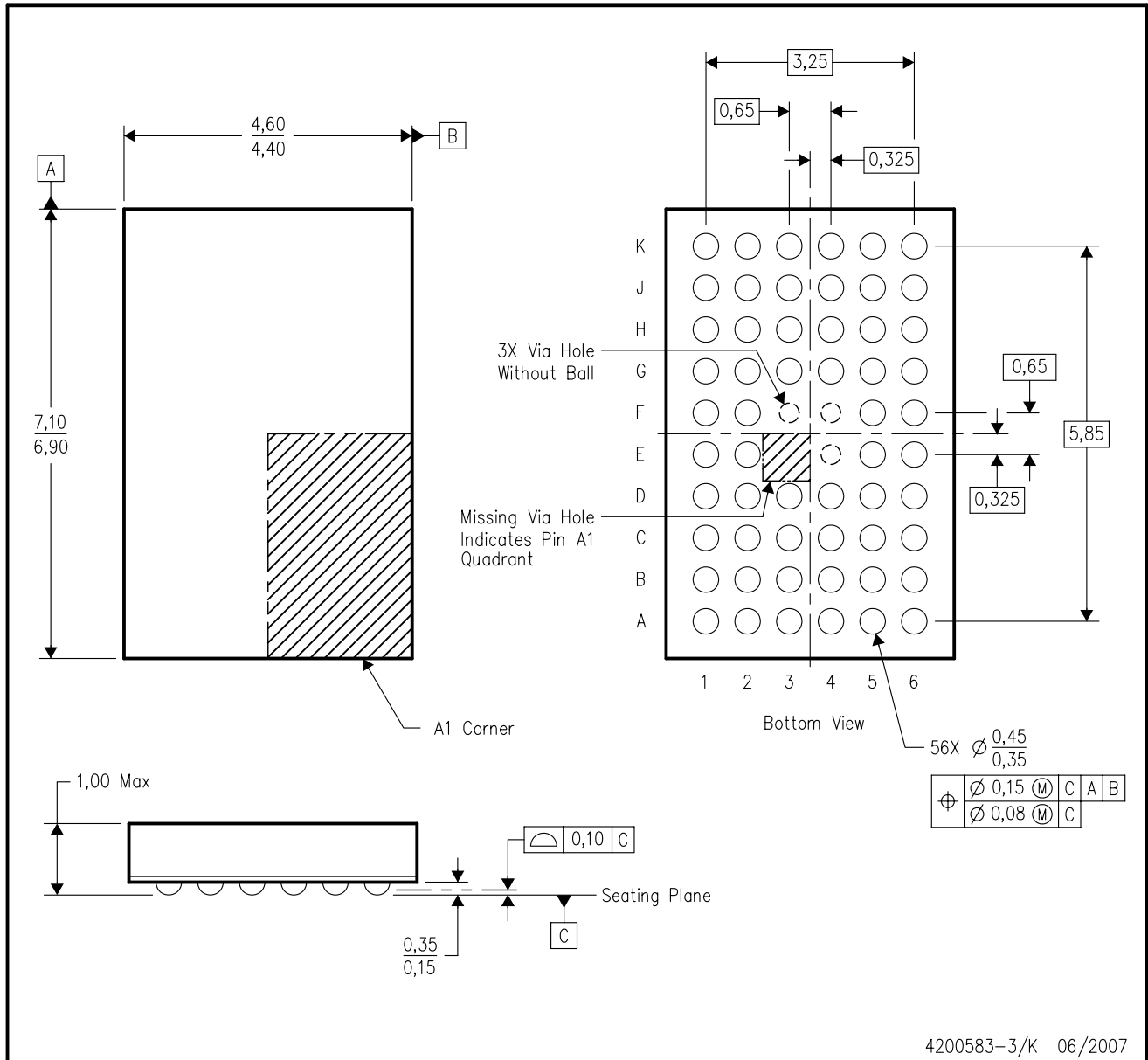

- NOTES:
- A. All linear dimensions are in millimeters. Dimensioning and tolerancing per ASME Y14.5M-1994.
  - B. This drawing is subject to change without notice.
  - C. Falls within JEDEC MO-285 variation BA-2.
  - D. This package is tin-lead (SnPb). Refer to the 56 ZQL package (drawing 4204437) for lead-free.

DGG (R-PDSO-G\*\*)

PLASTIC SMALL-OUTLINE PACKAGE

48 PINS SHOWN

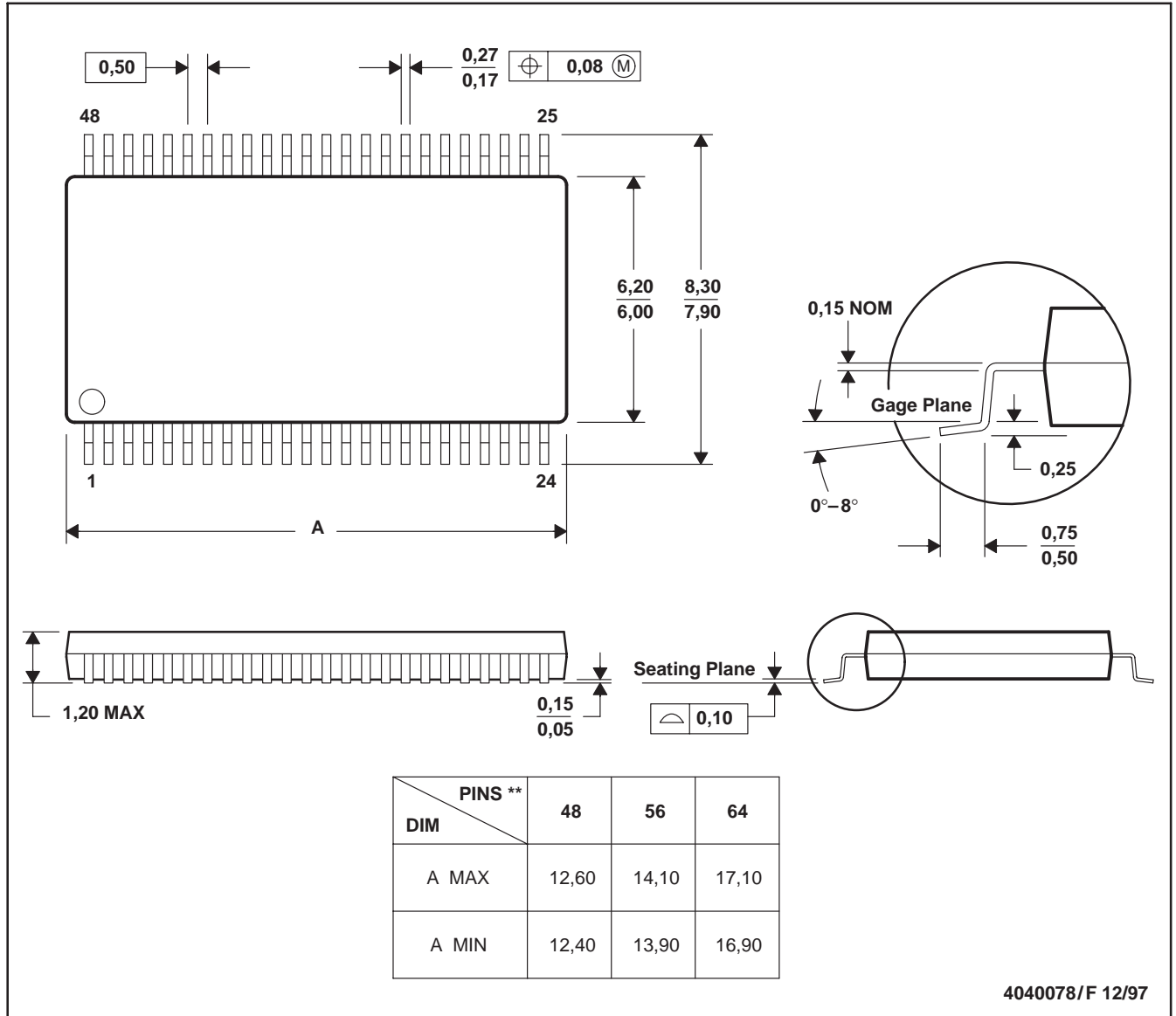

- NOTES: A. All linear dimensions are in millimeters.  
 B. This drawing is subject to change without notice.  
 C. Body dimensions do not include mold protrusion not to exceed 0,15.  
 D. Falls within JEDEC MO-153

## IMPORTANT NOTICE

Texas Instruments Incorporated and its subsidiaries (TI) reserve the right to make corrections, enhancements, improvements and other changes to its semiconductor products and services per JESD46, latest issue, and to discontinue any product or service per JESD48, latest issue. Buyers should obtain the latest relevant information before placing orders and should verify that such information is current and complete. All semiconductor products (also referred to herein as "components") are sold subject to TI's terms and conditions of sale supplied at the time of order acknowledgment.

TI warrants performance of its components to the specifications applicable at the time of sale, in accordance with the warranty in TI's terms and conditions of sale of semiconductor products. Testing and other quality control techniques are used to the extent TI deems necessary to support this warranty. Except where mandated by applicable law, testing of all parameters of each component is not necessarily performed.

TI assumes no liability for applications assistance or the design of Buyers' products. Buyers are responsible for their products and applications using TI components. To minimize the risks associated with Buyers' products and applications, Buyers should provide adequate design and operating safeguards.

TI does not warrant or represent that any license, either express or implied, is granted under any patent right, copyright, mask work right, or other intellectual property right relating to any combination, machine, or process in which TI components or services are used. Information published by TI regarding third-party products or services does not constitute a license to use such products or services or a warranty or endorsement thereof. Use of such information may require a license from a third party under the patents or other intellectual property of the third party, or a license from TI under the patents or other intellectual property of TI.

Reproduction of significant portions of TI information in TI data books or data sheets is permissible only if reproduction is without alteration and is accompanied by all associated warranties, conditions, limitations, and notices. TI is not responsible or liable for such altered documentation. Information of third parties may be subject to additional restrictions.

Resale of TI components or services with statements different from or beyond the parameters stated by TI for that component or service voids all express and any implied warranties for the associated TI component or service and is an unfair and deceptive business practice. TI is not responsible or liable for any such statements.

Buyer acknowledges and agrees that it is solely responsible for compliance with all legal, regulatory and safety-related requirements concerning its products, and any use of TI components in its applications, notwithstanding any applications-related information or support that may be provided by TI. Buyer represents and agrees that it has all the necessary expertise to create and implement safeguards which anticipate dangerous consequences of failures, monitor failures and their consequences, lessen the likelihood of failures that might cause harm and take appropriate remedial actions. Buyer will fully indemnify TI and its representatives against any damages arising out of the use of any TI components in safety-critical applications.

In some cases, TI components may be promoted specifically to facilitate safety-related applications. With such components, TI's goal is to help enable customers to design and create their own end-product solutions that meet applicable functional safety standards and requirements. Nonetheless, such components are subject to these terms.

No TI components are authorized for use in FDA Class III (or similar life-critical medical equipment) unless authorized officers of the parties have executed a special agreement specifically governing such use.

Only those TI components which TI has specifically designated as military grade or "enhanced plastic" are designed and intended for use in military/aerospace applications or environments. Buyer acknowledges and agrees that any military or aerospace use of TI components which have **not** been so designated is solely at the Buyer's risk, and that Buyer is solely responsible for compliance with all legal and regulatory requirements in connection with such use.

TI has specifically designated certain components as meeting ISO/TS16949 requirements, mainly for automotive use. In any case of use of non-designated products, TI will not be responsible for any failure to meet ISO/TS16949.

### Products

Audio	<a href="http://www.ti.com/audio">www.ti.com/audio</a>
Amplifiers	<a href="http://amplifier.ti.com">amplifier.ti.com</a>
Data Converters	<a href="http://dataconverter.ti.com">dataconverter.ti.com</a>
DLP® Products	<a href="http://www.dlp.com">www.dlp.com</a>
DSP	<a href="http://dsp.ti.com">dsp.ti.com</a>
Clocks and Timers	<a href="http://www.ti.com/clocks">www.ti.com/clocks</a>
Interface	<a href="http://interface.ti.com">interface.ti.com</a>
Logic	<a href="http://logic.ti.com">logic.ti.com</a>
Power Mgmt	<a href="http://power.ti.com">power.ti.com</a>
Microcontrollers	<a href="http://microcontroller.ti.com">microcontroller.ti.com</a>
RFID	<a href="http://www.ti-rfid.com">www.ti-rfid.com</a>
OMAP Applications Processors	<a href="http://www.ti.com/omap">www.ti.com/omap</a>
Wireless Connectivity	<a href="http://www.ti.com/wirelessconnectivity">www.ti.com/wirelessconnectivity</a>

### Applications

Automotive and Transportation	<a href="http://www.ti.com/automotive">www.ti.com/automotive</a>
Communications and Telecom	<a href="http://www.ti.com/communications">www.ti.com/communications</a>
Computers and Peripherals	<a href="http://www.ti.com/computers">www.ti.com/computers</a>
Consumer Electronics	<a href="http://www.ti.com/consumer-apps">www.ti.com/consumer-apps</a>
Energy and Lighting	<a href="http://www.ti.com/energy">www.ti.com/energy</a>
Industrial	<a href="http://www.ti.com/industrial">www.ti.com/industrial</a>
Medical	<a href="http://www.ti.com/medical">www.ti.com/medical</a>
Security	<a href="http://www.ti.com/security">www.ti.com/security</a>
Space, Avionics and Defense	<a href="http://www.ti.com/space-avionics-defense">www.ti.com/space-avionics-defense</a>
Video and Imaging	<a href="http://www.ti.com/video">www.ti.com/video</a>

### TI E2E Community

[e2e.ti.com](http://e2e.ti.com)