

PolySwitch Radial-leaded Resettable Devices

Raychem Circuit Protection has pioneered PPTC technology for over twenty years. Our radial-leaded products represent the widest range of product capabilities.

- RGE series for hold currents up to 14A
- RHE series for flatter thermal derating and operating temperatures up to 125°C
- RUE series for balance of voltage rating (30V) and hold current (up to 9A)
- RUSB series for fast time-to-trip and low-resistance computer applications
- RTE series specifically designed for IEEE-1394 applications
- RXE series for low hold currents (down to 50mA) and high voltage rating (up to 72V)
- LVR series for line voltage applications up to a continuous operating voltage of 265V_{AC}
- TR600 series for North America telephone applications
- TR250 series for ITU telephone applications
- BBR series for cable telephone applications
- Now offering Pb-free versions of all products. For Pb-free versions of R-line products simply add an "F" to the end of the series description.

Whether for design or volume application, our radial-leaded products represent the most comprehensive and complete set of PPTC products available in the industry today.

Devices in this section are grouped by:

Voltage Rating, Device Series, Hold Current

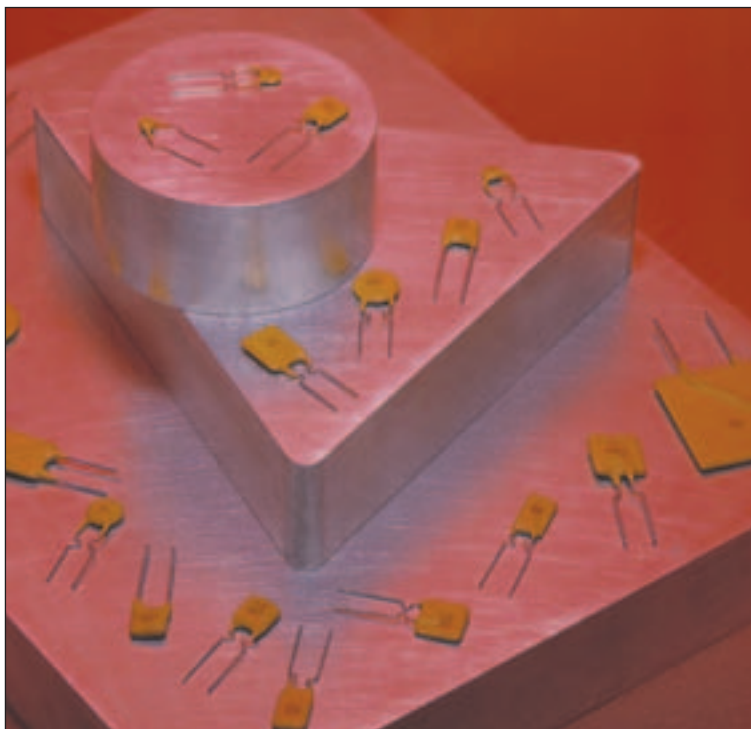

Benefits:

- Many product choices give engineers more design flexibility
- Compatible with high-volume electronics assembly
- Assists in meeting regulatory requirements
- Higher voltage ratings allow use in new applications

Features:

- Broadest range of radial-leaded resettable devices available in the industry
- Current ratings from 50mA to 15A
- Voltage ratings from 6V (computer and electronic applications) to 265V_{AC} line voltage applications

- Agency recognition: UL, CSA, TÜV
- Fast time-to-trip
- Low resistance

Applications:

- Satellite video receivers
- Industrial controls
- Transformers
- Computer motherboards
- Modems
- USB hub, ports and peripherals
- IEEE1394 ports
- CD-ROMs
- Game machines
- Battery packs
- Phones
- Fax machines
- Analog and digital line cards
- Printers



Step 1. Determine the circuit’s operating parameters.

Fill in the following information about the circuit:

Maximum ambient operating temperature _____

Normal operating current _____

Maximum operating voltage
(i.e., RUE135 is 30V max.) _____

Maximum interrupt current _____

Step 2. Select the PolySwitch device that will accommodate the circuit’s maximum ambient temperature and normal operating current.

Look across the top of Table R2 to find the temperature that most closely matches the circuit’s maximum operating temperature. Look down that column to find the value equal to or greater than the circuit’s normal operating current. Now look to the far left of that row to find the part number for the PolySwitch device that will best accommodate the circuit. Devices in this section are grouped by voltage rating; therefore, your operating current requirement may be found in more than one product grouping.

The thermal derating curves located in Figures R1–R5 are the normalized representations of the data in Table R2.

Step 3. Compare the maximum electrical ratings of the selected device with the maximum operating voltage and maximum interrupt currents of the circuit.

Look down the first column of Table R3 to find the part number you selected in Step 2. Look to the right in that row to find the device’s maximum operating voltage (V_{MAX}) and maximum interrupt current (I_{MAX}). Ensure that V_{MAX} and I_{MAX} are greater than or equal to operating voltage and maximum interrupt current.

Step 4. Determine time-to-trip.

Time-to-trip is the amount of time it takes for a device to switch to a high-resistance state once a fault current has been applied across the device. Identifying the PolySwitch device's time-to-trip is important in order to provide the desired protection capabilities. If the device you choose trips too fast, undesired or nuisance tripping will occur. If the device trips too slowly, the components being protected may be damaged before the device switches to a high-resistance state.

Refer to the typical time-to-trip curves for each of the PolySwitch devices found in Figures R17–R23.

If the time-to-trip of the PolySwitch device is too fast or too slow for the circuit, go back to Step 2 and choose an alternate device.

Step 5. Verify ambient operating conditions.

Ensure that your application's minimum and maximum ambient temperatures are within the operating temperature of -40°C to 85°C (-40 to 125°C for RHE device series).

Step 6. Verify the PolySwitch device dimensions.

Using the dimensions in Table R4, compare the dimensions of the PolySwitch device you selected with the application's space considerations.

Protection Application Selection Guide for Radial-leaded Devices

The guide below lists PolySwitch devices that are typically used in these applications.

Specifications for the suggested device part numbers can be found in this section.

Once a part number has been selected, the user should evaluate and test each product for its intended application.

Protection Application	PolySwitch Resettable Devices—Key Selection Criteria		
	Small Size	Flatter Derating	Lower Current Higher Voltage
Electromagnetic loads	RGE (<16V), RUE (<30V)	RHE (<16V)	RXE (<72V)
Halogen lighting	RGE (<16V), RUE (<30V)	RHE (<16V)	RXE (<72V)
Lighting ballast	RXE (<72V), BBR (<99V _{AC})		LVR (<265V _{AC})
Loudspeakers	RXE (<72V)		RXE (<72V)
Medical equipment	RGE (<16V), RUE (<30V)	RHE (<16V)	RXE (<72V)
MOSFET devices	RGE (<16V), RUE (<30V)	RHE (<16V)	RXE (<72V)
Motors, fans, and blowers	RXE (<72V), RGE (<16V)	RHE (<16V)	LVR (<265V _{AC})
POS equipment	RXE (<72V), RUE (<30V)		
Process and industrial controls	RXE (<72V), RUE (<30V)		
Satellite video receivers	RGE (<16V), RUE (<30V)	RHE (<16V)	RXE (<72V)
Security and fire alarm systems	RGE (<16V), RUE (<30V)	RHE (<16V)	RXE (<72V), LVR (<265V _{AC})
Test and measurement equipment	RGE (<16V), RUE (<30V)	RHE (<16V)	RXE (<72V), LVR (<265V _{AC})
Transformers	RGE (<16V), RUE (<30V)	RHE (<16V)	RXE (<72V), LVR (<265V _{AC})
UL1950/FCC Part 68 requirements	RXE (<72V)		
DDC computer video ports	RUE (<30V)		
IEEE-1394 computer and consumer electronics	RTE (<33V)		
Mouse and keyboard	RUE (<30V)		
SCSI	RUE (<30V)		
USB	RUSB (<16V)		
Traces and printed circuit board protection	RGE (<16V), RUE (<30V)	RHE (<16V)	RXE (<72V)

This list is not exhaustive. Raychem Circuit Protection welcomes customer's input for additional application ideas for PolySwitch resettable devices.

Table R1. Product Series – Current Rating, Voltage Rating/Typical Resistance for Radial-led Devices

Voltage Rating	LVR 265V _{AC}	BBR 99V	TR600 60/600V*	TR250 60/250V*	RXE 72V	RXE 60V	RTE 33V	RUE 30V	RGE 16V	RHE 16V	RHE 30V	RUSB 16V	RUSB 6V
Hold Current (A)	—	—	—	—	—	—	—	—	—	—	—	—	—
0.050	25Ω	—	—	—	—	9.2Ω	—	—	—	—	—	—	—
0.080	9.8Ω	—	—	17.0Ω	—	—	—	—	—	—	—	—	—
0.100	—	—	—	—	—	3.50Ω	—	—	—	—	—	—	—
0.110	—	—	—	—	—	—	—	—	—	—	—	—	—
0.120	4.8Ω	—	—	6.0Ω	—	—	—	—	—	—	—	—	—
0.145	—	—	—	4.5Ω	—	—	—	—	—	—	—	—	—
0.150	—	—	9.0Ω	—	—	—	—	—	—	—	—	—	—
0.160	3.4Ω	—	7.0Ω	—	—	—	—	—	—	—	—	—	—
0.170	—	—	—	—	—	4.30Ω	—	—	—	—	—	—	—
0.180	—	—	—	1.4Ω	—	—	—	—	—	—	—	—	—
0.200	—	—	—	—	2.29Ω	—	—	—	—	—	—	—	—
0.250	1.7Ω	—	—	—	1.60Ω	—	—	—	—	—	—	—	—
0.300	—	—	—	—	1.11Ω	—	—	—	—	—	—	—	—
0.330	1.0Ω	—	—	—	—	—	—	—	—	—	—	—	—
0.400	0.80Ω	—	—	—	0.71Ω	—	—	—	—	—	—	—	—
0.500	—	—	—	—	0.64Ω	—	—	—	—	—	0.68Ω	—	—
0.550	—	1.05Ω	—	—	—	—	—	—	—	—	—	—	—
0.650	—	—	—	—	0.40Ω	—	—	—	—	—	—	—	—
0.700	—	—	—	—	—	—	—	—	—	—	0.42Ω	—	—
0.750	—	0.58Ω	—	—	0.325Ω	—	—	—	—	—	—	—	0.14Ω
0.900	—	—	—	—	0.255Ω	—	—	0.095Ω	—	—	—	0.10Ω	—
1.00	—	—	—	—	—	—	—	—	—	—	0.24Ω	—	—
1.10	—	—	—	—	0.200Ω	—	—	0.075Ω	—	—	—	0.075Ω	—
1.20	—	—	—	—	—	—	0.097Ω	—	—	—	—	—	0.080Ω
1.35	—	—	—	—	0.155Ω	—	0.080Ω	0.060Ω	—	—	—	0.060Ω	—
1.55	—	—	—	—	—	—	—	—	—	—	—	—	0.058Ω
1.60	—	—	—	—	0.115Ω	—	—	0.050Ω	—	—	—	0.050Ω	—
1.85	—	—	—	—	0.100Ω	—	—	0.045Ω	—	—	—	0.045Ω	—
1.90	—	—	—	—	—	—	0.054Ω	—	—	—	—	—	—
2.00	—	—	—	—	—	—	—	—	—	0.061Ω	—	—	—
2.50	—	—	—	—	0.065Ω	—	—	0.030Ω	0.038Ω	—	—	0.030Ω	—
3.00	—	—	—	—	0.050Ω	—	—	0.035Ω	0.0514Ω	—	—	—	—
3.75	—	—	—	—	0.040Ω	—	—	—	—	—	—	—	—
4.00	—	—	—	—	—	—	—	0.020Ω	0.030Ω	0.024Ω	—	—	—
4.50	—	—	—	—	—	—	—	—	—	0.029Ω	—	—	—
5.00	—	—	—	—	—	—	—	0.020Ω	0.0192Ω	—	—	—	—
6.00	—	—	—	—	—	—	—	0.013Ω	0.0145Ω	0.0175Ω	—	—	—
6.50	—	—	—	—	—	—	—	—	—	0.0144Ω	—	—	—
7.00	—	—	—	—	—	—	—	0.013Ω	0.0105Ω	—	—	—	—
7.50	—	—	—	—	—	—	—	—	—	0.012Ω	—	—	—
8.00	—	—	—	—	—	—	—	0.013Ω	0.0086Ω	—	—	—	—
9.00	—	—	—	—	—	—	—	0.008Ω	0.0070Ω	0.010Ω	—	—	—
10.0	—	—	—	—	—	—	—	—	0.0056Ω	0.0083Ω	—	—	—
11.0	—	—	—	—	—	—	—	—	0.0050Ω	—	—	—	—
12.0	—	—	—	—	—	—	—	—	0.0046Ω	—	—	—	—
13.0	—	—	—	—	—	—	—	—	—	0.0055Ω	—	—	—
14.0	—	—	—	—	—	—	—	—	0.0040Ω	—	—	—	—
15.0	—	—	—	—	—	—	—	—	—	0.0048Ω	—	—	—

*Refer to Telecommunications and Networking section for specific voltage rating information.

Table R2. Thermal Derating for Radial-leaded Devices [Hold Current (A) at Ambient Temperature (°C)]

Part Number	Maximum Ambient Temperature										
	-40°C	-20°C	0°C	20°C	25°C	40°C	50°C	60°C	70°C	85°C	125°C
LVR (Pb-free product)											
240V_{AC}											
New LVR005	—	0.08	0.06	0.05	0.05	0.04	0.04	0.03	0.03	0.02	—
New LVR008	—	0.12	0.10	0.08	0.08	0.07	0.06	0.05	0.04	0.03	—
New LVR012	—	0.18	0.15	0.12	0.12	0.10	0.09	0.07	0.06	0.04	—
New LVR016	—	0.24	0.20	0.16	0.16	0.13	0.11	0.10	0.08	0.05	—
New LVR025	—	0.38	0.32	0.26	0.25	0.21	0.18	0.15	0.13	0.09	—
New LVR033	—	0.50	0.42	0.34	0.33	0.27	0.23	0.20	0.17	0.11	—
New LVR040	—	0.61	0.51	0.41	0.40	0.33	0.28	0.24	0.20	0.14	—
New LVR055K	—	0.80	0.68	0.55	0.54	0.46	0.40	0.35	0.29	0.22	—
New LVR055S	—	0.80	0.68	0.55	0.54	0.46	0.40	0.35	0.29	0.22	—
BBR (BBRF for Pb-free version of product)											
99V_{AC}											
BBR550	0.85	0.75	0.65	0.55	—	0.45	0.40	0.35	0.3	0.22	—
BBR750	1.15	1.00	0.90	0.75	—	0.61	0.55	0.48	0.41	0.30	—
TR250, TR600											
60/600V For a complete selection of the TR series see the Telecommunications and Network section.											
TR250-080U	0.124	0.110	0.095	0.080	0.077	0.066	0.059	0.051	0.044	0.033	—
TR250-120	0.186	0.165	0.143	0.120	0.115	0.099	0.088	0.077	0.066	0.050	—
TR250-145	0.225	0.199	0.172	0.145	0.139	0.119	0.106	0.093	0.080	0.060	—
TRF250-180	0.269	0.240	0.211	0.180	0.173	0.153	0.138	0.123	0.109	0.087	—
TR600-150	0.233	0.206	0.178	0.150	0.143	0.124	0.110	0.096	0.083	0.062	—
TR600-160	0.249	0.219	0.190	0.160	0.153	0.132	0.117	0.103	0.088	0.066	—
RXE (RXEF for Pb-free version of product)											
60V											
RXE005	0.078	0.068	0.06	0.05	0.048	0.04	0.035	0.032	0.027	0.02	—
RXE010	0.16	0.14	0.11	0.10	0.096	0.08	0.072	0.067	0.05	0.04	—
RXE017	0.26	0.23	0.21	0.17	0.16	0.14	0.12	0.11	0.09	0.07	—
RXE (RXEF for Pb-free version of product)											
72V											
RXE020	0.31	0.27	0.24	0.20	0.19	0.16	0.14	0.13	0.11	0.08	—
RXE025	0.39	0.34	0.30	0.25	0.24	0.20	0.18	0.16	0.14	0.10	—
RXE030	0.47	0.41	0.36	0.30	0.29	0.24	0.22	0.20	0.16	0.12	—
RXE040	0.62	0.54	0.48	0.40	0.38	0.32	0.29	0.25	0.22	0.16	—
RXE050	0.78	0.68	0.60	0.50	0.48	0.41	0.36	0.32	0.27	0.20	—
RXE065	1.01	0.88	0.77	0.65	0.62	0.53	0.47	0.41	0.35	0.26	—
RXE075	1.16	1.02	0.89	0.75	0.72	0.61	0.54	0.47	0.41	0.30	—
RXE090	1.40	1.22	1.07	0.90	0.86	0.73	0.65	0.57	0.49	0.36	—
RXE110	1.71	1.50	1.31	1.10	1.06	0.89	0.79	0.69	0.59	0.44	—
RXE135	2.09	1.84	1.61	1.35	1.30	1.09	0.97	0.85	0.73	0.54	—
RXE160	2.48	2.18	1.90	1.60	1.54	1.30	1.15	1.01	0.86	0.64	—
RXE185	2.87	2.52	2.20	1.85	1.78	1.50	1.33	1.17	1.00	0.74	—
RXE250	3.88	3.40	2.98	2.50	2.40	2.03	1.80	1.58	1.35	1.00	—
RXE300	4.65	4.08	3.57	3.00	2.88	2.43	2.16	1.89	1.62	1.20	—
RXE375	5.81	5.10	4.46	3.75	3.60	3.04	2.70	2.36	2.03	1.50	—

Table R2. Thermal Derating for Radial-led Devices [Hold Current (A) at Ambient Temperature (°C)]
continued

Part Number	Maximum Ambient Temperature										
	-40°C	-20°C	0°C	20°C	25°C	40°C	50°C	60°C	70°C	85°C	125°C
RTE (RTEF for Pb-free version of product)											
33V											
RTE120	1.74	1.56	1.38	1.20	1.16	1.00	0.92	0.82	0.73	0.60	—
RTE135	1.96	1.76	1.55	1.35	1.31	1.12	1.04	0.92	0.82	0.68	—
RTE190	2.76	2.47	2.19	1.90	1.84	1.58	1.50	1.29	1.16	0.95	—
RUE (RUEF for Pb-free version of product)											
30V											
RUE090	1.31	1.17	1.04	0.90	0.87	0.75	0.69	0.61	0.55	0.47	—
RUE110	1.60	1.43	1.27	1.10	1.07	0.91	0.85	0.75	0.67	0.57	—
RUE135	1.96	1.76	1.55	1.35	1.31	1.12	1.04	0.92	0.82	0.70	—
RUE160	2.32	2.08	1.84	1.60	1.55	1.33	1.23	1.09	0.98	0.83	—
RUE185	2.68	2.41	2.13	1.85	1.79	1.54	1.42	1.26	1.13	0.96	—
RUE250	3.63	3.25	2.88	2.5	2.43	2.08	1.93	1.70	1.53	1.30	—
RUE300	4.35	3.90	3.45	3.0	2.91	2.49	2.31	2.04	1.83	1.56	—
RUE400	5.80	5.20	4.60	4.0	3.88	3.32	3.08	2.72	2.44	2.08	—
RUE500	7.25	6.50	5.75	5.0	4.85	4.15	3.85	3.40	3.05	2.60	—
RUE600	8.70	7.80	6.90	6.0	5.82	4.98	4.62	4.08	3.66	3.12	—
RUE700	10.15	9.10	8.05	7.0	6.79	5.81	5.39	4.76	4.27	3.64	—
RUE800	11.60	10.40	9.20	8.0	7.76	6.64	6.16	5.44	4.88	4.16	—
RUE900	13.05	11.70	10.35	9.0	8.73	7.47	6.93	6.12	5.49	4.68	—
RHE (RHEF for Pb-free version of product)											
30V - High Temperature											
New RHE050	0.68	0.62	0.56	0.51	0.5	0.44	0.40	0.36	0.34	0.28	0.12
New RHE070	0.95	0.87	0.79	0.72	0.7	0.62	0.56	0.51	0.47	0.39	0.17
New RHE100	1.36	1.24	1.13	1.03	1.00	0.89	0.80	0.73	0.67	0.56	0.24
RUSB (RUSBF for Pb-free version of product)											
16V											
RUSB090	1.31	1.17	1.04	0.90	0.87	0.75	0.69	0.61	0.55	0.47	—
RUSB110	1.60	1.43	1.27	1.10	1.07	1.00	0.92	0.75	0.67	0.57	—
RUSB135	1.96	1.76	1.55	1.35	1.31	1.12	1.04	0.92	0.82	0.70	—
RUSB160	2.32	2.08	1.84	1.60	1.55	1.33	1.23	1.09	0.98	0.83	—
RUSB185	2.68	2.41	2.13	1.85	1.79	1.54	1.42	1.26	1.13	0.96	—
RUSB250	3.63	3.25	2.88	2.50	2.43	2.08	1.93	1.70	1.53	1.30	—
RGE (RGEF for Pb-free version of product)											
16V											
New RGE250	3.7	3.3	3.0	2.6	2.5	2.2	2.0	1.3	1.6	1.2	—
RGE300	4.4	4.0	3.6	3.1	3.0	2.6	2.4	2.1	1.9	1.4	—
RGE400	5.9	5.3	4.8	4.1	4.0	3.5	3.2	2.8	2.5	1.9	—
RGE500	7.3	6.6	6.0	5.2	5.0	4.4	4.0	3.6	3.1	2.4	—
RGE600	8.8	8.0	7.2	6.2	6.0	5.2	4.8	4.2	3.8	2.8	—
RGE700	10.3	9.3	8.4	7.3	7.0	6.2	5.6	5.0	4.4	3.3	—
RGE800	11.7	10.7	9.6	8.3	8.0	6.9	6.4	5.6	5.1	3.7	—
RGE900	13.2	11.9	10.7	9.4	9.0	7.9	7.2	6.4	5.6	4.2	—
RGE1000	14.7	13.3	12.0	10.3	10.0	8.7	8.0	7.0	6.3	4.7	—
RGE1100	16.1	14.6	13.1	11.5	11.0	9.7	8.8	7.8	6.9	5.2	—
RGE1200	17.6	16.0	14.4	12.4	12.0	10.4	9.6	8.4	7.6	5.6	—
RGE1400	20.5	18.7	16.8	14.5	14.0	12.1	11.2	9.8	8.9	6.5	—

Table R2. Thermal Derating for Radial-led Devices [Hold Current (A) at Ambient Temperature (°C)]
continued

Part Number	Maximum Ambient Temperature										
	-40°C	-20°C	0°C	20°C	25°C	40°C	50°C	60°C	70°C	85°C	125°
RHE (RHEF for Pb-free version of product)											
16V - High Temperature											
New RHE200	2.71	2.49	2.26	2.06	2.00	1.77	1.60	1.46	1.34	1.11	0.99
RHE400	5.40	5.00	4.60	4.10	4.00	3.50	3.20	3.00	2.60	2.20	0.98
RHE450	6.10	5.60	5.10	4.60	4.50	4.00	3.60	3.30	3.00	2.50	1.10
RHE600	8.20	7.50	6.80	6.20	6.00	5.30	4.90	4.40	4.00	3.30	1.50
RHE650	8.80	8.10	7.40	6.70	6.50	5.70	5.30	4.80	4.30	3.60	1.60
RHE750	10.20	9.40	8.60	7.70	7.50	6.60	6.10	5.60	5.00	4.10	1.90
New RHE900	12.21	11.19	10.16	9.26	9.00	7.97	7.20	6.56	6.04	5.01	2.19
RHE1000	13.60	12.50	11.40	10.30	10.00	8.80	8.10	7.40	6.60	5.50	2.50
RHE1300	17.70	16.30	14.80	13.40	13.00	11.40	10.50	9.60	8.60	7.20	3.30
RHE1500	20.40	18.80	17.10	15.50	15.00	13.20	12.10	11.10	9.90	8.30	3.80
RUSB (RUSBF for Pb-free version of product)											
6V											
RUSB075	1.05	0.95	0.85	0.75	0.73	0.65	0.60	0.55	0.50	0.43	—
RUSB120	1.69	1.52	1.36	1.20	1.16	1.04	0.96	0.88	0.80	0.68	—
RUSB155	2.17	1.96	1.75	1.55	1.50	1.34	1.24	1.14	1.03	0.88	—

4

Figures R1–R5. Thermal Derating Curves for Radial-led Devices

LVR

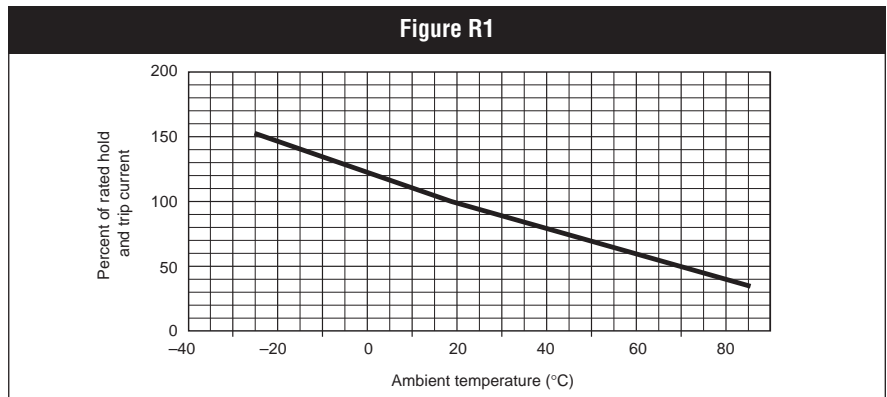

RXE/RXEF and
BBR/BBRF

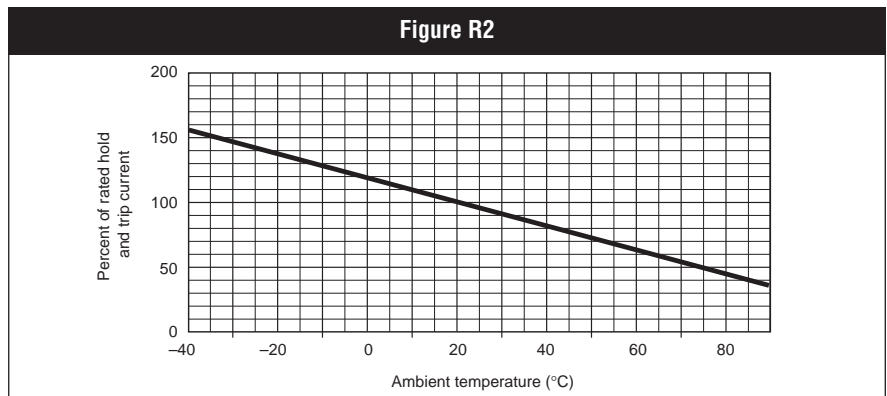

Figures R1–R5. Thermal Derating Curve for Radial-led Devices *continued*

A = RUSB075/RUSBF075,
RUSB120/RUSBF120 and
RUSB155/RUSBF155
devices

B = RUE/RUEF, RTE/RTEF,
and all other
RUSB/RUSBF devices

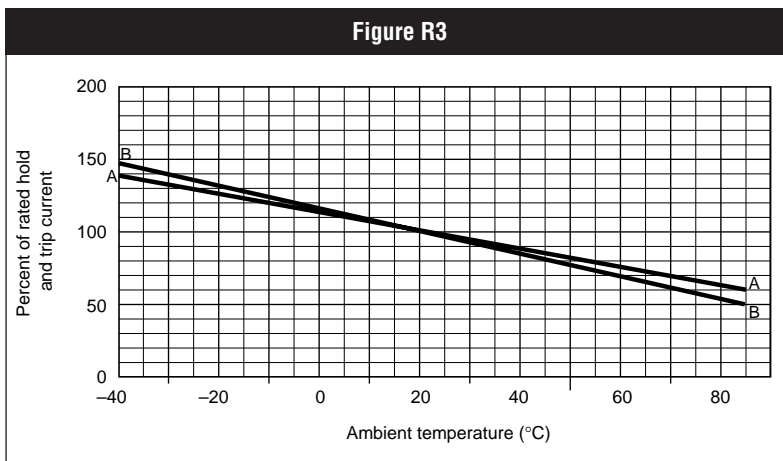

RHE/RHEF

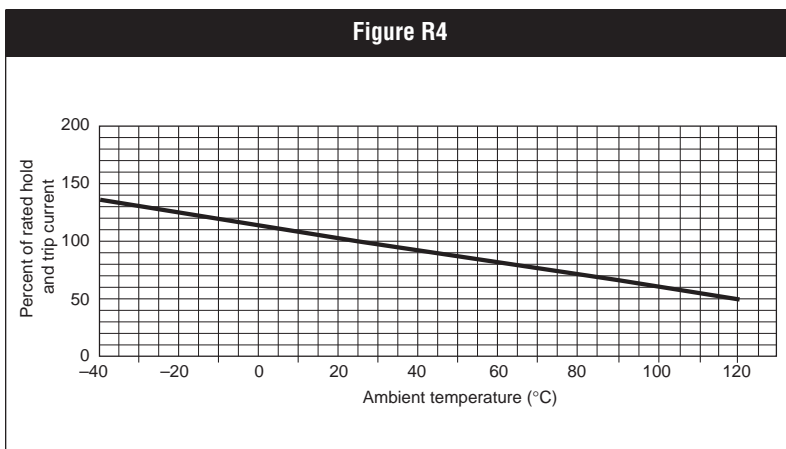

4

RGE/RGEF

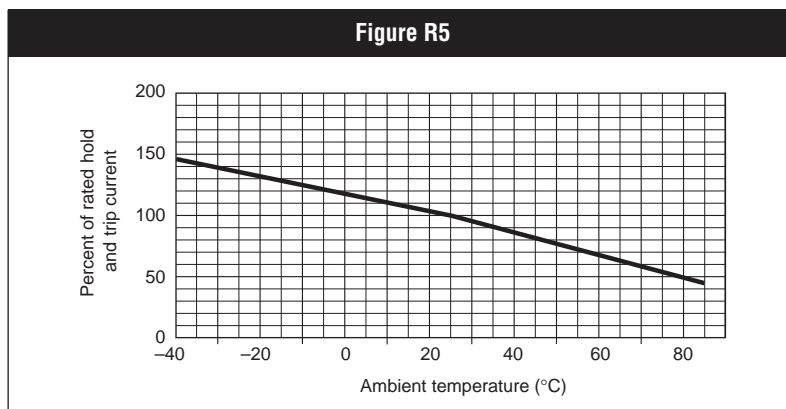

For thermal derating of all TR series see the Telecommunications and Networking section.

Table R3. Electrical Characteristics for Radial-led Devices

Part Number	I _H (A)	I _T (A)	V _{MAX} (V)	V _{MAX} Interrupt (V _{AC})	I _{MAX} (A)	P _D TYP (W)	Max. Time-to-trip (s)	R _{MIN} (Ω)	R _{MAX} (Ω)	R ₁ MAX (Ω)	Figures for Dimensions	Lead Size [mm ² (AWG)]	
LVR (Pb-free product)													
240V_{AC}													
LVR005K	0.05	0.12	240	265	1.0	0.7	0.25	15	18.5	31.0	65.0	R7	[0.205mm ² (24)]
LVR005S	0.05	0.12	240	265	1.0	0.7	0.25	15	18.5	31.0	65.0	R7	[0.205mm ² (24)]
LVR008K	0.08	0.19	240	265	1.2	0.8	0.4	15	7.4	12.0	26.0	R7	[0.205mm ² (24)]
LVR008S	0.08	0.19	240	265	1.2	0.8	0.4	15	7.4	12.0	26.0	R7	[0.205mm ² (24)]
LVR012K	0.12	0.30	240	265	1.2	1.0	0.6	15	3.0	6.5	12.0	R7	[0.205mm ² (24)]
LVR012S	0.12	0.30	240	265	1.2	1.0	0.6	15	3.0	6.5	12.0	R7	[0.205mm ² (24)]
LVR016K	0.16	0.37	240	265	2.0	1.4	0.8	15	2.5	4.1	7.8	R7	[0.205mm ² (24)]
LVR016S	0.16	0.37	240	265	2.0	1.4	0.8	15	2.5	4.1	7.8	R7	[0.205mm ² (24)]
LVR025K	0.25	0.56	240	265	3.5	1.5	1.25	18.5	1.3	2.1	3.8	R8	[0.33mm ² (22)]
LVR025S	0.25	0.56	240	265	3.5	1.5	1.25	18.5	1.3	2.1	3.8	R8	[0.33mm ² (22)]
LVR033S	0.33	0.74	240	265	4.5	1.7	1.25	18.5	0.83	1.24	2.6	R8	[0.33mm ² (22)]
LVR033K	0.33	0.74	240	265	4.5	1.7	1.25	18.5	0.83	1.24	2.6	R8	[0.33mm ² (22)]
LVR040K	0.40	0.90	240	265	5.5	2.0	2.0	24.0	0.6	0.97	1.9	R8	[0.33mm ² (22)]
LVR040S	0.40	0.90	240	265	5.5	2.0	2.0	24.0	0.6	0.97	1.9	R8	[0.33mm ² (22)]
LVR055K	0.55	1.25	240	265	7.0	3.4	2.75	26.0	0.45	0.73	1.45	R8	[0.52mm ² (20)]
LVR055S	0.55	1.25	240	265	7.0	3.4	2.75	26.0	0.45	0.73	1.45	R8	[0.52mm ² (20)]
BBR (BBRF for Pb-free version of product)													
99V_{AC}													
BBR550	0.55	1.1	99	—	20	1.5	1.6	60	0.8	1.3	1.95	R6, R15, R16	[0.52mm ² (20)]
BBR750	0.75	1.5	99	—	20	1.7	2.0	60	0.40	0.75	1.2	R6, R15, R16	[0.52mm ² (20)]
TR250, TR600													
60/600V Product For a complete selection of the TR devices, see the Telecommunications and Networking section.													
TR250-080U	0.080	0.160	60	250	3.0	1.0	0.35	3.0	14.0	20.0	33.0	R7	[0.33mm ² (22)]
TR250-120	0.120	0.240	60	250	3.0	1.0	1.0	1.5*	4.0	8.0	16.0	R8	[0.33mm ² (22)]
TR250-145	0.145	0.290	60	250	3.0	1.0	1.0	2.5*	3.0	6.0	14.0	R8	[0.33mm ² (22)]
TR250-180U	0.180	0.360	60	250	10.0	1.0	1.0	12.0*	0.8	2.0	4.0	R8	[0.33mm ² (22)]
TR600-150	0.150	0.300	60	250	3.0	1.0	1.0	5.0*	6.0	12.0	22.0	R8	[0.33mm ² (22)]
TR600-160	0.160	0.320	60	250	3.0	1.0	1.0	7.0*	4.0	10.0	18.0	R8	[0.33mm ² (22)]
*Time-to-trip value is typical.													
RXE (RXEF for Pb-free version of product)													
60V													
RXE005	0.05	0.10	60	—	40	0.26	0.25	5.0	7.3	11.10	20.0	R9, R15, R16	[0.128mm ² (26)]
RXE010	0.10	0.20	60	—	40	0.38	0.50	4.0	2.5	4.50	7.5	R10, R15, R16	[0.205mm ² (24)]
RXE017	0.17	0.34	60	—	40	0.48	0.85	3.0	3.3	5.21	8.0	R10, R15, R16	[0.205mm ² (24)]
RXE (RXEF for Pb-free version of product)													
72V													
RXE020	0.20	0.40	72	—	40	0.41	1.00	2.2	1.83	2.75	4.40	R10, R15, R16	[0.205mm ² (24)]
RXE025	0.25	0.50	72	—	40	0.45	1.25	2.5	1.25	1.95	3.00	R10, R15, R16	[0.205mm ² (24)]
RXE030	0.30	0.60	72	—	40	0.49	1.50	3.0	0.88	1.33	2.10	R10, R15, R16	[0.205mm ² (24)]
RXE040	0.40	0.80	72	—	40	0.56	2.00	3.8	0.55	0.86	1.29	R10, R15, R16	[0.205mm ² (24)]
RXE050	0.50	1.00	72	—	40	0.77	2.50	4.0	0.50	0.77	1.17	R10, R15, R16	[0.205mm ² (24)]
RXE065	0.65	1.30	72	—	40	0.88	3.25	5.3	0.31	0.48	0.72	R10, R15, R16	[0.205mm ² (24)]
RXE075	0.75	1.50	72	—	40	0.92	3.75	6.3	0.25	0.40	0.60	R10, R15, R16	[0.205mm ² (24)]
RXE090	0.90	1.80	72	—	40	0.99	4.50	7.2	0.20	0.31	0.47	R10, R15, R16	[0.205mm ² (24)]
RXE110	1.10	2.20	72	—	40	1.50	5.50	8.2	0.15	0.25	0.38	R11, R15, R16	[0.52mm ² (20)]
RXE135	1.35	2.70	72	—	40	1.70	6.75	9.6	0.12	0.19	0.30	R11, R15, R16	[0.52mm ² (20)]
RXE160	1.60	3.20	72	—	40	1.90	8.00	11.4	0.09	0.14	0.22	R11, R15, R16	[0.52mm ² (20)]
RXE185	1.85	3.70	72	—	40	2.10	9.25	12.6	0.08	0.12	0.19	R11, R15, R16	[0.52mm ² (20)]
RXE250	2.50	5.00	72	—	40	2.50	12.50	15.6	0.05	0.08	0.13	R11, R15, R16	[0.52mm ² (20)]
RXE300	3.00	6.00	72	—	40	2.80	15.00	19.8	0.04	0.06	0.10	R11, R15, R16	[0.52mm ² (20)]
RXE375	3.75	7.50	72	—	40	3.20	18.75	24.0	0.03	0.05	0.08	R11, R15, R16	[0.52mm ² (20)]

Table R3. Electrical Characteristics for Radial-led Devices *continued*

Part Number	I _H (A)	I _T (A)	V _{MAX} (V)	V _{MAX} Interrupt (V _{RMS})	I _{MAX} (A)	P _D TYP (W)	Max. Time-to-trip		R _{MIN} (Ω)	R _{MAX} (Ω)	R _{1,MAX} (Ω)	Figures for Dimensions	Lead Size [mm ² (AWG)]	
							(A)	(s)						
RTE (RTEF for Pb-free version of product)														
33V														
RTE120	1.20	2.3	33	—	40	0.78	6.0	3.5	0.074	0.12	0.18	R12, R15, R16	[0.205mm ² (24)]	
RTE135	1.35	2.5	33	—	40	0.84	6.75	4.5	0.059	0.10	0.143	R12, R15, R16	[0.205mm ² (24)]	
RTE190	1.90	3.0	33	—	40	0.90	9.5	3.5	0.045	0.063	0.092	R12, R15, R16	[0.205mm ² (24)]	
RUE (RUEF for Pb-free version of product)														
30V														
RUE090	0.90	1.8	30	—	40	0.6	4.5	5.9	0.070	0.12	0.22	R12, R15, R16	[0.205mm ² (24)]	
RUE110	1.10	2.2	30	—	40	0.7	5.5	6.6	0.050	0.10	0.17	R12, R15, R16	[0.205mm ² (24)]	
RUE135	1.35	2.7	30	—	40	0.8	6.75	7.3	0.040	0.08	0.13	R12, R15, R16	[0.205mm ² (24)]	
RUE160	1.60	3.2	30	—	40	0.9	8.5	8.0	0.030	0.07	0.11	R12, R15, R16	[0.205mm ² (24)]	
RUE185	1.85	3.7	30	—	40	1.0	9.25	8.7	0.030	0.06	0.09	R12, R15, R16	[0.205mm ² (24)]	
RUE250	2.5	5.0	30	—	40	1.2	12.5	10.3	0.020	0.04	0.07	R12, R15, R16	[0.205mm ² (24)]	
RUE300	3.0	6.0	30	—	40	2.0	15.0	10.8	0.020	0.05	0.08	R13, R15, R16	[0.52mm ² (20)]	
RUE400	4.0	8.0	30	—	40	2.5	20.0	12.7	0.010	0.03	0.05	R13, R15, R16	[0.52mm ² (20)]	
RUE500	5.0	10.0	30	—	40	3.0	25.0	14.5	0.010	0.03	0.05	R13, R15, R16	[0.52mm ² (20)]	
RUE600	6.0	12.0	30	—	40	3.5	30.0	16.0	0.005	0.02	0.04	R13, R15, R16	[0.52mm ² (20)]	
RUE700	7.0	14.0	30	—	40	3.8	35.0	17.5	0.005	0.02	0.03	R13, R15, R16	[0.52mm ² (20)]	
RUE800	8.0	16.0	30	—	40	4.0	40.0	18.8	0.005	0.013	0.02	R13, R15, R16	[0.52mm ² (20)]	
RUE900	9.0	18.0	30	—	40	4.2	45.0	20.0	0.005	0.01	0.02	R13, R15, R16	[0.52mm ² (20)]	
RHE (RHEF for Pb-free version of product)														
30V - High Temperature														
New	RHE050†	0.50	0.90	30	—	40	0.9	2.5	2.5	0.48	0.79	1.1	R10, R15, R16	[0.205mm ² (24)]
New	RHE070†	0.7	1.4	16	—	40	1.4	3.5	4.0	0.30	0.54	0.8	R12, R15, R16	[0.205mm ² (24)]
New	RHE100†	1.0	1.8	30	—	40	1.4	5.0	5.2	0.18	0.31	0.43	R10, R15, R16	[0.205mm ² (24)]
RUSB (RUSBF for Pb-free version of product)														
16V														
RUSB090	0.90	1.8	16	—	40	0.6	8.0	1.2	0.070	0.120	0.180	R12, R15, R16	[0.205mm ² (24)]	
RUSB110	1.10	2.2	16	—	40	0.7	8.0	2.3	0.050	0.095	0.140	R12, R15, R16	[0.205mm ² (24)]	
RUSB135	1.35	2.7	16	—	40	0.8	8.0	4.5	0.040	0.074	0.115	R12, R15, R16	[0.205mm ² (24)]	
RUSB160	1.60	3.2	16	—	40	0.9	8.0	9.0	0.030	0.061	0.110	R12, R15, R16	[0.205mm ² (24)]	
RUSB185	1.85	3.7	16	—	40	1.0	8.0	10.0	0.030	0.051	0.090	R12, R15, R16	[0.205mm ² (24)]	
RUSB250	2.5	5.0	16	—	40	1.2	8.0	40.0	0.020	0.036	0.060	R12, R15, R16	[0.205mm ² (24)]	
RGE (RGEF for Pb-free version of product)														
16V														
New	RGE250†	2.5	4.7	16	—	100	1.0	12.5	5.0	0.022	0.035	0.053	R12, R15, R16	[0.205mm ² (24)]
RGE300†	3.0	5.1	16	—	100	2.3	15.0	1.0	0.038	0.0645	0.0975	R13, R15, R16	[0.52mm ² (20)]	
RGE400†	4.0	6.8	16	—	100	2.4	20.0	1.7	0.021	0.0385	0.0600	R13, R15, R16	[0.52mm ² (20)]	
RGE500†	5.0	8.5	16	—	100	2.6	25.0	2.0	0.015	0.0230	0.0340	R13, R15, R16	[0.52mm ² (20)]	
RGE600†	6.0	10.2	16	—	100	2.8	30.0	3.3	0.010	0.0185	0.0280	R13, R15, R16	[0.52mm ² (20)]	
RGE700†	7.0	11.9	16	—	100	3.0	35.0	3.5	0.0077	0.0130	0.0200	R13, R15, R16	[0.52mm ² (20)]	
RGE800†	8.0	13.6	16	—	100	3.0	40.0	5.0	0.0056	0.0110	0.0175	R13, R15, R16	[0.52mm ² (20)]	
RGE900†	9.0	15.3	16	—	100	3.3	45.0	5.5	0.0047	0.0092	0.0135	R13, R15, R16	[0.52mm ² (20)]	
RGE1000†	10.0	17.0	16	—	100	3.6	50.0	6.0	0.0040	0.0071	0.0102	R13, R15, R16	[0.52mm ² (20)]	
RGE1100†	11.0	18.7	16	—	100	3.7	55.0	7.0	0.0037	0.0062	0.0089	R13, R15, R16	[0.52mm ² (20)]	
RGE1200†	12.0	20.4	16	—	100	4.2	60.0	7.5	0.0033	0.00595	0.0086	R13, R15, R16	[0.823mm ² (18)]	
RGE1400†	14.0	23.8	16	—	100	4.6	70.0	9.0	0.0026	0.00445	0.0064	R13, R15, R16	[0.823mm ² (18)]	

†Electrical characteristics determined at 25°C.

Table R3. Electrical Characteristics for Radial-led Devices *continued*

Part Number	I_H (A)	I_T (A)	V_{MAX} (V)	V_{MAX} Interrupt (V_{AC})	I_{MAX} (A)	$P_{D\ TYP}$ (W)	Max. Time-to-trip		R_{MIN} (Ω)	R_{MAX} (Ω)	$R_{1\ MAX}$ (Ω)	Figures for Dimensions	Lead Size [mm ² (AWG)]
							(A)	(s)					
RHE High Temperature (RHEF for Pb-free version of product)													
16V													
New RHE200†	2.0	3.8	16	—	100	1.4	12.5	3.0	0.045	0.074	0.11	R10, R15, R16	[0.205mm ² (24)]
RHE400†	4.0	7.0	16	—	100	2.0	20.0	8.0	0.018	0.029	0.044	R14, R15, R16	[0.205mm ² (24)]
RHE450†	4.5	7.8	16	—	100	3.6	22.5	3.0	0.022	0.0355	0.054	R14, R15, R16	[0.579mm ² (20)]
RHE600†	6.0	10.8	16	—	100	4.1	30.0	5.0	0.013	0.0215	0.032	R14, R15, R16	[0.579mm ² (20)]
RHE650†	6.5	12.0	16	—	100	4.3	32.5	5.5	0.011	0.0175	0.026	R14, R15, R16	[0.579mm ² (20)]
RHE750†	7.5	13.1	16	—	100	4.5	37.5	7.0	0.0094	0.0150	0.022	R14, R15, R16	[0.579mm ² (20)]
New RHE900†	9.0	16.5	16	—	100	5.0	45	10.0	0.0074	0.0120	0.017	R14, R15, R16	[0.579mm ² (20)]
RHE1000†	10.0	18.5	16	—	100	5.3	50.0	9.0	0.0062	0.0103	0.015	R14, R15, R16	[0.579mm ² (20)]
RHE1300†	13.0	24.0	16	—	100	6.9	65.0	13.0	0.0041	0.0068	0.010	R14, R15, R16	[0.823mm ² (18)]
RHE1500†	15.0	28.0	16	—	100	7.0	75.0	20.0	0.0032	0.0063	0.0092	R14, R15, R16	[0.823mm ² (18)]

RUSB (RUSBF for Pb-free version of product)

6V													
RUSB075	0.75	1.30	6	—	40	0.3	8.0	0.4	0.110	0.175	0.23	R10, R15, R16	[0.205mm ² (24)]
RUSB120	1.20	2.00	6	—	40	0.6	8.0	0.5	0.065	0.0975	0.14	R10, R15, R16	[0.205mm ² (24)]
RUSB155	1.55	2.65	6	—	40	0.6	8.0	0.5	0.043	0.0705	0.10	R10, R15, R16	[0.205mm ² (24)]

Notes:

I_H = Hold current: maximum current device will pass without interruption in 20°C still air.

I_T = Trip current: minimum current that will switch the device from low resistance to high resistance in 20°C still air.

R_{MIN} = Minimum resistance of device as supplied at 20°C unless otherwise specified.

R_{MAX} = Maximum resistance of device as supplied at 20°C unless otherwise specified.

V_{MAX} = Maximum continuous voltage device can withstand without damage at rated current.

V_{MAX} Interrupt = Under specified conditions this is the highest voltage that can be applied to the device at the maximum current.

I_{MAX} = Maximum fault current device can withstand without damage at rated voltage.

P_D = Power dissipated from device when in the tripped state in 20°C still air.

$R_{1\ MAX}$ = Maximum resistance of device when measured one hour post reflow (surface-mount device) or one hour post trip (radial leaded device) at 20°C unless otherwise specified.

†Electrical characteristics determined at 25°C.



Figures R6–R16. Physical Description for Dimensions for Radial-led Devices

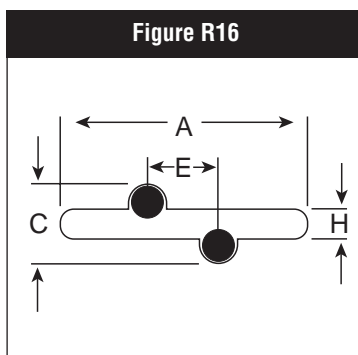
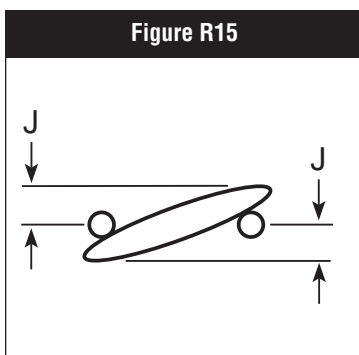
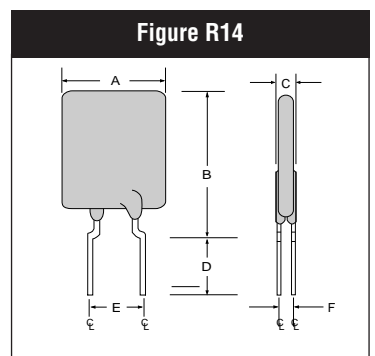
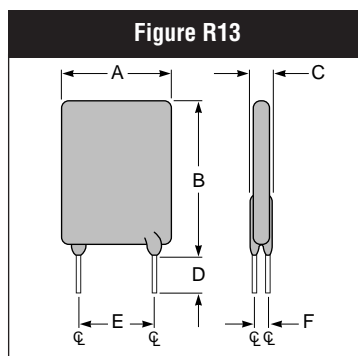
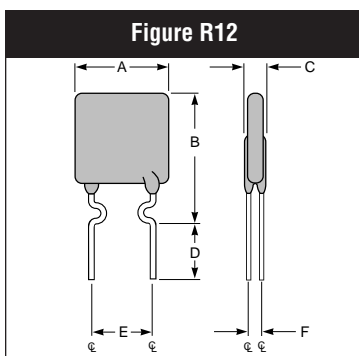
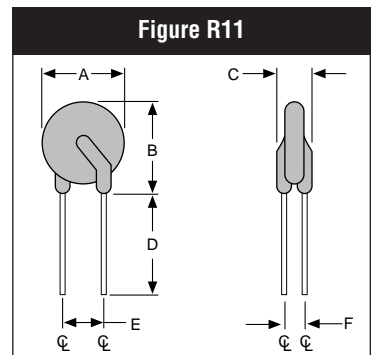
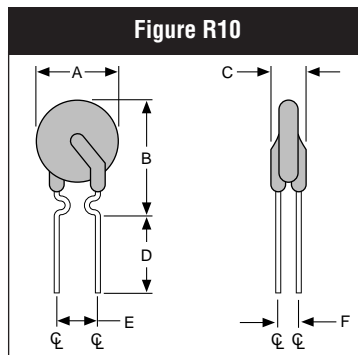
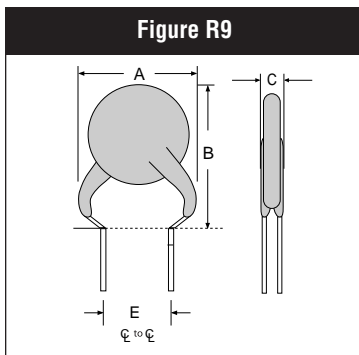
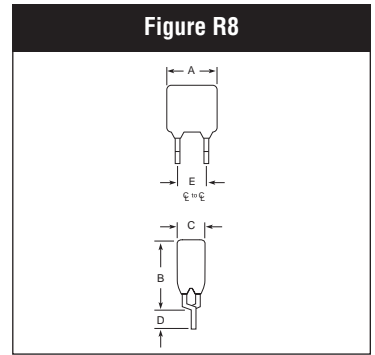
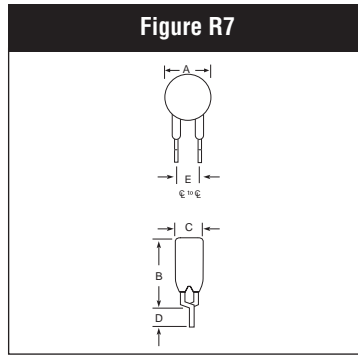
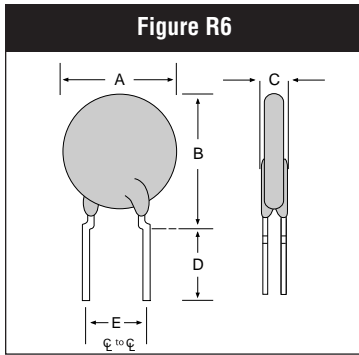

4

Table R4. Dimensions for Radial-led Devices in Millimeters (Inches)

Part Number	Dimension												Figures	
	A		B		C		D		E		F	H		J
	Min.	Max.	Min.	Max.	Min.	Max.	Min.	Max.	Min.	Max.	Typ.	Typ.		Typ.
LVR														
240V														
LVR005K	—	8.3 (0.33)	—	12.9 (0.51)	—	3.8 (0.15)	7.6 (0.30)	—	4.3 (0.17)	5.8 (0.23)	—	—	—	R7
LVR005S	—	8.3 (0.33)	—	10.7 (0.43)	—	3.8 (0.15)	7.6 (0.30)	—	4.3 (0.17)	5.8 (0.23)	—	—	—	R7
LVR008K	—	8.3 (0.33)	—	12.9 (0.51)	—	3.8 (0.15)	7.6 (0.30)	—	4.3 (0.17)	5.8 (0.23)	—	—	—	R7
LVR008S	—	8.3 (0.33)	—	10.7 (0.43)	—	3.8 (0.15)	7.6 (0.30)	—	4.3 (0.17)	5.8 (0.23)	—	—	—	R7
LVR012K	—	8.3 (0.33)	—	12.9 (0.51)	—	3.8 (0.15)	7.6 (0.30)	—	4.3 (0.17)	5.8 (0.23)	—	—	—	R7
LVR012S	—	8.3 (0.33)	—	10.7 (0.43)	—	3.8 (0.15)	7.6 (0.30)	—	4.3 (0.17)	5.8 (0.23)	—	—	—	—
LVR016K	—	9.9 (0.39)	—	13.8 (0.54)	—	3.8 (0.15)	7.6 (0.30)	—	4.3 (0.17)	5.8 (0.23)	—	—	—	R7
LVR016S	—	9.9 (0.39)	—	12.5 (0.50)	—	3.8 (0.15)	7.6 (0.30)	—	4.3 (0.17)	5.8 (0.23)	—	—	—	R7
LVR025K	—	9.6 (0.38)	—	18.8 (0.74)	—	3.8 (0.15)	7.6 (0.30)	—	4.3 (0.17)	5.8 (0.23)	—	—	—	R8
LVR025S	—	9.6 (0.38)	—	17.4 (0.69)	—	3.8 (0.15)	7.6 (0.30)	—	4.3 (0.17)	5.8 (0.23)	—	—	—	R8
LVR033S	—	11.4 (0.45)	—	16.5 (0.65)	4.3 (0.17)	5.8 (0.23)	7.6 (0.30)	—	—	3.8 (0.15)	—	—	—	R8
LVR033K	—	11.4 (0.45)	—	19.0 (0.75)	4.3 (0.17)	5.8 (0.23)	7.6 (0.30)	—	—	3.8 (0.15)	—	—	—	R8
LVR040K	—	11.5 (0.46)	—	20.9 (0.82)	—	3.8 (0.15)	7.6 (0.30)	—	4.3 (0.17)	5.8 (0.23)	—	—	—	R8
LVR040S	—	11.5 (0.46)	—	19.5 (0.77)	—	3.8 (0.15)	7.6 (0.30)	—	4.3 (0.17)	5.8 (0.23)	—	—	—	R8
LVR055K	—	14.0 (0.55)	—	21.7 (0.85)	—	5.8 (0.23)	7.6 (0.30)	—	2.0 (0.08)	3.0 (0.12)	—	—	—	R8
LVR055S	—	14.0 (0.55)	—	21.7 (0.85)	—	5.8 (0.23)	7.6 (0.30)	—	—	3.8 (0.15)	—	—	—	R8
BBR														
99V														
BBR550	—	10.9 (0.43)	—	14.0 (0.55)	—	3.6 (0.14)	7.6 (0.3)	—	4.3 (0.17)	5.8 (0.23)	—	1.37 (0.054)	1.2 (0.05)	R6, R15, R16
BBR750	—	11.9 (0.47)	—	15.5 (0.61)	—	3.6 (0.14)	7.6 (0.3)	—	4.3 (0.17)	5.8 (0.23)	—	1.37 (0.054)	1.2 (0.05)	R6, R15, R16
TR250, TR600														
60/600V														
TR250-080U	—	4.8 (0.189)	—	9.3 (0.366)	—	3.8 (0.15)	4.7 (0.185)	—	5.00* (0.197)	—	—	—	—	R7
TR250-120	—	6.5 (0.256)	—	11.0 (0.433)	—	4.6 (0.180)	4.7 (0.185)	—	5.00 (0.197)	—	—	—	—	R8
TR250-145	—	6.5 (0.256)	—	11.0 (0.433)	—	4.6 (0.180)	4.7 (0.185)	—	5.00* (0.197)	—	—	—	—	R8
TR250-180U	—	10.4 (0.410)	—	12.6 (0.495)	—	3.6 (0.140)	4.7 (0.185)	—	5.00* (0.197)	—	—	—	—	R8
TR600-150	—	13.5 (0.531)	—	12.6 (0.495)	—	6.0 (0.236)	4.7 (0.185)	—	5.00* (0.197)	—	—	—	—	R8
TR600-160	—	16.0 (0.630)	—	12.6 (0.495)	—	6.0 (0.236)	4.7 (0.185)	—	5.00* (0.197)	—	—	—	—	R8

*Indicates dimension is typical, not minimum.



Table R4. Dimensions for Radial-led Devices in Millimeters (Inches) *continued*

Part Number	Dimension													Figures
	A		B		C		D		E		F	H	J	
	Min.	Max.	Min.	Max.	Min.	Max.	Min.	Max.	Min.	Max.	Typ.	Typ.	Typ.	
RXE														
60V														
RXE005		8.0 (0.32)		8.3 (0.33)	—	3.0 (0.12)	7.6 (0.30)	—	4.3 (0.17)	5.8 (0.23)	—	1.07 (0.04)	1.0 (0.04)	R9, R15, R16
RXE010	—	7.4 (0.29)	—	11.6 (0.46)	—	3.0 (0.12)	7.6 (0.30)	—	4.3 (0.17)	5.8 (0.23)	—	1.07 (0.042)	1.0 (0.04)	R10, R15, R16
RXE017	—	7.4 (0.29)	—	11.6 (0.46)	—	3.0 (0.12)	7.6 (0.30)	—	4.3 (0.17)	5.8 (0.23)	—	1.68 (0.066)	1.7 (0.07)	R10, R15, R16
RXE														
72V														
RXE020	—	7.4 (0.29)	—	11.7 (0.46)	—	3.0 (0.12)	7.6 (0.30)	—	4.3 (0.17)	5.8 (0.23)	—	1.17 (0.046)	1.0 (0.04)	R10, R15, R16
RXE025	—	7.4 (0.29)	—	12.7 (0.50)	—	3.0 (0.12)	7.6 (0.30)	—	4.3 (0.17)	5.8 (0.23)	—	1.17 (0.046)	1.0 (0.04)	R10, R15, R16
RXE030	—	7.4 (0.29)	—	12.7 (0.50)	—	3.0 (0.12)	7.6 (0.30)	—	4.3 (0.17)	5.8 (0.23)	—	1.17 (0.046)	1.0 (0.04)	R10, R15, R16
RXE040	—	7.6 (0.30)	—	13.5 (0.53)	—	3.0 (0.12)	7.6 (0.30)	—	4.3 (0.17)	5.8 (0.23)	—	1.17 (0.046)	1.2 (0.05)	R10, R15, R16
RXE050	—	7.9 (0.31)	—	13.7 (0.54)	—	3.0 (0.12)	7.6 (0.30)	—	4.3 (0.17)	5.8 (0.23)	—	1.17 (0.046)	1.2 (0.05)	R10, R15, R16
RXE065	—	9.4 (0.37)	—	14.5 (0.57)	—	3.0 (0.12)	7.6 (0.30)	—	4.3 (0.17)	5.8 (0.23)	—	1.17 (0.046)	1.5 (0.06)	R10, R15, R16
RXE075	—	10.2 (0.40)	—	15.2 (0.60)	—	3.0 (0.12)	7.6 (0.30)	—	4.3 (0.17)	5.8 (0.23)	—	1.17 (0.046)	1.5 (0.06)	R10, R15, R16
RXE090	—	11.2 (0.44)	—	15.8 (0.62)	—	3.0 (0.12)	7.6 (0.30)	—	4.3 (0.17)	5.8 (0.23)	—	1.17 (0.046)	1.5 (0.06)	R10, R15, R16
RXE110	—	12.8 (0.50)	—	17.5 (0.69)	—	3.0 (0.12)	7.6 (0.30)	—	4.3 (0.17)	5.8 (0.23)	—	1.37 (0.054)	1.2 (0.05)	R11, R15, R16
RXE135	—	14.5 (0.57)	—	19.1 (0.75)	—	3.0 (0.12)	7.6 (0.30)	—	4.3 (0.17)	5.8 (0.23)	—	1.37 (0.054)	1.2 (0.05)	R11, R15, R16
RXE160	—	16.3 (0.64)	—	20.8 (0.82)	—	3.0 (0.12)	7.6 (0.30)	—	4.3 (0.17)	5.8 (0.23)	—	1.37 (0.054)	1.5 (0.06)	R11, R15, R16
RXE185	—	17.5 (0.69)	—	22.4 (0.88)	—	3.0 (0.12)	7.6 (0.30)	—	4.3 (0.17)	5.8 (0.23)	—	1.37 (0.054)	1.5 (0.06)	R11, R15, R16
RXE250	—	20.8 (0.82)	—	25.4 (1.00)	—	3.0 (0.12)	7.6 (0.30)	—	9.4 (0.37)	10.9 (0.43)	—	1.37 (0.054)	1.7 (0.07)	R11, R15, R16
RXE300	—	23.9 (0.94)	—	28.6 (1.13)	—	3.0 (0.12)	7.6 (0.30)	—	9.4 (0.37)	10.9 (0.43)	—	1.37 (0.054)	1.7 (0.07)	R11, R15, R16
RXE375	—	27.2 (1.07)	—	31.8 (1.25)	—	3.0 (0.12)	7.6 (0.30)	—	9.4 (0.37)	10.9 (0.43)	—	1.37 (0.054)	1.7 (0.07)	R11, R15, R16
RTE														
33V														
RTE120	—	7.4 (0.29)	—	12.2 (0.48)	—	3.0 (0.12)	7.6 (0.30)	—	4.3 (0.17)	5.8 (0.23)	—	0.89 (0.035)	0.8 (0.03)	R12, R15, R16
RTE135	—	7.4 (0.29)	—	14.2 (0.56)	—	3.0 (0.12)	7.6 (0.30)	—	4.3 (0.17)	5.8 (0.23)	—	0.89 (0.035)	0.8 (0.03)	R12, R15, R16
RTE190	—	8.9 (0.35)	—	13.5 (0.53)	—	3.0 (0.12)	7.6 (0.30)	—	4.3 (0.17)	5.8 (0.23)	—	0.89 (0.035)	1.0 (0.04)	R12, R15, R16
RUE														
30V														
RUE090	—	7.4 (0.29)	—	12.2 (0.48)	—	3.0 (0.12)	7.6 (0.30)	—	4.3 (0.17)	5.8 (0.23)	—	0.89 (0.035)	0.8 (0.03)	R12, R15, R16
RUE110	—	7.4 (0.29)	—	14.2 (0.56)	—	3.0 (0.12)	7.6 (0.30)	—	4.3 (0.17)	5.8 (0.23)	—	0.89 (0.035)	0.8 (0.03)	R12, R15, R16
RUE135	—	8.9 (0.35)	—	13.5 (0.53)	—	3.0 (0.12)	7.6 (0.30)	—	4.3 (0.17)	5.8 (0.23)	—	0.89 (0.035)	1.0 (0.04)	R12, R15, R16

Table R4. Dimensions for Radial-led Devices in Millimeters (Inches) *continued*

Part Number	Dimension													Figures
	A		B		C		D		E		F	H	J	
	Min.	Max.	Min.	Max.	Min.	Max.	Min.	Max.	Min.	Max.	Typ.	Typ.	Typ.	
RUE <i>continued</i>														
30V														
RUE160	—	8.9 (0.35)	—	15.2 (0.60)	—	3.0 (0.12)	7.6 (0.30)	—	4.3 (0.17)	5.8 (0.23)	—	0.89 (0.035)	1.0 (0.04)	R12, R15, R16
RUE185	—	10.2 (0.40)	—	15.7 (0.62)	—	3.0 (0.12)	7.6 (0.30)	—	4.3 (0.17)	5.8 (0.23)	—	0.89 (0.035)	1.0 (0.04)	R12, R15, R16
RUE250	—	11.4 (0.45)	—	18.3 (0.72)	—	3.0 (0.12)	7.6 (0.30)	—	4.3 (0.17)	5.8 (0.23)	—	0.89 (0.035)	1.2 (0.05)	R12, R15, R16
RUE300	—	11.4 (0.45)	—	16.5 (0.65)	—	3.0 (0.12)	7.6 (0.30)	—	4.3 (0.17)	5.8 (0.23)	—	1.19 (0.047)	1.5 (0.06)	R13, R15, R16
RUE400	—	14.0 (0.55)	—	19.3 (0.76)	—	3.0 (0.12)	7.6 (0.30)	—	4.3 (0.17)	5.8 (0.23)	—	1.19 (0.047)	1.7 (0.07)	R13, R15, R16
RUE500	—	14.0 (0.55)	—	24.1 (0.95)	—	3.0 (0.12)	7.6 (0.30)	—	9.4 (0.37)	10.9 (0.43)	—	1.19 (0.047)	1.0 (0.04)	R13, R15, R16
RUE600	—	16.5 (0.65)	—	24.1 (0.95)	—	3.0 (0.12)	7.6 (0.30)	—	9.4 (0.37)	10.9 (0.43)	—	1.19 (0.047)	1.0 (0.04)	R13, R15, R16
RUE700	—	19.1 (0.75)	—	25.9 (1.02)	—	3.0 (0.12)	7.6 (0.30)	—	9.4 (0.37)	10.9 (0.43)	—	1.19 (0.047)	1.2 (0.05)	R13, R15, R16
RUE800	—	21.6 (0.85)	—	28.4 (1.12)	—	3.0 (0.12)	7.6 (0.30)	—	9.4 (0.37)	10.9 (0.43)	—	1.19 (0.047)	1.5 (0.06)	R13, R15, R16
RUE900	—	24.1 (0.95)	—	29.0 (1.14)	—	3.0 (0.12)	7.6 (0.30)	—	9.4 (0.37)	10.9 (0.43)	—	1.19 (0.047)	1.5 (0.06)	R13, R15, R16
RHE														
30V - High Temperature														
RHE050 New	—	7.4 (0.29)	—	12.7 (0.50)	—	3.0 (0.12)	7.6 (0.30)	—	4.3 (0.17)	5.8 (0.23)	1.21 (0.05)	—	—	—
RHE070 New	—	6.86 (0.27)	—	10.8 (0.425)	—	3.0 (0.12)	7.6 (0.30)	—	4.3 (0.17)	5.8 (0.23)	1.2 (0.05)	1.24 (0.049)	1.2 (0.05)	R12, R15, R16
RHE100 New	—	9.7 (0.38)	—	13.6 (0.54)	—	3.0 (0.12)	7.6 (0.30)	—	4.3 (0.17)	5.8 (0.23)	—	—	—	—
RUSB														
16V														
RUSB090	—	7.4 (0.29)	—	12.2 (0.48)	—	3.0 (0.12)	7.6 (0.30)	—	4.3 (0.17)	5.8 (0.23)	—	0.89 (0.035)	0.8 (0.03)	R12, R15, R16
RUSB110	—	7.4 (0.29)	—	14.2 (0.56)	—	3.0 (0.12)	7.6 (0.30)	—	4.3 (0.17)	5.8 (0.23)	—	0.89 (0.035)	0.8 (0.03)	R12, R15, R16
RUSB135	—	8.9 (0.35)	—	13.5 (0.53)	—	3.0 (0.12)	7.6 (0.30)	—	4.3 (0.17)	5.8 (0.23)	—	0.89 (0.035)	1.0 (0.04)	R12, R15, R16
RUSB160	—	8.9 (0.35)	—	15.2 (0.60)	—	3.0 (0.12)	7.6 (0.30)	—	4.3 (0.17)	5.8 (0.23)	—	0.89 (0.035)	1.0 (0.04)	R12, R15, R16
RUSB185	—	10.2 (0.40)	—	15.7 (0.62)	—	3.0 (0.12)	7.6 (0.30)	—	4.3 (0.17)	5.8 (0.23)	—	0.89 (0.035)	1.0 (0.04)	R12, R15, R16
RUSB250	—	11.4 (0.45)	—	18.3 (0.72)	—	3.0 (0.12)	7.6 (0.30)	—	4.3 (0.17)	5.8 (0.23)	—	0.89 (0.035)	1.2 (0.05)	R12, R15, R16
RGE														
16V														
New RGE250	—	8.9 (0.35)	—	12.8 (0.50)	—	3.0 (0.12)	3.18 (0.13)	6.18 (0.24)	4.3 (0.17)	5.8 (0.23)	1.21 (0.05)	1.24 (0.049)	1.2 (0.05)	R12, R15, R16
RGE300	6.1 (0.24)	7.1 (0.28)	6.1 (0.24)	11.0 (0.43)	2.0 (0.08)	3.0 (0.12)	7.6 (0.30)	—	4.3 (0.17)	5.8 (0.23)	1.21 (0.05)	1.24 (0.049)	1.2 (0.05)	R13, R15, R16
RGE400	7.9 (0.31)	8.9 (0.35)	7.9 (0.31)	12.8 (0.50)	2.0 (0.08)	3.0 (0.12)	7.6 (0.30)	—	4.3 (0.17)	5.8 (0.23)	1.21 (0.05)	1.24 (0.049)	1.4 (0.055)	R13, R15, R16
RGE500	9.4 (0.37)	10.4 (0.41)	9.4 (0.37)	14.3 (0.56)	2.0 (0.08)	3.0 (0.12)	7.6 (0.30)	—	4.3 (0.17)	5.8 (0.23)	1.21 (0.05)	1.24 (0.049)	1.6 (0.06)	R13, R15, R16
RGE600	9.7 (0.38)	10.7 (0.42)	12.2 (0.48)	17.1 (0.67)	2.0 (0.08)	3.0 (0.12)	7.6 (0.30)	—	4.3 (0.17)	5.8 (0.23)	1.21 (0.05)	1.24 (0.049)	1.6 (0.06)	R13, R15, R16

Table R4. Dimensions for Radial-led Devices in Millimeters (Inches) *continued*

Part Number	Dimension														Figures
	A		B		C		D		E		F	H	J		
	Min.	Max.	Min.	Max.	Min.	Max.	Min.	Max.	Min.	Max.	Typ.	Typ.	Typ.		
RGE continued															
16V															
RGE700	10.2 (0.40)	11.2 (0.44)	14.7 (0.58)	19.7 (0.78)	2.0 (0.08)	3.0 (0.12)	7.6 (0.30)	—	4.3 (0.17)	5.8 (0.23)	1.21 (0.05)	1.24 (0.049)	1.7 (0.067)	R13, R15, R16	
RGE800	11.7 (0.46)	12.7 (0.50)	16.0 (0.63)	20.9 (0.82)	2.0 (0.08)	3.0 (0.12)	7.6 (0.30)	—	4.3 (0.17)	5.8 (0.23)	1.21 (0.05)	1.24 (0.049)	1.8 (0.07)	R13, R15, R16	
RGE900	13.0 (0.51)	14.0 (0.55)	16.8 (0.66)	21.7 (0.85)	2.0 (0.08)	3.0 (0.12)	7.6 (0.30)	—	4.3 (0.17)	5.8 (0.23)	1.21 (0.05)	1.24 (0.049)	2.0 (0.08)	R13, R15, R16	
RGE1000	15.5 (0.61)	16.5 (0.65)	21.1 (0.83)	25.2 (0.99)	2.0 (0.08)	3.0 (0.12)	7.6 (0.30)	—	4.3 (0.17)	5.8 (0.23)	1.21 (0.05)	1.24 (0.049)	2.0 (0.08)	R13, R15, R16	
RGE1100	16.5 (0.65)	17.5 (0.69)	21.1 (0.83)	26.0 (1.02)	2.0 (0.08)	3.0 (0.12)	7.6 (0.30)	—	4.3 (0.17)	5.8 (0.23)	1.2 (0.05)	1.24 (0.049)	2.4 (0.09)	R13, R15, R16	
RGE1200	16.4 (0.65)	17.5 (0.69)	22.6 (0.89)	28.0 (1.10)	2.3 (0.09)	3.5 (0.14)	7.6 (0.30)	—	9.4 (0.37)	10.9 (0.43)	1.4 (0.06)	1.45 (0.057)	1.5 (0.06)	R13, R15, R16	
RGE1400	22.4 (0.88)	23.5 (0.925)	22.6 (0.89)	27.9 (1.10)	2.3 (0.09)	3.5 (0.14)	7.6 (0.30)	—	9.4 (0.37)	10.9 (0.43)	1.4 (0.06)	1.45 (0.057)	1.9 (0.075)	R13, R15, R16	
RHE															
16V - High Temperature															
New RHE200	—	9.4 (0.37)	14.4 (0.57)	—	—	3.0 (0.12)	7.6 (0.30)	—	4.3 (0.17)	5.8 (0.23)	—	—	—	R10, R15, R16	
RHE400	—	11.4 (0.45)	—	18.0 (0.71)	—	3.0 (0.12)	7.6 (0.30)	—	4.3 (0.17)	5.8 (0.23)	1.2 (0.05)	1.24 (0.049)	1.6 (0.06)	R14, R15, R16	
RHE450	—	10.4 (0.41)	—	15.6 (0.61)	—	3.0 (0.12)	7.6 (0.30)	—	4.3 (0.17)	5.8 (0.23)	1.2 (0.05)	1.24 (0.049)	1.6 (0.06)	R14, R15, R16	
RHE600	—	11.2 (0.44)	—	21.0 (0.83)	—	3.0 (0.12)	7.6 (0.30)	—	4.3 (0.17)	5.8 (0.23)	1.2 (0.05)	1.24 (0.049)	1.7 (0.067)	R14, R15, R16	
RHE650	—	12.7 (0.50)	—	22.2 (0.88)	—	3.0 (0.12)	7.6 (0.30)	—	4.3 (0.17)	5.8 (0.23)	1.2 (0.05)	1.24 (0.049)	1.8 (0.07)	R14, R15, R16	
RHE750	—	14.0 (0.55)	—	23.5 (0.93)	—	3.0 (0.12)	7.6 (0.30)	—	4.3 (0.17)	5.8 (0.23)	1.2 (0.05)	1.24 (0.049)	2.0 (0.08)	R14, R15, R16	
New RHE900	—	16.5 (0.65)	—	25.7 (1.01)	—	3.0 (0.12)	7.6 (0.30)	—	4.3 (0.17)	5.8 (0.23)	—	—	—	—	
RHE1000	—	17.5 (0.69)	—	26.5 (1.04)	—	3.0 (0.12)	7.6 (0.30)	—	9.4 (0.37)	10.9 (0.43)	1.2 (0.05)	1.24 (0.049)	1.5 (0.06)	R14, R15, R16	
RHE1300	—	23.5 (0.925)	—	28.7 (1.13)	—	3.6 (0.14)	7.6 (0.30)	—	9.4 (0.37)	10.9 (0.43)	1.4 (0.06)	1.45 (0.057)	1.9 (0.084)	R14, R15, R16	
RHE1500	—	23.5 (0.925)	—	28.7 (1.13)	—	3.6 (0.14)	7.6 (0.30)	—	9.4 (0.37)	10.9 (0.43)	1.4 (0.06)	1.45 (0.057)	1.9 (0.084)	R14, R15, R16	
RUSB															
6V															
RUSB075	—	6.9 (0.27)	—	11.4 (0.45)	—	3.1 (0.12)	7.6 (0.30)	—	4.3 (0.17)	5.9 (0.23)	—	0.91 (0.036)	1.0 (0.04)	R10, R15, R16	
RUSB120	—	6.9 (0.27)	—	11.7 (0.46)	—	3.1 (0.12)	7.6 (0.30)	—	4.3 (0.17)	5.9 (0.23)	—	0.91 (0.036)	1.0 (0.04)	R10, R15, R16	
RUSB155	—	6.9 (0.27)	—	11.7 (0.46)	—	3.1 (0.12)	7.6 (0.30)	—	4.3 (0.17)	5.9 (0.23)	—	0.91 (0.036)	1.0 (0.04)	R10, R15, R16	

Figures R17–R23. Typical Time-to-trip Curves at 20°C for Radial-leaded Devices

LVR

- A = LVR005
- B = LVR008
- C = LVR012
- D = LVR016
- E = LVR025
- F = LVR033
- G = LVR040
- H = LVR055

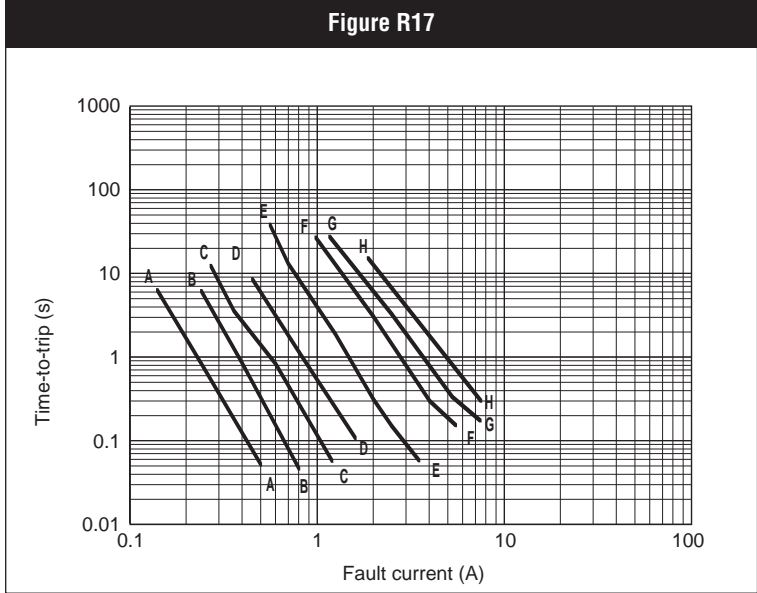

BBR/BBRF

- A = BBR550
- B = BBR750

RTE/RTEF

- C = RTE120
- D = RTE135
- E = RTE190

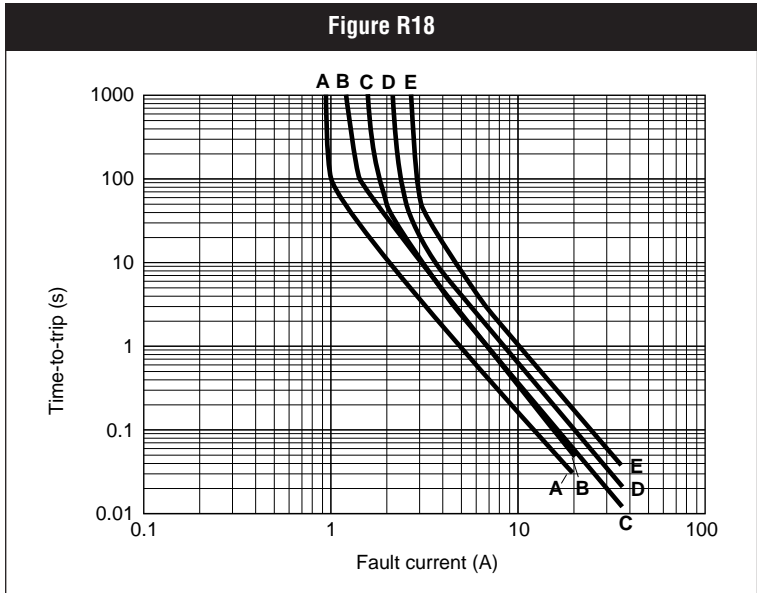

Figures R17–R23. Typical Time-to-trip Curves at 20°C for Radial-led Devices

RXE/RXEF

- | | |
|------------|------------|
| A = RXE005 | J = RXE075 |
| B = RXE010 | K = RXE090 |
| C = RXE017 | L = RXE110 |
| D = RXE020 | M = RXE135 |
| E = RXE025 | N = RXE160 |
| F = RXE030 | O = RXE185 |
| G = RXE040 | P = RXE250 |
| H = RXE050 | Q = RXE300 |
| I = RXE065 | R = RXE375 |

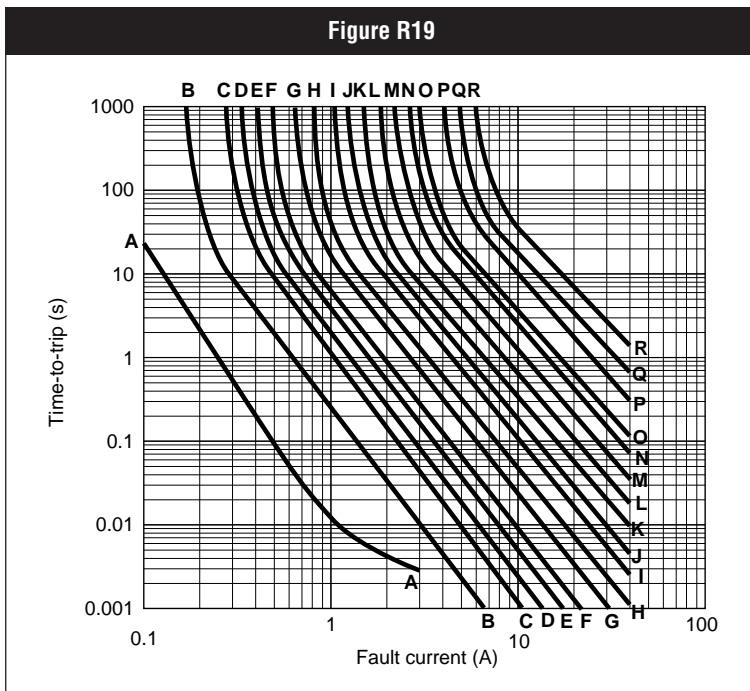

RUE/RUEF

- | | |
|------------|------------|
| A = RUE090 | H = RUE400 |
| B = RUE110 | I = RUE500 |
| C = RUE135 | J = RUE600 |
| D = RUE160 | K = RUE700 |
| E = RUE185 | L = RUE800 |
| F = RUE250 | M = RUE900 |
| G = RUE300 | |

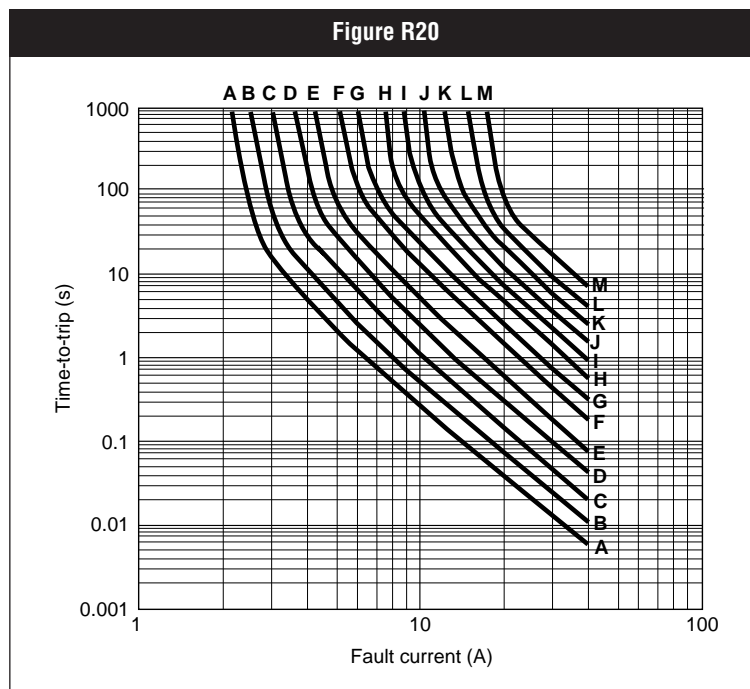

Figures R17–R23. Typical Time-to-trip Curves at 20°C for Radial-leaded Devices *continued*

RGE/RGEF (data at 25°C)

- A = RGE250 H = RGE900
- B = RGE300 I = RGE1000
- C = RGE400 J = RGE1100
- D = RGE500 K = RGE1200
- E = RGE600 L = RGE1400
- F = RGE700
- G = RGE800

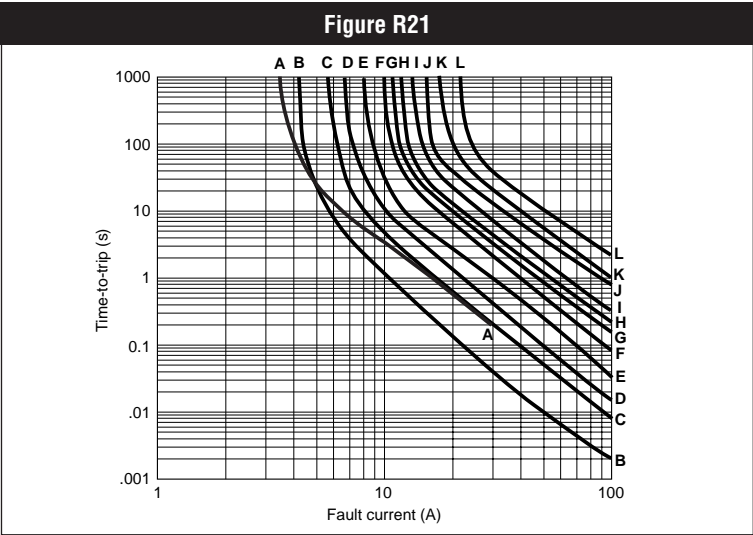

RHE/RHEF (data at 25°C)

- A = RHE050 H = RHE650
- B = RHE070 I = RHE750
- C = RHE100 J = RHE900
- D = RHE200 K = RHE1000
- E = RHE400 L = RHE1300
- F = RHE450 M = RHE1500
- G = RHE600

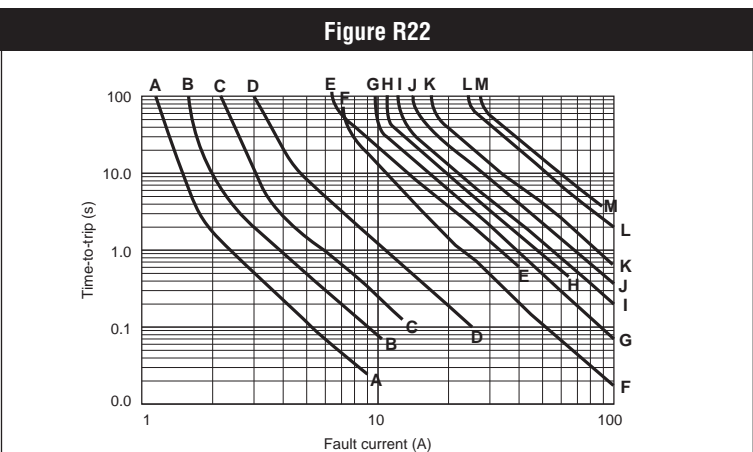

RUSB/RUSBF

- A = RUSB075 F = RUSB155
- B = RUSB090 G = RUSB160
- C = RUSB110 H = RUSB185
- D = RUSB120 I = RUSB250
- E = RUSB135

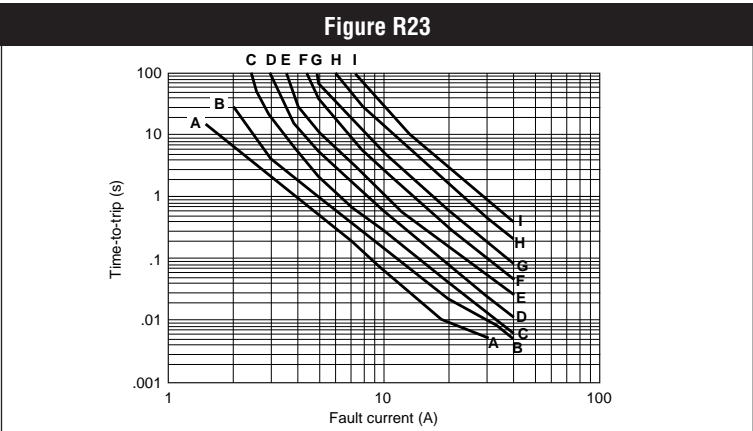

4

Table R5. Physical Characteristics and Environmental Specifications for Radial-leaded Devices

LVR	
Physical Characteristics	
Lead material	LVR005-016: Tin-plated copper, 0.205mm ² (24 AWG), ø 0.51mm (0.020 in.) LVR025-040: Tin-plated copper, 0.32mm ² (22 AWG), ø 0.64mm (0.025 in.) LVR055: Tin-plated copper, 0.52mm ² (20 AWG), ø 0.81mm (0.032 in.)
Soldering characteristics	Solderability per ANSI/J-STD-002 Category 3
Solder heat withstand	per IEC-STD 68-2-20, Test Tb, Method 1a, condition b; can withstand 10 seconds at 260°C ± 5°C

Devices are not designed to be placed through a reflow process.

Environmental Specifications

Test	Conditions	Resistance Change
Passive aging	70°C, 1000 hours	±5%
	85°C, 1000 hours	±5%
Humidity aging	85°C, 85% RH, 1000 hours	±5%
Thermal shock	85°C, -40°C (10 times)	±5%
Solvent resistance	MIL-STD-202, Method 215F	No change

BBR

Physical Characteristics	
Lead material	Tin/lead-plated copper, 0.52mm ² (20 AWG), ø 0.81mm (0.032 in.)
Soldering characteristics	Solderability per ANSI/J-STD-002 Category 3
Solder heat withstand	per IEC-STD 68-2-20, Test Tb, Method 1a, condition b; can withstand 10 seconds at 260°C ± 5°C
Insulating material	Cured, flame-retardant epoxy polymer; meets UL 94V-0

Devices are not designed to be placed through a reflow process.

BBRF

Physical Characteristics	
Lead material	Tin-plated copper
Soldering characteristics	Solderability per ANSI/J-STD-002 Category 3
Solder heat withstand	per IEC-STD 68-2-20, Test Tb, Method 1a, condition b; can withstand 10 seconds at 260°C ± 5°C
Insulating material	Cured, flame-retardant epoxy polymer; meets UL 94V-0

Devices are not designed to be placed through a reflow process.

BBR/BBRF

Environmental Specifications		
Test	Conditions	Resistance Change
Passive aging	70°C, 1000 hours	±5%
	85°C, 1000 hours	±5%
Humidity aging	85°C, 85% RH, 1000 hours	±5%
Thermal shock	85°C, -40°C (10 times)	±5%
Solvent resistance	MIL-STD-202, Method 215F	No change

RXE

Physical Characteristics	
Lead material	RXE005: Tin/lead-plated nickel-copper alloy, 0.128mm ² (26 AWG), ø 0.40mm (0.016 in.)
	RXE010: Tin/lead-plated nickel-copper alloy, 0.205mm ² (24 AWG), ø 0.51mm (0.020 in.)
	RXE017 to 040: Tin/lead-plated copper-clad steel, 0.205mm ² (24 AWG), ø 0.51mm (0.020 in.)
	RXE050 to 090: Tin/lead-plated copper, 0.205mm ² (24 AWG), ø 0.51mm (0.020 in.)
	RXE110 to 375: Tin/lead-plated copper, 0.52mm ² (20 AWG), ø 0.81mm (0.032 in.)
Soldering characteristics	Solderability per ANSI/J-STD-002 Category 3, except RXE005, RXE010 meet ANSI/J-STD-002 Category 1
Solder heat withstand	RXE017 – RXE025: per IEC-STD 68-2-20, Test Tb, Method 1a, condition a; can withstand 5 seconds at 260°C ± 5°C All other sizes: per IEC-STD 68-2-20, Test Tb, Method 1a, condition b; can withstand 10 seconds at 260°C ± 5°C
Insulating material	Cured, flame-retardant epoxy polymer; meets UL 94V-0

Devices are not designed to be placed through a reflow process.

Table R5. Physical Characteristics and Environmental Specifications for Radial-leaded Devices *continued***RXEF****Physical Characteristics**

Lead material	RXEF005: Tin-plated nickel-copper alloy, 0.128mm ² (26 AWG), ø 0.40mm (0.016 in.)
	RXEF010: Tin-plated nickel-copper alloy, 0.205mm ² (24 AWG), ø 0.51mm (0.020 in.)
	RXEF017 to 040: Tin-plated copper-clad steel, 0.205mm ² (24 AWG), ø 0.51mm (0.020 in.)
	RXEF050 to 090: Tin-plated copper, 0.205mm ² (24 AWG), ø 0.51mm (0.020 in.)
	RXEF110 to 375: Tin-plated copper, 0.52mm ² (20 AWG), ø 0.81mm (0.032 in.)
Soldering characteristics	Solderability per ANSI/J-STD-002 Category 3, except RXEF005, RXEF010 meet ANSI/J-STD-002 Category 1
Solder heat withstand	RXEF017 – RXEF025: per IEC-STD 68-2-20, Test Tb, Method 1a, condition a; can withstand 5 seconds at 260°C ± 5°C All other sizes: per IEC-STD 68-2-20, Test Tb, Method 1a, condition b; can withstand 10 seconds at 260°C ± 5°C
Insulating material	Cured, flame-retardant epoxy polymer; meets UL 94V-0

Devices are not designed to be placed through a reflow process.

RXE/RXEF**Environmental Specifications**

Test	Conditions	Resistance Change
Passive aging	-40°C, 1000 hours	±5%
	85°C, 1000 hours	±5%
Humidity aging	85°C, 85% RH, 1000 hours	±10%
Thermal shock	85°C, -40°C (10 times)	±10%
Solvent resistance	MIL-STD-202, Method 215F	No change

RTE**Physical Characteristics**

Lead material	Tin/lead-plated copper-clad steel, 0.205mm ² (24 AWG), ø 0.40mm (0.016 in.)
Soldering characteristics	Solderability per ANSI/J-STD-002 Category 3
Solder heat withstand	per IEC-STD 68-2-20, Test Tb, Method 1a, condition b; can withstand 10 seconds at 260°C ± 5°C
Insulating material	Cured, flame-retardant epoxy polymer; meets UL 94V-0

RTEF**Physical Characteristics**

Lead material	Tin-plated copper-clad steel, 0.205mm ² (24 AWG), ø 0.40mm (0.016 in.)
Soldering characteristics	Solderability per ANSI/J-STD-002 Category 3
Solder heat withstand	per IEC-STD 68-2-20, Test Tb, Method 1a, condition b; can withstand 10 seconds at 260°C ± 5°C
Insulating material	Cured, flame-retardant epoxy polymer; meets UL 94V-0

RTE/RTEF**Environmental Specifications**

Test	Conditions	Resistance Change
Passive aging	70°C, 1000 hours	±5%
	85°C, 1000 hours	±5%
Humidity aging	85°C, 85% RH, 1000 hours	±5%
Thermal shock	85°C, -40°C (10 times)	±5%
Solvent resistance	MIL-STD-202, Method 215F	No change

RUE**Physical Characteristics**

Lead material	RUE090 to RUE250: Tin/lead-plated copper-clad steel, 0.205mm ² (24 AWG) RUE300 to RUE900: Tin/lead-plated copper, 0.52mm ² (20 AWG), ø 0.81mm (0.032 in.)
Soldering characteristics	Solderability per ANSI/J-STD-002 Category 3
Solder heat withstand	per IEC-STD 68-2-20, Test Tb, Method 1a, condition b; can withstand 10 seconds at 260°C ± 5°C
Insulating material	Cured, flame-retardant epoxy polymer; meets UL 94V-0

Devices are not designed to be placed through a reflow process.

Table R5. Physical Characteristics and Environmental Specifications for Radial-leaded Devices *continued***RUEF****Physical Characteristics**

Lead material	RUEF090 to RUEF250: Tin-plated copper-clad steel, 0.205mm ² (24 AWG) RUEF300 to RUEF900: Tin-plated copper, 0.52mm ² (20 AWG), ϕ 0.81mm (0.032 in.)
Soldering characteristics	Solderability per ANSI/J-STD-002 Category 3
Solder heat withstand	per IEC-STD 68-2-20, Test Tb, Method 1a, condition b; can withstand 10 seconds at 260°C \pm 5°C
Insulating material	Cured, flame-retardant epoxy polymer; meets UL 94V-0

Devices are not designed to be placed through a reflow process.

RUE/RUEF**Environmental Specifications**

Test	Conditions	Resistance Change
Passive aging	70°C, 1000 hours	\pm 5%
	85°C, 1000 hours	\pm 5%
Humidity aging	85°C, 85% RH, 1000 hours	\pm 5%
Thermal shock	85°C, -40°C (10 times)	\pm 5%
Solvent resistance	MIL-STD-202, Method 215F	No change

RUSB**Physical Characteristics**

Lead material	RUSBF075: Tin/lead-plated nickel-copper alloy, 0.205mm ² (24 AWG) ϕ 0.51 mm/0.020 in. RUSBF090 to RUSB250: Tin-plated copper clad-steel, 0.205mm ² (24 AWG) ϕ 0.51 mm/0.020 in.
Soldering characteristics	Solderability per ANSI/J-STD-002 Category 3 except RUSBF075 meets ANSI/J-STD-002 Category 1
Solder heat withstand	RUSBF120: per IEC 68-2-20, Test Tb, Method 1a, condition a; can withstand 5 seconds at 260°C \pm 5°C All others: per IEC 68-2-20, Test Tb, Method 1a, condition b; can withstand 10 seconds at 260°C \pm 5°C
Insulating material	Cured, flame-retardant epoxy polymer; meets UL 94V-0

Devices are not designed to be placed through a reflow process.

RUSBF**Physical Characteristics**

Lead material	RUSBF075: Tin-plated nickel-copper alloy, 0.205mm ² (24 AWG) ϕ 0.51 mm/0.020 in. RUSBF090 to RUSBF250: Tin-plated copper clad-steel, 0.205mm ² (24 AWG) ϕ 0.51 mm/0.020 in.
Soldering characteristics	Solderability per ANSI/J-STD-002 Category 3 except RUSBF075 meets ANSI/J-STD-002 Category 1
Solder heat withstand	RUSBF120: per IEC 68-2-20, Test Tb, Method 1a, condition a; can withstand 5 seconds at 260°C \pm 5°C All others: per IEC 68-2-20, Test Tb, Method 1a, condition b; can withstand 10 seconds at 260°C \pm 5°C
Insulating material	Cured, flame-retardant epoxy polymer; meets UL 94V-0

Devices are not designed to be placed through a reflow process.

RUSB/RUSBF**Environmental Specifications**

Test	Conditions	Resistance Change
Passive aging	70°C, 1000 hours	\pm 5%
	85°C, 1000 hours	\pm 5%
Humidity aging	85°C, 85% RH, 1000 hours	\pm 5%
Thermal shock	85°C, -40°C (10 times)	\pm 5%
Solvent resistance	MIL-STD-202, Method 215F	No change

RGE**Physical Characteristics**

Lead material	RGE300 to RGE1100: Tin/lead-plated copper, 0.52mm ² (20 AWG) ϕ 0.81 mm/0.032 in. RGE1200 and RGE1400: Tin/lead-plated copper, 0.82mm ² (18 AWG) ϕ 1.0 mm/0.04 in.
Soldering characteristics	Solderability per ANSI/J-STD 002 Category 3
Solder heat withstand	RGE300K and RGE400: per IEC 68-2-20, Test Tb, Method 1a, condition a; can withstand 5 seconds at 260°C \pm 5°C RGE500 to RGE1400: per IEC 68-2-20 Test Tb, Method 1a, condition b; can withstand 10 seconds at 260°C \pm 5°C
Insulating material	Cured, flame-retardant epoxy polymer; meets UL 94V-0

Devices are not designed to be placed through a reflow process.

Raychem Circuit Protection

Table R5. Physical Characteristics and Environmental Specifications for Radial-leaded Devices *continued***RGEF****Physical Characteristics**

Lead material	RGEF300 to RGEF1100: Tin-plated copper, 0.52mm ² (20 AWG) \varnothing 0.81 mm/0.032 in. RGEF1200 and RGEF1400: Tin-plated copper, 0.82mm ² (18 AWG) \varnothing 1.0 mm/0.04 in.
Soldering characteristics	Solderability per ANSI/J-STD 002 Category 3
Solder heat withstand	RGEF300K and RGEF400: per IEC 68-2-20, Test Tb, Method 1a, condition a; can withstand 5 seconds at 260°C \pm 5°C RGEF500 to RGEF1400: per IEC 68-2-20 Test Tb, Method 1a, condition b; can withstand 10 seconds at 260°C \pm 5°C
Insulating material	Cured, flame-retardant epoxy polymer; meets UL 94V-0

Devices are not designed to be placed through a reflow process.

RGE/RGEF**Environmental Specifications**

Test	Conditions	Resistance Change
Passive aging	-40°C, 1000 hours	\pm 5%
	85°C, 1000 hours	\pm 5%
Humidity aging	85°C, 85% RH, 1000 hours	\pm 5%
Thermal shock	85°C, -40°C (10 times)	\pm 5%
Solvent resistance	MIL-STD-202, Method 215F	No change

RHE**Physical Characteristics**

Lead material	RHEF050 to RHEF400: Tin/lead -plated copper clad steel, 0.205mm ² (24 AWG) \varnothing 0.51 mm/0.020 in. RHEF450 to RHEF1000: Tin/lead-plated copper, 0.52mm ² (20 AWG) \varnothing 0.81 mm/0.032 in. RHEF1300, RHEF1500: Tin/lead-plated copper, 0.82mm ² (18 AWG) \varnothing 1.0 mm/0.04 in.
Soldering characteristics	Solderability per ANSI/J-STD 002 Category 3
Solder heat withstand	Per IEC 68-2-20, Test Tb, Method 1a, condition b; can withstand 10 seconds at 260°C \pm 5°C
Insulating material	Cured, flame-retardant epoxy polymer; meets UL 94V-0

Devices are not designed to be placed through a reflow process.

RHEF**Physical Characteristics**

Lead material	RHEF050 to RHEF400: Tin-plated copper clad steel, 0.205mm ² (24 AWG) \varnothing 0.51 mm/0.020 in. RHEF450 to RHEF1000: Tin-plated copper, 0.52mm ² (20 AWG) \varnothing 0.81 mm/0.032 in. RHEF1300, RHEF1500: Tin-plated copper, 0.82mm ² (18 AWG) \varnothing 1.0 mm/0.04 in.
Soldering characteristics	Solderability per ANSI/J-STD 002 Category 3
Solder heat withstand	Per IEC 68-2-20, Test Tb, Method 1a, condition b; can withstand 10 seconds at 260°C \pm 5°C
Insulating material	Cured, flame-retardant epoxy polymer; meets UL 94V-0

Devices are not designed to be placed through a reflow process.

RHE/RHEF**Environmental Specifications**

Test	Conditions	Resistance Change
Passive aging	70°C, 1000 hours	\pm 5%
	85°C, 1000 hours	\pm 5%
Humidity aging	85°C, 85% RH, 1000 hours	\pm 5%
Thermal shock	125°C, -40°C (10 times)	\pm 5%
Solvent resistance	MIL-STD-202, Method 215F	No change

Devices are not designed to be placed through a reflow process.

Notes:

Storage conditions: 40°C max., 70% RH max.; devices should remain in original sealed bags prior to use. Devices may not meet specified values if these storage conditions are exceeded.

For the TR device series, see the Telecommunications and Networking section.

Agency recognitions for Radial-leaded Devices

UL	File # E74889
CSA	File # CA78165C
TÜV	Certificate number available on request (per IEC 60730-1).

Table R6. Packaging and Marking Information for Radial-led Devices

Part Number	Bag Quantity	Tape and Reel Quantity	Ammo Pack Quantity	Standard Package Quantity	Part Marking	Agency Recognition
LVR 240V_{AC}						
LVR005K	500	—	—	10,000	L005	UL, CSA, TÜV
LVR005K-2	—	500	—	10,000	L005	UL, CSA, TÜV
LVR005S	500	—	—	10,000	L005	UL, CSA, TÜV
LVR005S-2	—	500	—	10,000	L005	UL, CSA, TÜV
LVR008K	500	—	—	10,000	L008	UL, CSA, TÜV
LVR008K-2	—	500	—	10,000	L008	UL, CSA, TÜV
LVR008S	500	—	—	10,000	L008	UL, CSA, TÜV
LVR008S-2	—	500	—	10,000	L008	UL, CSA, TÜV
LVR012K	500	—	—	10,000	L012	UL, CSA, TÜV
LVR012K-2	—	500	—	10,000	L012	UL, CSA, TÜV
LVR012S	500	—	—	10,000	L012	UL, CSA, TÜV
LVR012S-2	—	500	—	10,000	L012	UL, CSA, TÜV
LVR016K	500	—	—	10,000	L016	UL, CSA, TÜV
LVR016K-2	—	500	—	10,000	L016	UL, CSA, TÜV
LVR016S	500	—	—	10,000	L016	UL, CSA, TÜV
LVR016S-2	—	500	—	10,000	L016	UL, CSA, TÜV
LVR025K	500	—	—	10,000	L025	UL, CSA, TÜV
LVR025K-2	—	500	—	10,000	L025	UL, CSA, TÜV
LVR025S	500	—	—	10,000	L025	UL, CSA, TÜV
LVR025S-2	—	500	—	10,000	L025	UL, CSA, TÜV
LVR033S	500	—	—	10,000	L033	UL, CSA, TÜV
LVR033S-2	—	500	—	10,000	L033	UL, CSA, TÜV
LVR033K	500	—	—	10,000	L033	UL, CSA, TÜV
LVR033K-2	—	500	—	10,000	L033	UL, CSA, TÜV
LVR040S	500	—	—	10,000	L040	UL, CSA, TÜV
LVR040S-2	—	500	—	10,000	L040	UL, CSA, TÜV
LVR040K	500	—	—	10,000	L040	UL, CSA, TÜV
LVR040K-2	—	500	—	10,000	L040	UL, CSA, TÜV
LVR055K	500	—	—	10,000	L055	Pending
LVR055S	500	—	—	10,000	L055	Pending
BBR 99V_{AC}						
BBR550	500	—	—	10,000	B550	UL, CSA
BBR550-2	—	1,500	—	7,500	B550	UL, CSA
BBR750	500	—	—	10,000	B750	UL, CSA
BBR750-2	—	1,500	—	7,500	B750	UL, CSA
TR250, TR600 60/600V						
TR250-080U	500	1,500	—	10,000/7,500	08	UL, CSA, TÜV
TR250-120	500	1,500	—	10,000/7,500	20	UL, CSA, TÜV
TR250-145	500	1,500	—	10,000/7,500	45	UL, CSA, TÜV
TR250-180U	500	1,500	—	10,000/7,500	80	UL, CSA, TÜV
TR600-150	500	600	—	10,000/3,000	150	UL, CSA
TR600-160	500	600	—	10,000/3,000	160	UL, CSA
RXE 60V						
RXE005	500	—	—	10,000	—	UL, CSA, TÜV
RXE010	500	—	—	10,000	X010	UL, CSA, TÜV
RXE010-2	—	3,000	—	15,000	X010	UL, CSA, TÜV

Table R6. Packaging and Marking Information for Radial-leaded Devices *continued*

Part Number	Bag Quantity	Tape and Reel Quantity	Ammo Pack Quantity	Standard Package Quantity	Part Marking	Agency Recognition
RXE 60V <i>continued</i>						
RXE010-AP	—	—	2,000	10,000	X010	UL, CSA, TÜV
RXE017	500	—	—	10,000	X017	UL, CSA, TÜV
RXE017-2	—	2,500	—	12,500	X017	UL, CSA, TÜV
RXE017-AP	—	—	2,000	10,000	X017	UL, CSA, TÜV
RXE 72V						
RXE020	500	—	—	10,000	X020	UL, CSA, TÜV
RXE020-2	—	3,000	—	15,000	X020	UL, CSA, TÜV
RXE020-AP	—	—	2,000	10,000	X020	UL, CSA, TÜV
RXE025	500	—	—	10,000	X025	UL, CSA, TÜV
RXE025-2	—	3,000	—	15,000	X025	UL, CSA, TÜV
RXE025-AP	—	—	2,000	10,000	X025	UL, CSA, TÜV
RXE030	500	—	—	10,000	X030	UL, CSA, TÜV
RXE030-2	—	3,000	—	15,000	X030	UL, CSA, TÜV
RXE030-AP	—	—	2,000	10,000	X030	UL, CSA, TÜV
RXE040	500	—	—	10,000	X040	UL, CSA, TÜV
RXE040-2	—	3,000	—	15,000	X040	UL, CSA, TÜV
RXE040-AP	—	—	2,000	10,000	X040	UL, CSA, TÜV
RXE050	500	—	—	10,000	X050	UL, CSA, TÜV
RXE050-2	—	3,000	—	15,000	X050	UL, CSA, TÜV
RXE050-AP	—	—	2,000	10,000	X050	UL, CSA, TÜV
RXE065	500	—	—	10,000	X065	UL, CSA, TÜV
RXE065-2	—	3,000	—	15,000	X065	UL, CSA, TÜV
RXE065-AP	—	—	2,000	10,000	X065	UL, CSA, TÜV
RXE075	500	—	—	10,000	X075	UL, CSA, TÜV
RXE075-2	—	3,000	—	15,000	X075	UL, CSA, TÜV
RXE075-AP	—	—	2,000	10,000	X075	UL, CSA, TÜV
RXE090	500	—	—	10,000	X090	UL, CSA, TÜV
RXE090-2	—	3,000	—	15,000	X090	UL, CSA, TÜV
RXE090-AP	—	—	2,000	10,000	X090	UL, CSA, TÜV
RXE110	500	—	—	10,000	X110	UL, CSA, TÜV
RXE110-2	—	1,500	—	7,500	X110	UL, CSA, TÜV
RXE110-AP	—	—	1,000	5,000	X110	UL, CSA, TÜV
RXE135	500	—	—	10,000	X135	UL, CSA, TÜV
RXE135-2	—	1,500	—	7,500	X135	UL, CSA, TÜV
RXE135-AP	—	—	1,000	5,000	X135	UL, CSA, TÜV
RXE160	500	—	—	10,000	X160	UL, CSA, TÜV
RXE160-2	—	1,500	—	7,500	X160	UL, CSA, TÜV
RXE160-AP	—	—	1,000	5,000	X160	UL, CSA, TÜV
RXE185	500	—	—	10,000	X185	UL, CSA, TÜV
RXE185-2	—	1,500	—	7,500	X185	UL, CSA, TÜV
RXE185-AP	—	—	1,000	5,000	X185	UL, CSA, TÜV
RXE250	250	—	—	5,000	X250	UL, CSA, TÜV
RXE250-2	—	1,000	—	5,000	X250	UL, CSA, TÜV
RXE250-AP	—	—	1,000	5,000	X250	UL, CSA, TÜV
RXE300	250	—	—	5,000	X300	UL, CSA, TÜV
RXE300-2	—	1,000	—	5,000	X300	UL, CSA, TÜV

Table R6. Packaging and Marking Information for Radial-leaded Devices *continued*

Part Number	Bag Quantity	Tape and Reel Quantity	Ammo Pack Quantity	Standard Package Quantity	Part Marking	Agency Recognition
RXE 72V <i>continued</i>						
RXE300-AP	—	—	1,000	5,000	X300	UL, CSA, TÜV
RXE375	250	—	—	5,000	X375	UL, CSA, TÜV
RTE 33V						
RTE120	500	—	—	10,000	T120	UL, CSA, TÜV
RTE120-2	—	3,000	—	15,000	T120	UL, CSA, TÜV
RTE120-AP	—	—	2,000	10,000	T120	UL, CSA, TÜV
RTE135	500	—	—	10,000	T135	UL, CSA, TÜV
RTE135-2	—	3,000	—	15,000	T135	UL, CSA, TÜV
RTE135-AP	—	—	2,000	10,000	T135	UL, CSA, TÜV
RTE190	500	—	—	10,000	T190	UL, CSA, TÜV
RTE190-2	—	3,000	—	15,000	T190	UL, CSA, TÜV
RTE190-AP	—	—	2,000	10,000	T190	UL, CSA, TÜV
RUE 30V						
RUE090	500	—	—	10,000	U090	UL, CSA, TÜV
RUE090-2	—	3,000	—	15,000	U090	UL, CSA, TÜV
RUE090-AP	—	—	2,000	10,000	U090	UL, CSA, TÜV
RUE110	500	—	—	10,000	U110	UL, CSA, TÜV
RUE110-2	—	3,000	—	15,000	U110	UL, CSA, TÜV
RUE110-AP	—	—	2,000	10,000	U110	UL, CSA, TÜV
RUE135	500	—	—	10,000	U135	UL, CSA, TÜV
RUE135-2	—	3,000	—	15,000	U135	UL, CSA, TÜV
RUE135-AP	—	—	2,000	10,000	U135	UL, CSA, TÜV
RUE160	500	—	—	10,000	U160	UL, CSA, TÜV
RUE160-2	—	3,000	—	15,000	U160	UL, CSA, TÜV
RUE160-AP	—	—	2,000	10,000	U160	UL, CSA, TÜV
RUE185	500	—	—	10,000	U185	UL, CSA, TÜV
RUE185-2	—	3,000	—	15,000	U185	UL, CSA, TÜV
RUE185-AP	—	—	2,000	10,000	U185	UL, CSA, TÜV
RUE250	500	—	—	10,000	U250	UL, CSA, TÜV
RUE250-2	—	3,000	—	15,000	U250	UL, CSA, TÜV
RUE250-AP	—	—	2,000	10,000	U250	UL, CSA, TÜV
RUE300	500	—	—	10,000	U300	UL, CSA, TÜV
RUE300-2	—	2,500	—	12,500	U300	UL, CSA, TÜV
RUE300-AP	—	—	1,000	5,000	U300	UL, CSA, TÜV
RUE400	500	—	—	10,000	U400	UL, CSA, TÜV
RUE400-2	—	1,500	—	7,500	U400	UL, CSA, TÜV
RUE400-AP	—	—	1,000	5,000	U400	UL, CSA, TÜV
RUE500	250	—	—	5,000	U500	UL, CSA, TÜV
RUE500-2	—	1,500	—	7,500	U500	UL, CSA, TÜV
RUE500-AP	—	—	1,000	5,000	U500	UL, CSA, TÜV
RUE600	250	—	—	5,000	U600	UL, CSA, TÜV
RUE600-AP	—	—	1,000	5,000	U600	UL, CSA, TÜV
RUE700	250	—	—	5,000	U700	UL, CSA, TÜV
RUE800	250	—	—	5,000	U800	UL, CSA, TÜV
RUE900	250	—	—	5,000	U900	UL, CSA, TÜV

Table R6. Packaging and Marking Information for Radial-leaded Devices *continued*

Part Number	Bag Quantity	Tape and Reel Quantity	Ammo Pack Quantity	Standard Package Quantity	Part Marking	Agency Recognition
RHE 30V - High Temperature						
RHE050	500	—	—	10,000	H0.5	UL, CSA, TÜV
RHE070	500	—	—	10,000	H0.7	UL, CSA, TÜV
RHE070-2	—	—	—	—	—	UL, CSA, TÜV
RHE100	500	—	—	10,000	H1.0	UL, CSA, TÜV
RHE100-2	—	3,000	—	15,000	H1.0	UL, CSA, TÜV
RUSB, RGE 16V						
RUSB090	500	—	—	10,000	R090	UL, CSA, TÜV
RUSB090-2	—	3,000	—	15,000	R090	UL, CSA, TÜV
RUSB090-AP	—	—	2,000	10,000	R090	UL, CSA, TÜV
RUSB110	500	—	—	10,000	R110	UL, CSA, TÜV
RUSB110-2	—	3,000	—	15,000	R110	UL, CSA, TÜV
RUSB110-AP	—	—	2,000	10,000	R110	UL, CSA, TÜV
RUSB135	500	—	—	10,000	R135	UL, CSA, TÜV
RUSB135-2	—	3,000	—	15,000	R135	UL, CSA, TÜV
RUSB135-AP	—	—	2,000	10,000	R135	UL, CSA, TÜV
RUSB155	500	—	—	10,000	R155	UL, CSA, TÜV
RUSB160	500	—	—	10,000	R160	UL, CSA, TÜV
RUSB160-2	—	3,000	—	15,000	R160	UL, CSA, TÜV
RUSB160-AP	—	—	2,000	10,000	R160	UL, CSA, TÜV
RUSB185	500	—	—	10,000	R185	UL, CSA, TÜV
RUSB185-2	—	3,000	—	15,000	R185	UL, CSA, TÜV
RUSB185-AP	—	—	2,000	10,000	R185	UL, CSA, TÜV
RUSB250	500	—	—	10,000	R250	UL, CSA, TÜV
RUSB250-2	—	3,000	—	15,000	R250	UL, CSA, TÜV
RUSB250-AP	—	—	2,000	10,000	R250	UL, CSA, TÜV
RGE 16V						
RGE250	500	—	—	10,000	G250	UL, CSA, TÜV
RGE300	500	—	—	10,000	G300	UL, CSA, TÜV
RGE300-2	—	2,500	—	12,500	G300	UL, CSA, TÜV
RGE300-AP	—	—	2,000	10,000	G300	UL, CSA, TÜV
RGE400	500	—	—	10,000	G400	UL, CSA, TÜV
RGE400-2	—	2,500	—	12,500	G400	UL, CSA, TÜV
RGE400-AP	—	—	2,000	10,000	G400	UL, CSA, TÜV
RGE500	500	—	—	10,000	G500	UL, CSA, TÜV
RGE500-2	—	2,000	—	10,000	G500	UL, CSA, TÜV
RGE500-AP	—	—	2,000	10,000	G500	UL, CSA, TÜV
RGE600	500	—	—	10,000	G600	UL, CSA, TÜV
RGE600-2	—	2,000	—	10,000	G600	UL, CSA, TÜV
RGE600-AP	—	—	2,000	10,000	G600	UL, CSA, TÜV
RGE700	500	—	—	10,000	G700	UL, CSA, TÜV
RGE700-2	—	1,500	—	7,500	G700	UL, CSA, TÜV
RGE700-AP	—	—	1,500	7,500	G700	UL, CSA, TÜV
RGE800	500	—	—	10,000	G800	UL, CSA, TÜV
RGE800-2	—	1,000	—	5,000	G800	UL, CSA, TÜV
RGE800-AP	—	—	1,000	5,000	G800	UL, CSA, TÜV
RGE900	500	—	—	10,000	G900	UL, CSA, TÜV
RGE900-2	—	1,000	—	5,000	G900	UL, CSA, TÜV
RGE900-AP	—	—	1,000	5,000	G900	UL, CSA, TÜV
RGE1000	250	—	—	5,000	G1000	UL, CSA, TÜV



Table R6. Packaging and Marking Information for Radial-led Devices *continued*

Part Number	Bag Quantity	Tape and Reel Quantity	Ammo Pack Quantity	Standard Package Quantity	Part Marking	Agency Recognition
RGE 16V <i>continued</i>						
RGE1000-2	—	1,000	—	5,000	G1000	UL, CSA, TÜV
RGE1000-AP	—	—	1,000	5,000	G1000	UL, CSA, TÜV
RGE1100	250	—	—	5,000	G1100	UL, CSA, TÜV
RGE1100-2	—	1,000	—	5,000	G1100	UL, CSA, TÜV
RGE1100-AP	—	—	1,000	5,000	G1100	UL, CSA, TÜV
RGE1200	250	—	—	5,000	G1200	UL, CSA, TÜV
RGE1200-2	—	1,000	—	5,000	G1200	UL, CSA, TÜV
RGE1200-AP	—	—	1,000	5,000	G1200	UL, CSA, TÜV
RGE1400	250	—	—	5,000	G1400	UL, CSA, TÜV
RGE1400-2	—	1,000	—	5,000	G1400	UL, CSA, TÜV
RGE1400-AP	—	—	1,000	5,000	G1400	UL, CSA, TÜV
RHE 16V - High Temperature						
RHE200	500	—	—	10,000	H2.5	UL, CSA, TÜV
RHE200-2	—	2,500	—	12,500	H2.5	UL, CSA, TÜV
RHE400	500	—	—	10,000	H4	UL, CSA, TÜV
RHE400-2	—	1,500	—	7,500	H4	UL, CSA, TÜV
RHE400-AP	—	—	1,500	7,500	H4.5	UL, CSA, TÜV
RHE450	500	—	—	10,000	H4.5	UL, CSA, TÜV
RHE450-2	—	1,500	—	7,500	H4.5	UL, CSA, TÜV
RHE450-AP	—	—	1,500	7,500	H4.5	UL, CSA, TÜV
RHE600	500	—	—	10,000	H6	UL, CSA, TÜV
RHE600-2	—	1,500	—	7,500	H6	UL, CSA, TÜV
RHE600-AP	—	—	1,500	7,500	H6	UL, CSA, TÜV
RHE650	500	—	—	10,000	H6.5	UL, CSA, TÜV
RHE750	500	—	—	10,000	H7.5	UL, CSA, TÜV
RHE750-2	—	1,000	—	5,000	H7.5	UL, CSA, TÜV
RHE750-AP	—	—	1,000	5,000	H7.5	UL, CSA, TÜV
RHE900	250	—	—	5,000	H9	UL, CSA, TÜV
RHE900-2	—	1,000	—	5,000	H9	UL, CSA, TÜV
RHE900-AP	—	—	1,000	5,000	H9	UL, CSA, TÜV
RHE1000	250	—	—	5,000	H10	UL, CSA, TÜV
RHE1000-2	—	1,000	—	5,000	H10	UL, CSA, TÜV
RHE1000-AP	—	—	1,000	5,000	H10	UL, CSA, TÜV
RHE 16V						
RHE1300	250	—	—	5,000	H13	UL, CSA, TÜV
RHE1300-2	—	1,000	—	5,000	H13	UL, CSA, TÜV
RHE1300-AP	—	—	1,000	5,000	H13	UL, CSA, TÜV
RHE1500	250	—	—	5,000	H15	UL, CSA, TÜV
RHE1500-2	—	1,000	—	5,000	H15	UL, CSA, TÜV
RHE1500-AP	—	—	1,000	5,000	H15	UL, CSA, TÜV
RUSB 6V						
RUSB075	500	—	—	10,000	R075	UL, CSA, TÜV
RUSB075-2	—	3,000	—	15,000	R075	UL, CSA, TÜV
RUSB075-AP	—	—	2,500	12,500	R075	UL, CSA, TÜV
RUSB120	500	—	—	10,000	R120	UL, CSA, TÜV
RUSB120-2	—	3,000	—	15,000	R120	UL, CSA, TÜV
RUSB120-AP	—	—	2,000	10,000	R120	UL, CSA, TÜV
RUSB155	500	—	—	10,000	R155	UL, CSA, TÜV

Part Numbering System

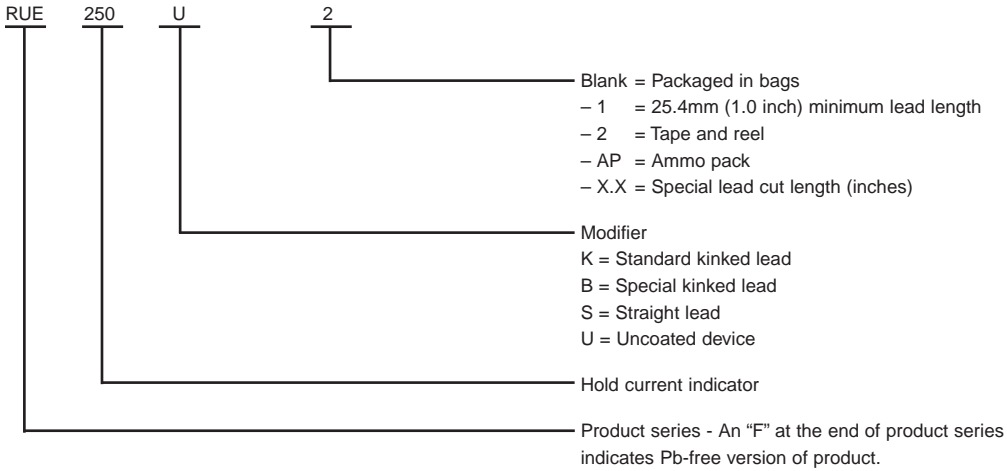

4

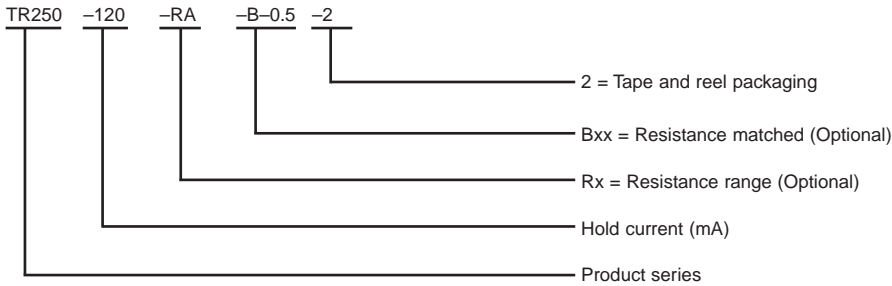

Part Marking System

Side 1

Side 2

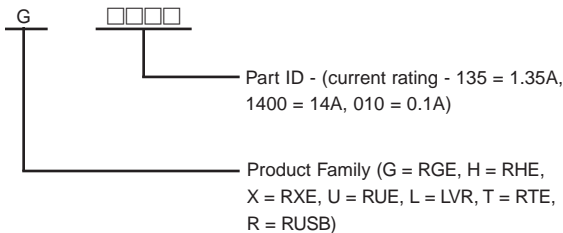
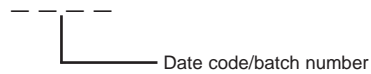
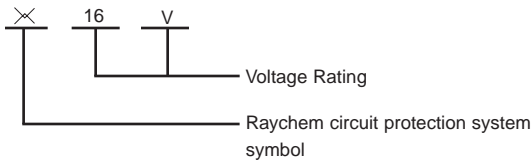

Table R7. Tape and Reel Specifications for Radial-leaded Devices

RXE and BBR devices are available in tape and reel packaging per EIA468–B/IEC60286–2 standards. See Figures R24 and R25 for details.

Description	EIA Mark	Dimension (mm)	Tolerance
Carrier tape width	W	18	-0.5/+1.0
Hold-down tape width	W_2	11	Minimum
Top distance between tape edges	W_6	3	Maximum
Sprocket hole position	W_5	9	-0.5/+0.75
Sprocket hole diameter	D_0	4	± 0.2
Abscissa to plane (straight lead) RXE110 to RXE375	H	18.5	± 2.5
Abscissa to plane (kinked lead) RXE010 to RXE090, BBR550, BBR750	H_0	16.0	± 0.5
Abscissa to top RXE010 to RXE090, BBR550, BBR750	H_1	32.2	Maximum
Abscissa to top* RXE110 to RXE375	H_1	47.5	Maximum
Overall width with lead protrusion RXE010 to RXE090, BBR550, BBR750	C_1	43.2	Maximum
Overall width with lead protrusion* RXE110 to RXE375	C_1	58	Maximum
Overall width without lead protrusion RXE010 to RXE090, BBR550, BBR750	C_2	42.5	Maximum
Overall width without lead protrusion* RXE110 to RXE375	C_2	57	Maximum
Lead protrusion	L_1	1.0	Maximum
Protrusion of cut-out	L	11.0	Maximum
Protrusion beyond hold-down tape	I_2	Not specified	—
Sprocket hole pitch	P_0	12.7	± 0.3
Device pitch RXE010 to RXE090, BBR550, BBR750	—	12.7	± 0.3
Device pitch RXE110 to RXE375	—	25.4	± 0.61
Pitch tolerance	—	20 consecutive	± 1
Tape thickness	t	0.9	Maximum
Overall tape and lead thickness RXE010 to RXE090	t_1	1.5	Maximum
Overall tape and lead thickness RXE110 to RXE375, BBR550, BBR750*	t_1	2.3	Maximum
Splice sprocket hole alignment	—	0	± 0.3
Body lateral deviation	Δh	0	± 1.0
Body tape plane deviation	Δp	0	± 1.3
Ordinate to adjacent component lead RXE010 to RXE090, BBR550, BBR750	P_1	3.81	± 0.7
Ordinate to adjacent component lead RXE110 to RXE375	P_1	7.62	± 0.7
Lead spacing* RXE010 to RXE185, BBR550, BBR750	F	5.08	+0.75/-0.5
Lead spacing* RXE250 to RXE375	F	10.2	+0.75/-0.5
Reel width RXE010 to RXE090	w_2	56.0	Maximum
Reel width* RXE110 to RXE375	w_2	63.5	Maximum
Reel diameter	a	370.0	Maximum
Space between flanges less device	w_1	4.75	± 3.25
Arbor hold diameter	c	26.0	± 12.0
Core diameter*	n	91.0	Maximum
Box	—	64/372/362	Maximum
Consecutive missing places	—	None	—
Empty places per reel	—	0.1%	Maximum

*Differs from EIA specification.

Table R7. Tape and Reel Specifications for Radial-leaded Devices *continued*

RUE, RTE and RUSB devices are available in tape and reel packaging per EIA468-B/IEC60286-2 standards. See Figures R24 and R25 for details.

Description	EIA Mark	Dimension (mm)	Tolerance
Carrier tape width	W	18	-0.5/+1.0
Hold-down tape width	W_A	11	Minimum
Top distance between tape edges	W_B	3	Maximum
Sprocket hole position	W_S	9	-0.5/+0.75
Sprocket hole diameter	D_0	4	± 0.2
Abscissa to plane (straight lead)* RUE300 to RUE900	H	18.5	± 2.5
Abscissa to plane (kinked lead) RUSB075 to RUSB250, RUE090 to RUE250, RTE120 to RTE190	H_0	16.0	± 0.5
Abscissa to top RUSB075 to RUSB250, RUE090 to RUE300, RTE120 to RTE190	H_1	32.2	Maximum
Abscissa to top* RUE400 to RUE900	H_1	45.0	Maximum
Overall width w/lead protrusion RUSB075 to RUSB250, RUE090 to RUE300, RTE120 to RTE190	C_1	43.2	Maximum
Overall width w/ lead protrusion RUE400 to RUE900	C_1	56	Maximum
Overall width w/o lead protrusion RUSB075 to RUSB250, RUE090 to RUE300, RTE120 to RTE190	C_2	42.5	Maximum
Overall width w/o lead protrusion RUE400 to RUE900	C_2	56	Maximum
Lead protrusion	L_1	1.0	Maximum
Protrusion of cut-out	L	11	Maximum
Protrusion beyond hold-down tape	I_2	Not specified	—
Sprocket hole pitch	P_0	12.7	± 0.3
Device pitch RUSB075 to RUSB250, RUE090 to RUE300, RTE120 to RTE190	—	12.7	± 0.3
Device pitch RUE400 to RUE900	—	25.4	± 0.6
Pitch tolerance	—	20 consecutive	± 1
Tape thickness	t	0.9	Maximum
Overall tape and lead thickness RUSB075 to RUSB250, RUE090 to RUE250, RTE120 to RTE190	t_1	1.5	Maximum
Overall tape and lead thickness* RUE300 to RUE900	t_1	2.3	Maximum
Splice sprocket hole alignment	—	0	± 0.3
Body lateral deviation	Δh	0	± 1.0
Body tape plane deviation	Δp	0	± 1.3
Ordinate to adjacent component lead RUSB075 to RUSB250, RUE090 to RUE300, RTE120 to RTE190	P_1	3.81	± 0.7
Ordinate to adjacent component lead RUE400 to RUE900	P_1	7.62	± 0.7
Lead spacing* RUSB075 to RUSB250, RUE090 to RUE400, RTE120 to RTE190	F	5.08	+0.75/-0.5
Lead spacing* RUE500 to RUE900	F	10.2	+0.75/-0.5
Reel width RUE090 to RUE400, RUSB075 to RUSB250, RTE120 to RTE190	w_2	56.0	Maximum
Reel width RUE500* to RUE900	w_2	63.5	Maximum
Reel diameter	a	370.0	Maximum
Space between flanges less device	w_1	4.75	± 3.25
Arbor hold diameter	c	26.0	± 12.0
Core diameter*	n	91.0	Maximum
Box	—	64/372/362	Maximum
Consecutive missing places	—	None	—
Empty places per reel	—	0.1%	Maximum

*Differs from EIA specification.

Table R7. Tape and Reel Specifications for Radial-leaded Devices *continued*

RGE and RHE devices are available in tape and reel packaging per EIA468-B/IEC60286-2 standards. See Figures R24 and R25 for details.

Dimension Description	EIA Mark	Dimension (mm)	Tolerance
Carrier tape width	W	18	-0.5/+1.0
Hold-down tape width	W ₄	11	Minimum
Top distance between tape edges	W ₆	3	Maximum
Sprocket hole position	W ₅	9	-0.5/+0.75
Sprocket hole diameter	D ₀	4	± 0.2
Abscissa to plane (straight lead) RGE250 to RGE1400	H	18.5	± 2.5
Abscissa to plane (kinked lead) RHE050 to RHE1500	H ₀	16.0	± 0.5
Abscissa to top RGE250 to RGE600, RHE050 to RHE450	H ₁	32.2	Maximum
Abscissa to top* RGE700 to RGE1400, RHE600 to RHE1500	H ₁	45.0	Maximum
Overall width w/lead protrusion RGE250 to RGE600, RHE050 to RHE450	C ₁	43.2	Maximum
Overall width w/lead protrusion RGE700 to RGE1400, RHE600 to RHE1500	C ₁	55	Maximum
Overall width w/o lead protrusion RGE250 to RGE600, RHE050 to RHE450	C ₂	42.5	Maximum
Overall width w/o lead protrusion RGE700 to RGE1400, RHE600 to RHE1500	C ₂	54	Maximum
Lead protrusion	L ₁	1.0	Maximum
Protrusion of cut-out	L	11	Maximum
Protrusion beyond hold-down tape	I ₂	Not specified	—
Sprocket hole pitch	P ₀	12.7	± 0.3
Device pitch RGE250 to RGE700, RHE050 to RHE600	—	25.4	± 0.61
Device pitch RGE800 to RGE1400, RHE650 to RHE1500	—	25.4	± 0.6
Pitch tolerance	—	20 consecutive	± 1
Tape thickness	t	0.9	Maximum
Overall tape and lead thickness* RGE250 to RGE1100, RHE050 to RHE1000	t ₁	2.0	Maximum
Overall tape and lead thickness* RGE1200 to RGE1400, RHE1300, RHE1500	t ₁	2.3	Maximum
Splice sprocket hole alignment	—	0	± 0.3
Body lateral deviation	Δh	0	± 1.0
Body tape plane deviation	Δp	0	± 1.3
Ordinate to adjacent component lead RGE300 to RGE1100, RHE400 to RHE750	P ₁	3.81	± 0.7
Ordinate to adjacent component lead RGE1200 to RGE1400, RHE1000 to RHE1500	P ₁	7.62	± 0.7
Lead spacing* RGE250 to RGE1100, RHE050 to RHE900	F	5.08	+0.75 /-0.5
Lead spacing* RGE1200 to RGE1400, RHE1000 to RHE1500	F	10.2	+ 0.75/-0.5
Reel width RGE250 to RGE600, RHE050 to RHE450	w ₂	56.0	Maximum
Reel width* RGE600 to RGE1400 & RHE600 to RHE1500	w ₂	63.5	Maximum
Reel diameter	a	370.0	Maximum
Space between flanges less device*	w ₁	4.75	± 3.25
Arbor hold diameter	c	26.0	± 12.0
Core diameter*	n	91.0	Maximum
Box	—	64/372/362	Maximum
Consecutive missing places	—	None	—
Empty places per reel	—	0.1%	Maximum

*Differs from EIA specification.

Figure R24. EIA Referenced Taped Component Dimensions for Radial-leaded Devices

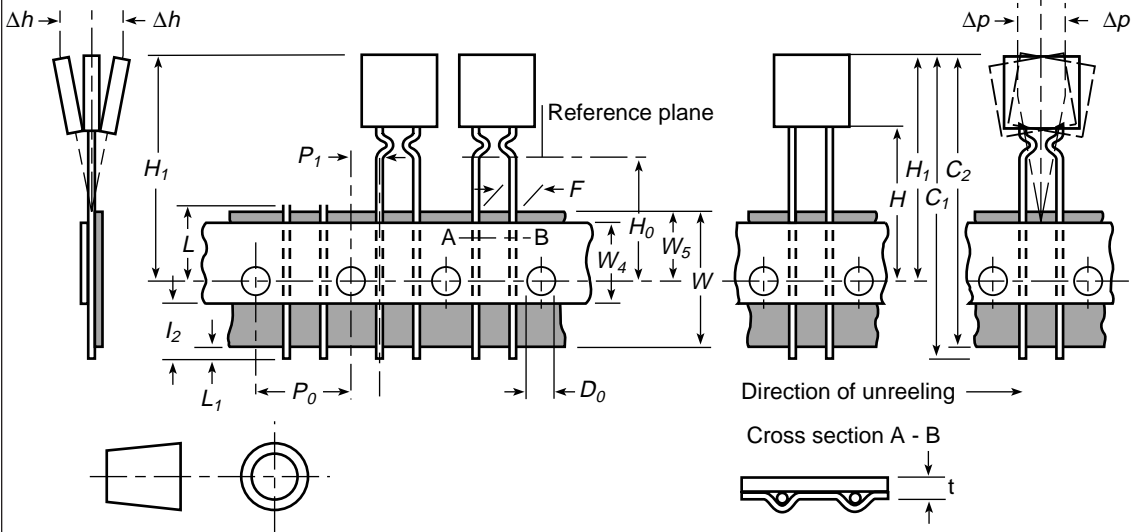
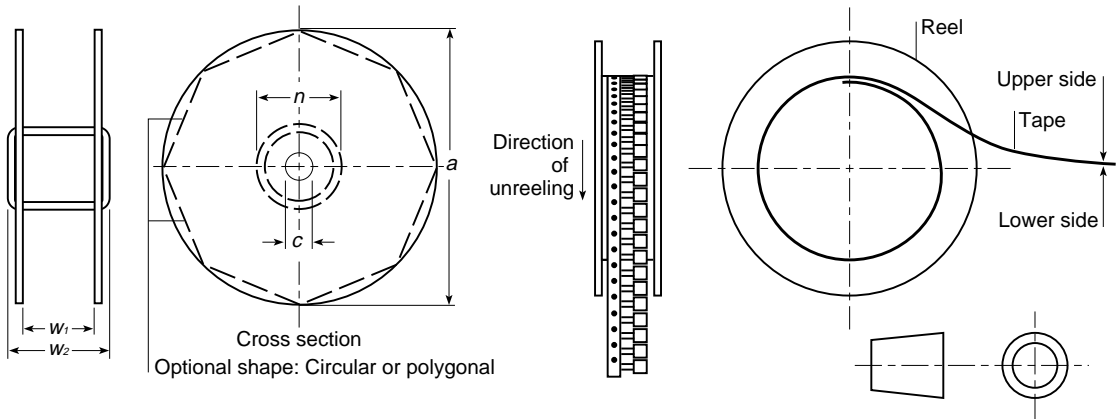

Figure R25. EIA Referenced Reel Dimensions for Radial-leaded Devices



Latest Information

- Please visit us at www.circuitprotection.com or contact your local representative for the latest information.
- The information in this Databook contains some preliminary information. Raychem Circuit Protection, a division of Tyco Electronics, reserves the right to change any of the specifications without notice. In addition, Tyco Electronics reserves the right to make changes—without notification to Buyer—to materials or processing that do not affect compliance with any applicable specification.



WARNING:

- Operation beyond the maximum ratings or improper use may result in device damage and possible electrical arcing and flame.
- The devices are intended for protection against occasional overcurrent or overtemperature fault conditions and should not be used when repeated fault conditions or prolonged trip events are anticipated.
- Contamination of the PPTC material with certain silicon based oils or some aggressive solvents can adversely impact the performance of the devices.
- Device performance can be impacted negatively if devices are handled in a manner inconsistent with recommended electronic, thermal, and mechanical procedures for electronic components.
- Operation in circuits with a large inductance can generate a circuit voltage ($L \frac{di}{dt}$) above the rated voltage of the PolySwitch resettable device.

4