

# DMOS 100mA Low-Dropout Regulator

## FEATURES

- **NEW DMOS TOPOLOGY:**  
Ultra Low Dropout Voltage:  
60mV typ at 100mA  
Output capacitor NOT required for stability
- **FAST TRANSIENT RESPONSE**
- **VERY LOW NOISE:** 23 $\mu$ Vrms
- **HIGH ACCURACY:**  $\pm$ 1.5% max
- **HIGH EFFICIENCY:**  
 $I_{GND} = 500\mu$ A at  $I_{OUT} = 100$ mA  
Not Enabled:  $I_{GND} = 10$ nA
- **2.5V, 2.8V, 2.85V, 3.0V, 3.3V, 5.0V, AND ADJUSTABLE OUTPUT VERSIONS**
- **OTHER OUTPUT VOLTAGES AVAILABLE UPON REQUEST**
- **FOLDBACK CURRENT LIMIT**
- **THERMAL PROTECTION**
- **SMALL SURFACE-MOUNT PACKAGES:**  
SOT23-5 and SO-8

## APPLICATIONS

- PORTABLE COMMUNICATION DEVICES
- BATTERY-POWERED EQUIPMENT
- PERSONAL DIGITAL ASSISTANTS
- MODEMS
- BAR-CODE SCANNERS
- BACKUP POWER SUPPLIES

## DESCRIPTION

The REG101 is a family of low-noise, low-dropout linear regulators with low ground pin current. Its new DMOS topology provides significant improvement over previous designs, including low dropout voltage (only 60mV typ at full load), and better transient performance. In addition, no output capacitor is required for stability, unlike conventional low-dropout regulators that are difficult to compensate and require expensive low ESR capacitors greater than 1 $\mu$ F.

Typical ground pin current is only 500 $\mu$ A (at  $I_{OUT} = 100$ mA) and drops to 10nA when not in enabled mode. Unlike regulators with PNP pass devices, quiescent current remains relatively constant over load variation and under dropout conditions.

The REG101 has very low output noise (typically 23 $\mu$ Vrms for  $V_{OUT} = 3.3$ V with  $C_{NR} = 0.01\mu$ F), making it ideal for use in portable communications equipment. Accuracy is maintained over temperature, line, and load variations. Key parameters are tested over the specified temperature range ( $-40^{\circ}$ C to  $+85^{\circ}$ C).

The REG101 is well protected—internal circuitry provides a current limit that protects the load from damage. Thermal protection circuitry keeps the chip from being damaged by excessive temperature. The REG101 is available in the SOT23-5 and the SO-8 packages.

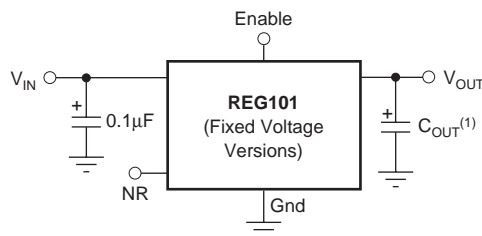

NR = Noise Reduction

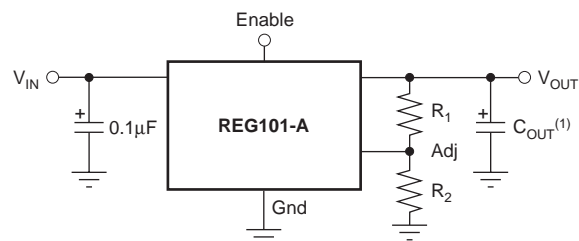

NOTE: (1) Optional.



Please be aware that an important notice concerning availability, standard warranty, and use in critical applications of Texas Instruments semiconductor products and disclaimers thereto appears at the end of this data sheet.

All trademarks are the property of their respective owners.

## ABSOLUTE MAXIMUM RATINGS<sup>(1)</sup>

Supply Input Voltage, $V_{IN}$ .....	-0.3V to 12V
Enable Input Voltage, $V_{EN}$ .....	-0.3V to $V_{IN}$
Feedback Voltage, $V_{FB}$ .....	-0.3V to 6.0V
NR Pin Voltage, $V_{NR}$ .....	-0.3V to 6.0V
Output Short-Circuit Duration .....	Indefinite
Operating Temperature Range ( $T_J$ ) .....	-55°C to +125°C
Storage Temperature Range ( $T_A$ ) .....	-65°C to +150°C
Lead Temperature (soldering, 3s, SOT23-5, and SO-8) .....	+240°C

NOTE: (1) Stresses above these ratings may cause permanent damage. Exposure to absolute maximum conditions for extended periods may degrade device reliability.



## ELECTROSTATIC DISCHARGE SENSITIVITY

This integrated circuit can be damaged by ESD. Texas Instruments recommends that all integrated circuits be handled with appropriate precautions. Failure to observe proper handling and installation procedures can cause damage.

ESD damage can range from subtle performance degradation to complete device failure. Precision integrated circuits may be more susceptible to damage because very small parametric changes could cause the device not to meet its published specifications.

## PACKAGE/ORDERING INFORMATION<sup>(1)</sup>

PRODUCT	$V_{OUT}$ <sup>(2)</sup>
REG101xx-yyy/zzz	<p><b>XX</b> is package designator.</p> <p><b>YYYY</b> is typical output voltage (5 = 5.0V, 2.85 = 2.85V, A = Adjustable).</p> <p><b>ZZZ</b> is package quantity.</p>

(1) For the most current package and ordering information, see the Package Option Addendum at the end of this document, or see the TI website at [www.ti.com](http://www.ti.com).

(2) Output voltages from 2.5V to 5.1V in 50mV increments are available; minimum order quantities apply. Contact factory for details and availability.

## PIN CONFIGURATIONS

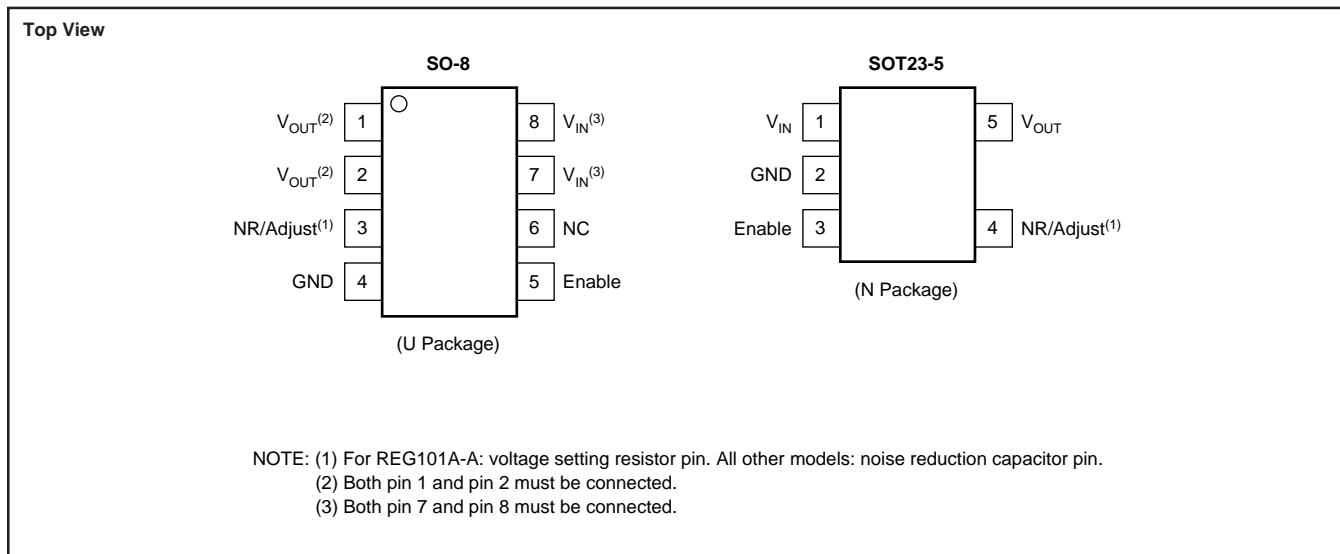

# ELECTRICAL CHARACTERISTICS

**Boldface limits apply over the specified temperature range,  $T_J = -40^{\circ}\text{C}$  to  $+85^{\circ}\text{C}$ .**

At  $T_J = +25^{\circ}\text{C}$ ,  $V_{IN} = V_{OUT} + 1\text{V}$  ( $V_{OUT} = 2.5\text{V}$  for REG101-A),  $V_{ENABLE} = 1.8\text{V}$ ,  $I_{OUT} = 2\text{mA}$ ,  $C_{NR} = 0.01\mu\text{F}$ , and  $C_{OUT} = 0.1\mu\text{F}^{(1)}$ , unless otherwise noted.

PARAMETER	CONDITION	REG101NA REG101UA			UNITS
		MIN	TYP	MAX	
<b>OUTPUT VOLTAGE</b>					
Output Voltage	$V_{OUT}$				
REG101-2.5			2.5		V
REG101-2.8			2.8		V
REG101-2.85			2.85		V
REG101-3.0			3.0		V
REG101-3.3			3.3		V
REG101-5			5		V
REG101-A		2.5		5.5	V
Reference Voltage	$V_{REF}$		1.267		V
Adjust Pin Current	$I_{ADJ}$		0.2	1	$\mu\text{A}$
Accuracy			$\pm 0.5$	$\pm 1.5$	%
<b>Over Temperature vs Temperature</b>	$dV_{OUT}/dT$		<b>50</b>	<b><math>\pm 2.2</math></b>	%
Includes Line and Load		$I_{OUT} = 2\text{mA}$ to $100\text{mA}$ , $V_{IN} = (V_{OUT} + 0.4\text{V})$ to $10\text{V}$	$\pm 0.8$	$\pm 2.0$	%
<b>Over Temperature</b>		$V_{IN} = (V_{OUT} + 0.6\text{V})$ to $10\text{V}$		<b><math>\pm 2.7</math></b>	%
<b>DC DROPOUT VOLTAGE<sup>(2)</sup></b>	$V_{DROP}$				
For all models		$I_{OUT} = 2\text{mA}$	4	10	mV
		$I_{OUT} = 100\text{mA}$	60	100	mV
<b>Over Temperature</b>		$I_{OUT} = 100\text{mA}$		<b>130</b>	mV
<b>VOLTAGE NOISE</b>	$V_n$				
Without $C_{NR}$		$f = 10\text{Hz}$ to $100\text{kHz}$			
With $C_{NR}$ (all fixed voltage models)		$C_{NR} = 0$ , $C_{OUT} = 0$			
		$C_{NR} = 0.01\mu\text{F}$ , $C_{OUT} = 10\mu\text{F}$			
			$23\mu\text{Vrms/V} \cdot V_{OUT}$		$\mu\text{Vrms}$
			$7\mu\text{Vrms/V} \cdot V_{OUT}$		$\mu\text{Vrms}$
<b>OUTPUT CURRENT</b>					
Current Limit <sup>(3)</sup>	$I_{CL}$		130	170	220
<b>Over Temperature</b>			<b>110</b>		<b>240</b>
Short-Circuit Current	$I_{SC}$			60	
<b>RIPPLE REJECTION</b>					
$f = 120\text{Hz}$		$I_{OUT} = 100\text{mA}$		65	
<b>ENABLE CONTROL</b>					
$V_{ENABLE}$ High (output enabled)	$V_{ENABLE}$		1.8		$V_{IN}$
$V_{ENABLE}$ Low (output disabled)			-0.2		0.5
$I_{ENABLE}$ High (output enabled)	$I_{ENABLE}$	$V_{ENABLE} = 1.8\text{V}$ to $V_{IN}$ , $V_{IN} = 1.8\text{V}$ to $6.5^{(4)}$		1	100
$I_{ENABLE}$ Low (output disabled)		$V_{ENABLE} = 0\text{V}$ to $0.5\text{V}$		2	100
Output Disable Time		$C_{OUT} = 1.0\mu\text{F}$ , $R_{LOAD} = 33\Omega$		200	$\mu\text{s}$
Output Enable Time		$C_{OUT} = 1.0\mu\text{F}$ , $R_{LOAD} = 33\Omega$		1.5	ms
<b>THERMAL SHUTDOWN</b>					
Junction Temperature Shutdown				160	$^{\circ}\text{C}$
Reset from Shutdown				140	$^{\circ}\text{C}$
<b>GROUND PIN CURRENT</b>					
Ground Pin Current	$I_{GND}$	$I_{OUT} = 2\text{mA}$		400	$\mu\text{A}$
		$I_{OUT} = 100\text{mA}$		500	$\mu\text{A}$
Enable Pin Low		$V_{ENABLE} \leq 0.5\text{V}$		0.01	0.2
<b>INPUT VOLTAGE</b>	$V_{IN}$				
Operating Input Voltage Range <sup>(5)</sup>			1.8		10
Specified Input Voltage Range		$V_{IN} > 1.8\text{V}$	$V_{OUT} + 0.4$		10
<b>Over Temperature</b>		$V_{IN} > 1.8\text{V}$	<b><math>V_{OUT} + 0.6</math></b>		<b>10</b>
<b>TEMPERATURE RANGE</b>					
Specified Range	$T_J$		-40		+85
Operating Range	$T_J$		-55		+125
Storage Range	$T_A$		-65		+150
Thermal Resistance					
SOT23-5 Surface Mount	$\theta_{JA}$	Junction-to-Ambient		200	$^{\circ}\text{C/W}$
SO-8 Surface Mount	$\theta_{JA}$	Junction-to-Ambient		150	$^{\circ}\text{C/W}$

- NOTES: (1) The REG101 does not require a minimum output capacitor for stability. However, transient response can be improved with proper capacitor selection.  
(2) Dropout voltage is defined as the input voltage minus the output voltage that produces a 2% change in the output voltage from the value at  $V_{IN} = V_{OUT} + 1\text{V}$  at fixed load.  
(3) Current limit is the output current that produces a 10% change in output voltage from  $V_{IN} = V_{OUT} + 1\text{V}$  and  $I_{OUT} = 2\text{mA}$ .  
(4) For  $V_{ENABLE} > 6.5\text{V}$ , see typical characteristic " $I_{ENABLE}$  vs  $V_{ENABLE}$ ".  
(5) The REG101 no longer regulates when  $V_{IN} < V_{OUT} + V_{DROP(MAX)}$ . In drop-out, the impedance from  $V_{IN}$  to  $V_{OUT}$  is typically less than  $1\Omega$  at  $T_J = +25^{\circ}\text{C}$ .

# TYPICAL CHARACTERISTICS

For all models, at  $T_J = +25^\circ\text{C}$  and  $V_{\text{ENABLE}} = 1.8\text{V}$ , unless otherwise noted.

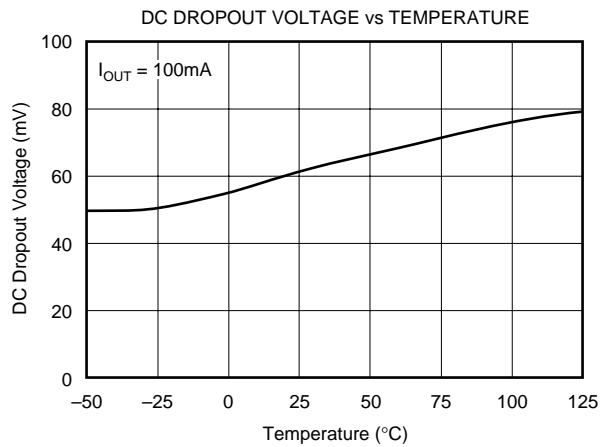
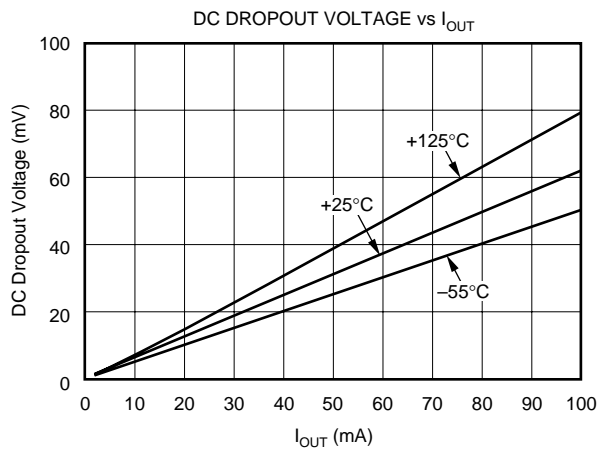
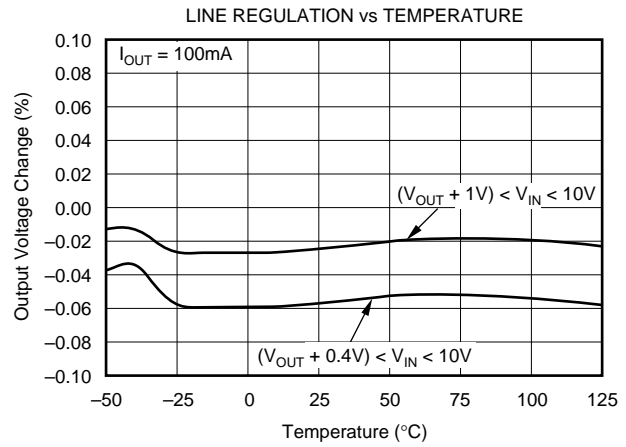
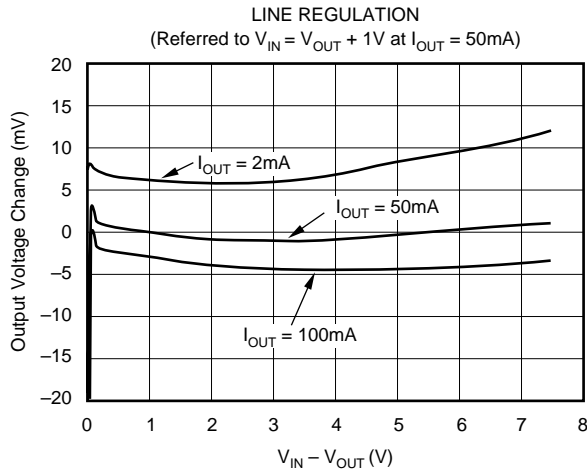
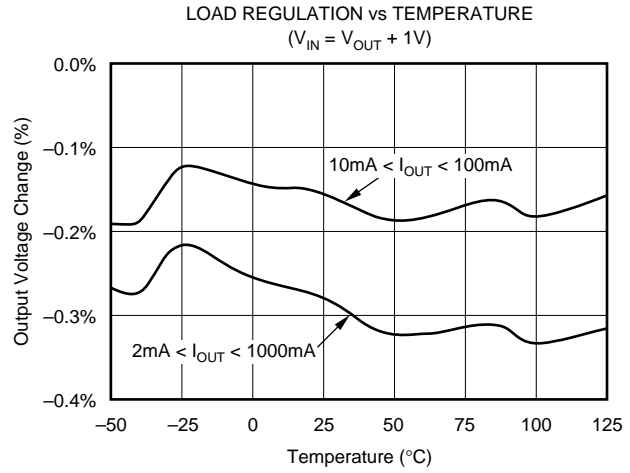
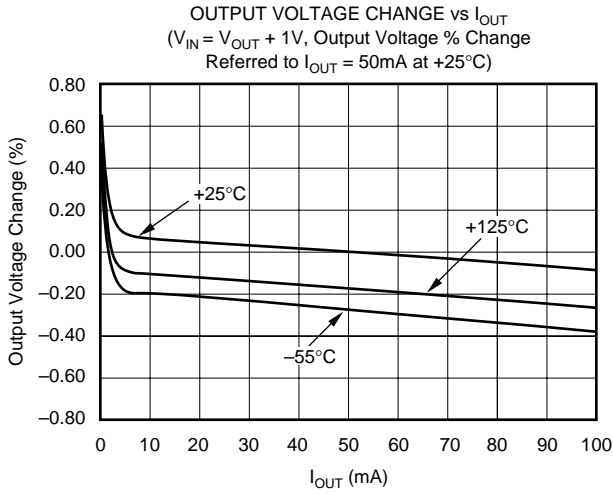

# TYPICAL CHARACTERISTICS (Cont.)

For all models, at  $T_J = +25^\circ\text{C}$  and  $V_{\text{ENABLE}} = 1.8\text{V}$ , unless otherwise noted.

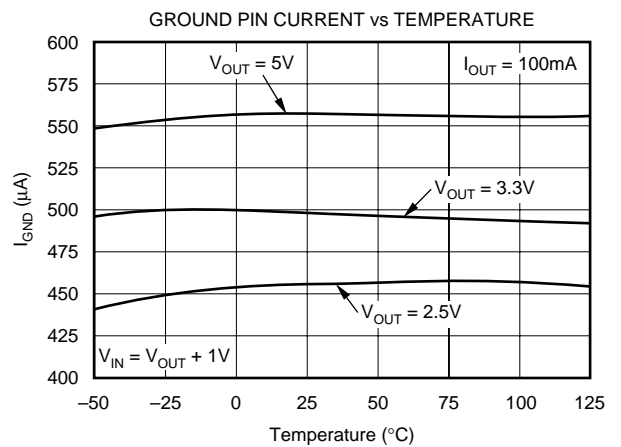
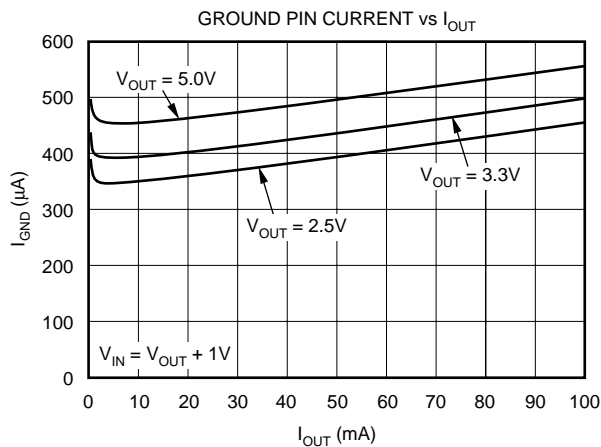
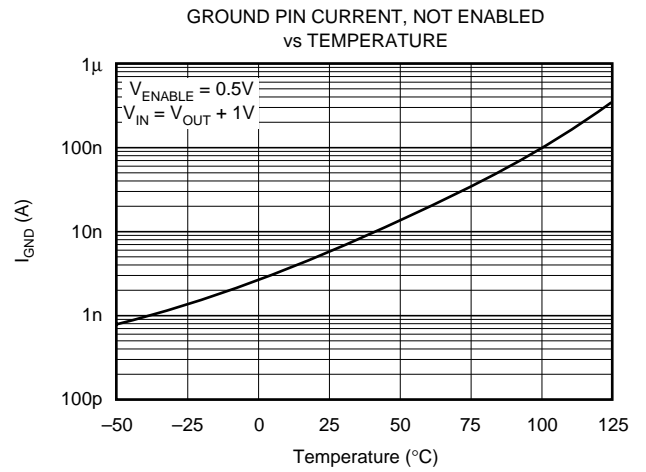
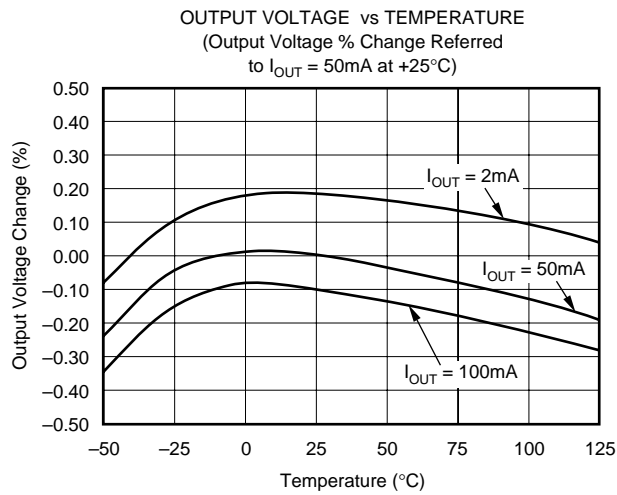
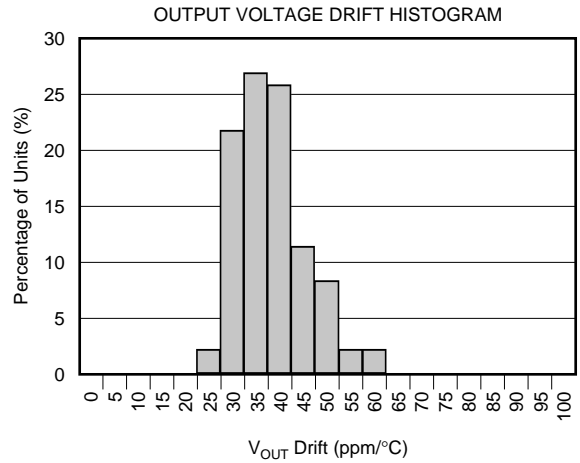
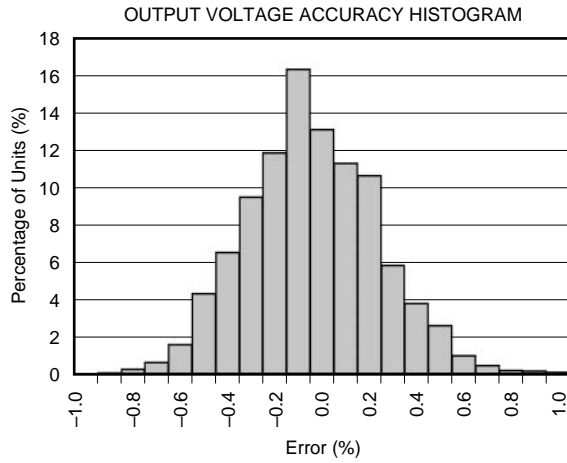

# TTYPICAL CHARACTERISTICS (Cont.)

For all models, at  $T_J = +25^\circ\text{C}$  and  $V_{\text{ENABLE}} = 1.8\text{V}$ , unless otherwise noted.

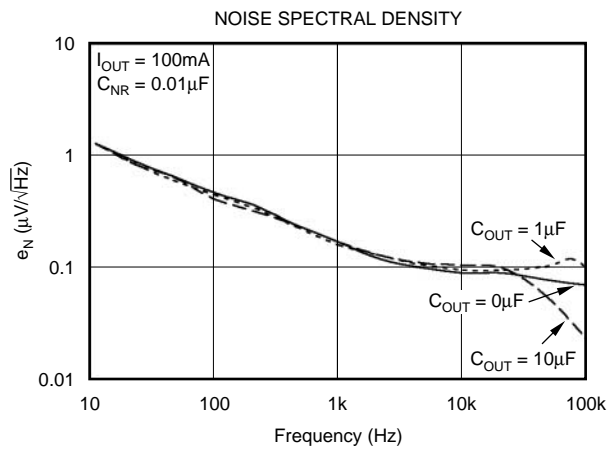
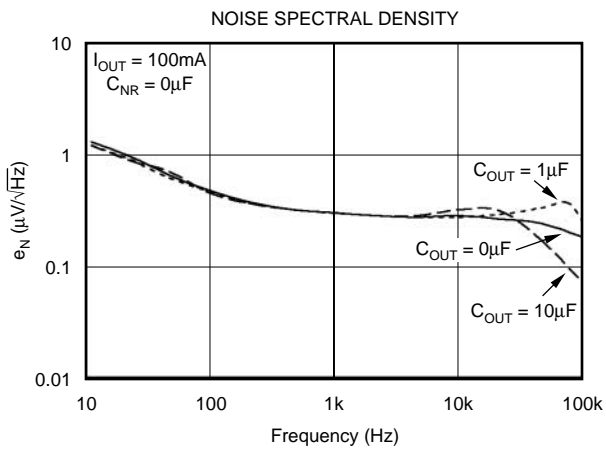
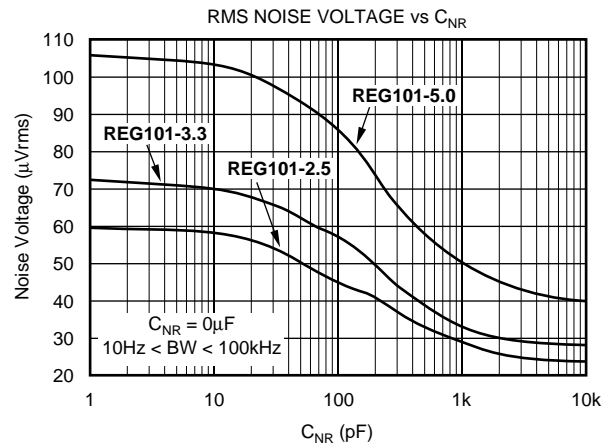
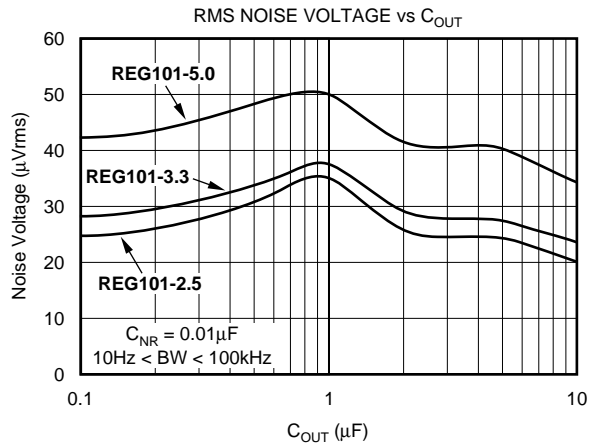
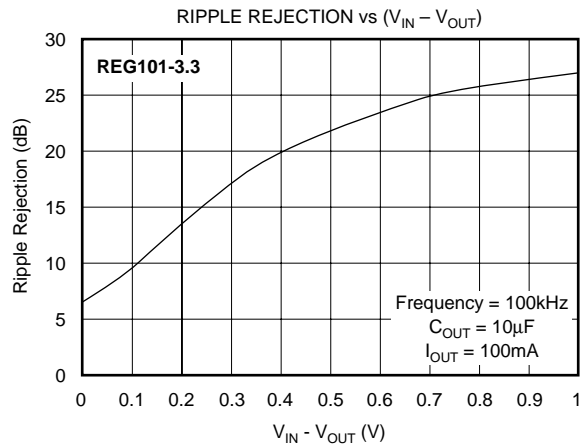
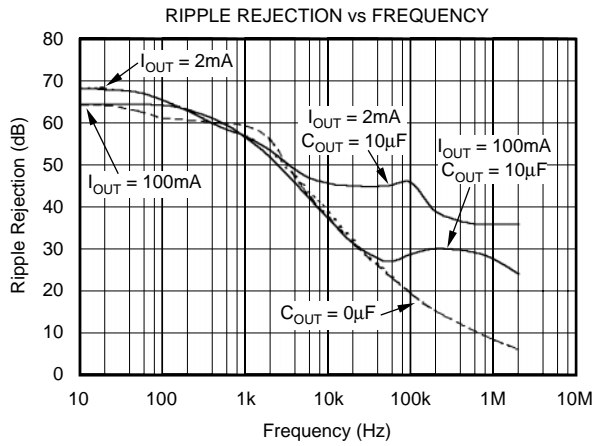

# TYPICAL CHARACTERISTICS (Cont.)

For all models, at  $T_J = +25^\circ\text{C}$  and  $V_{\text{ENABLE}} = 1.8\text{V}$ , unless otherwise noted.

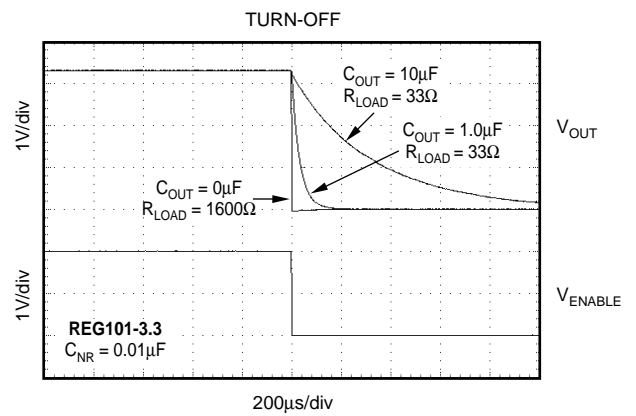
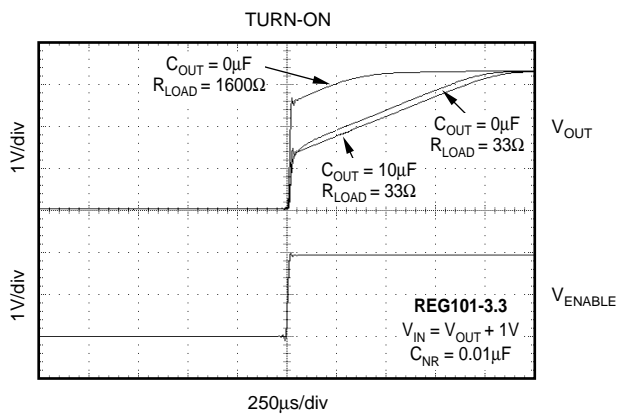
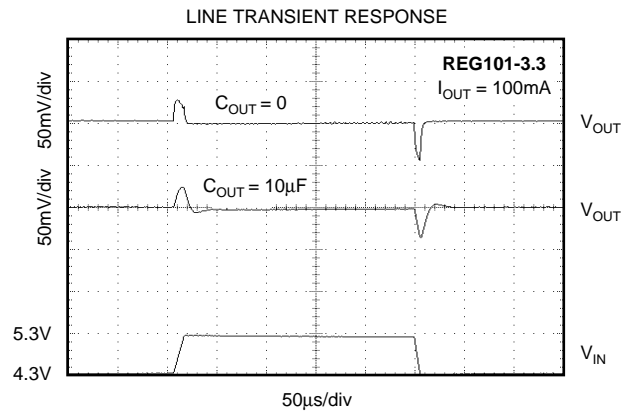
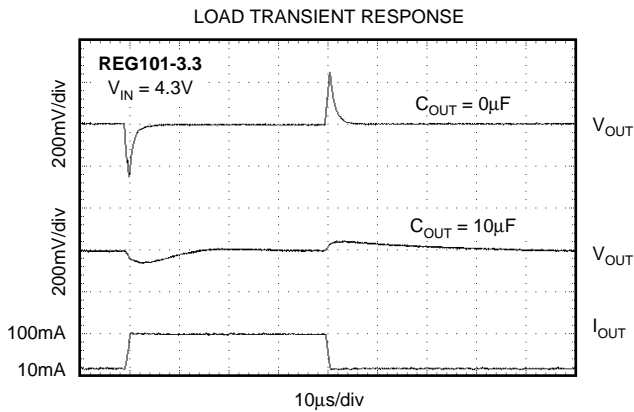
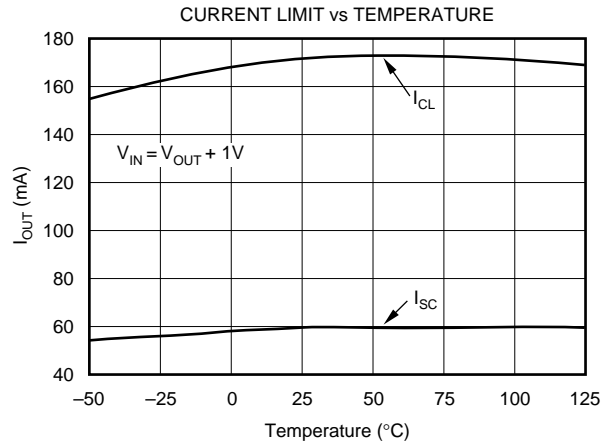
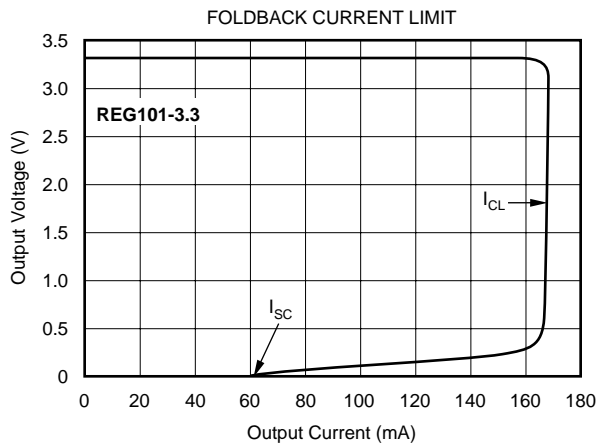

# TYPICAL CHARACTERISTICS (Cont.)

For all models, at  $T_J = +25^\circ\text{C}$  and  $V_{\text{ENABLE}} = 1.8\text{V}$ , unless otherwise noted.

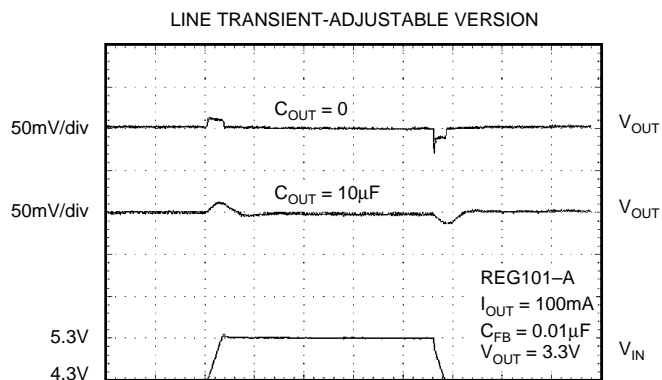
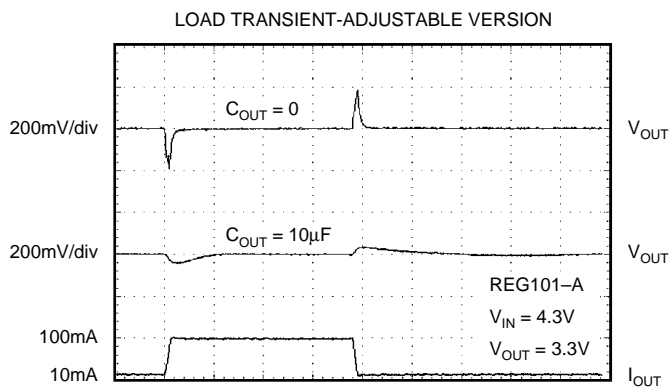
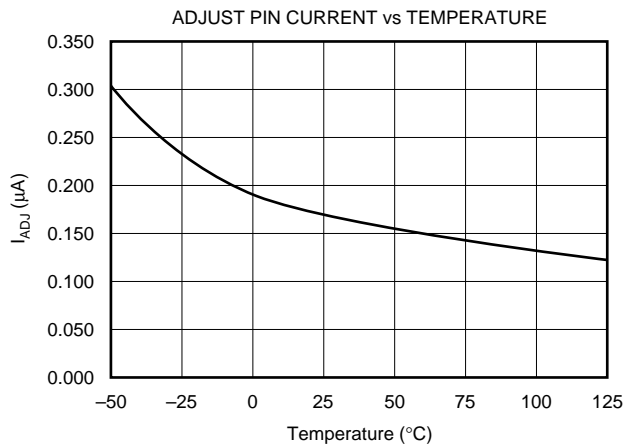
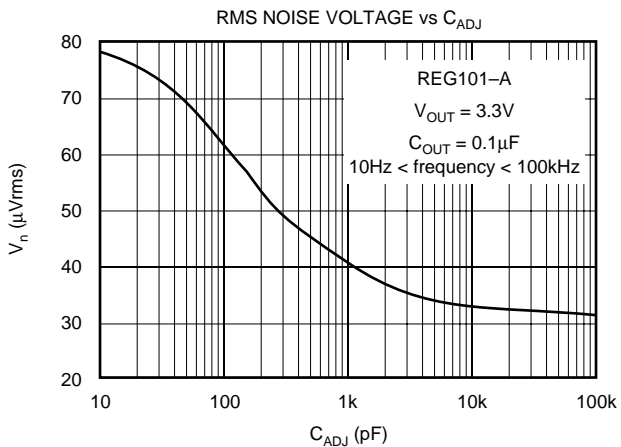
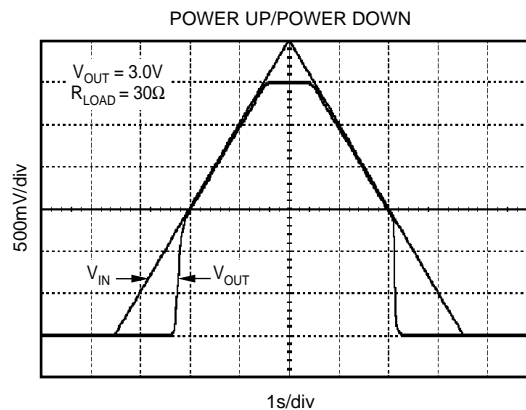
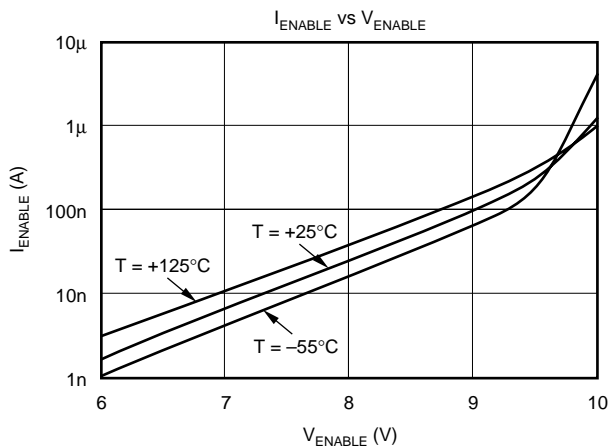

# BASIC OPERATION

The REG101 series of LDO (Low Drop-Out) linear regulators offers a wide selection of fixed output voltage versions and an adjustable output version. The REG101 belongs to a family of new generation LDO regulators that utilize a DMOS pass transistor to achieve ultra-low dropout performance and freedom from output capacitor constraints. Ground pin current remains under 650µA over all line, load, and temperature conditions. All versions have thermal and over-current protection, including foldback current limit.

The REG101 does not require an output capacitor for regulator stability and is stable over most output currents and with almost any value and type of output capacitor up to 10µF or more. For applications where the regulator output current drops below several milliamps, stability can be enhanced by: adding a 1kΩ to 2kΩ load resistor; using capacitance values less than 10µF; or keeping the effective series resistance greater than 0.05Ω including the capacitor's ESR and parasitic resistance in printed circuit board traces, solder joints, and sockets.

Although an input capacitor is not required, it is good analog design practice to connect a 0.1µF low ESR capacitor across

the input supply voltage. This is recommended to improve ripple rejection by reducing input voltage ripple.

Figure 1 shows the basic circuit connections for the fixed voltage models. Figure 2 gives the connections for the adjustable output version (REG101A) and example resistor values for some commonly used output voltages. Values for other voltages can be calculated from the equation shown in Figure 2.

## INTERNAL CURRENT LIMIT

The REG101 internal current limit has a typical value of 170mA. A foldback feature limits the short-circuit current to a typical short-circuit value of 60mA. This helps to protect the regulator from damage under all load conditions. A characteristic of  $V_{OUT}$  versus  $I_{OUT}$  is given in Figure 3 and in the Typical Characteristics section.

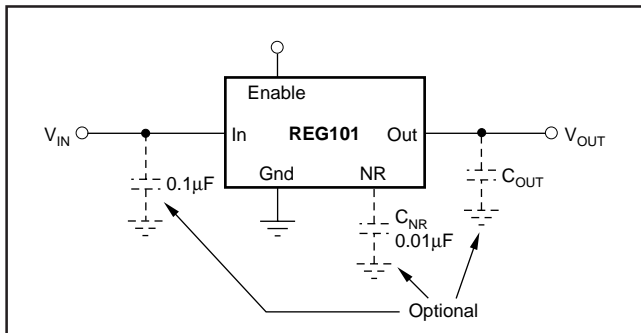

FIGURE 1. Fixed Voltage Nominal Circuit for REG101.

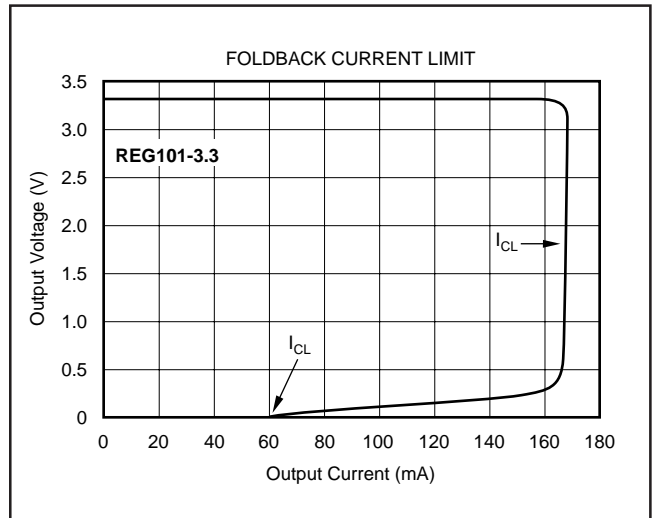

FIGURE 3. Foldback Current Limit of the REG101-3.3 at 25°C.

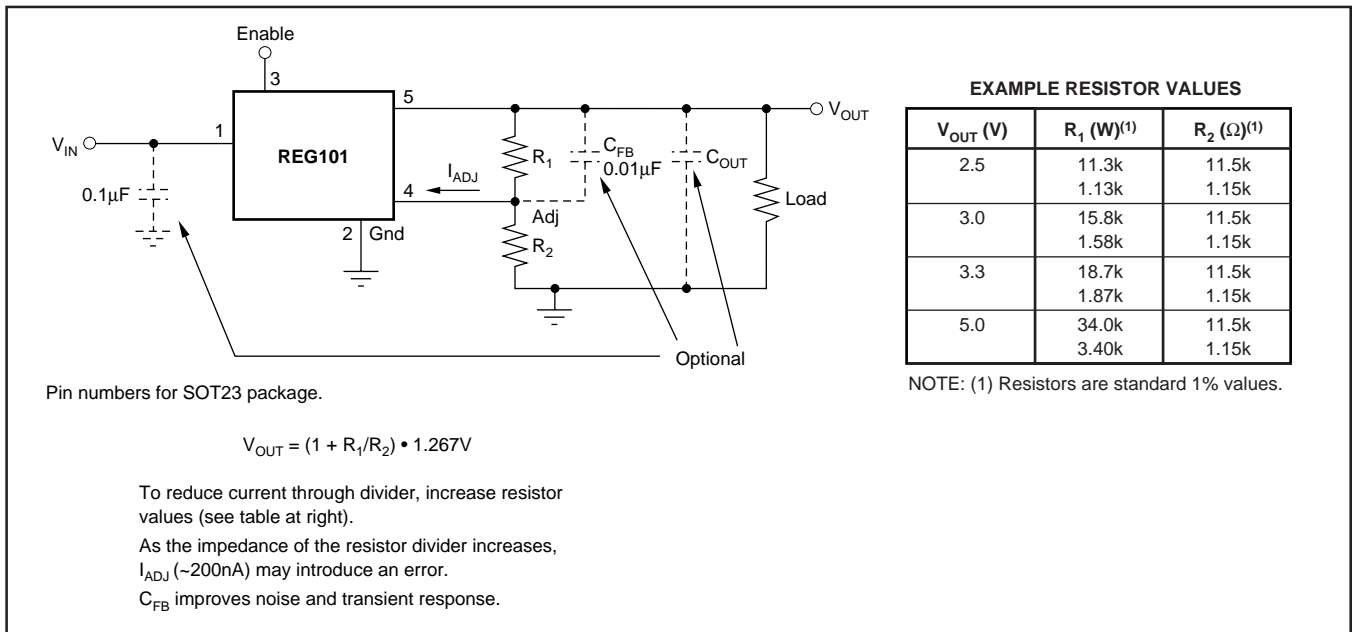

FIGURE 2. Adjustable Voltage Circuit for REG101A.

## ENABLE

The Enable pin is active HIGH and compatible with standard TTL-CMOS levels. Inputs below 0.5V (max) turn the regulator off and all circuitry is disabled. Under this condition, ground pin current drops to approximately 10nA. When a pull-up resistor is used, and operation down to  $V_{IN} = 1.8V$  is required, use values  $< 50k\Omega$ .

## OUTPUT NOISE

A precision band-gap reference is used for the internal reference voltage,  $V_{REF}$ . This reference is the dominant noise source within the REG101 and it generates approximately  $29\mu V_{rms}$  in the 10Hz to 100kHz bandwidth at the reference output. The regulator control loop gains up the reference noise, so that the noise voltage of the regulator is approximately given by:

$$V_N = 29\mu V_{rms} \frac{R_1 + R_2}{R_2} = 29\mu V_{rms} \cdot \frac{V_{OUT}}{V_{REF}}$$

Since the value of  $V_{REF}$  is 1.267V, this relationship reduces to:

$$V_N = 23 \frac{\mu V_{rms}}{V} \cdot V_{OUT}$$

Connecting a capacitor,  $C_{NR}$ , from the Noise Reduction (NR) pin to ground, as shown in Figure 4, forms a low-pass filter for the voltage reference. For  $C_{NR} = 10nF$ , the total noise in the 10Hz to 100kHz bandwidth is reduced by approximately a factor of 2.8 for  $V_O = 3.3V$ . This noise reduction effect is shown in Figure 5 and as “RMS Noise Voltage vs CNR” in the Typical Characteristics section.

Noise can be further reduced by carefully choosing an output capacitor,  $C_{OUT}$ . Best overall noise performance is

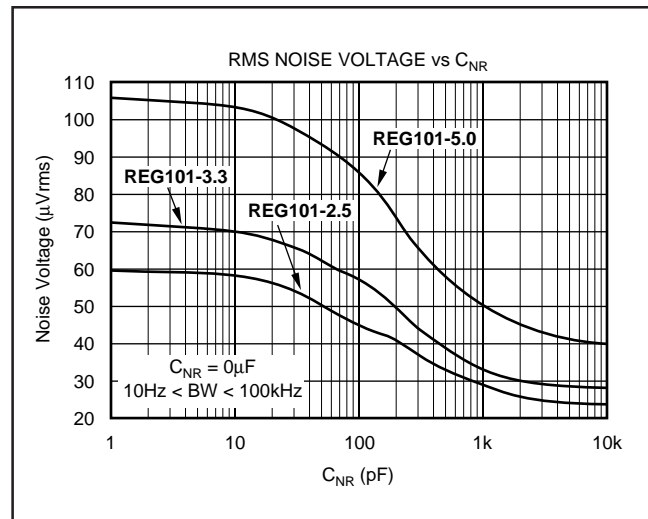

FIGURE 5. Output Noise versus Noise Reduction Capacitor.

achieved with very low ( $< 0.22\mu F$ ) or very high ( $> 2.2\mu F$ ) values of  $C_{OUT}$ . See “RMS Noise Voltage vs  $C_{OUT}$ ” in the Typical Characteristics section.

The REG101 utilizes an internal charge pump to develop an internal supply voltage sufficient to drive the gate of the DMOS pass element above  $V_{IN}$ . The charge-pump switching noise (nominal switching frequency = 2MHz) is not measurable at the output of the regulator over most values of  $C_{OUT}$  and  $I_{OUT}$ .

The REG101 adjustable version does not have the noise-reduction pin available, however, the adjust pin is the summing junction of the error amplifier. A capacitor,  $C_{FB}$ , connected from the output to the adjust pin will reduce both the output noise and the peak error from a load transient. See the typical characteristics for output noise performance.

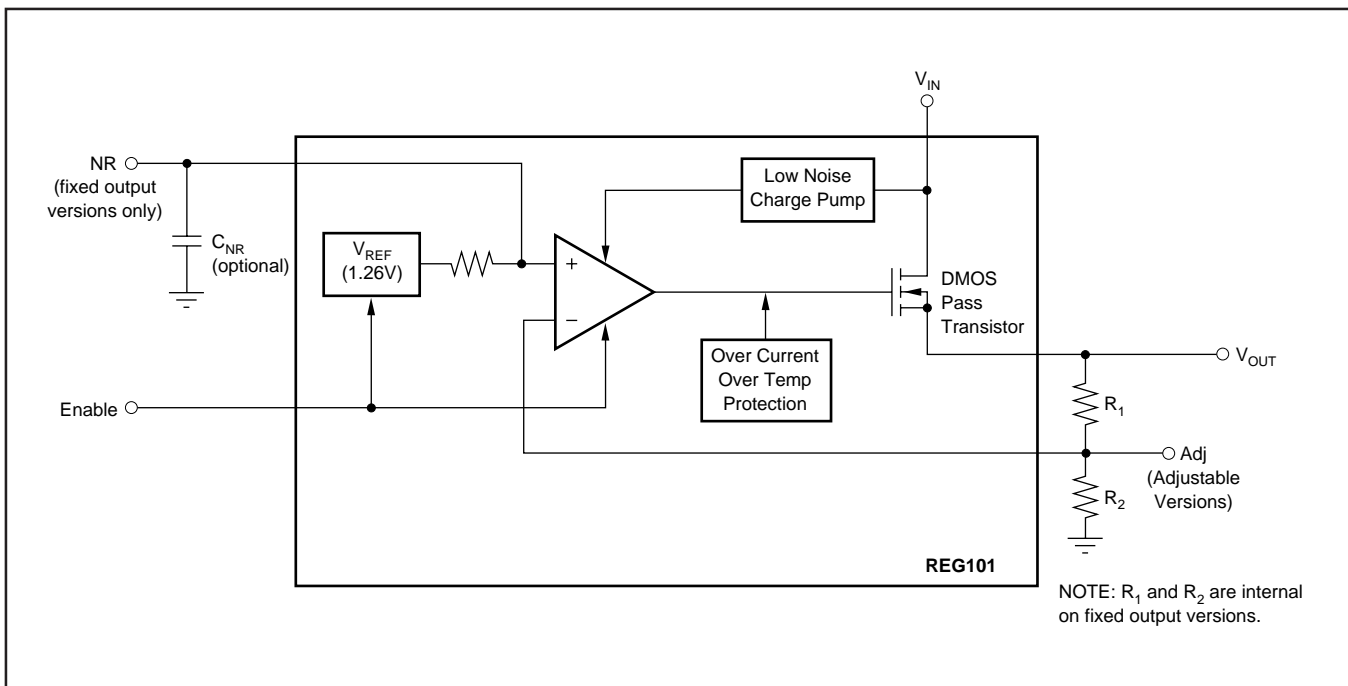

FIGURE 4. Block Diagram.

## DROP-OUT VOLTAGE

The REG101 uses an N-channel DMOS as the “pass” element. When the input voltage is within a few tens of millivolts of the output voltage, the DMOS device behaves like a resistor. Therefore, for low values of  $V_{IN}$  to  $V_{OUT}$ , the regulator’s input-to-output resistance is the  $R_{ds(ON)}$  of the DMOS pass element (typically 600m $\Omega$ ). For static (DC) loads, the REG101 will typically maintain regulation down to  $V_{IN}$  to  $V_{OUT}$  voltage drop of 60mV at full rated output current. In Figure 6, the bottom line (DC dropout) shows the minimum  $V_{IN}$  to  $V_{OUT}$  voltage drop required to prevent drop-out under DC load conditions.

For large step changes in load current, the REG101 requires a larger voltage drop across it to avoid degraded transient response. The boundary of this “transient drop-out” region is shown as the top line in Figure 6. Values of  $V_{IN}$  to  $V_{OUT}$  voltage drop above this line insure normal transient response.

In the transient dropout region between “DC” and “Transient”, transient response recovery time increases. The time required to recover from a load transient is a function of both the magnitude and rate of the step change in load current and the available “headroom”  $V_{IN}$  to  $V_{OUT}$  voltage drop. Under worst-case conditions (full-scale load change with  $V_{IN}$  to  $V_{OUT}$  voltage drop close to DC dropout levels), the REG101 can take several hundred microseconds to re-enter the specified window of regulation.

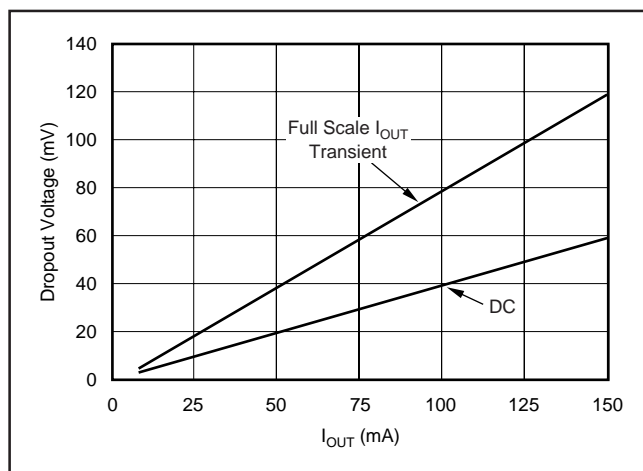

FIGURE 6. Transient and DC Dropout.

## TRANSIENT RESPONSE

The REG101 response to transient line and load conditions improves at lower output voltages. The addition of a capacitor (nominal value 0.47 $\mu$ F) from the output pin to ground may improve the transient response. In the adjustable version, the addition of a capacitor,  $C_{FB}$  (nominal value 10nF), from the output to the adjust pin will also improve the transient response.

## THERMAL PROTECTION

The REG101 has thermal shutdown circuitry that protects the regulator from damage. The thermal protection circuitry disables the output when the junction temperature reaches approximately 160°C, allowing the device to cool. When the junction temperature cools to approximately 140°C, the output circuitry is again enabled. Depending on various conditions, the thermal protection circuit may cycle on and off. This limits the dissipation of the regulator, but may have an undesirable effect on the load.

Any tendency to activate the thermal protection circuit indicates excessive power dissipation or an inadequate heat sink. For reliable operation, junction temperature should be limited to 125°C, maximum. To estimate the margin of safety in a complete design (including heat sink), increase the ambient temperature until the thermal protection is triggered. Use worst-case loads and signal conditions. For good reliability, thermal protection should trigger more than 35°C above the maximum expected ambient condition of your application. This produces a worst-case junction temperature of 125°C at the highest expected ambient temperature and worst-case load.

The internal protection circuitry of the REG101 has been designed to protect against overload conditions. It was not intended to replace proper heat sinking. Continuously running the REG101 into thermal shutdown will degrade reliability.

## POWER DISSIPATION

The REG101 is available in two different package configurations. The ability to remove heat from the die is different for each package type and, therefore, presents different considerations in the printed circuit board (PCB) layout. The PCB area around the device that is free of other components moves the heat from the device to the ambient air. While it is difficult to impossible to quantify all of the variables in a thermal design of this type, performance data for several configurations are shown in Figure 7.

Power dissipation depends on input voltage, load condition, and duty cycle. Power dissipation is equal to the product of the average output current times the voltage across the output element,  $V_{IN}$  to  $V_{OUT}$  voltage drop.

$$P_D = (V_{IN} - V_{OUT}) \cdot I_{OUT(AVG)}$$

Power dissipation can be minimized by using the lowest possible input voltage necessary to assure the required output voltage.

## REGULATOR MOUNTING

Solder pad footprint recommendations for the various REG101 devices are presented in the Application Bulletin AB-132, "Solder Pad Recommendations for Surface-Mount Devices" (SBFA015), available from the Texas Instruments web site ([www.ti.com](http://www.ti.com)).

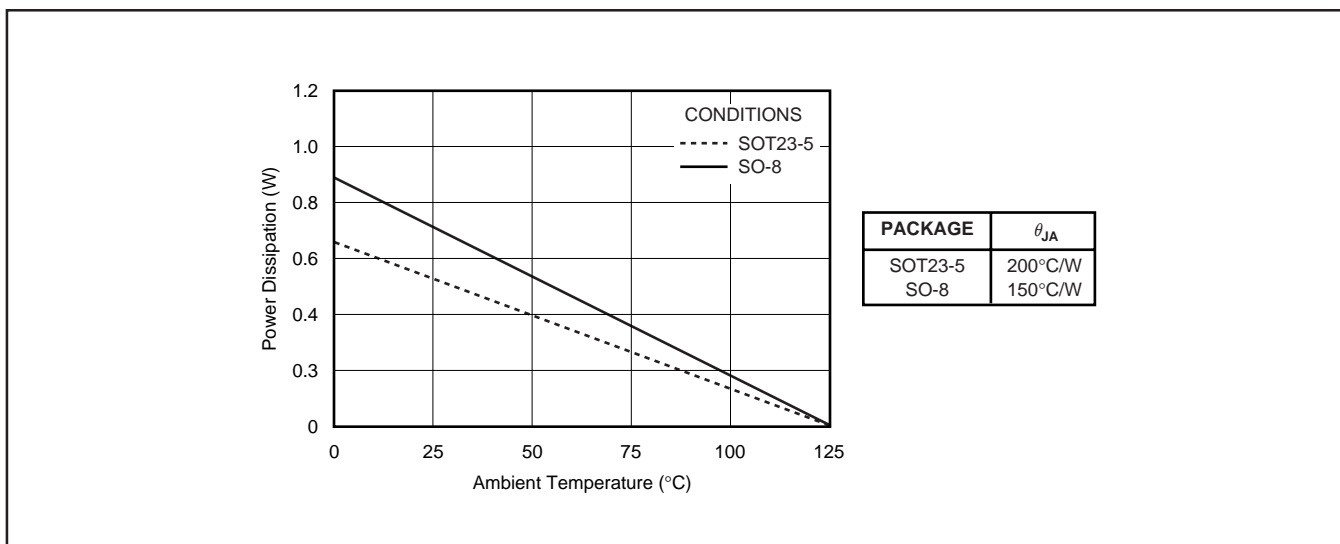

FIGURE 7. Maximum Power Dissipation versus Ambient Temperature for the Various Packages.

**PACKAGING INFORMATION**

Orderable Device	Status (1)	Package Type	Package Drawing	Pins	Package Qty	Eco Plan (2)	Lead/Ball Finish (6)	MSL Peak Temp (3)	Op Temp (°C)	Device Marking (4/5)	Samples
REG101NA-2.5/250	ACTIVE	SOT-23	DBV	5	250	Green (RoHS & no Sb/Br)	CU NIPDAU	Level-1-260C-UNLIM		RO1G	<a href="#">Samples</a>
REG101NA-2.5/250G4	ACTIVE	SOT-23	DBV	5	250	Green (RoHS & no Sb/Br)	CU NIPDAU	Level-1-260C-UNLIM		RO1G	<a href="#">Samples</a>
REG101NA-2.5/3K	ACTIVE	SOT-23	DBV	5	3000	Green (RoHS & no Sb/Br)	CU NIPDAU	Level-1-260C-UNLIM		RO1G	<a href="#">Samples</a>
REG101NA-2.8/250	ACTIVE	SOT-23	DBV	5	250	Green (RoHS & no Sb/Br)	CU NIPDAU	Level-1-260C-UNLIM		RO1E	<a href="#">Samples</a>
REG101NA-2.85/250	ACTIVE	SOT-23	DBV	5	250	Green (RoHS & no Sb/Br)	CU NIPDAU	Level-1-260C-UNLIM		RO1N	<a href="#">Samples</a>
REG101NA-2.85/3K	ACTIVE	SOT-23	DBV	5	3000	Green (RoHS & no Sb/Br)	CU NIPDAU	Level-1-260C-UNLIM		RO1N	<a href="#">Samples</a>
REG101NA-3.3/250	ACTIVE	SOT-23	DBV	5	250	Green (RoHS & no Sb/Br)	CU NIPDAU	Level-1-260C-UNLIM		RO1C	<a href="#">Samples</a>
REG101NA-3.3/250G4	ACTIVE	SOT-23	DBV	5	250	Green (RoHS & no Sb/Br)	CU NIPDAU	Level-1-260C-UNLIM		RO1C	<a href="#">Samples</a>
REG101NA-3.3/3K	ACTIVE	SOT-23	DBV	5	3000	Green (RoHS & no Sb/Br)	CU NIPDAU	Level-1-260C-UNLIM		RO1C	<a href="#">Samples</a>
REG101NA-3.3/3KG4	ACTIVE	SOT-23	DBV	5	3000	Green (RoHS & no Sb/Br)	CU NIPDAU	Level-1-260C-UNLIM		RO1C	<a href="#">Samples</a>
REG101NA-3/250	ACTIVE	SOT-23	DBV	5	250	Green (RoHS & no Sb/Br)	CU NIPDAU	Level-1-260C-UNLIM		R01D	<a href="#">Samples</a>
REG101NA-3/250G4	ACTIVE	SOT-23	DBV	5	250	Green (RoHS & no Sb/Br)	CU NIPDAU	Level-1-260C-UNLIM		R01D	<a href="#">Samples</a>
REG101NA-3/3K	ACTIVE	SOT-23	DBV	5	3000	Green (RoHS & no Sb/Br)	CU NIPDAU	Level-1-260C-UNLIM		R01D	<a href="#">Samples</a>
REG101NA-3/3KG4	ACTIVE	SOT-23	DBV	5	3000	Green (RoHS & no Sb/Br)	CU NIPDAU	Level-1-260C-UNLIM		R01D	<a href="#">Samples</a>
REG101NA-5/250	ACTIVE	SOT-23	DBV	5	250	Green (RoHS & no Sb/Br)	CU NIPDAU	Level-1-260C-UNLIM		RO1B	<a href="#">Samples</a>
REG101NA-5/250G4	ACTIVE	SOT-23	DBV	5	250	Green (RoHS & no Sb/Br)	CU NIPDAU	Level-1-260C-UNLIM		RO1B	<a href="#">Samples</a>
REG101NA-5/3K	ACTIVE	SOT-23	DBV	5	3000	Green (RoHS & no Sb/Br)	CU NIPDAU	Level-1-260C-UNLIM		RO1B	<a href="#">Samples</a>

Orderable Device	Status (1)	Package Type	Package Drawing	Pins	Package Qty	Eco Plan (2)	Lead/Ball Finish (6)	MSL Peak Temp (3)	Op Temp (°C)	Device Marking (4/5)	Samples
REG101NA-5/3KG4	ACTIVE	SOT-23	DBV	5	3000	Green (RoHS & no Sb/Br)	CU NIPDAU	Level-1-260C-UNLIM		RO1B	<a href="#">Samples</a>
REG101NA-A/250	ACTIVE	SOT-23	DBV	5	250	Green (RoHS & no Sb/Br)	CU NIPDAU	Level-1-260C-UNLIM		RO1A	<a href="#">Samples</a>
REG101NA-A/250G4	ACTIVE	SOT-23	DBV	5	250	Green (RoHS & no Sb/Br)	CU NIPDAU	Level-1-260C-UNLIM		RO1A	<a href="#">Samples</a>
REG101NA-A/3K	ACTIVE	SOT-23	DBV	5	3000	Green (RoHS & no Sb/Br)	CU NIPDAU	Level-1-260C-UNLIM		RO1A	<a href="#">Samples</a>
REG101NA-A/3KG4	ACTIVE	SOT-23	DBV	5	3000	Green (RoHS & no Sb/Br)	CU NIPDAU	Level-1-260C-UNLIM		RO1A	<a href="#">Samples</a>
REG101UA-2.5	ACTIVE	SOIC	D	8	75	Green (RoHS & no Sb/Br)	CU NIPDAU	Level-2-260C-1 YEAR		REG 101U25	<a href="#">Samples</a>
REG101UA-2.5G4	ACTIVE	SOIC	D	8	75	Green (RoHS & no Sb/Br)	CU NIPDAU	Level-2-260C-1 YEAR		REG 101U25	<a href="#">Samples</a>
REG101UA-2.8	ACTIVE	SOIC	D	8	75	Green (RoHS & no Sb/Br)	CU NIPDAU	Level-2-260C-1 YEAR		REG 101U28	<a href="#">Samples</a>
REG101UA-2.8/2K5	OBSOLETE	SOIC	D	8		TBD	Call TI	Call TI			
REG101UA-2.8/2K5G4	OBSOLETE	SOIC	D	8		TBD	Call TI	Call TI			
REG101UA-2.85	ACTIVE	SOIC	D	8	75	Green (RoHS & no Sb/Br)	CU NIPDAU	Level-2-260C-1 YEAR		REG 101285	<a href="#">Samples</a>
REG101UA-3	ACTIVE	SOIC	D	8	75	Green (RoHS & no Sb/Br)	CU NIPDAU	Level-2-260C-1 YEAR		REG 101U30	<a href="#">Samples</a>
REG101UA-3.3	ACTIVE	SOIC	D	8	75	Green (RoHS & no Sb/Br)	CU NIPDAU	Level-2-260C-1 YEAR		REG 101U33	<a href="#">Samples</a>
REG101UA-3.3/2K5	ACTIVE	SOIC	D	8	2500	Green (RoHS & no Sb/Br)	CU NIPDAU	Level-2-260C-1 YEAR		REG 101U33	<a href="#">Samples</a>
REG101UA-3.3G4	ACTIVE	SOIC	D	8	75	Green (RoHS & no Sb/Br)	CU NIPDAU	Level-2-260C-1 YEAR		REG 101U33	<a href="#">Samples</a>
REG101UA-3G4	ACTIVE	SOIC	D	8	75	Green (RoHS & no Sb/Br)	CU NIPDAU	Level-2-260C-1 YEAR		REG 101U30	<a href="#">Samples</a>
REG101UA-5	ACTIVE	SOIC	D	8	75	Green (RoHS & no Sb/Br)	CU NIPDAU	Level-2-260C-1 YEAR		REG 101U50	<a href="#">Samples</a>
REG101UA-5/2K5	ACTIVE	SOIC	D	8	2500	Green (RoHS & no Sb/Br)	CU NIPDAU	Level-2-260C-1 YEAR		REG 101U50	<a href="#">Samples</a>
REG101UA-5/2K5G4	ACTIVE	SOIC	D	8	2500	Green (RoHS & no Sb/Br)	CU NIPDAU	Level-2-260C-1 YEAR		REG 101U50	<a href="#">Samples</a>

Orderable Device	Status (1)	Package Type	Package Drawing	Pins	Package Qty	Eco Plan (2)	Lead/Ball Finish (6)	MSL Peak Temp (3)	Op Temp (°C)	Device Marking (4/5)	Samples
REG101UA-5G4	ACTIVE	SOIC	D	8	75	Green (RoHS & no Sb/Br)	CU NIPDAU	Level-2-260C-1 YEAR		REG 101U50	<a href="#">Samples</a>
REG101UA-A	ACTIVE	SOIC	D	8	75	Green (RoHS & no Sb/Br)	CU NIPDAU	Level-2-260C-1 YEAR		REG 101UA	<a href="#">Samples</a>
REG101UA-AG4	ACTIVE	SOIC	D	8	75	Green (RoHS & no Sb/Br)	CU NIPDAU	Level-2-260C-1 YEAR		REG 101UA	<a href="#">Samples</a>

(1) The marketing status values are defined as follows:

**ACTIVE:** Product device recommended for new designs.

**LIFEBUY:** TI has announced that the device will be discontinued, and a lifetime-buy period is in effect.

**NRND:** Not recommended for new designs. Device is in production to support existing customers, but TI does not recommend using this part in a new design.

**PREVIEW:** Device has been announced but is not in production. Samples may or may not be available.

**OBSOLETE:** TI has discontinued the production of the device.

(2) Eco Plan - The planned eco-friendly classification: Pb-Free (RoHS), Pb-Free (RoHS Exempt), or Green (RoHS & no Sb/Br) - please check <http://www.ti.com/productcontent> for the latest availability information and additional product content details.

**TBD:** The Pb-Free/Green conversion plan has not been defined.

**Pb-Free (RoHS):** TI's terms "Lead-Free" or "Pb-Free" mean semiconductor products that are compatible with the current RoHS requirements for all 6 substances, including the requirement that lead not exceed 0.1% by weight in homogeneous materials. Where designed to be soldered at high temperatures, TI Pb-Free products are suitable for use in specified lead-free processes.

**Pb-Free (RoHS Exempt):** This component has a RoHS exemption for either 1) lead-based flip-chip solder bumps used between the die and package, or 2) lead-based die adhesive used between the die and leadframe. The component is otherwise considered Pb-Free (RoHS compatible) as defined above.

**Green (RoHS & no Sb/Br):** TI defines "Green" to mean Pb-Free (RoHS compatible), and free of Bromine (Br) and Antimony (Sb) based flame retardants (Br or Sb do not exceed 0.1% by weight in homogeneous material)

(3) MSL, Peak Temp. - The Moisture Sensitivity Level rating according to the JEDEC industry standard classifications, and peak solder temperature.

(4) There may be additional marking, which relates to the logo, the lot trace code information, or the environmental category on the device.

(5) Multiple Device Markings will be inside parentheses. Only one Device Marking contained in parentheses and separated by a "~" will appear on a device. If a line is indented then it is a continuation of the previous line and the two combined represent the entire Device Marking for that device.

(6) Lead/Ball Finish - Orderable Devices may have multiple material finish options. Finish options are separated by a vertical ruled line. Lead/Ball Finish values may wrap to two lines if the finish value exceeds the maximum column width.

**Important Information and Disclaimer:** The information provided on this page represents TI's knowledge and belief as of the date that it is provided. TI bases its knowledge and belief on information provided by third parties, and makes no representation or warranty as to the accuracy of such information. Efforts are underway to better integrate information from third parties. TI has taken and continues to take reasonable steps to provide representative and accurate information but may not have conducted destructive testing or chemical analysis on incoming materials and chemicals. TI and TI suppliers consider certain information to be proprietary, and thus CAS numbers and other limited information may not be available for release.

In no event shall TI's liability arising out of such information exceed the total purchase price of the TI part(s) at issue in this document sold by TI to Customer on an annual basis.

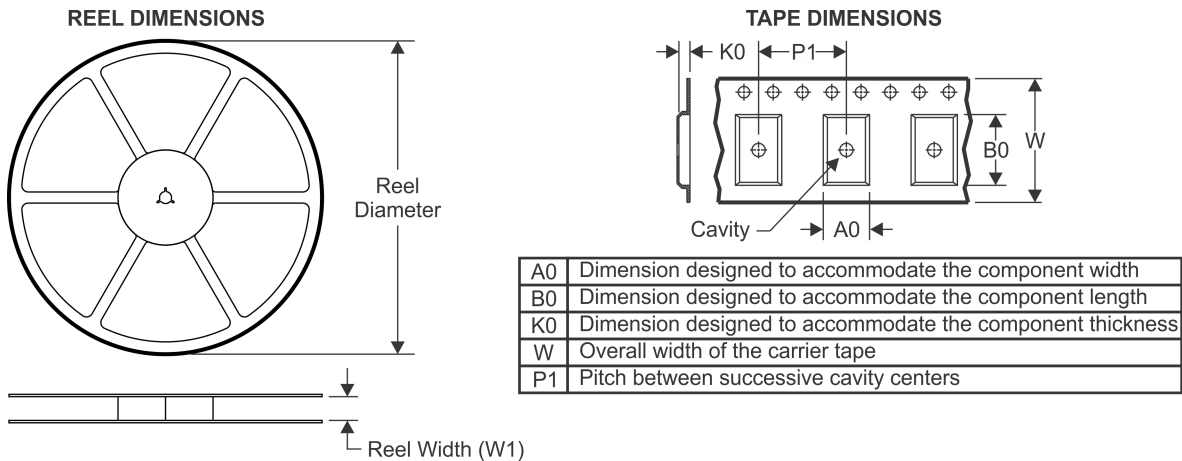
**TAPE AND REEL INFORMATION**

**QUADRANT ASSIGNMENTS FOR PIN 1 ORIENTATION IN TAPE**

\*All dimensions are nominal

Device	Package Type	Package Drawing	Pins	SPQ	Reel Diameter (mm)	Reel Width W1 (mm)	A0 (mm)	B0 (mm)	K0 (mm)	P1 (mm)	W (mm)	Pin1 Quadrant
REG101NA-2.5/250	SOT-23	DBV	5	250	179.0	8.4	3.2	3.2	1.4	4.0	8.0	Q3
REG101NA-2.5/3K	SOT-23	DBV	5	3000	179.0	8.4	3.2	3.2	1.4	4.0	8.0	Q3
REG101NA-2.8/250	SOT-23	DBV	5	250	179.0	8.4	3.2	3.2	1.4	4.0	8.0	Q3
REG101NA-2.85/250	SOT-23	DBV	5	250	179.0	8.4	3.2	3.2	1.4	4.0	8.0	Q3
REG101NA-2.85/3K	SOT-23	DBV	5	3000	179.0	8.4	3.2	3.2	1.4	4.0	8.0	Q3
REG101NA-3.3/250	SOT-23	DBV	5	250	179.0	8.4	3.2	3.2	1.4	4.0	8.0	Q3
REG101NA-3.3/3K	SOT-23	DBV	5	3000	179.0	8.4	3.2	3.2	1.4	4.0	8.0	Q3
REG101NA-3/250	SOT-23	DBV	5	250	179.0	8.4	3.2	3.2	1.4	4.0	8.0	Q3
REG101NA-3/3K	SOT-23	DBV	5	3000	179.0	8.4	3.2	3.2	1.4	4.0	8.0	Q3
REG101NA-5/250	SOT-23	DBV	5	250	179.0	8.4	3.2	3.2	1.4	4.0	8.0	Q3
REG101NA-5/3K	SOT-23	DBV	5	3000	179.0	8.4	3.2	3.2	1.4	4.0	8.0	Q3
REG101NA-A/250	SOT-23	DBV	5	250	179.0	8.4	3.2	3.2	1.4	4.0	8.0	Q3
REG101NA-A/3K	SOT-23	DBV	5	3000	179.0	8.4	3.2	3.2	1.4	4.0	8.0	Q3
REG101UA-3.3/2K5	SOIC	D	8	2500	330.0	12.4	6.4	5.2	2.1	8.0	12.0	Q1
REG101UA-5/2K5	SOIC	D	8	2500	330.0	12.4	6.4	5.2	2.1	8.0	12.0	Q1

**TAPE AND REEL BOX DIMENSIONS**

\*All dimensions are nominal

Device	Package Type	Package Drawing	Pins	SPQ	Length (mm)	Width (mm)	Height (mm)
REG101NA-2.5/250	SOT-23	DBV	5	250	203.0	203.0	35.0
REG101NA-2.5/3K	SOT-23	DBV	5	3000	203.0	203.0	35.0
REG101NA-2.8/250	SOT-23	DBV	5	250	203.0	203.0	35.0
REG101NA-2.85/250	SOT-23	DBV	5	250	203.0	203.0	35.0
REG101NA-2.85/3K	SOT-23	DBV	5	3000	203.0	203.0	35.0
REG101NA-3.3/250	SOT-23	DBV	5	250	203.0	203.0	35.0
REG101NA-3.3/3K	SOT-23	DBV	5	3000	203.0	203.0	35.0
REG101NA-3/250	SOT-23	DBV	5	250	203.0	203.0	35.0
REG101NA-3/3K	SOT-23	DBV	5	3000	203.0	203.0	35.0
REG101NA-5/250	SOT-23	DBV	5	250	203.0	203.0	35.0
REG101NA-5/3K	SOT-23	DBV	5	3000	203.0	203.0	35.0
REG101NA-A/250	SOT-23	DBV	5	250	203.0	203.0	35.0
REG101NA-A/3K	SOT-23	DBV	5	3000	203.0	203.0	35.0
REG101UA-3.3/2K5	SOIC	D	8	2500	367.0	367.0	35.0
REG101UA-5/2K5	SOIC	D	8	2500	367.0	367.0	35.0



DBV (R-PDSO-G5)

PLASTIC SMALL OUTLINE



- NOTES:
- A. All linear dimensions are in millimeters.
  - B. This drawing is subject to change without notice.
  - C. Customers should place a note on the circuit board fabrication drawing not to alter the center solder mask defined pad.
  - D. Publication IPC-7351 is recommended for alternate designs.
  - E. Laser cutting apertures with trapezoidal walls and also rounding corners will offer better paste release. Customers should contact their board assembly site for stencil design recommendations. Example stencil design based on a 50% volumetric metal load solder paste. Refer to IPC-7525 for other stencil recommendations.

D (R-PDSO-G8)

PLASTIC SMALL OUTLINE

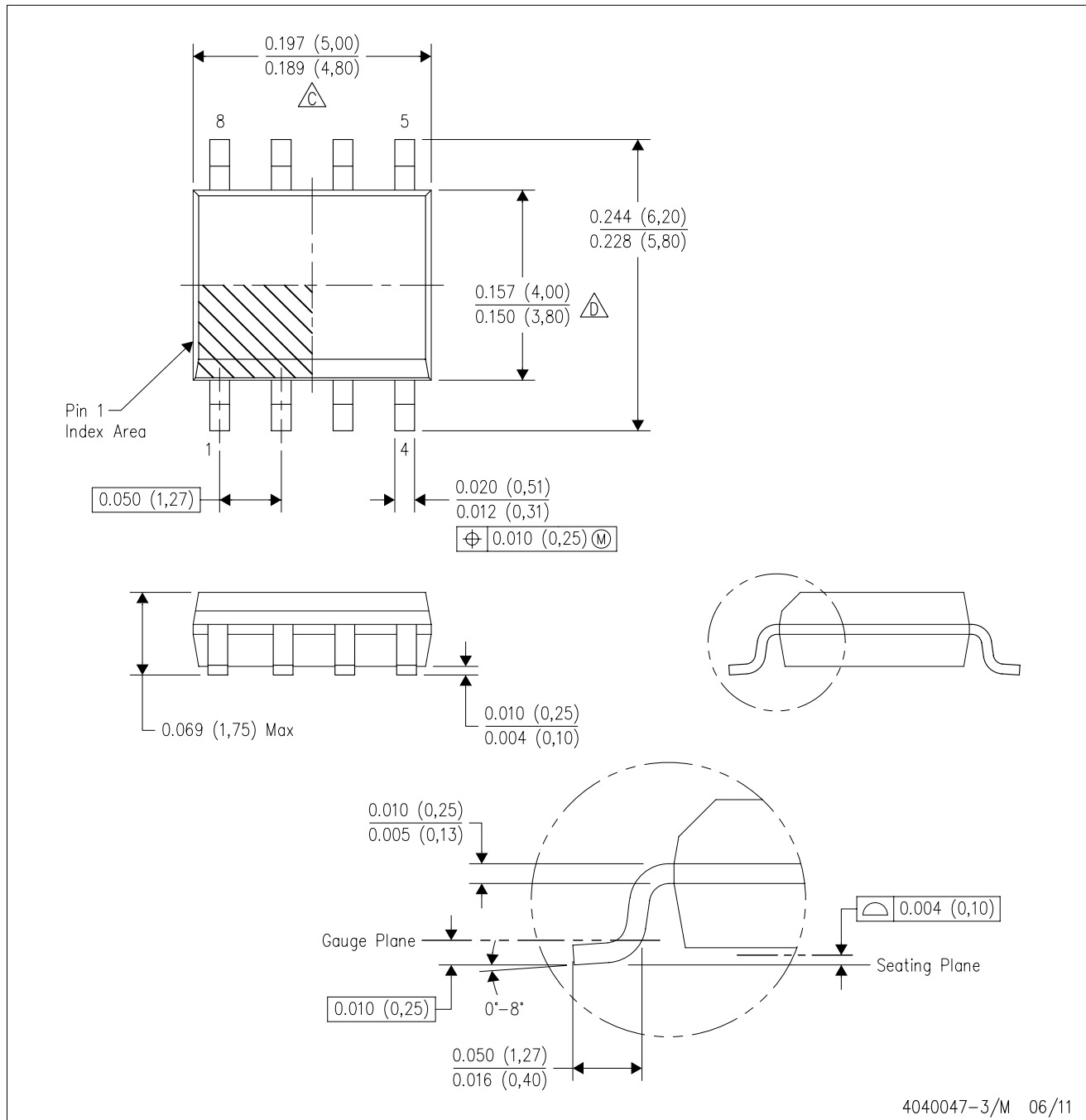

- NOTES:
- A. All linear dimensions are in inches (millimeters).
  - B. This drawing is subject to change without notice.
  - C. Body length does not include mold flash, protrusions, or gate burrs. Mold flash, protrusions, or gate burrs shall not exceed 0.006 (0,15) each side.
  - D. Body width does not include interlead flash. Interlead flash shall not exceed 0.017 (0,43) each side.
  - E. Reference JEDEC MS-012 variation AA.

D (R-PDSO-G8)

PLASTIC SMALL OUTLINE

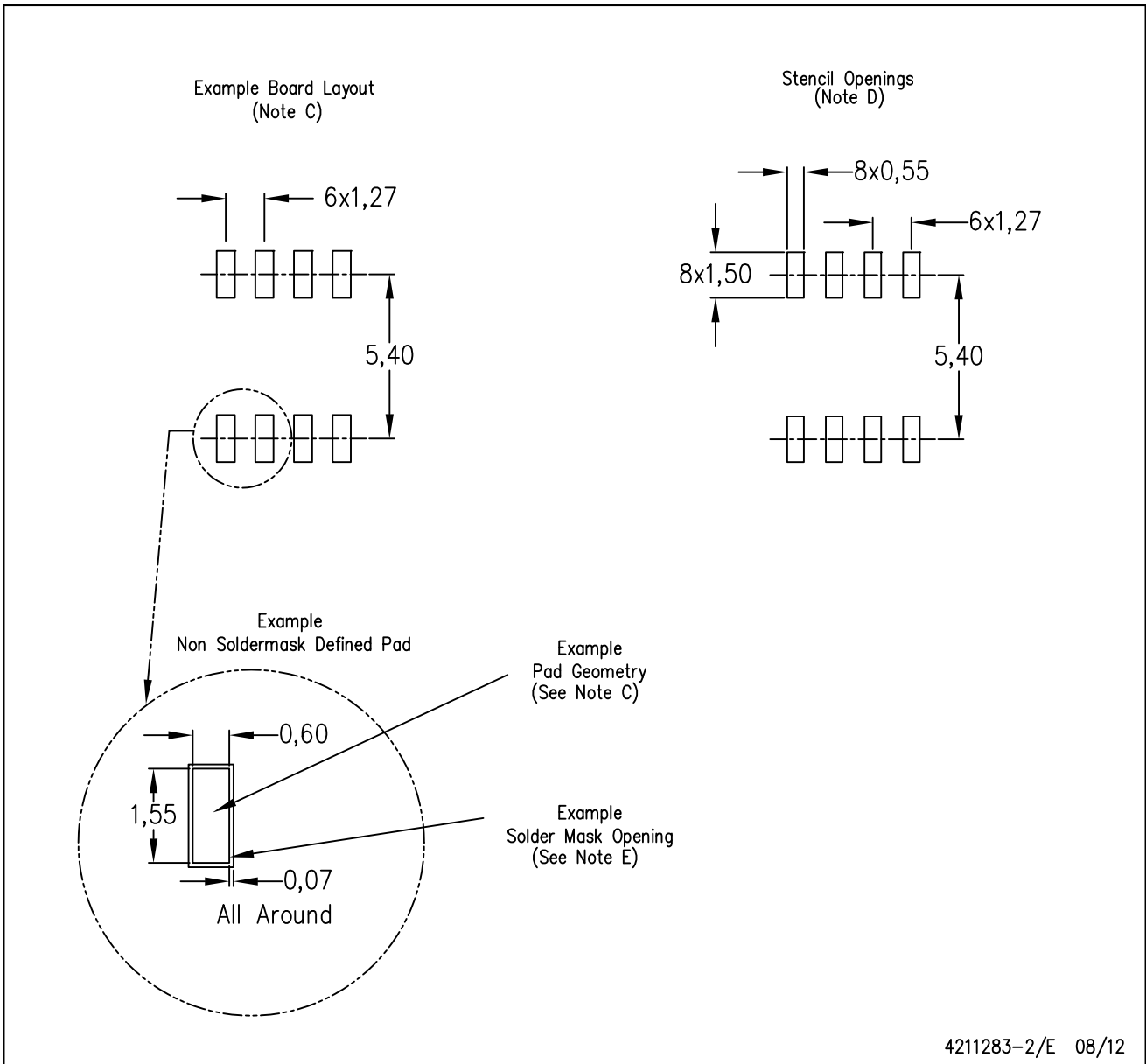

4211283-2/E 08/12

- NOTES:
- A. All linear dimensions are in millimeters.
  - B. This drawing is subject to change without notice.
  - C. Publication IPC-7351 is recommended for alternate designs.
  - D. Laser cutting apertures with trapezoidal walls and also rounding corners will offer better paste release. Customers should contact their board assembly site for stencil design recommendations. Refer to IPC-7525 for other stencil recommendations.
  - E. Customers should contact their board fabrication site for solder mask tolerances between and around signal pads.

## IMPORTANT NOTICE

Texas Instruments Incorporated and its subsidiaries (TI) reserve the right to make corrections, enhancements, improvements and other changes to its semiconductor products and services per JESD46, latest issue, and to discontinue any product or service per JESD48, latest issue. Buyers should obtain the latest relevant information before placing orders and should verify that such information is current and complete. All semiconductor products (also referred to herein as "components") are sold subject to TI's terms and conditions of sale supplied at the time of order acknowledgment.

TI warrants performance of its components to the specifications applicable at the time of sale, in accordance with the warranty in TI's terms and conditions of sale of semiconductor products. Testing and other quality control techniques are used to the extent TI deems necessary to support this warranty. Except where mandated by applicable law, testing of all parameters of each component is not necessarily performed.

TI assumes no liability for applications assistance or the design of Buyers' products. Buyers are responsible for their products and applications using TI components. To minimize the risks associated with Buyers' products and applications, Buyers should provide adequate design and operating safeguards.

TI does not warrant or represent that any license, either express or implied, is granted under any patent right, copyright, mask work right, or other intellectual property right relating to any combination, machine, or process in which TI components or services are used. Information published by TI regarding third-party products or services does not constitute a license to use such products or services or a warranty or endorsement thereof. Use of such information may require a license from a third party under the patents or other intellectual property of the third party, or a license from TI under the patents or other intellectual property of TI.

Reproduction of significant portions of TI information in TI data books or data sheets is permissible only if reproduction is without alteration and is accompanied by all associated warranties, conditions, limitations, and notices. TI is not responsible or liable for such altered documentation. Information of third parties may be subject to additional restrictions.

Resale of TI components or services with statements different from or beyond the parameters stated by TI for that component or service voids all express and any implied warranties for the associated TI component or service and is an unfair and deceptive business practice. TI is not responsible or liable for any such statements.

Buyer acknowledges and agrees that it is solely responsible for compliance with all legal, regulatory and safety-related requirements concerning its products, and any use of TI components in its applications, notwithstanding any applications-related information or support that may be provided by TI. Buyer represents and agrees that it has all the necessary expertise to create and implement safeguards which anticipate dangerous consequences of failures, monitor failures and their consequences, lessen the likelihood of failures that might cause harm and take appropriate remedial actions. Buyer will fully indemnify TI and its representatives against any damages arising out of the use of any TI components in safety-critical applications.

In some cases, TI components may be promoted specifically to facilitate safety-related applications. With such components, TI's goal is to help enable customers to design and create their own end-product solutions that meet applicable functional safety standards and requirements. Nonetheless, such components are subject to these terms.

No TI components are authorized for use in FDA Class III (or similar life-critical medical equipment) unless authorized officers of the parties have executed a special agreement specifically governing such use.

Only those TI components which TI has specifically designated as military grade or "enhanced plastic" are designed and intended for use in military/aerospace applications or environments. Buyer acknowledges and agrees that any military or aerospace use of TI components which have **not** been so designated is solely at the Buyer's risk, and that Buyer is solely responsible for compliance with all legal and regulatory requirements in connection with such use.

TI has specifically designated certain components as meeting ISO/TS16949 requirements, mainly for automotive use. In any case of use of non-designated products, TI will not be responsible for any failure to meet ISO/TS16949.

### Products

Audio	<a href="http://www.ti.com/audio">www.ti.com/audio</a>
Amplifiers	<a href="http://amplifier.ti.com">amplifier.ti.com</a>
Data Converters	<a href="http://dataconverter.ti.com">dataconverter.ti.com</a>
DLP® Products	<a href="http://www.dlp.com">www.dlp.com</a>
DSP	<a href="http://dsp.ti.com">dsp.ti.com</a>
Clocks and Timers	<a href="http://www.ti.com/clocks">www.ti.com/clocks</a>
Interface	<a href="http://interface.ti.com">interface.ti.com</a>
Logic	<a href="http://logic.ti.com">logic.ti.com</a>
Power Mgmt	<a href="http://power.ti.com">power.ti.com</a>
Microcontrollers	<a href="http://microcontroller.ti.com">microcontroller.ti.com</a>
RFID	<a href="http://www.ti-rfid.com">www.ti-rfid.com</a>
OMAP Applications Processors	<a href="http://www.ti.com/omap">www.ti.com/omap</a>
Wireless Connectivity	<a href="http://www.ti.com/wirelessconnectivity">www.ti.com/wirelessconnectivity</a>

### Applications

Automotive and Transportation	<a href="http://www.ti.com/automotive">www.ti.com/automotive</a>
Communications and Telecom	<a href="http://www.ti.com/communications">www.ti.com/communications</a>
Computers and Peripherals	<a href="http://www.ti.com/computers">www.ti.com/computers</a>
Consumer Electronics	<a href="http://www.ti.com/consumer-apps">www.ti.com/consumer-apps</a>
Energy and Lighting	<a href="http://www.ti.com/energy">www.ti.com/energy</a>
Industrial	<a href="http://www.ti.com/industrial">www.ti.com/industrial</a>
Medical	<a href="http://www.ti.com/medical">www.ti.com/medical</a>
Security	<a href="http://www.ti.com/security">www.ti.com/security</a>
Space, Avionics and Defense	<a href="http://www.ti.com/space-avionics-defense">www.ti.com/space-avionics-defense</a>
Video and Imaging	<a href="http://www.ti.com/video">www.ti.com/video</a>

### TI E2E Community

[e2e.ti.com](http://e2e.ti.com)