

3-A, WIDE-INPUT ADJUSTABLE SWITCHING REGULATOR

FEATURES

- 3-A Output Current
- Wide-Input Voltage (7 V to 36 V) / (15 V to 36 V)
- Wide-Output Voltage Adjust (2.5 V to 12.6 V) / (11.85 V to 22 V)
- High Efficiency (Up to 96%)
- On/Off Inhibit
- Under-Voltage Lockout
- Output Current Limit
- Overtemperature Shutdown
- Operating Temperature: -40°C to 85°C
- Surface Mount Package Available

APPLICATIONS

- General-Purpose, Industrial Controls, HVAC Systems
- Test and Measurement, Medical Instrumentation
- AC/DC Adaptors, Vehicles, Marine, and Avionics



DESCRIPTION

The PTN78060 is a series of high-efficiency, step-down integrated switching regulators (ISR), that represent the third generation in the evolution of the popular (PT)78ST200, 78ST300, (PT)78HT200, and 78HT300 series of products. In new designs, the PTN78060 series may also be considered in place of the PT6200, PT6210, and PT6300 series of single in-line pin (SIP) products. In all cases, the PTN78060 has either similar or improved electrical performance characteristics. The caseless, double-sided package has excellent thermal characteristics, and is compatible with TI's roadmap for RoHS and lead-free compliance.

Operating from a wide-input voltage range, the PTN78060 provides high-efficiency, step-down voltage conversion for loads of up to 3 A. The output voltage can be set to any value over a wide adjustment range using a single external resistor. The PTN78060W may be set to any value within the range, 2.5 V to 12.6 V, and the PTN78060H from 11.85 V to 22 V. The output voltage of the PTN78060W can be as little as 2 V lower than the input, allowing operation down to 7 V, with an output voltage of 5 V. The output voltage of the PTN78060H can be as little as 3 V lower than the input, allowing operation down to 15 V, with an output voltage of 12 V.

The PTN78060 has undervoltage lockout, an integral on/off inhibit, and includes an output current limit and overtemperature protection. It is well suited to a wide variety of general-purpose applications that operate off 12-V, 24-V, or 28-V DC power.

STANDARD APPLICATION

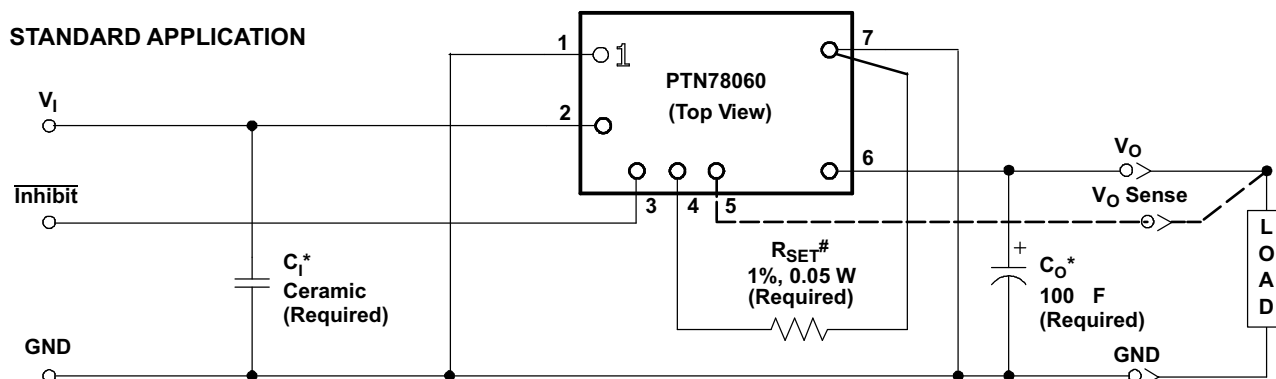

*See the *Application Information* section for capacitor recommendations. The minimum input capacitance is 2.2 F for PTN78060W, and 14.1 F (3 x 4.7 F) for PTN78060H.

#R_{SET} is required to adjust the output voltage. See the *Application Information* section for Values.



Please be aware that an important notice concerning availability, standard warranty, and use in critical applications of Texas Instruments semiconductor products and disclaimers thereto appears at the end of this data sheet.



These devices have limited built-in ESD protection. The leads should be shorted together or the device placed in conductive foam during storage or handling to prevent electrostatic damage to the MOS gates.

ORDERING INFORMATION

PTN78060 (Basic Model)			
Output Voltage	Part Number	Description	Package Designator
2.5 V - 12.6 V	PTN78060WAH	Horizontal T/H	EUW-7
	PTN78060WAS ⁽¹⁾⁽²⁾	Horizontal SMD	EUY-7
	PTN78060WAZ ⁽³⁾⁽²⁾		
11.85 V - 22 V	PTN78060HAH	Horizontal T/H	EUW-7
	PTN78060HAS ⁽¹⁾⁽²⁾	Horizontal SMD	EUY-7
	PTN78060HAZ ⁽³⁾⁽²⁾		

- (1) *Standard option* specifies Sn/Pb pin solder ball material.
- (2) Add a T suffix for tape and reel option on SMD packages.
- (3) *Pb-free option* specifies Sn/Ag pin solder ball material.

ABSOLUTE MAXIMUM RATINGS ⁽¹⁾

over operating free-air temperature range unless otherwise noted
all voltages with respect to GND

			UNIT
T _A	Operating free-air temperature	Over V _I range	–40°C to 85°C
	Solder reflow temperature	Surface temperature of module body or pins	Horizontal SMD (suffix AS) 235°C
			Horizontal SMD (suffix AZ) 260°C
T _{stg}	Storage temperature		–40°C to 125°C
V _I	Input surge voltage, 10 ms maximum		38 V
V _(Inhibit)	Inhibit (pin 3) input voltage		–0.3 V to 5 V
P _O	Output power	V _O ≥ 15 V	45 W

- (1) Stresses beyond those listed under absolute maximum ratings may cause permanent damage to the device. These are stress ratings only, and functional operation of the device at these or any other conditions beyond those indicated under recommended operating conditions is not implied. Exposure to absolute-maximum-rated conditions for extended periods may affect device reliability.

RECOMMENDED OPERATING CONDITIONS

		MIN	MAX	UNIT
V _I	Input voltage	PTN78060W	7	36
		PTN78060H	15	36
T _A	Operating free-air temperature	–40	85	°C

PACKAGE SPECIFICATIONS

PTN78060x (Suffix AH, AS, and AZ)			
Weight			3.9 grams
Flammability	Meets UL 94 V-O		
Mechanical shock	Per Mil-STD-883D, Method 2002.3, 1 ms, 1/2 sine, mounted		500 Gs ⁽¹⁾
Mechanical vibration	Mil-STD-883D, Method 2007.2, 20-2000 Hz	Horizontal T/H (suffix AH)	20 Gs ⁽¹⁾
		Horizontal SMD (suffix AS and AZ)	20 Gs ⁽¹⁾

- (1) Qualification limit.

ELECTRICAL CHARACTERISTICS

 operating at 25°C free-air temperature, $V_I = 20\text{ V}$, $V_O = 5\text{ V}$, $I_O = I_O(\text{max})$, $C_I = 2.2\ \mu\text{F}$, $C_O = 100\ \mu\text{F}$ (unless otherwise noted)

PARAMETER		TEST CONDITIONS	PTN78060W			
			MIN	TYP	MAX	UNIT
I_O	Output current	$T_A = 85^\circ\text{C}$, natural convection airflow	0		3	A
V_I	Input voltage range	Over I_O range	7 ⁽¹⁾		36 ⁽²⁾	V
V_O	Set-point voltage tolerance	$T_A = 25^\circ\text{C}$			$\pm 2\%$ ⁽³⁾	
	Temperature variation	-40°C to $+85^\circ\text{C}$		$\pm 0.5\%$		
	Line regulation	Over V_I range		± 10		mV
	Load regulation	Over I_O range		± 10		mV
	Total output voltage variation	Includes set point, line, load $-40 < T_A < 85^\circ\text{C}$			$\pm 3\%$ ⁽³⁾	
$V_O(\text{adj})$	Output voltage adjust range	$V_I < 12\text{ V}$	2.5		$V_I - 2$	V
		$12\text{ V} \leq V_I \leq 15.1\text{ V}$	2.5		$V_I - 2.5$	
		$15.1\text{ V} < V_I \leq 25\text{ V}$	2.5		12.6	
		$V_I > 25\text{ V}$	$0.1 \times V_I$		12.6	
η	Efficiency	$V_I = 24\text{ V}$, $I_O = 3\text{ A}$ $R_{\text{SET}} = 732\ \Omega$, $V_O = 12\text{ V}$		94%		
		$R_{\text{SET}} = 21\text{ k}\Omega$, $V_O = 5\text{ V}$		86%		
		$R_{\text{SET}} = 78.7\text{ k}\Omega$, $V_O = 3.3\text{ V}$		82%		
	Output voltage ripple	20-MHz bandwidth		$1\% V_O$		$V_{(\text{PP})}$
$I_O(\text{LIM})$	Current limit threshold	$\Delta V_O = -50\text{ mV}$		5.5		A
	Transient response	1-A/ μs load step from 50% to 100% I_{Omax}				
		Recovery time		100		μs
		V_O over/undershoot		5		$\%V_O$
Inhibit control (pin 3)	Input high voltage (V_{IH})		1		Open ⁽⁴⁾	V
	Input low voltage (V_{IL})		-0.1		0.3	
	Input low current (I_{IL})			-0.25		
$I_{\text{I(stby)}}$	Input standby current	Pin 3 connected to GND		17		mA
F_S	Switching frequency	Over V_I and I_O ranges	440	550	660	kHz
C_I	External input capacitance		2.2 ⁽⁵⁾			μF
C_O	External output capacitance	Ceramic or nonceramic	100 ⁽⁶⁾			μF
		Ceramic			200	
		Nonceramic			2,000	
		Equivalent series resistance (nonceramic)	17 ⁽⁷⁾			m Ω
MTBF	Calculated reliability	Per Telcordia SR-332, 50% stress, $T_A = 40^\circ\text{C}$, ground benign	8.9			10^6 Hr

- (1) For output voltages less than 10 V, the minimum input voltage is 7 V or $(V_O + 2)\text{ V}$, whichever is greater. For output voltages of 10 V and higher, the minimum input voltage is $(V_O + 2.5)\text{ V}$. See the Application Information section for further guidance.
- (2) For output voltages less than 3.6 V, the maximum input voltage is $10 \times V_O$. See the Application Information section for further guidance.
- (3) The set-point voltage tolerance is affected by the tolerance and stability of R_{SET} . The stated limit is unconditionally met if R_{SET} has a tolerance of 1% with 100 ppm/ $^\circ\text{C}$ or better temperature stability.
- (4) This control pin has an internal pullup, and if left open-circuit, the module operates when input power is applied. The open-circuit voltage is typically 1.5 V. A small, low-leakage ($< 100\text{ nA}$) MOSFET is recommended for control. An external pull-up resistor should not be used. See the Application Information section for further guidance.
- (5) An external 2.2- μF ceramic capacitor is required across the input (V_I and GND) for proper operation. Locate the capacitor close to the module.
- (6) 100 μF of output capacitance is required for proper operation. See the Application Information section for further guidance.
- (7) This is the typical ESR for all the electrolytic (nonceramic) capacitance. Use 17 m Ω as the minimum when using max-ESR values to calculate.

ELECTRICAL CHARACTERISTICS

operating at 25°C free-air temperature, $V_I = 24$ V, $V_O = 12$ V, $I_O = I_O$ (max), $C_I = 3 \times 4.7$ μ F, $C_O = 100$ μ F (unless otherwise noted)

PARAMETER		TEST CONDITIONS		PTN78060H			
				MIN	TYP	MAX	UNIT
I_O	Output current	$T_A = 85^\circ\text{C}$, natural convection airflow	$V_O = 12$ V	0		3 ⁽¹⁾	A
			$V_O = 15$ V	0		3 ⁽¹⁾	
			$V_O = 22$ V	0		2 ⁽¹⁾	
V_I	Input voltage range	Over I_O range		15 ⁽²⁾		36	V
V_O	Set-point voltage tolerance	$T_A = 25^\circ\text{C}$				$\pm 2\%$ ⁽³⁾	
	Temperature variation	-40°C to $+85^\circ\text{C}$			$\pm 0.5\%$		
	Line regulation	Over V_I range			± 10		mV
	Load regulation	Over I_O range			± 10		mV
	Total output voltage variation	Includes set point, line, load $-40 < T_A < 85^\circ\text{C}$					$\pm 3\%$ ⁽³⁾
V_O (adj)	Output voltage adjust range		$V_I < 19$ V	11.85		$V_I - 3$	V
			$19 \text{ V} \leq V_I \leq 25$ V	11.85		$V_I - 4$	
			$V_I \geq 26$ V	11.85		22	
η	Efficiency		$V_I = 24$ V, $R_{\text{SET}} = 383$ k Ω , $V_O = 12$ V			93%	
			$V_I = 24$ V, $R_{\text{SET}} = 15$ k Ω , $V_O = 15$ V			95%	
			$I_O = 2$ A, $V_I = 32$ V, $R_{\text{SET}} = 95.3$ Ω , $V_O = 22$ V,			96%	
	Output voltage ripple	20-MHz bandwidth			1.2% V_O		$V_{(\text{PP})}$
$I_{O(\text{LIM})}$	Current limit threshold	$\Delta V_O = -50$ mV			5.5		A
	Transient response	1-A/ μ s load step from 50% to 100% $I_{O(\text{max})}$	Recovery time			100	μ s
			V_O over/undershoot			5	% V_O
	Inhibit control (pin 3)	Input high voltage (V_{IH})	1		Open ⁽⁴⁾		V
		Input low voltage (V_{IL})	-0.1		0.3		
		Input low current (I_{IL})			-0.25		mA
$I_{\text{I(stby)}}$	Input standby current	Pin 3 connected to GND			17		mA
F_S	Switching frequency	Over V_I and I_O ranges		440	550	660	kHz
C_I	External input capacitance	Ceramic or nonceramic		14.1 ⁽⁵⁾			μ F
C_O	External output capacitance	Ceramic		0		200	μ F
		Nonceramic		100 ⁽⁶⁾		2,000	
		Equivalent series resistance (nonceramic)		10 ⁽⁷⁾			m Ω
MTBF	Calculated reliability	Per Telcordia SR-332, 50% stress, $T_A = 40^\circ\text{C}$, ground benign		8.9			10^6 Hr

- (1) The maximum output current is 3 amps or a maximum output power of 45 W, whichever is less. See the Application Information section for further guidance.
- (2) For output voltages less than 19 V, the minimum input voltage is 15 V or $(V_O + 3)$ V, whichever is greater. For output voltages of 19 V and higher, the minimum input voltage is $(V_O + 4)$ V. See the Application Information for further guidance.
- (3) The set-point voltage tolerance is affected by the tolerance and stability of R_{SET} . The stated limit is unconditionally met if R_{SET} has a tolerance of 1% with 100 ppm/ $^\circ\text{C}$ or better temperature stability.
- (4) This control pin has an internal pullup, and if left open-circuit, the module operates when input power is applied. The open-circuit voltage is typically 1.5 V. A small, low-leakage (< 100 nA) MOSFET is recommended for control. See the Application Information section for further guidance.
- (5) Three external 4.7- μ F ceramic capacitors are required across the input (V_I and GND) for proper operation. Locate the capacitor close to the module.
- (6) 100 μ F of output capacitance is required for proper operation. See the Application Information section for further guidance.
- (7) This is the typical ESR for all the electrolytic (nonceramic) capacitance. Use 17 m Ω as the minimum when using max-ESR values to calculate.

PIN ASSIGNMENT

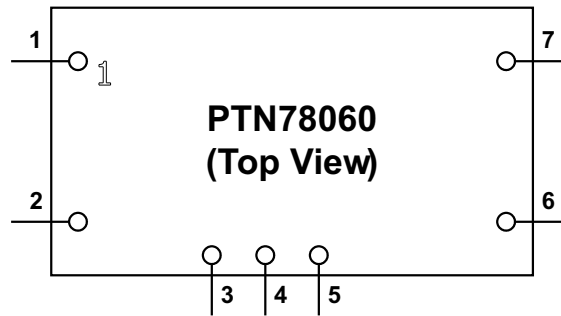

TERMINAL FUNCTIONS

TERMINAL		I/O	DESCRIPTION
NAME	NO.		
GND	1, 7		This is the common ground connection for the V_I and V_O power connections. It is also the 0-VDC reference for the <i>Inhibit</i> and V_O <i>Adjust</i> control inputs.
V_I	2	I	The positive input voltage power node to the module, which is referenced to common GND.
$\overline{\text{Inhibit}}$	3	I	The Inhibit pin is an open-collector/drain active-low input that is referenced to GND. Applying a low-level ground signal to this input disables the module's output and turns off the output voltage. When the Inhibit control is active, the input current drawn by the regulator is significantly reduced. If the Inhibit pin is left open-circuit, the module produces an output whenever a valid input source is applied.
V_O Adjust	4	I	A 1% resistor must be connected between this pin and GND (pin 7) to set the output voltage. If left open-circuit, the output voltage is set to a default value. The temperature stability of the resistor should be 100 ppm/°C (or better). The standard resistor value for a number of common output voltages is provided in the application information.
V_O Sense	5	I	The sense input allows the regulation circuit to compensate for voltage drop between the module and the load. For optimum voltage accuracy, V_O Sense should be connected to V_O . If the sense feature is not used, this pin may be left disconnected.
V_O	6	O	The regulated positive power output with respect to the GND node.

TYPICAL CHARACTERISTICS (7-V INPUT)⁽¹⁾⁽²⁾

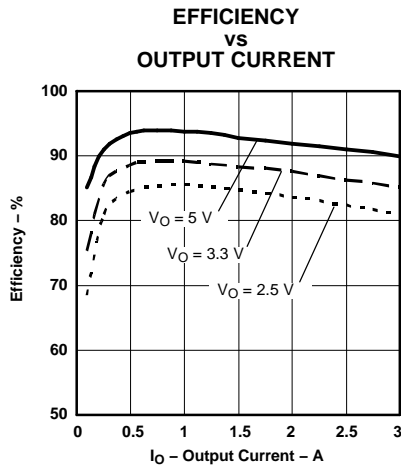

Figure 1.

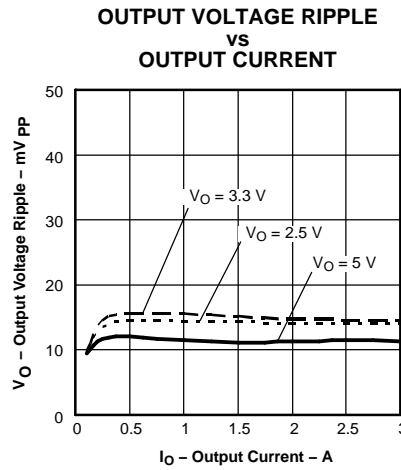

Figure 2.

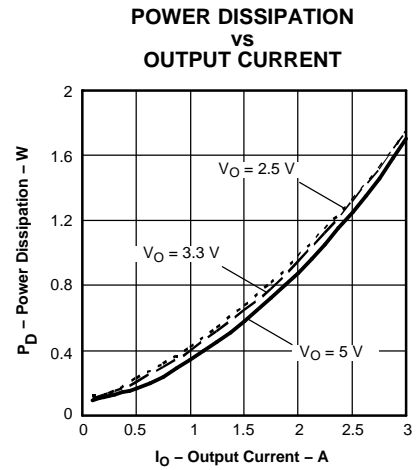

Figure 3.

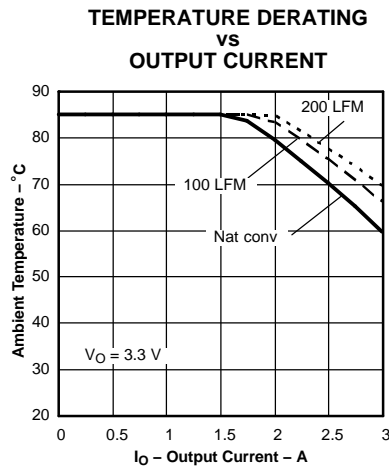

Figure 4.

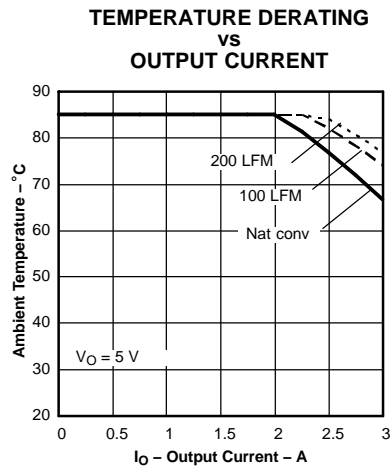

Figure 5.

- (1) The electrical characteristic data has been developed from actual products tested at 25° C. This data is considered typical for the converter. Applies to [Figure 1](#), [Figure 2](#), and [Figure 3](#).
- (2) The temperature derating curves represent the conditions at which internal components are at or below the manufacturer's maximum operating temperatures. Derating limits apply to modules soldered directly to a 100 mm x 100 mm, double-sided PCB with 2 oz. copper. Applies to [Figure 4](#) and [Figure 5](#).

TYPICAL CHARACTERISTICS (15-V INPUT)⁽¹⁾⁽²⁾

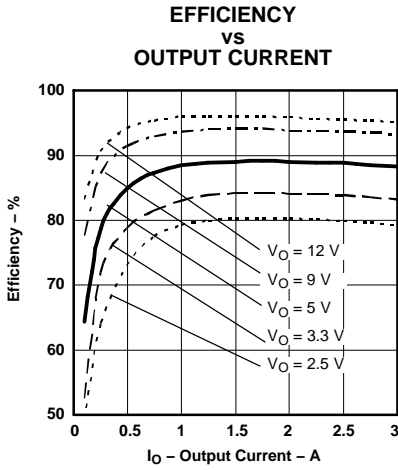

Figure 6.

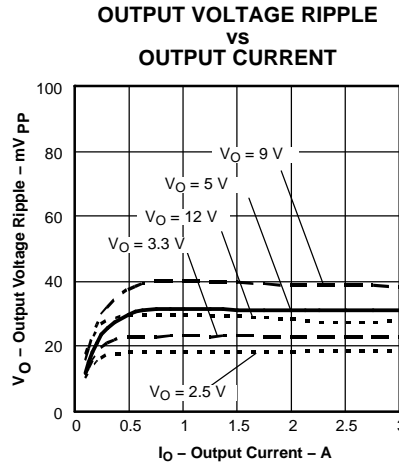

Figure 7.

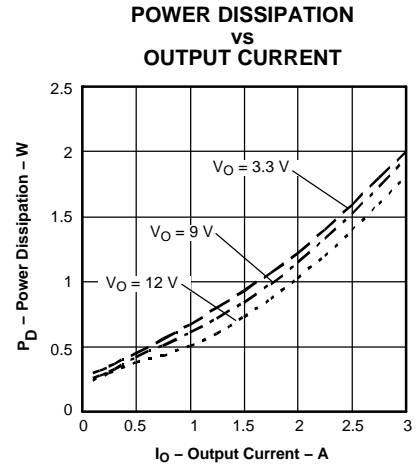

Figure 8.

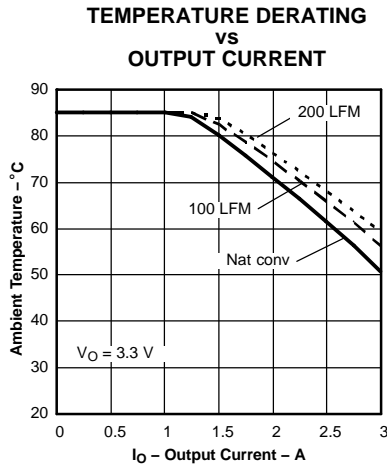

Figure 9.

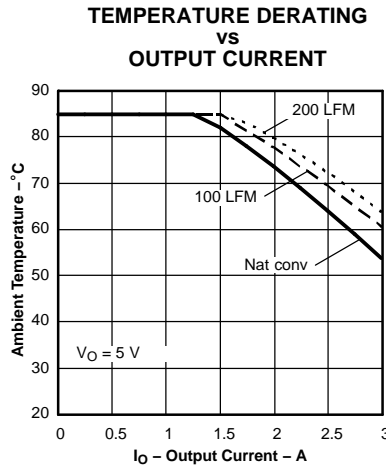

Figure 10.

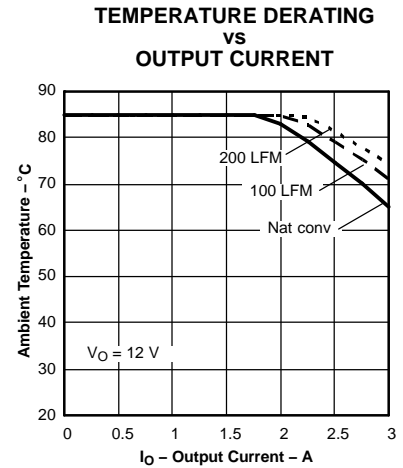

Figure 11.

- (1) The electrical characteristic data has been developed from actual products tested at 25° C. This data is considered typical for the converter. Applies to [Figure 6](#), [Figure 7](#), and [Figure 8](#).
- (2) The temperature derating curves represent the conditions at which internal components are at or below the manufacturer's maximum operating temperatures. Derating limits apply to modules soldered directly to a 100 mm x 100 mm, double-sided PCB with 2 oz. copper. Applies to [Figure 9](#) through [Figure 11](#).

TYPICAL CHARACTERISTICS (24-V INPUT)⁽¹⁾⁽²⁾

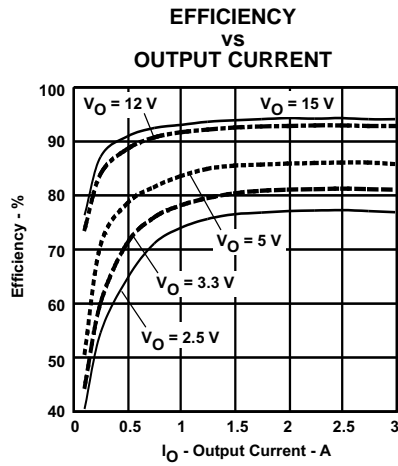

Figure 12.

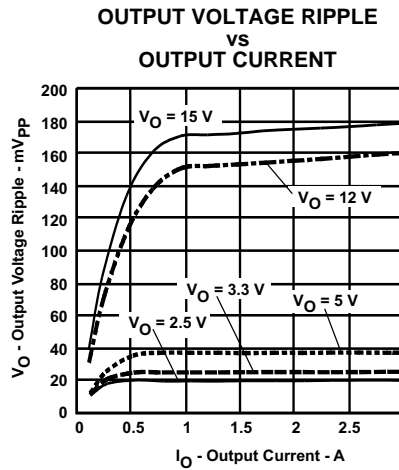

Figure 13.

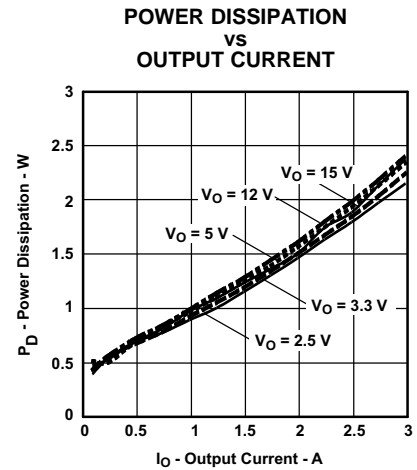

Figure 14.

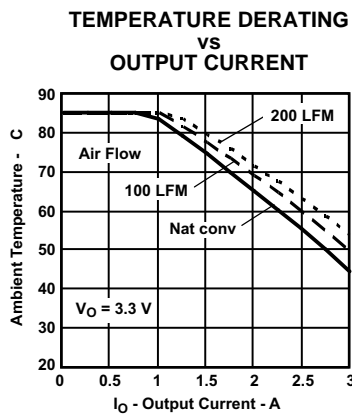

Figure 15.

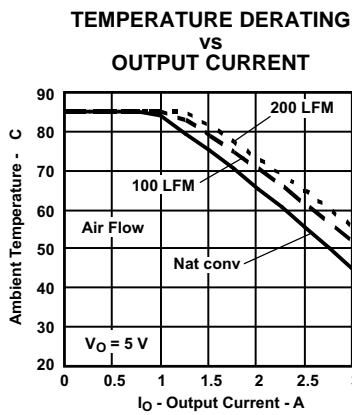

Figure 16.

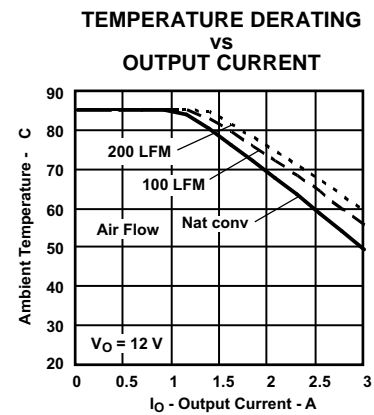

Figure 17.

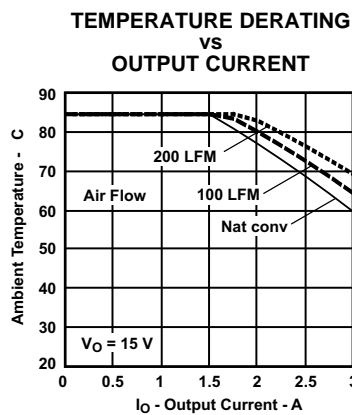

Figure 18.

- (1) The electrical characteristic data has been developed from actual products tested at 25° C. This data is considered typical for the converter. Applies to [Figure 12](#), [Figure 13](#), and [Figure 14](#).
- (2) The temperature derating curves represent the conditions at which internal components are at or below the manufacturer's maximum operating temperatures. Derating limits apply to modules soldered directly to a 100 mm x 100 mm, double-sided PCB with 2 oz. copper. Applies to [Figure 15](#) through [Figure 18](#).

TYPICAL CHARACTERISTICS (32-V INPUT)⁽¹⁾⁽²⁾

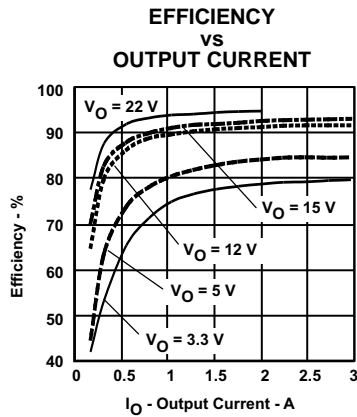

Figure 19.

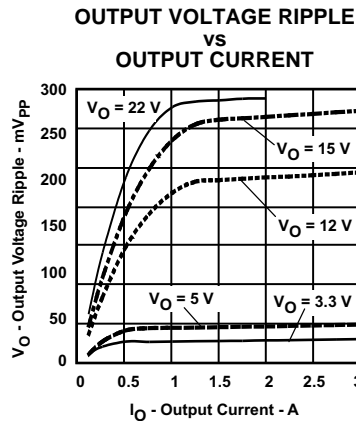

Figure 20.

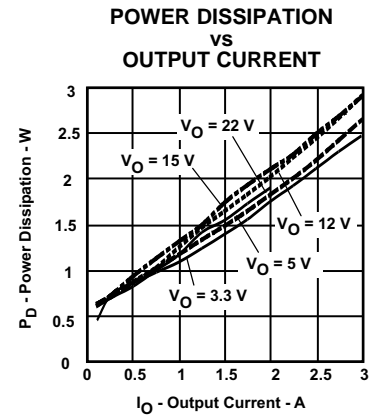

Figure 21.

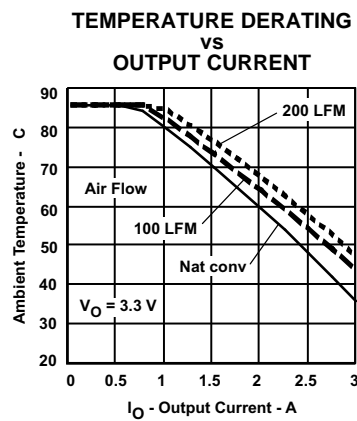

Figure 22.

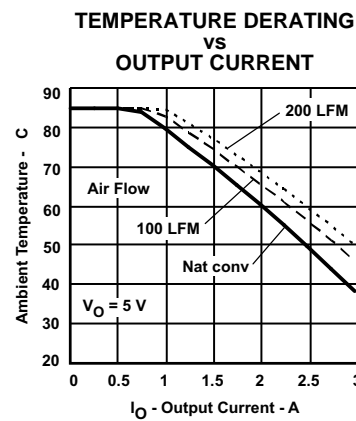

Figure 23.

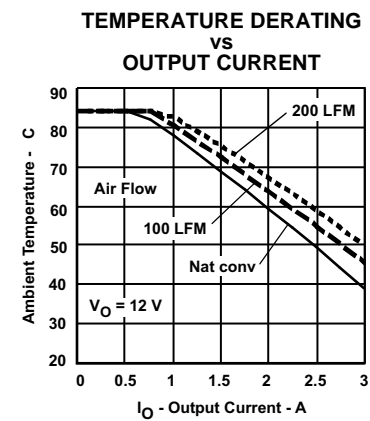

Figure 24.

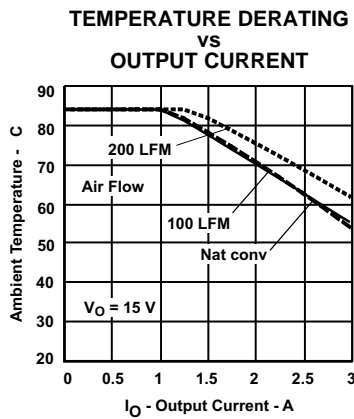

Figure 25.

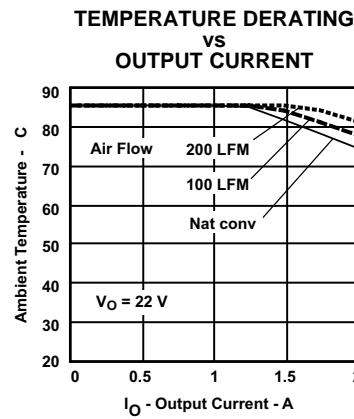

Figure 26.

- (1) The electrical characteristic data has been developed from actual products tested at 25° C. This data is considered typical for the converter. Applies to [Figure 19](#), [Figure 20](#), and [Figure 21](#).
- (2) The temperature derating curves represent the conditions at which internal components are at or below the manufacturer's maximum operating temperatures. Derating limits apply to modules soldered directly to a 100 mm x 100 mm, double-sided PCB with 2 oz. copper. Applies to [Figure 22](#) through [Figure 26](#).

APPLICATION INFORMATION

Adjusting the Output Voltage of the PTN78060 Wide-Output Adjust Power Modules

General

A resistor must be connected between the V_O Adjust control (pin 4) and GND (pin 1) to set the output voltage. The adjustment range is from 2.5 V to 12.6 V for PTN78060W. The adjustment range is from 11.85 V to 22 V for PTN78060H. If pin 4 is left open, the output voltage defaults to the lowest value.

Table 2 gives the standard resistor value for a number of common voltages, and with the actual output voltage that the value produces. For other output voltages, the resistor value can either be calculated using Equation 1 and the constants for the applicable product in Table 1. Alternatively, R_{SET} can be simply selected from the range of values given in Table 3 and Table 4. Figure 27 shows the placement of the required resistor.

$$R_{SET} = 54.9 \text{ k} \frac{1.25 \text{ V}}{V_O - V_{min}} - R_P \quad (1)$$

Table 1. R_{SET} Formula Constants

PRODUCT	V_{MIN}	R_P
PTN780x0W	2.5 V	6.49 k Ω
PTN780x0H	11.824 V	6.65 k Ω

Input Voltage Considerations

The PTN78060 is a step-down switching regulator. In order that the output remains in regulation, the input voltage must exceed the output by a minimum differential voltage.

Another consideration is the pulse width modulation (PWM) range of the regulator's internal control circuit. For stable operation, its operating duty cycle should not be lower than some minimum percentage. This defines the maximum advisable ratio between the regulator input and output voltage magnitudes.

For satisfactory performance, the operating input voltage range of the PTN78060x must adhere to the following requirements.

1. For PTN78060W output voltages lower than 10 V, the minimum input voltage is ($V_O + 2 \text{ V}$) or 7 V, whichever is higher.
2. For PTN78060W output voltages equal to 10 V and higher, the minimum input voltage is ($V_O + 2.5 \text{ V}$).
3. The maximum input voltage for PTN78060W is ($10 \times V_O$) or 36 V, whichever is less.
4. For PTN78060H output voltages lower than 19 V, the minimum input voltage is ($V_O + 3 \text{ V}$) or 15 V, whichever is higher.
5. For PTN78060H output voltages equal to 19 V and higher, the minimum input voltage is ($V_O + 4 \text{ V}$).

As an example, Table 2 gives the operating input voltage range for the common output bus voltages. In addition, the Electrical Characteristics table defines the available output voltage adjust range for various input voltages.

Table 2. Standard Values of R_{set} for Common Output Voltages

PRODUCT	V_O (Required)	R_{SET} (Standard Value)	V_O (Actual)	Operating V_I Range
PTN780x0W	2.5 V	Open	2.5 V	7 V to 25 V
	3.3 V	78.7 k Ω	3.306 V	7 V to 33 V
	5 V	21 k Ω	4.996 V	7 V to 36 V
	12 V	732 Ω	12.002 V	14.5 V to 36 V
PTN780x0H	12 V	383 k Ω	12.000 V	15 V to 36 V
	15 V	15 k Ω	14.994 V	18 V to 36 V
	18 V	4.42 k Ω	18.023 V	21 V to 36 V
	22 V	95.3	21.998 V	26 V to 36 V

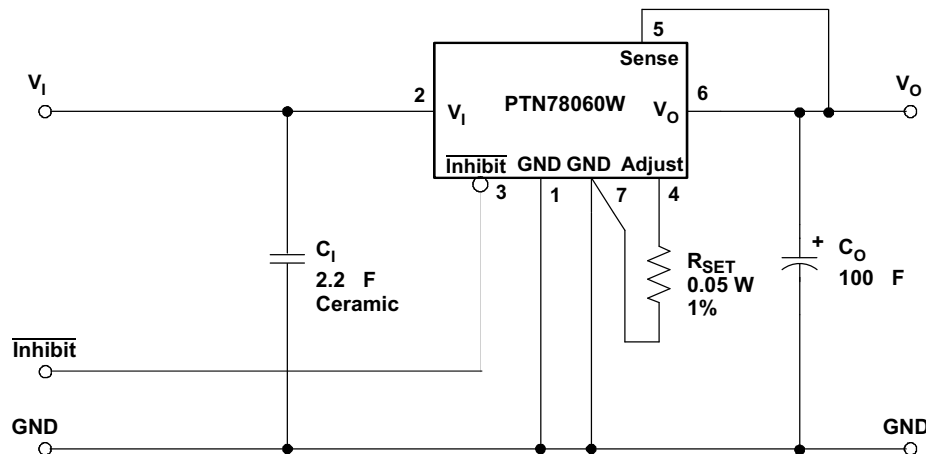

- (1) A 0.05-W rated resistor may be used. The tolerance should be 1%, with a temperature stability of 100 ppm/°C (or better). Place the resistor as close to the regulator as possible. Connect the resistor directly between pins 4 and 7 using dedicated PCB traces.
- (2) Never connect capacitors from V_O Adjust to either GND or V_O . Any capacitance added to the V_O Adjust pin affects the stability of the regulator.

Figure 27. PTN78060W V_O Adjust Resistor Placement

Table 3. PTN78060W Output Voltage Set-Point Resistor Values

V_O	R_{SET}	V_O	R_{SET}	V_O	R_{SET}	V_O	R_{SET}
2.50 V	Open	3.7 V	50.7 k Ω	6.1 V	12.6 k Ω	9.0 V	4.07 k Ω
2.55 V	1.37 M Ω	3.8 V	46.3 k Ω	6.2 V	12.1 k Ω	9.2 V	3.75 k Ω
2.60 V	680 k Ω	3.9 V	42.5 k Ω	6.3 V	11.6 k Ω	9.4 V	3.46 k Ω
2.65 V	451 k Ω	4.0 V	39.3 k Ω	6.4 V	11.1 k Ω	9.6 V	3.18 k Ω
2.70 V	337 k Ω	4.1 V	36.4 k Ω	6.5 V	10.7 k Ω	9.8 V	2.91 k Ω
2.75 V	268 k Ω	4.2 V	33.9 k Ω	6.6 V	10.2 k Ω	10.0 V	2.66 k Ω
2.80 V	222 k Ω	4.3 V	31.6 k Ω	6.7 V	9.85 k Ω	10.2 V	2.42 k Ω
2.85 V	190 k Ω	4.4 V	29.6 k Ω	6.8 V	9.47 k Ω	10.4 V	2.20 k Ω
2.90 V	165 k Ω	4.5 V	27.8 k Ω	6.9 V	9.11 k Ω	10.6 V	1.98 k Ω
2.95 V	146 k Ω	4.6 V	26.2 k Ω	7.0 V	8.76 k Ω	10.8 V	1.78 k Ω
3.00 V	131 k Ω	4.7 V	24.7 k Ω	7.1 V	8.43 k Ω	11.0 V	1.58 k Ω
3.05 V	118 k Ω	4.8 V	23.3 k Ω	7.2 V	8.11 k Ω	11.2 V	1.40 k Ω
3.10 V	108 k Ω	4.9 V	22.1 k Ω	7.3 V	7.81 k Ω	11.4 V	1.22 k Ω
3.15 V	99.1 k Ω	5.0 V	21.0 k Ω	7.4 V	7.52 k Ω	11.6 V	1.05 k Ω
3.20 V	91.5 k Ω	5.1 V	19.9 k Ω	7.5 V	7.24 k Ω	11.8 V	889 Ω
3.25 V	85.0 k Ω	5.2 V	18.9 k Ω	7.6 V	6.97 k Ω	12.0 V	734 Ω
3.30 V	79.3 k Ω	5.3 V	18.0 k Ω	7.7 V	6.71 k Ω	12.2 V	585 Ω
3.35 V	74.2 k Ω	5.4 V	17.2 k Ω	7.8 V	6.46 k Ω	12.4 V	442 Ω
3.40 V	69.8 k Ω	5.5 V	16.4 k Ω	7.9 V	6.22 k Ω	12.6 V	305 Ω
3.45 V	65.7 k Ω	5.6 V	15.6 k Ω	8.0 V	5.99 k Ω		
3.50 V	62.1 k Ω	5.7 V	15.0 k Ω	8.2 V	5.55 k Ω		
3.55 V	58.9 k Ω	5.8 V	14.3 k Ω	8.4 V	5.14 k Ω		
3.60 V	55.9 k Ω	5.9 V	13.7 k Ω	8.6 V	4.76 k Ω		
3.65 V	53.2 k Ω	6.0 V	13.1 k Ω	8.8 V	4.40 k Ω		

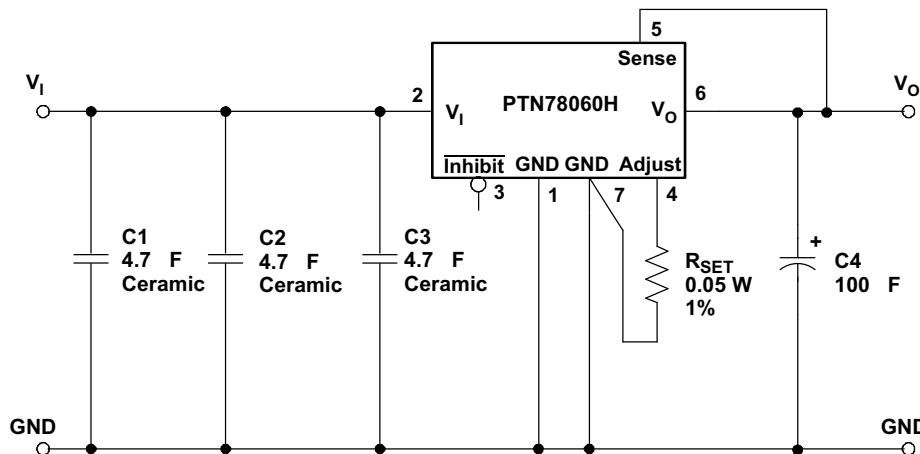

- (1) A 0.05-W rated resistor may be used. The tolerance should be 1%, with a temperature stability of 100 ppm/° C (or better). Place the resistor as close to the regulator as possible. Connect the resistor directly between pins 4 and 7 using dedicated PCB traces.
- (2) Never connect capacitors from V_O Adjust to either GND or V_O . Any capacitance added to the V_O Adjust pin affects the stability of the regulator.

Figure 28. PTN78060H V_O Adjust Resistor Placement

Table 4. PTN78060H Output Voltage Set-Point Resistor Values

V_O	R_{SET}	V_O	R_{SET}	V_O	R_{SET}
11.85 V	2633 k Ω	13.50 V	34.3 k Ω	17.20 V	6.12 k Ω
11.90 V	896 k Ω	13.65 V	30.9 k Ω	17.40 V	5.66 k Ω
11.95 V	538 k Ω	13.80 V	28.1 k Ω	17.60 V	5.23 k Ω
12.00 V	451 k Ω	13.95 V	25.6 k Ω	17.80 V	4.83 k Ω
12.10 V	242 k Ω	14.10 V	23.5 k Ω	18.00 V	4.46 k Ω
12.15 V	204 k Ω	14.25 V	21.6 k Ω	18.20 V	4.11 k Ω
12.20 V	176 k Ω	14.40 V	19.9 k Ω	18.40 V	3.79 k Ω
12.25 V	154 k Ω	14.55 V	18.5 k Ω	18.60 V	3.48 k Ω
12.30 V	138 k Ω	14.70 V	17.2 k Ω	18.80 V	3.19 k Ω
12.35 V	124 k Ω	14.85 V	16.0 k Ω	19.00 V	2.91 k Ω
12.40 V	113 k Ω	15.00 V	14.9 k Ω	19.20 V	2.65 k Ω
12.45 V	103 k Ω	15.15 V	13.9 k Ω	19.40 V	2.41 k Ω
12.50 V	94.9 k Ω	15.30 V	13.1 k Ω	19.60 V	2.18 k Ω
12.55 V	87.9 k Ω	15.45 V	12.3 k Ω	19.80 V	1.95 k Ω
12.60 V	81.8 k Ω	15.60 V	11.5 k Ω	20.00 V	1.74 k Ω
12.65 V	76.4 k Ω	15.75 V	10.8 k Ω	20.20 V	1.54 k Ω
12.70 V	71.7 k Ω	15.90 V	10.2 k Ω	20.40 V	1.35 k Ω
12.75 V	67.5 k Ω	16.05 V	9.59 k Ω	20.60 V	1.17 k Ω
12.80 V	63.7 k Ω	16.20 V	9.03 k Ω	20.80 V	995 Ω
12.85 V	60.2 k Ω	16.35 V	8.51 k Ω	21.00 V	829 k Ω
12.90 V	57.1 k Ω	16.50 V	8.03 k Ω	21.20 V	669 Ω
12.95 V	54.3 k Ω	16.65 V	7.57 k Ω	21.40 V	516 Ω
13.00 V	51.7 k Ω	16.80 V	7.14 k Ω	21.80 V	229 Ω
13.05 V	49.3 k Ω	17.10 V	6.36 k Ω	22.00 V	94 Ω

CAPACITOR RECOMMENDATIONS for the PTN78060 WIDE-OUTPUT ADJUST POWER MODULES

PTN78060W Input Capacitor

PTN78060W has a minimum requirement for input capacitance of 2.2 μF of ceramic capacitance. The dielectric may have either an X5R or X7R temperature characteristic. Ceramic capacitors should be located within 0.5 inch (1,27 cm) of the regulator's input pins. Electrolytic capacitors can be used at the input, but only in addition to the required ceramic capacitance. The minimum ripple current rating for any nonceramic capacitance must be at least 500 mA rms for $V_O \leq 5.5$ V. For $V_O > 5.5$ V, the minimum ripple current rating is 750 mA rms. The ripple current rating of electrolytic capacitors is a major consideration when they are used at the input. This ripple current requirement can be reduced by placing more ceramic capacitors at the input, in addition to the minimum required 2.2 μF .

Tantalum capacitors are not recommended for use at the input bus, as none were found to meet the minimum voltage rating of $2 \times$ (maximum dc voltage + ac ripple). The $2 \times$ rating is standard practice for regular tantalum capacitors to ensure reliability. Polymer-tantalum capacitors are more reliable, and are available with a maximum rating of typically 20 V. These can be used with input voltages up to 16 V.

PTN78060H Input Capacitor

PTN78060H has a minimum requirement for input capacitance of 14.1 μF (3×4.7 μF) of ceramic capacitance. The dielectric may have either an X5R or X7R temperature characteristic. Ceramic capacitors should be located within 0.5 inch (1,27 cm) of the regulator's input pins. Electrolytic capacitors can be used at the input, but only in addition to the required ceramic capacitance. The minimum ripple current rating for any nonceramic capacitance must be at least 400 mA rms. The ripple current rating of electrolytic capacitors is a major consideration when they are used at the input. This ripple current requirement can be reduced by placing more ceramic capacitors at the input, in addition to the minimum required 14.1 μF .

Tantalum capacitors are not recommended for use at the input bus, as none were found to meet the minimum voltage rating of $2 \times$ (maximum dc voltage + ac ripple). The $2 \times$ rating is standard practice for regular tantalum capacitors to ensure reliability. Polymer-tantalum capacitors are more reliable, and are available with a maximum rating of typically 20 V. These can be used with input voltages up to 16 V.

Output Capacitor

The minimum capacitance required to ensure stability is a 100- μF capacitor. Either ceramic or electrolytic-type capacitors can be used. The minimum ripple current rating for the nonceramic capacitance must be at least 150 mA rms. The stability of the module and voltage tolerances are compromised if the capacitor is not placed near the output bus pins. A high-quality, computer-grade electrolytic capacitor should be adequate. A ceramic capacitor can be also be located within 0.5 inch (1,27 cm) of the output pin.

For applications with load transients (sudden changes in load current), the regulator response improves with additional capacitance. Additional electrolytic capacitors should be located close to the load circuit. These capacitors provide decoupling over the frequency range, 2 kHz to 150 kHz. Aluminum electrolytic capacitors are suitable for ambient temperatures above 0° C. For operation below 0° C, tantalum or Os-Con type capacitors are recommended. When using one or more nonceramic capacitors, the calculated equivalent ESR should be no lower than 10 m Ω (17 m Ω using the manufacturer's maximum ESR for a single capacitor). A list of capacitors and vendors are identified in [Table 5](#) and [Table 6](#), the recommended capacitor tables.

Ceramic Capacitors

Above 150 kHz, the performance of aluminum electrolytic capacitors becomes less effective. To further reduce the reflected input ripple current, or improve the output transient response, multilayer ceramic capacitors must be added. Ceramic capacitors have low ESR, and their resonant frequency is higher than the bandwidth of the regulator. When placed at the output, their combined ESR is not critical as long as the total value of ceramic capacitance does not exceed 200 μF .

Tantalum Capacitors

Tantalum-type capacitors may be used at the output, and are recommended for applications where the ambient operating temperature can be less than 0°C. The AVX TPS, Sprague 593D/594/595, and Kemet T495/T510/T520 capacitors series are suggested over many other tantalum types due to their rated surge, power dissipation, and ripple current capability. As a caution, many general-purpose tantalum capacitors have considerably higher ESR, reduced power dissipation, and lower ripple current capability. These capacitors are also less reliable as they have lower power dissipation and surge current ratings. Tantalum capacitors that do not have a stated ESR or surge current rating are not recommended for power applications. When specifying Os-Con and polymer tantalum capacitors for the output, the minimum ESR limit is encountered well before the maximum capacitance value is reached.

Capacitor Table

The capacitor tables, [Table 5](#) and [Table 6](#), identify the characteristics of capacitors from a number of vendors with acceptable ESR and ripple current (rms) ratings. The recommended number of capacitors required at both the input and output buses is identified for each capacitor type. This is not an extensive capacitor list. Capacitors from other vendors are available with comparable specifications. Those listed are for guidance. The rms rating and ESR (at 100 kHz) are critical parameters necessary to ensure both optimum regulator performance and long capacitor life.

Designing for Load Transients

The transient response of the dc/dc converter has been characterized using a load transient with a di/dt of 1 A/μs. The typical voltage deviation for this load transient is given in the data sheet specification table using the required value of output capacitance. As the di/dt of a transient is increased, the response of a converter's regulation circuit ultimately depends on its output capacitor decoupling network. This is an inherent limitation of any dc/dc converter once the speed of the transient exceeds its bandwidth capability. If the target application specifies a higher di/dt or lower voltage deviation, the requirement can only be met with additional output capacitor decoupling. In these cases, special attention must be paid to the type, value, and ESR of the capacitors selected.

If the transient performance requirements exceed those specified in the data sheet, the selection of output capacitors becomes more important. Review the minimum ESR in the characteristic data sheet for details on the capacitance maximum.

Table 5. Recommended Input/Output Capacitors (PTN78060W)

CAPACITOR VENDOR/ COMPONENT SERIES	CAPACITOR CHARACTERISTICS					QUANTITY		VENDOR NUMBER
	WORKING VOLTAGE (V)	VALUE (μF)	EQUIVALENT SERIES RESISTANCE (ESR) (Ω)	85° C MAXIMUM RIPPLE CURRENT (I _{RMS}) (mA)	PHYSICAL SIZE (mm)	INPUT BUS	OUTPUT BUS	
Panasonic FC(Radial)	50	180	0.119	850	10 × 16	1	1	EEUFC1H181
FK (SMD)	50	330	0.12	900	12.50 × 13.5	1 ⁽¹⁾	1	EEVFK1H331Q
United Chemi-Con PXA (SMD)	16	180	0.016	4360	8 × 12	1 ⁽¹⁾	≤1	PXA16VC180MF60 (V _O < 14 V)
LXZ	50	120	0.16	620	10 × 12.5	1 ⁽¹⁾	1	LXZ50VB121M10X12LL (V _I < 32 V)
MVY(SMD)	50	100	0.300	500	10 × 10	1	1	MVY50VC101M10X10TP (V _O ≤ 5.5 V)
Nichicon UWG (SMD)	50	100	0.300	500	10 × 10	1	1	UWG1H101MNR1GS
F550 (Tantalum)	10	100	0.055	2000	7,7 × 4,3	N/R ⁽²⁾	≤ 3 ⁽³⁾	F551A107MN (V _O ≤ 5 V)
HD	50	120	0.072	979	10 × 12,5	1	1	UHD1H151MHR
Sanyo Os-Con SVP (SMD)	20	100	0.024	2500	8 × 12	1 ⁽¹⁾	≤ 2	20SVP100M (V _I ≤ 16 V)
SP	16	100	0.032	2890	10 × 5	1 ⁽¹⁾	≤ 2	16SP100M (V _I ≤ 14 V)

- (1) The voltage rating of the input capacitor must be selected for the desired operating input voltage range of the regulator. To operate the regulator at a higher input voltage, select a capacitor with the next higher voltage rating.
- (2) Not recommended (N/R). The voltage rating does not meet the minimum operating limits in most applications.
- (3) The maximum voltage rating of the capacitor must be selected for the desired set-point voltage (V_O). To operate at a higher output voltage select a capacitor with a higher voltage rating.

Table 5. Recommended Input/Output Capacitors (PTN78060W) (continued)

CAPACITOR VENDOR/ COMPONENT SERIES	CAPACITOR CHARACTERISTICS					QUANTITY		VENDOR NUMBER
	WORKING VOLTAGE (V)	VALUE (μ F)	EQUIVALENT SERIES RESISTANCE (ESR) (Ω)	85° C MAXIMUM RIPPLE CURRENT (I_{RMS}) (mA)	PHYSICAL SIZE (mm)	INPUT BUS	OUTPUT BUS	
AVX Tantalum TPS (SMD)	20	100	0.085	1543	7,3 L \times 4,3 W \times 4,1 H	N/R ⁽²⁾	≤ 3	TPSV107M020R0085 ($V_O \leq 10$ V)
	20	100	0.200	> 817		N/R ⁽²⁾	≤ 3	TPSE107M020R0200 ($V_O \leq 10$ V)
Murata X5R Ceramic	6.3	100	0.002	>1000	3225	N/R ⁽²⁾	≤ 2	GRM32ER60J107M ($V_O \leq 5.5$ V)
TDK X5R Ceramic	6.3	100	0.002	>1000	3225	N/R ⁽²⁾	≤ 2	C3225X5R0J107MT ($V_O \leq 5.5$ V)
Murata X5R Ceramic	16	47	0.002	>1000	3225	1 ⁽¹⁾	≤ 4	GRM32ER61C476M ($V_O \sim V_I \leq 13.5$ V)
Kemet X5R Ceramic	6.3	47	0.002	>1000	3225	N/R ⁽²⁾	≤ 4	C1210C476K9PAC ($V_O \leq 5.5$ V)
TDK X5R Ceramic	6.3	47	0.002	>1000	3225	N/R ⁽²⁾	≤ 4	C3225X5R0J476MT ($V_O \leq 5.5$ V)
Murata X5R Ceramic	6.3	47	0.002	>1000	3225	N/R ⁽²⁾	≤ 4	GRM42-2X5R476M6.3 ($V_O \leq 5.5$ V)
TDK X7R Ceramic	25	2.2	0.002	>1000	3225	≥ 1 ⁽⁴⁾	1	C3225X7R1E225KT/MT ($V_O \leq 20$ V)
Murata X7R Ceramic	25	2.2	0.002	>1000	3225	≥ 1 ⁽⁴⁾	1	GRM32RR71E225K ($V_O \leq 20$ V)
Kemet X7R Ceramic	25	2.2	0.002	>1000	3225	≥ 1 ⁽⁵⁾	1	C1210C225K3RAC ($V_O \leq 20$ V)
AVX X7R Ceramic	25	2.2	0.002	>1000	3225	≥ 1 ⁽⁵⁾	1	C12103C225KAT2A ($V_O \leq 20$ V)
Kemet X7R Ceramic	50	1.0	0.002	>1000	3225	≥ 2 ⁽⁶⁾	1	C1210C105K5RAC
Murata X7R Ceramic	50	4.7	0.002	>1000	3225	≥ 1	1	GRM32ER71H475KA88L
TDK X7R Ceramic	50	2.2	0.002	>1000	3225	≥ 1	1	C3225X7R1H225KT
Murata X7R Ceramic	50	1.0	0.002	>1000	3225	≥ 2 ⁽⁶⁾	1	GRM32RR71H105KA01L
TDK X7R Ceramic	50	1.0	0.002	>1000	3225	≥ 2 ⁽⁶⁾	1	C3225X7R1H105KT
Kemet Radial Through-hole	50	1.0	0.002	>1000	5,08 \times 7,62 \times 9,14 H	≥ 2 ⁽⁶⁾	1	C330C105K5R5CA
Murata Radial Through-hole	50	2.2	0.004	>1000	10 H \times 10 W \times 4 D	≥ 1	1	RPER71H2R2KK6F03

- (4) The maximum rating of the ceramic capacitor limits the regulator's operating input voltage to 20 V. Select an alternative ceramic component to operate at a higher input voltage.
- (5) The maximum rating of the ceramic capacitor limits the regulator's operating input voltage to 20 V. Select an alternative ceramic component to operate at a higher input voltage.
- (6) A total capacitance of 2 μ F is an acceptable replacement value for a single 2.2- μ F ceramic capacitor

Table 6. Recommended Input/Output Capacitors (PTN78060H)

CAPACITOR VENDOR/ COMPONENT SERIES	CAPACITOR CHARACTERISTICS					QUANTITY		VENDOR NUMBER
	WORKING VOLTAGE (V)	VALUE (μ F)	EQUIVALENT SERIES RESISTANCE (ESR) (Ω)	85° C MAXIMUM RIPPLE CURRENT (I _{RMS}) (mA)	PHYSICAL SIZE (mm)	INPUT BUS	OUTPUT BUS	
Panasonic FC(Radial)	50	100	0.162	615	10 × 12.5	1	≥1	EEUFC1H101
FK (SMD)	50	150	0.18	670	10 × 10,2	1 ⁽¹⁾	≥1	EEVFK1H151P
United Chemi-Con PXA (SMD)	16	180	0.016	4360	8 × 12	N/R ⁽²⁾	≤1	PXA16VC180MF60 (V _O < 14 V)
LXZ	50	120	0.160	620	10 × 12,5	1 ⁽¹⁾	≥1	LXZ50VB121M10X12LL
MVY(SMD)	50	100	0.300	500	10 × 10	1	≥1	MVY50VC101M10X10TP
Nichicon UWG (SMD)	50	100	0.300	500	10 × 10	1	≥1	UWG1H101MNR1GS
HD	50	120	0.072	979	10 × 12,5	1	≥1	UHD1H151MHR
Sanyo Os-Con SVP (SMD)	20	100	0.024	2500	8 × 12	1 ⁽¹⁾	≤2	20SVP100M (V _I -V _O ≤ 16 V)
SP	20	120	0.024	3110	8 × 10,5	1 ⁽¹⁾	≤2	20SP120M (V _I -V _O ≤ 16 V)
TDK X7R Ceramic	25	2.2	0.002	>1000	3225	≥ 6 ⁽³⁾	1	C3225X7R1E225KT/MT (V _I -V _O ≤ 20 V)
Murata X7R Ceramic	25	2.2	0.002	>1000	3225	≥ 6 ⁽³⁾	1	GRM32RR71E225K (V _I -V _O ≤ 20 V)
Kemet X7R Ceramic	25	2.2	0.002	>1000	3225	≥ 6 ⁽³⁾	1	C1210C225K3RAC (V _I -V _O ≤ 20 V)
AVX X7R Ceramic	25	2.2	0.002	>1000	3225	≥ 6 ⁽³⁾	1	C12103C225KAT2A (V _I -V _O ≤ 20 V)
Murata X7R Ceramic	50	4.7	0.002	>1000	3225	≥ 3	1	GRM32ER71H475KA88L
TDK X7R Ceramic	50	3.3	0.002	>1000	3225	≥ 4 ⁽⁴⁾	1	CKG45NX7R1H335M
Murata Radial Through-hole	50	3.3	0.003	>1000	12,5 H × 12,5 W × 4	≥ 4 ⁽⁵⁾	1	RPER71H3R3K6F03
Kemet Radial Through-hole	50	4.7	0.003	>1000	5,08 × 7,62 × 9,14	≥ 3	1	C350C475K5R5CA

- (1) The voltage rating of the input capacitor must be selected for the desired operating input voltage range of the regulator. To operate the regulator at a higher input voltage, select a capacitor with the next higher voltage rating.
- (2) Not recommended (N/R). The voltage rating does not meet the minimum operating limits in most applications.
- (3) The maximum rating of the ceramic capacitor limits the regulator's operating input voltage to 20 V. Select an alternative ceramic component to operate at a higher input voltage.
- (4) A total capacitance of 13.2 μ F is an acceptable replacement value for 3 × 4.7 μ F ceramic capacitors
- (5) A total capacitance of 2 μ F is an acceptable replacement value for a single 2.2- μ F ceramic capacitor

Power-Up Characteristics

When configured per the standard application, the PTN78060 power module produces a regulated output voltage following the application of a valid input source voltage. During power up, internal soft-start circuitry slows the rate that the output voltage rises, thereby limiting the amount of in-rush current that can be drawn from the input source. The soft-start circuitry introduces a short time delay (typically 5 ms – 10 ms) into the power-up characteristic. This is from the point that a valid input source is recognized. [Figure 29](#) shows the power-up waveforms when operating from a 12-V input and with the output voltage adjusted to 5 V. The waveforms were measured with a 2.8-A resistive load.

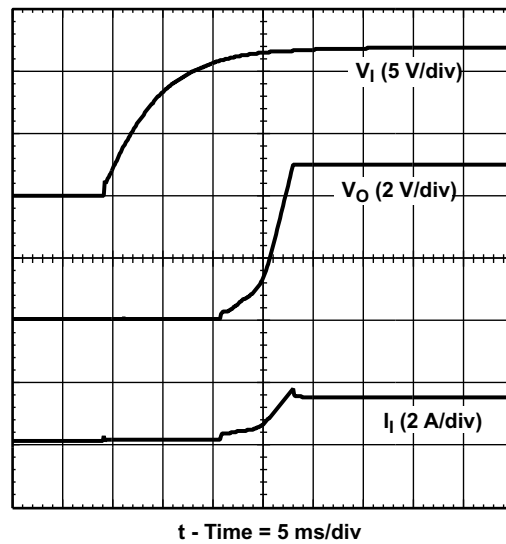

Figure 29. Power-Up Waveforms

Undervoltage Lockout

The undervoltage lockout (UVLO) circuit prevents the module from attempting to power up until the input voltage is above the UVLO threshold. This is to prevent the module from drawing excessive current from the input source at power up. Below the UVLO threshold, the module is held off.

Current Limit Protection

The module is protected against load faults with a continuous current limit characteristic. Under a load-fault condition, the output current increases to the current limit threshold. Attempting to draw current that exceeds the current limit threshold causes the module to progressively reduce its output voltage. Current is continuously supplied to the fault until the fault is removed. Once it is removed, the output voltage promptly recovers. When limiting output current, the regulator experiences higher power dissipation, which increases its temperature. If the temperature increase is excessive, the module overtemperature protection begins to periodically turn the output voltage off.

Overtemperature Protection

A thermal shutdown mechanism protects the module's internal circuitry against excessively high temperatures. A rise in temperature may be the result of a drop in airflow, a high ambient temperature, or a sustained current limit condition. If the internal temperature rises excessively, the module turns itself off, reducing the output voltage to zero. The module exercises a soft-start power up when the sensed temperature has decreased by about 10° C below the trip point.

NOTE: Overtemperature protection is a last resort mechanism to prevent damage to the module. It should not be relied on as permanent protection against thermal stress. Always operate the module within its temperature derated limits, for the worst-case operating conditions of output current, ambient temperature, and airflow. Operating the module above these limits, albeit below the thermal shutdown temperature, reduces the long-term reliability of the module.

Output Voltage Sense

An external voltage sense improves the load regulation performance of the module by enabling it to compensate for any IR-voltage drop between the module and the load circuit. This voltage drop is caused by the flow of current through the resistance in the printed-circuit board connections.

To use the output voltage sense feature, simply connect the V_O Sense input (pin 5) to V_O , close to the device that draws the most supply current. If an external voltage sense is not desired, the V_O Sense input may be left open circuit. An internal resistor (15 Ω or less), connected between this input and V_O , ensures that the output remains in regulation.

With V_O Sense connected, the difference between the voltage measure directly between the V_O and GND , and that measured from V_O Sense to GND , represents the amount of IR-voltage drop being compensated by the regulator. This should be limited to a maximum of 0.3 V.

Note: The external voltage sense is not designed to compensate for the forward drop of nonlinear or frequency-dependent components that may be placed in series with the regulator's output. Examples include OR-ing diodes, filter inductors, ferrite beads, and fuses. When these components are enclosed by the external sense connection, they are effectively placed inside the regulation control loop. This can adversely affect the stability of the module.

Output On/Off Inhibit

The inhibit feature can be used wherever there is a requirement for the output voltage to be turned off. The power module functions normally when the Inhibit control (pin 3) is left open-circuit, providing a regulated output whenever a valid source voltage is connected to V_I with respect to GND . Figure 30 shows the the circuit used to demonstrate the inhibit function. Note the discrete transistor (Q1). Turning Q1 on applies a low voltage to the *Inhibit* control pin and turns the module off. The output voltage decays as the load circuit discharges the capacitance. The current drawn at the input is reduced to typically 17 mA. If Q1 is then turned off, the module executes a soft-start power up. A regulated output voltage is produced within 20 ms. Figure 31 shows the typical rise in the output voltage, following the turn off of Q1. The turn off of Q1 corresponds to the fall in the waveform, Q1 V_{gs} . The waveforms were measured with a 2.8-A resistive load.

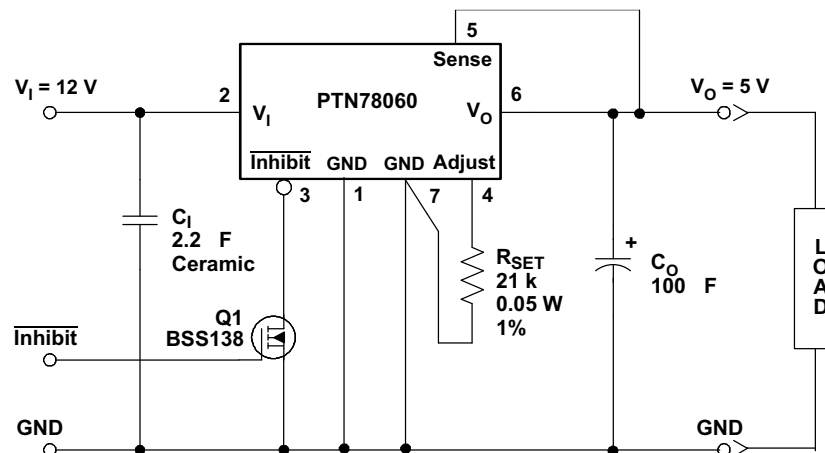

Figure 30. On/Off Inhibit Control Circuit

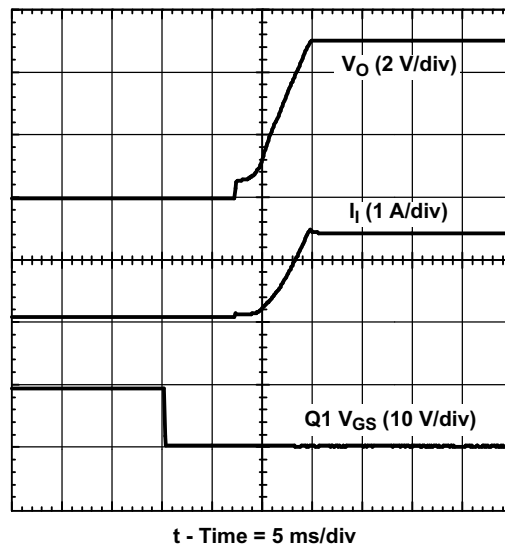

Figure 31. Power-Up Response From Inhibit Control

Optional Input/Output Filters

Power modules include internal input and output ceramic capacitors in all of their designs. However, some applications require much lower levels of either input reflected or output ripple/noise. This application describes various filters and design techniques found to be successful in reducing both input and output ripple/noise.

Input/Output Capacitors

The easiest way to reduce output ripple and noise is to add one or more 1- μ F ceramic capacitors, such as C4 shown in Figure 32. Ceramic capacitors should be placed close to the output power terminals. A single 1- μ F capacitor reduces the output ripple/noise by 10% to 30% for modules with a rated output current of less than 3 A. (Note: C3 is recommended to improve the regulators transient response, and does not reduce output ripple and noise.)

Switching regulators draw current from the input line in pulses at their operating frequency. The amount of reflected (input) ripple/noise generated is directly proportional to the equivalent source impedance of the power source including the impedance of any input lines. The addition of C1, minimum 1- μ F ceramic capacitor, near the input power pins, reduces reflected conducted ripple/noise by up to 20%.

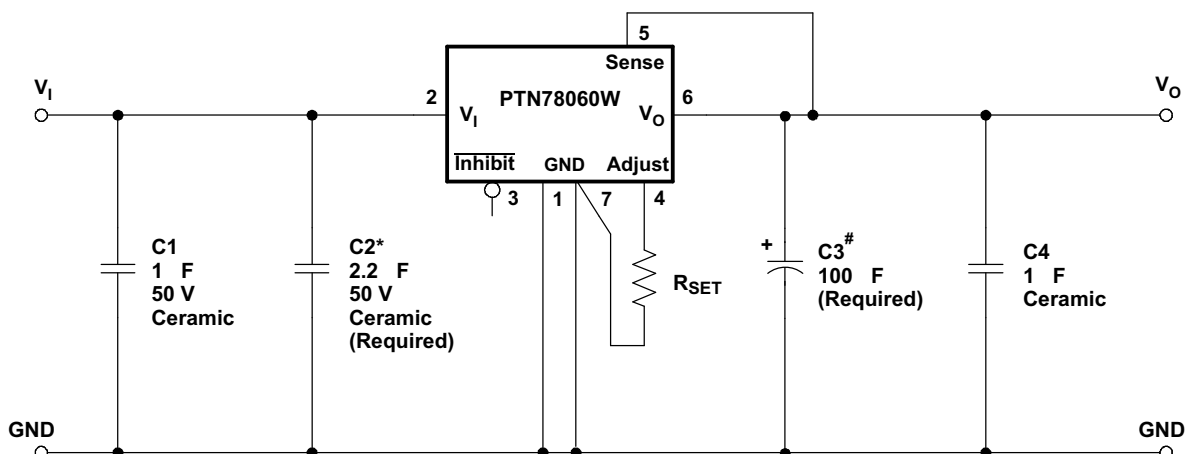

* See specifications for required value and type. For PTN78060H, C2 is equal to 3 x 4.7 F.

See Application Information section for suggested value and type.

Figure 32. Adding High-Frequency Bypass Capacitors To The Input and Output

π Filters

If a further reduction in ripple/noise level is required for an application, higher order filters must be used. A π (pi) filter, employing a ferrite bead (Fair-Rite part number 2673000701 or equivalent) in series with the input or output terminals of the regulator reduces the ripple/noise by at least 20 db (see Figure 33 and Figure 34). In order for the inductor to be effective ceramic capacitors are also required. (Note: see Capacitor Recommendations for additional information on vendors and component suggestions.)

These inductors plus ceramic capacitors form an excellent filter because of the rejection at the switching frequency (650 kHz - 1 MHz). The placement of this filter is critical. It must be located as close as possible to the input or output pins to be effective. The ferrite bead is small (12,5 mm × 3 mm), easy to use, low cost, and has low dc resistance. Fair-Rite also manufactures a surface-mount bead (part number 2773021447). It is rated to 5 A, and can be used on the output bus. As an alternative, suitably rated 1-μH to 5-μH wound inductors can be used in place of the ferrite inductor bead.

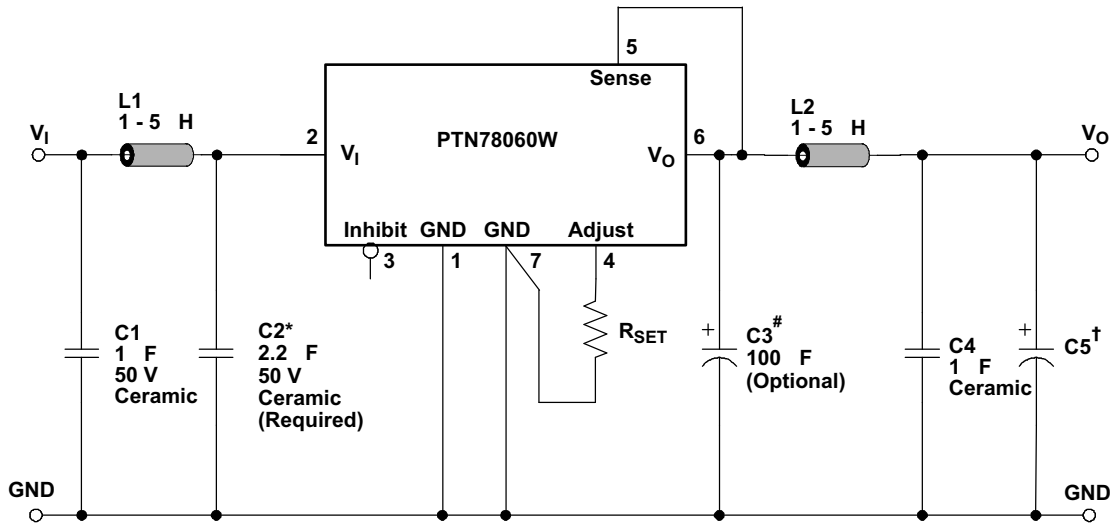

* See specifications for required value and type. For PTN78060H, C2 is equal to 3 x 4.7 F.
 # See *Application Information* section for suggested value and type.
 † Recommended whenever I_O is greater than 2 A.

Figure 33. Adding π Filters (I_O ≤ 3 A)

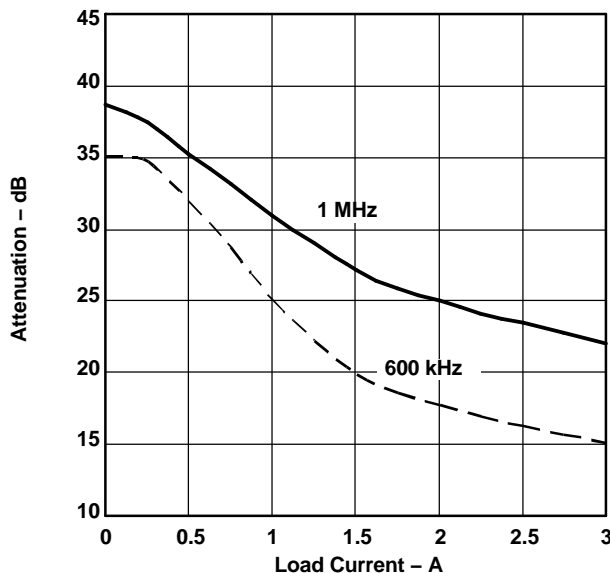

Figure 34. π-Filter Attenuation vs. Load Current

PACKAGING INFORMATION

Orderable Device	Status ⁽¹⁾	Package Type	Package Drawing	Pins	Package Qty	Eco Plan ⁽²⁾	Lead/Ball Finish	MSL Peak Temp ⁽³⁾
PTN78060HAH	ACTIVE	DIP MOD ULE	EUW	7	36	Pb-Free (RoHS)	Call TI	N / A for Pkg Type
PTN78060HAS	ACTIVE	DIP MOD ULE	EUY	7	36	TBD	Call TI	Level-1-235C-UNLIM/ Level-3-260C-168HRS
PTN78060HAST	ACTIVE	DIP MOD ULE	EUY	7	250	TBD	Call TI	Level-1-235C-UNLIM/ Level-3-260C-168HRS
PTN78060HAZ	ACTIVE	DIP MOD ULE	EUY	7	36	Pb-Free (RoHS)	Call TI	Level-3-260C-168 HR
PTN78060HAZT	ACTIVE	DIP MOD ULE	EUY	7	250	Pb-Free (RoHS)	Call TI	Level-3-260C-168 HR
PTN78060WAD	ACTIVE	DIP MOD ULE	EUW	7	36	Pb-Free (RoHS)	Call TI	N / A for Pkg Type
PTN78060WAH	ACTIVE	DIP MOD ULE	EUW	7	36	Pb-Free (RoHS)	Call TI	N / A for Pkg Type
PTN78060WAS	ACTIVE	DIP MOD ULE	EUY	7	36	TBD	Call TI	Level-1-235C-UNLIM/ Level-3-260C-168HRS
PTN78060WAST	ACTIVE	DIP MOD ULE	EUY	7	250	TBD	Call TI	Level-1-235C-UNLIM/ Level-3-260C-168HRS
PTN78060WAZ	ACTIVE	DIP MOD ULE	EUY	7	36	Pb-Free (RoHS)	Call TI	Level-3-260C-168 HR
PTN78060WAZT	ACTIVE	DIP MOD ULE	EUY	7	250	Pb-Free (RoHS)	Call TI	Level-3-260C-168 HR

⁽¹⁾ The marketing status values are defined as follows:

ACTIVE: Product device recommended for new designs.

LIFEBUY: TI has announced that the device will be discontinued, and a lifetime-buy period is in effect.

NRND: Not recommended for new designs. Device is in production to support existing customers, but TI does not recommend using this part in a new design.

PREVIEW: Device has been announced but is not in production. Samples may or may not be available.

OBSOLETE: TI has discontinued the production of the device.

⁽²⁾ Eco Plan - The planned eco-friendly classification: Pb-Free (RoHS), Pb-Free (RoHS Exempt), or Green (RoHS & no Sb/Br) - please check <http://www.ti.com/productcontent> for the latest availability information and additional product content details.

TBD: The Pb-Free/Green conversion plan has not been defined.

Pb-Free (RoHS): TI's terms "Lead-Free" or "Pb-Free" mean semiconductor products that are compatible with the current RoHS requirements for all 6 substances, including the requirement that lead not exceed 0.1% by weight in homogeneous materials. Where designed to be soldered at high temperatures, TI Pb-Free products are suitable for use in specified lead-free processes.

Pb-Free (RoHS Exempt): This component has a RoHS exemption for either 1) lead-based flip-chip solder bumps used between the die and package, or 2) lead-based die adhesive used between the die and leadframe. The component is otherwise considered Pb-Free (RoHS compatible) as defined above.

Green (RoHS & no Sb/Br): TI defines "Green" to mean Pb-Free (RoHS compatible), and free of Bromine (Br) and Antimony (Sb) based flame retardants (Br or Sb do not exceed 0.1% by weight in homogeneous material)

⁽³⁾ MSL, Peak Temp. -- The Moisture Sensitivity Level rating according to the JEDEC industry standard classifications, and peak solder temperature.

Important Information and Disclaimer:The information provided on this page represents TI's knowledge and belief as of the date that it is provided. TI bases its knowledge and belief on information provided by third parties, and makes no representation or warranty as to the accuracy of such information. Efforts are underway to better integrate information from third parties. TI has taken and continues to take reasonable steps to provide representative and accurate information but may not have conducted destructive testing or chemical analysis on incoming materials and chemicals. TI and TI suppliers consider certain information to be proprietary, and thus CAS numbers and other limited information may not be available for release.

In no event shall TI's liability arising out of such information exceed the total purchase price of the TI part(s) at issue in this document sold by TI

to Customer on an annual basis.

EUY (R-PDSS-B7)

DOUBLE SIDED MODULE

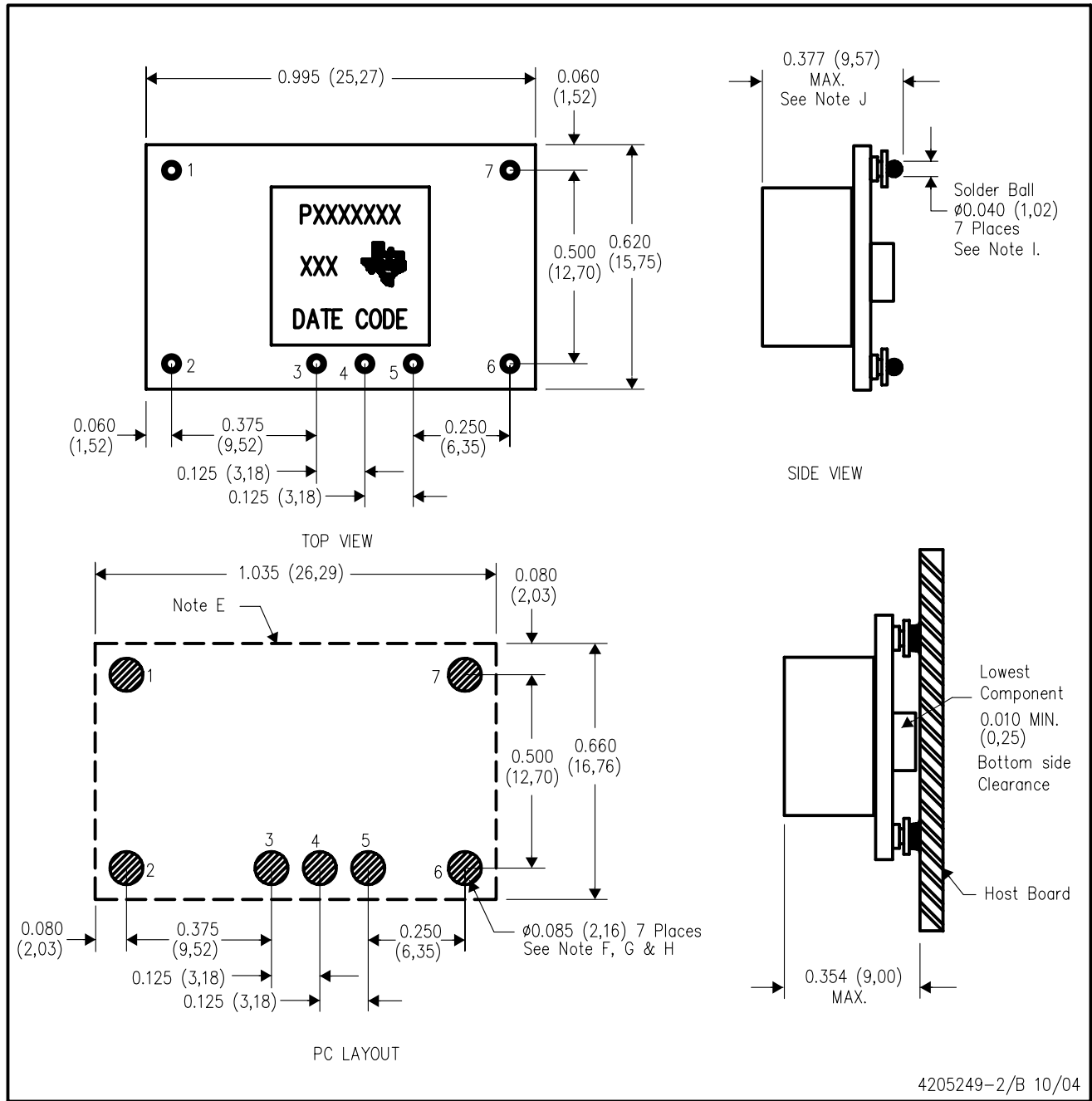

- NOTES:
- A. All linear dimensions are in inches (mm).
 - B. This drawing is subject to change without notice.
 - C. 2 place decimals are ± 0.030 ($\pm 0,76$ mm).
 - D. 3 place decimals are ± 0.010 ($\pm 0,25$ mm).
 - E. Recommended keep out area for user components.
 - F. Power pin connection should utilize two or more vias to the interior power plane of 0.025 (0,63) I.D. per input, ground and output pin (or the electrical equivalent).

- G. Paste screen opening: 0.080 (2,03) to 0.085 (2,16).
Paste screen thickness: 0.006 (0,15).
- H. Pad type: Solder mask defined.
- I. All pins: Material – Copper Alloy
Finish – Tin (100%) over Nickel plate
Solder Ball – See product data sheet.
- J. Dimension prior to reflow solder.

EUW (R-PDSS-T7)

DOUBLE SIDED MODULE

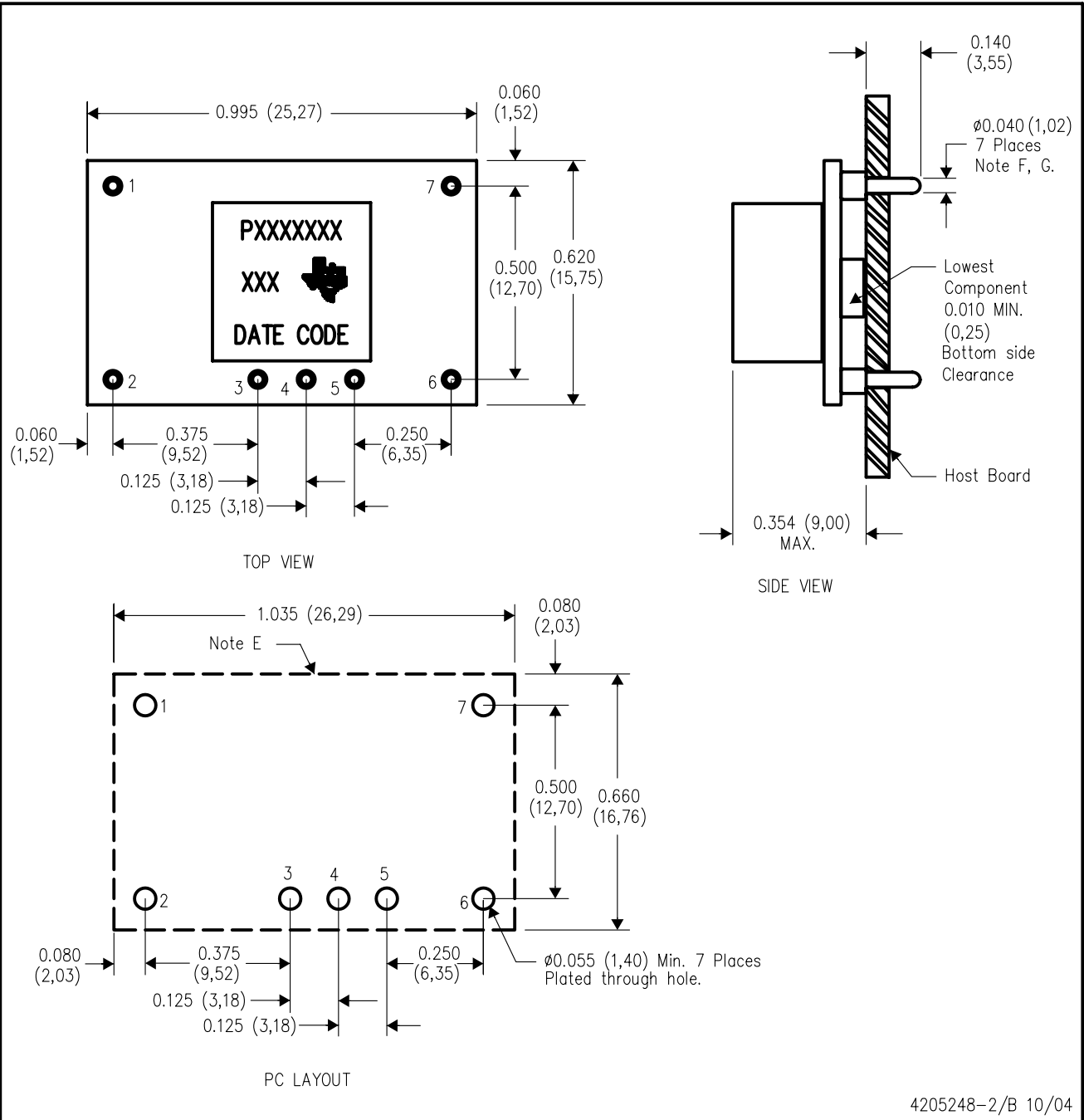

4205248-2/B 10/04

- NOTES:
- A. All linear dimensions are in inches (mm).
 - B. This drawing is subject to change without notice.
 - C. 2 place decimals are ± 0.030 ($\pm 0,76$ mm).
 - D. 3 place decimals are ± 0.010 ($\pm 0,25$ mm).
 - E. Recommended keep out area for user components

- F. Pins are 0.040" (1,02) diameter with 0.070" (1,78) diameter standoff shoulder.
- G. All pins: Material - Copper Alloy
Finish - Tin (100%) over Nickel plate

IMPORTANT NOTICE

Texas Instruments Incorporated and its subsidiaries (TI) reserve the right to make corrections, modifications, enhancements, improvements, and other changes to its products and services at any time and to discontinue any product or service without notice. Customers should obtain the latest relevant information before placing orders and should verify that such information is current and complete. All products are sold subject to TI's terms and conditions of sale supplied at the time of order acknowledgment.

TI warrants performance of its hardware products to the specifications applicable at the time of sale in accordance with TI's standard warranty. Testing and other quality control techniques are used to the extent TI deems necessary to support this warranty. Except where mandated by government requirements, testing of all parameters of each product is not necessarily performed.

TI assumes no liability for applications assistance or customer product design. Customers are responsible for their products and applications using TI components. To minimize the risks associated with customer products and applications, customers should provide adequate design and operating safeguards.

TI does not warrant or represent that any license, either express or implied, is granted under any TI patent right, copyright, mask work right, or other TI intellectual property right relating to any combination, machine, or process in which TI products or services are used. Information published by TI regarding third-party products or services does not constitute a license from TI to use such products or services or a warranty or endorsement thereof. Use of such information may require a license from a third party under the patents or other intellectual property of the third party, or a license from TI under the patents or other intellectual property of TI.

Reproduction of TI information in TI data books or data sheets is permissible only if reproduction is without alteration and is accompanied by all associated warranties, conditions, limitations, and notices. Reproduction of this information with alteration is an unfair and deceptive business practice. TI is not responsible or liable for such altered documentation. Information of third parties may be subject to additional restrictions.

Resale of TI products or services with statements different from or beyond the parameters stated by TI for that product or service voids all express and any implied warranties for the associated TI product or service and is an unfair and deceptive business practice. TI is not responsible or liable for any such statements.

TI products are not authorized for use in safety-critical applications (such as life support) where a failure of the TI product would reasonably be expected to cause severe personal injury or death, unless officers of the parties have executed an agreement specifically governing such use. Buyers represent that they have all necessary expertise in the safety and regulatory ramifications of their applications, and acknowledge and agree that they are solely responsible for all legal, regulatory and safety-related requirements concerning their products and any use of TI products in such safety-critical applications, notwithstanding any applications-related information or support that may be provided by TI. Further, Buyers must fully indemnify TI and its representatives against any damages arising out of the use of TI products in such safety-critical applications.

TI products are neither designed nor intended for use in military/aerospace applications or environments unless the TI products are specifically designated by TI as military-grade or "enhanced plastic." Only products designated by TI as military-grade meet military specifications. Buyers acknowledge and agree that any such use of TI products which TI has not designated as military-grade is solely at the Buyer's risk, and that they are solely responsible for compliance with all legal and regulatory requirements in connection with such use.

TI products are neither designed nor intended for use in automotive applications or environments unless the specific TI products are designated by TI as compliant with ISO/TS 16949 requirements. Buyers acknowledge and agree that, if they use any non-designated products in automotive applications, TI will not be responsible for any failure to meet such requirements.

Following are URLs where you can obtain information on other Texas Instruments products and application solutions:

Products

Amplifiers	amplifier.ti.com
Data Converters	dataconverter.ti.com
DSP	dsp.ti.com
Clocks and Timers	www.ti.com/clocks
Interface	interface.ti.com
Logic	logic.ti.com
Power Mgmt	power.ti.com
Microcontrollers	microcontroller.ti.com
RFID	www.ti-rfid.com
RF/IF and ZigBee® Solutions	www.ti.com/lprf

Applications

Audio	www.ti.com/audio
Automotive	www.ti.com/automotive
Broadband	www.ti.com/broadband
Digital Control	www.ti.com/digitalcontrol
Medical	www.ti.com/medical
Military	www.ti.com/military
Optical Networking	www.ti.com/opticalnetwork
Security	www.ti.com/security
Telephony	www.ti.com/telephony
Video & Imaging	www.ti.com/video
Wireless	www.ti.com/wireless

Mailing Address: Texas Instruments, Post Office Box 655303, Dallas, Texas 75265
Copyright © 2008, Texas Instruments Incorporated