

## 10-W, 36-V to 75-V INPUT, 1500-V ISOLATION, DC/DC CONVERTERS

### FEATURES

- Input Voltage: 36 V to 75 V
- 10-W Total Output Power
- Output Voltages: 3.3 V, 5 V, and 12 V
- Output Voltage Trim  $\pm 10\%$
- Up To 87% Efficiency
- Overcurrent Protection
- Input Undervoltage Lockout
- Output Overvoltage Protection
- Positive or Negative Logic Enable Control Option
- Synchronization Option
- Space-Saving, Industry Standard Footprint (1.1 in x 1.0 in) / (27.94 mm x 24.38 mm)
- Industry Standard Pinout
- Surface Mount Package
- 1500-Vdc Isolation
- Agency Approvals:  
UL/IEC/CSA-C22.2 60950-1

### APPLICATIONS

- Intermediate Bus Architectures
- Telecom, High-End Computing Platforms
- Power Over Ethernet Applications
- Multi-Rail Power Systems

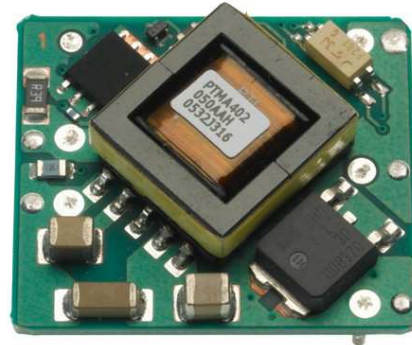

### DESCRIPTION

The PTMA40XX is a series of 10-W rated isolated dc/dc converters, designed to operate from a standard -48-V telecom central office supply. Housed in an industry standard 1.1 in x 1.0 in (27.94 mm x 24.38 mm) package, this series of isolated modules is set to one of the common intermediate bus voltages of 3.3 V, 5 V, or 12 V.

The PTMA40XX series includes many features expected of high-performance dc/dc converter modules. Operational features include an input undervoltage lockout (UVLO) and a dual-logic output enable control or synchronization option. Overcurrent protection ensures survival against load faults.

Typical applications include distributed power architectures in both telecom and computing environments, power over ethernet, and particularly complex digital systems requiring multiple power supply rails.

### TYPICAL APPLICATION

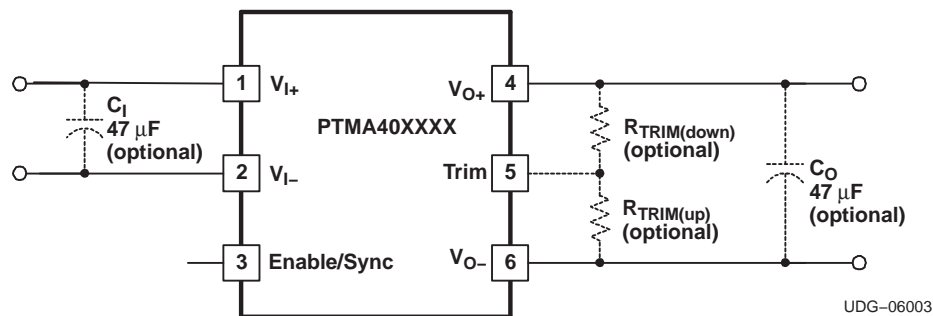

Please be aware that an important notice concerning availability, standard warranty, and use in critical applications of Texas Instruments semiconductor products and disclaimers thereto appears at the end of this data sheet.



These devices have limited built-in ESD protection. The leads should be shorted together or the device placed in conductive foam during storage or handling to prevent electrostatic damage to the MOS gates.

### ORDERING INFORMATION

For the most current package and ordering information, see the Package Option Addendum at the end of this datasheet, or see the TI website at [www.ti.com](http://www.ti.com).

### PART NUMBERING SCHEME

	Input Voltage	Output Current	Output Voltage	Enable	Electrical Options		Pin Style	Shipping Package
<b>PTMA</b>	<b>4</b>	<b>02</b>	<b>050</b>	<b>P</b>	<b>2</b>	<b>A</b>	<b>D</b>	<b>T</b>
	4 = 48 V	01 = 1 A 02 = 2 A 03 = 3 A	033 = 3.3 V 050 = 5.0 V 120 = 12.0 V	A = None N = Negative P = Positive	1 = None 2 = $V_O$ Adjust 3 = $V_O$ Adjust & Synchronization		D = Through-hole, Pb-free S = SMD, SnPb solder ball Z = SMD, SnAgCu solder ball	Blank = Tray T = Tape and Reel

### ABSOLUTE MAXIMUM RATINGS

			UNIT
$V_I$	Input Voltage	Continuous	75 V
		Surge, 1 s max	100 V <sup>(1)</sup>
$T_A$	Operating temperature range	Over $V_I$ range	-40°C to 85°C
$T_{WAVE}$	Wave solder temperature	Surface temperature of module or pins <b>(20 seconds)</b>	AD suffix 260°C <sup>(2)</sup>
$T_{REFLOW}$	Solder reflow temperature	Surface temperature of module or pins <b>(20 seconds)</b>	AS suffix 235°C <sup>(2)</sup>
			AZ suffix 260°C <sup>(2)</sup>
$T_{STG}$	Storage temperature		-55°C to 125°C
$P_O$	Output Power		10 W

- (1) The converter's internal protection circuitry may cause the output to turn off when the applied input voltage is greater than 75 V.  
(2) During solder reflow of SMD package version, do not elevate the module PCB, pins, or internal component temperatures beyond this peak temperature.

### PACKAGE SPECIFICATIONS

			UNITS
Weight			6.5 grams
Flammability	Meets UL94V-O		
Mechanical shock	Per Mil-STD-883D, Method 2002.3, 1 ms, 1/2 Sine, mounted	Horizontal T/H (Suffix AD)	500 G <sup>(1)</sup>
		Horizontal SMD (Suffix AS & AZ)	500 G <sup>(1)</sup>
Mechanical vibration	Mil-STD-883D, Method 2007.2, 20-2000 Hz, PCB mounted	Horizontal T/H (Suffix AD)	20 G <sup>(1)</sup>
		Horizontal SMD (Suffix AS & AZ)	10 G <sup>(1)</sup>
Reliability	Telcordia SR-332 50% stress, $T_A = 40^\circ\text{C}$ , ground benign	MTBF	7.3 10 <sup>6</sup> Hr

- (1) Qualification limit.

**PTMA403033 ELECTRICAL CHARACTERISTICS**
 $T_A = 25^\circ\text{C}$ ,  $V_I = 48\text{ V}$ ,  $V_O = 3.3\text{ V}$ ,  $C_I = 0\ \mu\text{F}$ ,  $C_O = 0\ \mu\text{F}$ , and  $I_O = I_{O\text{max}}$  (Unless otherwise stated)

PARAMETER		TEST CONDITIONS	PTMA403033			UNIT
			MIN	TYP	MAX	
$P_O$	Output power	Over $V_I$ range			10	W
$I_O$	Output current	Over $V_I$ range	0.1 <sup>(1)</sup>		3 <sup>(2)</sup>	A
$I_{LIM}$	Current Limit Threshold	Shutdown, followed by autorecovery		4.25		A
$V_I$	Input voltage range	Over $I_O$ range	36	48	75	V
$V_O$	Set-point voltage tolerance			$\pm 2$ <sup>(3)</sup>		% $V_O$
	Temperature variation	$-40^\circ\text{C} \leq T_A \leq 85^\circ\text{C}$		$\pm 1$		% $V_O$
	Line regulation	Over $V_I$ range		$\pm 3$		mV
	Load regulation	Over $I_O$ range		$\pm 10$		mV
	Total output voltage variation	Includes set-point, line, load, $-40^\circ\text{C} \leq T_A \leq 85^\circ\text{C}$		3	5 <sup>(3)</sup>	% $V_O$
	Trim adjust range	Over $V_I$ range		3.0		3.6
$\eta$	Efficiency	$P_O = P_{O\text{max}}$		82%		
	$V_O$ Ripple (peak-to-peak)	20-MHz bandwidth		65		mV <sub>pp</sub>
	Transient response	0.1 A/ $\mu\text{s}$ load step, 50% to 100% $I_{O\text{max}}$	Recovery time		750	$\mu\text{s}$
			$V_O$ over/undershoot		$\pm 150$	mV
	Output enable input (pin 3)	Referenced to $V_{I-}$	Input high voltage ( $V_{IH}$ )	4.5	Open <sup>(4)</sup>	V
			Input low voltage ( $V_{IL}$ )	-0.2	0.8	
			Input low current ( $I_{IL}$ )		1	mA
	Standby input current	Pin 3 open		8		mA
UVLO	Undervoltage lockout		32		34	V
OVP	Output Overvoltage Protection		3.7		5.4	V
$f_S$	Switching frequency	Over $V_I$ and $I_O$ ranges (non-Sync option)	250	300	350	kHz
SYNC	Sync switching frequency	Free-running	180	215 <sup>(5)</sup>	250	kHz
		Synchronization range	250 <sup>(5)</sup>		350 <sup>(5)</sup>	
	high-level input voltage		3.5		6	V
	low-level input voltage		-0.3		0.5	V
	clock duty cycle		25		75	%
$C_I$	External input capacitance		0	47		$\mu\text{F}$
$C_O$	External output capacitance		0	47 <sup>(6)</sup>	1000	$\mu\text{F}$
$V_{ISO}$	Isolation voltage	Primary-Secondary	1,500			Vdc
$C_{ISO}$	Isolation capacitance		1,100			pF
$R_{ISO}$	Isolation resistance		10			M $\Omega$

- (1) The converter requires a minimum load current for proper operation. However, the converter is not damaged when operated under a no-load condition.
- (2) See temperature derating curves for safe operating area (SOA), to determine output current derating at elevated ambient temperatures.
- (3) The set-point voltage tolerance is affected by the tolerance and stability of  $R_{TRIM}$ . The stated limit is unconditionally met if  $R_{TRIM}$  has a tolerance of  $\leq 1\%$ , with  $\leq 100\text{ ppm}/^\circ\text{C}$  temperature stability.
- (4) The Enable input (pin 3) has an internal pullup resistor. Do not place an external pullup resistor on this input pin. If the enable feature is not used, for a positive enable device this input should be left open circuit and a negative enable device should be permanently connected to  $V_{I-}$  (pin 2). A discrete MOSFET or bipolar transistor is recommended for the enable control. The open-circuit voltage is typically less than 5 V. See the *Application Information* for a more detailed description.
- (5) A device with the synchronization option has a reduced switching frequency of 215 kHz typical. The synchronization frequency can only be adjusted to a higher frequency, up to 350 kHz maximum.
- (6) An output capacitor is not required for proper operation. However, additional capacitance at the load improves the transient response.

## PTMA402050 ELECTRICAL CHARACTERISTICS

$T_A = 25^\circ\text{C}$ ,  $V_I = 48\text{ V}$ ,  $V_O = 5\text{ V}$ ,  $C_I = 0\ \mu\text{F}$ ,  $C_O = 0\ \mu\text{F}$ , and  $I_O = I_{O\text{max}}$  (Unless otherwise stated)

PARAMETER		TEST CONDITIONS	PTMA402050			UNIT
			MIN	TYP	MAX	
$P_O$	Output power	Over $V_I$ range			10	W
$I_O$	Output current	Over $V_I$ range	0.1 <sup>(1)</sup>		2 <sup>(2)</sup>	A
$I_{LIM}$	Current Limit Threshold	Shutdown, followed by autorecovery		3		A
$V_I$	Input voltage range	Over $I_O$ range	36	48	75	V
$V_O$	Set-point voltage tolerance			$\pm 2$ <sup>(3)</sup>		$\%V_O$
	Temperature variation	$-40^\circ\text{C} \leq T_A \leq 85^\circ\text{C}$		$\pm 1$		$\%V_O$
	Line regulation	Over $V_I$ range		5		mV
	Load regulation	Over $I_O$ range		10		mV
	Total output voltage variation	Includes set-point, line, load, $-40^\circ\text{C} \leq T_A \leq 85^\circ\text{C}$		3	5 <sup>(3)</sup>	$\%V_O$
	Trim adjust range	Over $V_I$ range		4.5		5.5
$\eta$	Efficiency	$P_O = P_{O\text{max}}$		85%		
	$V_O$ Ripple (peak-to-peak)	20-MHz bandwidth		55		$\text{mV}_{pp}$
	Transient response	0.1 A/ $\mu\text{s}$ load step, 50% to 100% $I_{O\text{max}}$	Recovery time		250	$\mu\text{s}$
			$V_O$ over/undershoot		$\pm 150$	mV
Output enable input (pin 3)	Referenced to $V_{I-}$	Input high voltage ( $V_{IH}$ )	4.5		Open <sup>(4)</sup>	V
		Input low voltage ( $V_{IL}$ )	-0.2		0.8	
		Input low current ( $I_{IL}$ )		1		
	Standby input current	Pin 3 open		8		mA
UVLO	Undervoltage lockout		32		34	V
OVP	Output Overvoltage Protection		5.6		7.9	V
$f_S$	Switching frequency	Over $V_I$ range	250	300	350	kHz
SYNC	Sync switching frequency	Free-running	180	215 <sup>(5)</sup>	250	kHz
		Synchronization range	250 <sup>(5)</sup>		350 <sup>(5)</sup>	
	high-level input voltage		3.5		6	V
	low-level input voltage		-0.3		0.5	V
	clock duty cycle		25		75	%
$C_I$	External input capacitance		0	47		$\mu\text{F}$
$C_O$	External output capacitance		0	47 <sup>(6)</sup>	1000	$\mu\text{F}$
$V_{ISO}$	Isolation voltage	Primary-Secondary	1,500			Vdc
$C_{ISO}$	Isolation capacitance		1,100			pF
$R_{ISO}$	Isolation resistance		10			M $\Omega$

- (1) The converter requires a minimum load current for proper operation. However, the converter is not damaged when operated under a no-load condition.
- (2) See temperature derating curves for safe operating area (SOA), to determine output current derating at elevated ambient temperatures.
- (3) The set-point voltage tolerance is affected by the tolerance and stability of  $R_{TRIM}$ . The stated limit is unconditionally met if  $R_{TRIM}$  has a tolerance of  $\leq 1\%$ , with  $\leq 100\text{ ppm}/^\circ\text{C}$  temperature stability.
- (4) The Enable input (pin 3) has an internal pullup resistor. Do not place an external pullup resistor on this input pin. If the enable feature is not used, for a positive enable device this input should be left open circuit and a negative enable device should be permanently connected to  $V_{I-}$  (pin 2). A discrete MOSFET or bipolar transistor is recommended for the enable control. The open-circuit voltage is typically less than 5 V. See the *Application Information* for a more detailed description.
- (5) A device with the synchronization option has a reduced switching frequency of 215 kHz typical. The synchronization frequency can only be adjusted to a higher frequency, up to 350 kHz maximum.
- (6) An output capacitor is not required for proper operation. However, additional capacitance at the load will improve the transient response.

**PTMA401120 ELECTRICAL CHARACTERISTICS**
 $T_A = 25^\circ\text{C}$ ,  $V_I = 48\text{ V}$ ,  $V_O = 12\text{ V}$ ,  $C_I = 0\ \mu\text{F}$ ,  $C_O = 0\ \mu\text{F}$ , and  $I_O = I_{O\text{max}}$  (Unless otherwise stated)

PARAMETER		TEST CONDITIONS	PTMA401120			UNIT
			MIN	TYP	MAX	
$P_O$	Output power	Over $V_I$ range			12	W
$I_O$	Output current	Over $V_I$ range	0.1 (1)		1 (2)	A
$I_{LIM}$	Current Limit Threshold	Shutdown, followed by autorecovery		1.5		A
$V_I$	Input voltage range	Over $I_O$ range	36	48	75	V
$V_O$	Set-point voltage tolerance			$\pm 2$ (3)		$\%V_O$
	Temperature variation	$-40^\circ\text{C} \leq T_A \leq 85^\circ\text{C}$		$\pm 1$		$\%V_O$
	Line regulation	Over $V_I$ range		10		mV
	Load regulation	Over $I_O$ range		3		mV
	Total output voltage variation	Includes set-point, line, load, $-40^\circ\text{C} \leq T_A \leq 85^\circ\text{C}$		3	5 (3)	$\%V_O$
	Trim adjust range	Over $V_I$ range		10.8		13.2
$\eta$	Efficiency	$P_O = P_{O\text{max}}$		87%		
	$V_O$ Ripple (peak-to-peak)	20-MHz bandwidth		85		$\text{mV}_{pp}$
	Transient Response	0.1 A/ $\mu\text{s}$ load step, 50% to 100% $I_{O\text{max}}$	Recovery time		400	$\mu\text{s}$
			$V_O$ over/undershoot		$\pm 250$	mV
Output enable input (pin 3)	Referenced to $V_{I-}$	Input high voltage ( $V_{IH}$ )	4.5		Open (4)	V
		Input low voltage ( $V_{IL}$ )	-0.2		0.8	
		Input low current ( $I_{IL}$ )		1		
	Standby input current	Pin 3 open		8		mA
UVLO	Undervoltage lockout		32		34	V
OVP	Output Overvoltage Protection		13.5		17.5	V
$f_S$	Switching frequency	Over $V_I$ range	250	300	350	kHz
SYNC	Sync switching frequency	Free-running	180	215 (5)	250	kHz
		Synchronization range	250 (5)		350 (5)	
	high-level input voltage		3.5		6	V
	low-level input voltage		-0.3		0.5	V
	clock duty cycle		25		75	%
$C_I$	External input capacitance		0	47		$\mu\text{F}$
$C_O$	External output capacitance		0	47(6)	220	$\mu\text{F}$
$V_{ISO}$	Isolation voltage	Primary-Secondary	1,500			Vdc
$C_{ISO}$	Isolation capacitance		1,100			pF
$R_{ISO}$	Isolation resistance		10			M $\Omega$

- (1) The converter requires a minimum load current for proper operation. The converter is not damaged when operated under a no-load condition.
- (2) See temperature derating curves for safe operating area (SOA), to determine output current derating at elevated ambient temperatures.
- (3) The set-point voltage tolerance is affected by the tolerance and stability of  $R_{TRIM}$ . The stated limit is unconditionally met if  $R_{TRIM}$  has a tolerance of 1%, with 100 ppm/ $^\circ\text{C}$  temperature stability.
- (4) The Enable input (pin 3) has an internal pullup resistor. Do not place an external pullup resistor on this input pin. If the enable feature is not used, for a positive enable device this input should be left open circuit and a negative enable device should be permanently connected to  $V_{I-}$  (pin 2). A discrete MOSFET or bipolar transistor is recommended for the enable control. The open-circuit voltage is typically less than 5 V. See the *Application Information* for a more detailed description.
- (5) A device with the synchronization option has a reduced switching frequency of 215 kHz typical. The synchronization frequency can only be adjusted to a higher frequency, up to 350 kHz maximum.
- (6) An output capacitor is not required for proper operation. However, additional capacitance at the load will improve the transient response.

**TERMINAL FUNCTIONS**

TERMINAL		DESCRIPTION
NAME	NO.	
Enable/Sync <sup>(1)</sup>	3	The Enable input is an open-base logic input that is referenced to $V_{I-}$ . Two ON/OFF enable options are available, positive logic and negative logic. Positive logic devices are enabled by applying a logic high voltage (Open) and are disabled by applying a logic low voltage ( $V_{I-}$ ). Negative logic devices are enabled by applying a logic low voltage ( $V_{I-}$ ) and are disabled by applying a logic high voltage (Open). See the Application Information section for more detailed information. This pin also has the option of a synchronization input. A module that has the synchronization option does not have ON/OFF enable control. A 5-V logic signal greater than the free-running frequency but $\leq 350$ kHz is required for synchronization control. See the Application Information section for more detailed information.
$V_{I-}^{(1)}$	2	The negative input supply for the module, and the 0-V reference for the Enable/Sync inputs. When powering the module from a positive source, this input is connected to the input source return.
$V_{I+}^{(1)}$	1	The positive input for the module with respect to $V_{I-}$ . When powering the module from a negative input voltage, this input is connected to the input source ground.
$V_{O+}$	4	This is the positive power output with respect to $V_{O-}$ . It is dc isolated from the input power pins.
Trim	5	This pin allows the output voltage set point of the module to be increased or decreased up to $\pm 10\%$ . Connecting a resistor between this terminal and $V_{O+}$ decreases the output voltage set point. Connecting a resistor between this terminal and $V_{O-}$ increases the output voltage set point. A 0.05-W rated resistor may be used, with tolerance and temperature stability of 1% and 100 ppm/ $^{\circ}$ C, respectively. If left open circuit, the converter output voltage defaults to its nominal value. The specification table gives the standard resistor values for the most common output voltages.
$V_{O-}$	6	This is the output power return for the $V_{O+}$ bus. This terminal should be connected to the common of the load circuit.

(1) These functions indicate signals electrically common with the input.

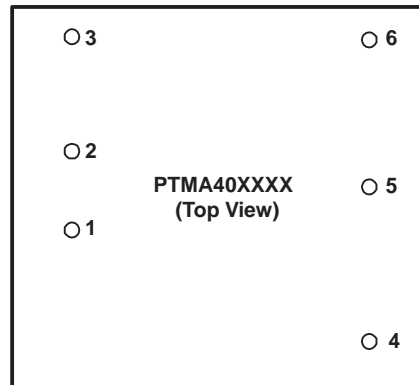

TYPICAL CHARACTERISTICS

PTMA403033 Characteristic Data ( $V_O = 3.3\text{ V}$ ) <sup>(1)(2)</sup>

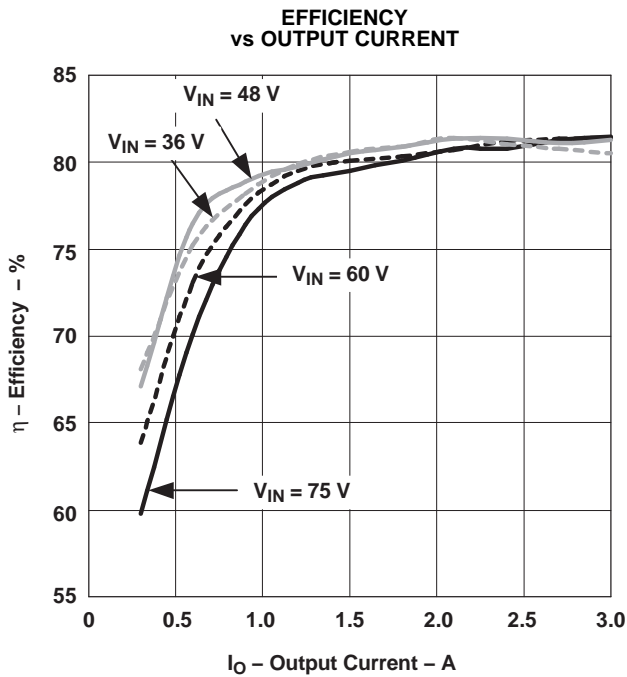

Figure 1.

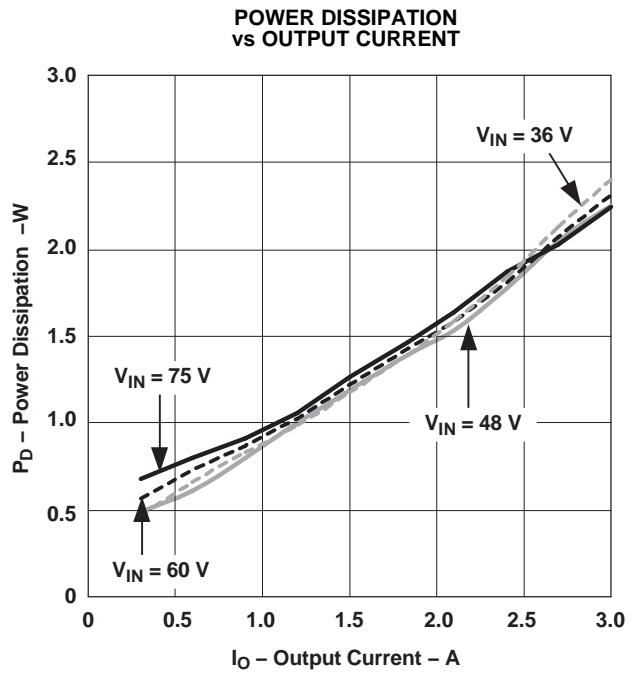

Figure 2.

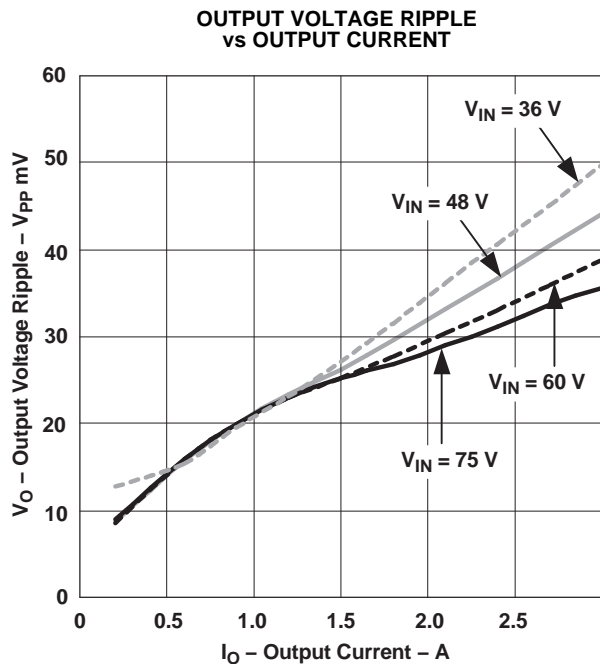

Figure 3.

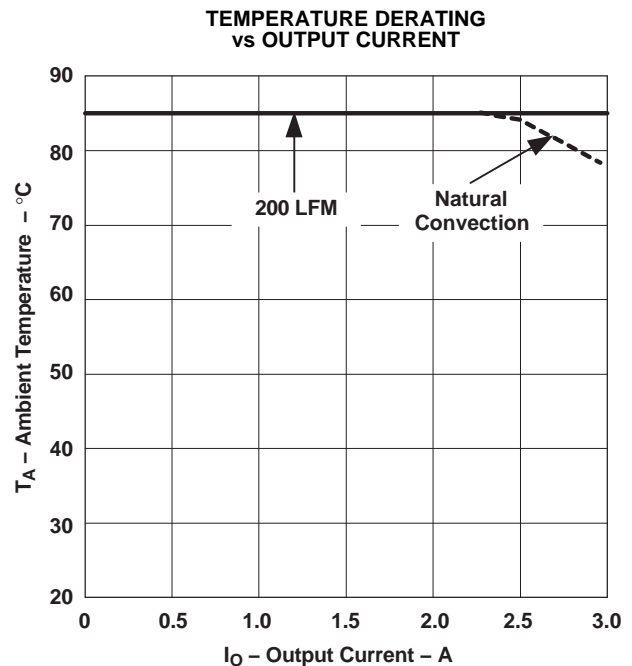

Figure 4.

- (1) All data listed in [Figure 1](#), [Figure 2](#), and [Figure 3](#) have been developed from actual products tested at 25°C. This data is considered typical data for the dc-dc converter.
- (2) The temperature derating curves represent operating conditions at which internal components are at or below manufacturer's maximum rated operating temperature. Derating limits apply to modules soldered directly to a 100-mm × 100-mm, double-sided PCB with 2 oz. copper. For surface mount packages, multiple vias (plated through holes) are required to add thermal paths around the power pins. Please refer to the mechanical specification for more information. Applies to [Figure 4](#).

TYPICAL CHARACTERISTICS (continued)

PTMA402050 Characteristic Data ( $V_O = 5\text{ V}$ ) <sup>(3)(4)</sup>

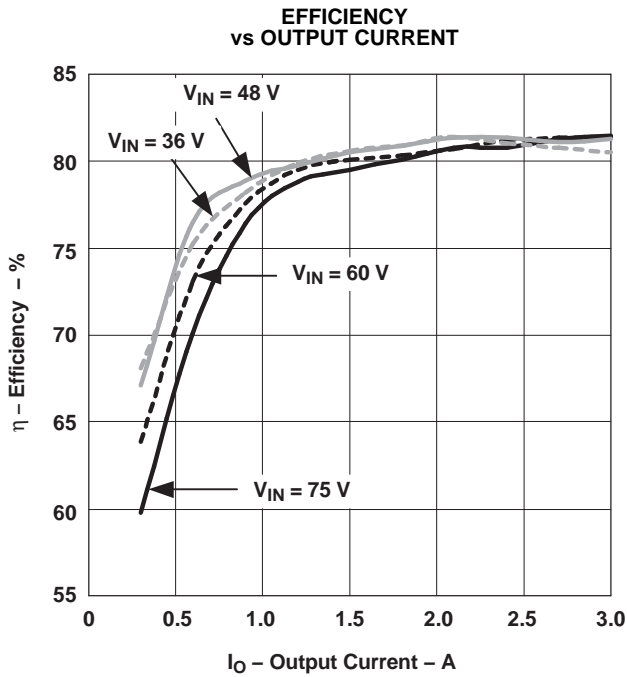

Figure 5.

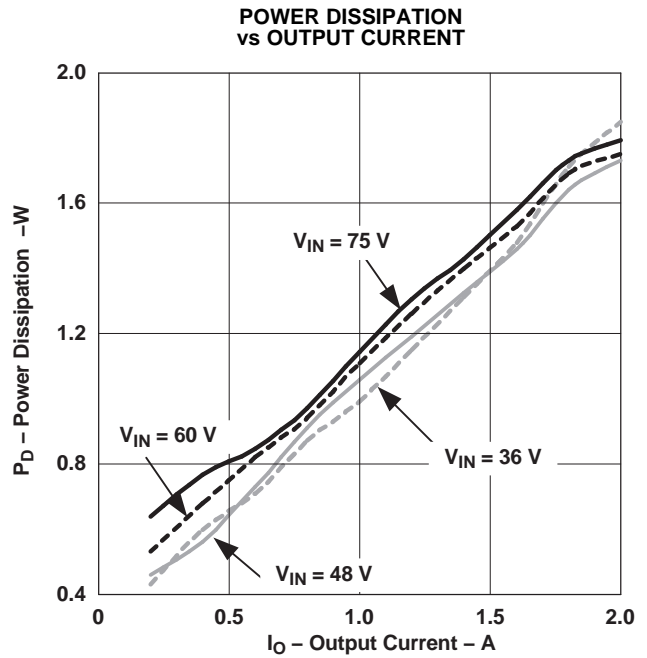

Figure 6.

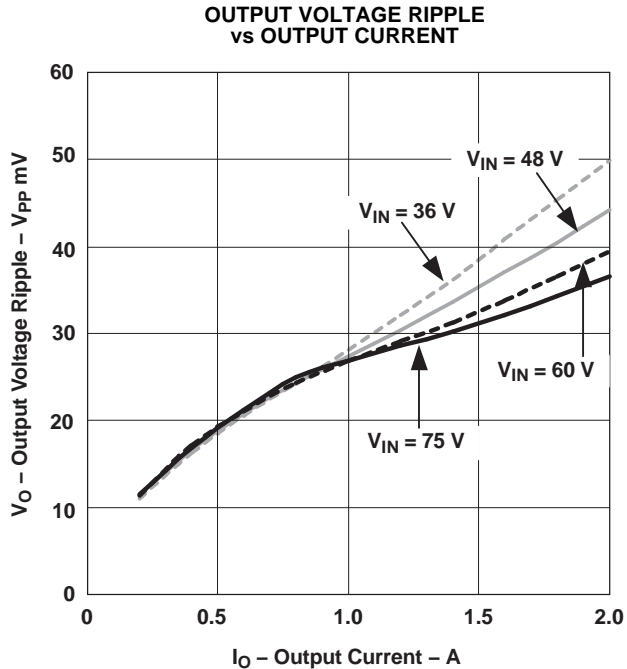

Figure 7.

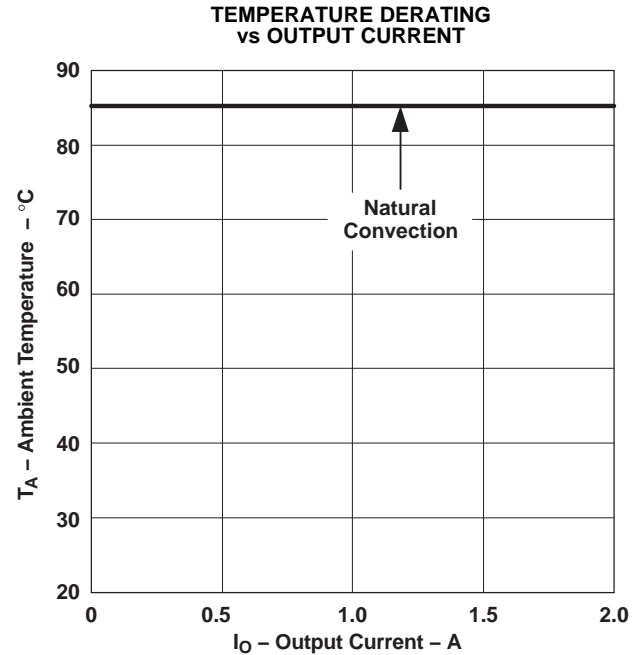

Figure 8.

- (3) All data listed in [Figure 5](#), [Figure 7](#), and [Figure 6](#) have been developed from actual products tested at 25°C. This data is considered typical data for the dc-dc converter.
- (4) The temperature derating curves represent operating conditions at which internal components are at or below manufacturer's maximum rated operating temperature. Derating limits apply to modules soldered directly to a 100-mm x 100-mm, double-sided PCB with 2 oz. copper. For surface mount packages, multiple vias (plated through holes) are required to add thermal paths around the power pins. Please refer to the mechanical specification for more information. Applies to [Figure 8](#).

TYPICAL CHARACTERISTICS (continued)

PTMA401120 Characteristic Data ( $V_O = 12\text{ V}$ ) <sup>(5)(6)</sup>

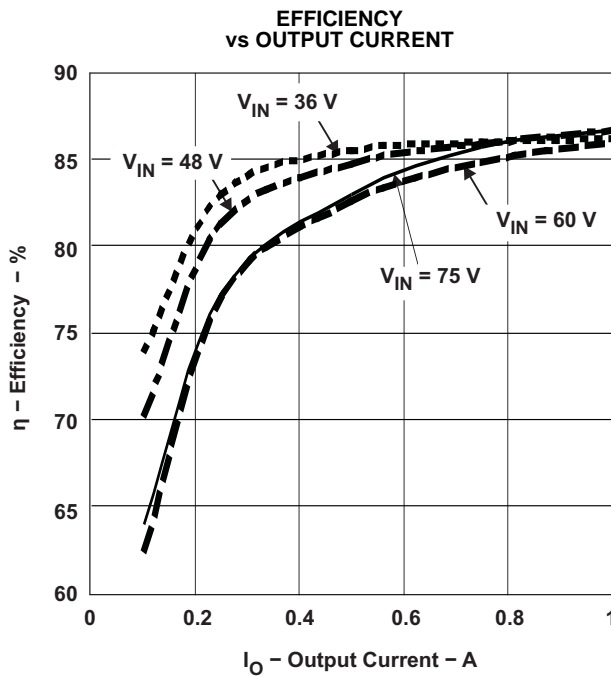

Figure 9.

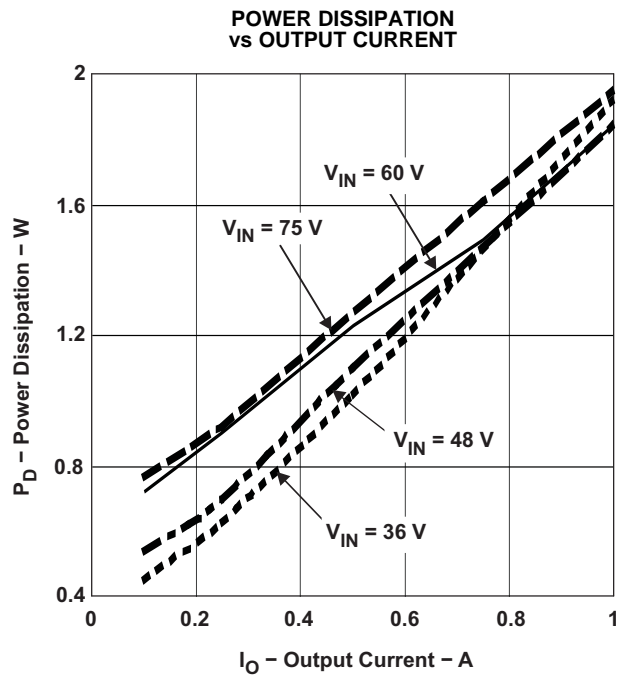

Figure 10.

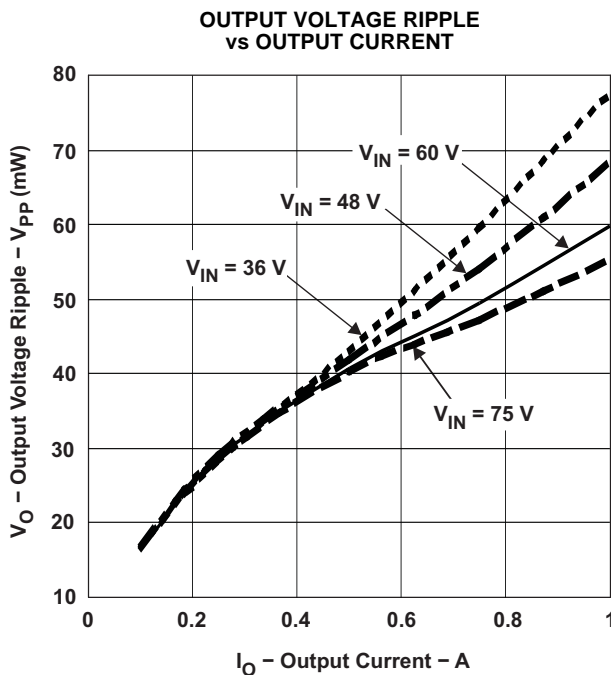

Figure 11.

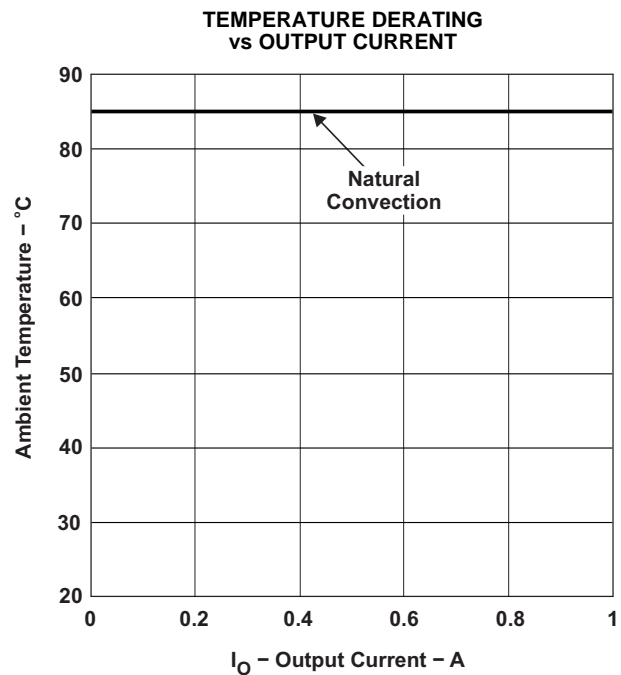

Figure 12.

- (5) All data listed in [Figure 9](#), [Figure 10](#), and [Figure 11](#) have been developed from actual products tested at 25°C. This data is considered typical data for the dc-dc converter.
- (6) The temperature derating curves represent operating conditions at which internal components are at or below manufacturer's maximum rated operating temperature. Derating limits apply to modules soldered directly to a 100-mm × 100-mm, double-sided PCB with 2 oz. copper. For surface mount packages, multiple vias (plated through holes) are required to add thermal paths around the power pins. Please refer to the mechanical specification for more information. Applies to [Figure 12](#).

## APPLICATION INFORMATION

### Operating Features and System Considerations for the PTMA40XX DC/DC Converters

#### Primary-Secondary Isolation

These converters incorporate electrical isolation between the input terminals (primary) and the output terminals (secondary). All converters are tested to a withstand voltage of 1500 Vdc. This complies with UL/cUL 60950 and EN 60950 and the requirements for functional isolation. It allows the converter to be configured for either a positive or negative input voltage source. The data sheet *Terminal Functions* table provides guidance as to the correct reference that must be used for the external control signals.

#### Undervoltage Lockout

The undervoltage lockout (UVLO) is designed to prevent the operation of the converter until the input voltage is close to the minimum operating voltage. The converter is held off when the input voltage is below the UVLO threshold, and turns on when the input voltage rises above the threshold. This prevents high start-up current during normal power up of the converter, and minimizes the current drain from the input source during low input voltage conditions. The converter meets full specifications when the minimum specified input voltage is reached. The UVLO circuitry also overrides the operation of the enable or synchronization controls. Only when the input voltage is above the UVLO threshold does this input become functional.

#### Output Overvoltage Clamp

The module is protected from an overvoltage on the output using an internal clamp. This protects against a break in the feedback path as well as a ground fault on the external Trim resistor, which would cause the output voltage to increase.

#### Overcurrent Protection

To protect against load faults, these converters incorporate output overcurrent protection. Applying a load to the output that exceeds the converter overcurrent threshold (see applicable specification) causes the output voltage to momentarily fold back, and then shut down. Following shutdown, the module periodically attempts to automatically recover by initiating a soft-start power up. This is often described as a *hiccup* mode of operation, whereby the module continues in the cycle of successive shutdown and power up until the load fault is removed. Once the fault is removed, the converter automatically recovers and returns to normal operation.

#### Soft-Start Power Up

When the converter is first powered, the internal soft-start circuit limits how fast the output voltage can rise. The soft-start circuit functions after a valid input source is applied and the output is enabled, after the converter output is enabled using the Enable input, or on a recovery from a load fault. The purpose of the soft-start feature is to limit the surge of current drawn from the input source when the converter begins to operate. By limiting the rate at which the output voltage rises, the magnitude of current required to charge up the load circuit capacitance is significantly reduced.

**Figure 13** shows the power-up characteristic of a PTMA403033 converter. The output voltage is 3.3 V. The soft-start circuit causes a slow, soft rise of the output voltage. The output voltage will begin to rise after a time delay (typically 85 ms-100 ms) once a valid input voltage is applied. The output then progressively rises to the voltage set-point. The waveforms were recorded with a resistive load of 3 A.

**APPLICATION INFORMATION (continued)**

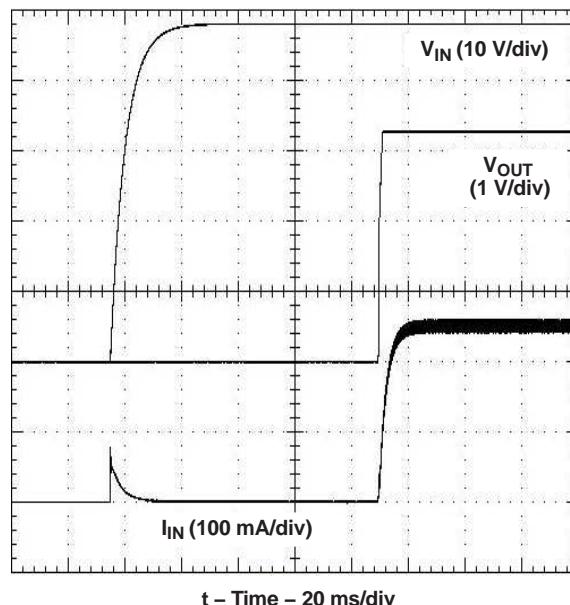

**Figure 13. Power-up Waveforms**

**Output Voltage Trim Adjustment**

An external resistor is required to increase or decrease the output voltage set point of the module by  $\pm 10\%$ . The resistor,  $R_{TRIM}$ , must be connected between the TRIM pin (pin 5) and  $V_{O+}$  (pin 4) to decrease the output voltage, or between the TRIM pin and  $V_{O-}$  (pin 6) to increase the output voltage. A 0.05-W rated resistor can be used. The tolerance should be 1%, with a temperature stability of 100 ppm/ $^{\circ}$ C (or better). Place the resistor close to the converter and connect it using dedicated PCB traces (see [Figure 14](#)). [Table 1](#) gives the nearest standard value of external resistor for the common voltages within each model's adjust range.

**Table 1. Standard Values of  $R_{TRIM}$  for Common Output Voltages**

PTMA403033			PTMA402050			PTMA401120		
$V_O$ (required)	$R_{TRIM}$ (k $\Omega$ )		$V_O$ (required)	$R_{TRIM}$ (k $\Omega$ )		$V_O$ (required)	$R_{TRIM}$ (k $\Omega$ )	
	down	up		down	up		down	up
3.0 V	118	—	4.5 V	18.7	—	10.8 V	64.9	—
3.1 V	187	—	4.6 V	24.9	—	11.0 V	80.6	—
3.2 V	392	—	4.7 V	35.7	—	11.2 V	105	—
3.3 V	open	open	4.8 V	57.6	—	11.4 V	143	—
3.4 V	—	249	4.9 V	121	—	11.6 V	221	—
3.5 V	—	124	5.0 V	open	open	11.8 V	464	—
3.6 V	—	82.5	5.1 V	—	124	12.0 V	open	open
—	—	—	5.2 V	—	61.9	12.2 V	—	118
—	—	—	5.3 V	—	40.2	12.4 V	—	57.6
—	—	—	5.4 V	—	29.4	12.6 V	—	36.5
—	—	—	5.5 V	—	23.2	12.8 V	—	26.1
—	—	—	—	—	—	13.0 V	—	19.6
—	—	—	—	—	—	13.2 V	—	15.8

For other output voltages, the value of the required trim resistor may be calculated using Equation 1 to adjust the voltage up or Equation 2 to adjust the voltage down.

$$R_{\text{TRIM(up)}} = \frac{R_O \times V_R}{(V_O - V_{\text{SET}})} - R_P \text{ (k}\Omega\text{)} \quad (1)$$

$$R_{\text{TRIM(dwn)}} = \frac{R_O \times (V_O - V_R)}{(V_{\text{SET}} - V_O)} - R_P \text{ (k}\Omega\text{)} \quad (2)$$

Table 2 gives the required  $R_{\text{TRIM}}$  equation constants for the converter model selected. To calculate the required value of  $R_{\text{TRIM}}$ , simply locate the applicable constants and substitute these into the formula along with the desired output voltage.

**Table 2. Trim Adjust Equation Constants**

Constants	PTMA403033	PTMA402050	PTMA401120
$V_R$ (V)	1.24	2.50	2.50
$R_O$ ( $\Omega$ )	20	5.11	10
$R_P$ ( $\Omega$ )	1.0	2.05	5.11
$V_{\text{SET}}$ (V)	3.3	5.0	12.0
$V_O$ (V)	Desired Output Voltage	Desired Output Voltage	Desired Output Voltage

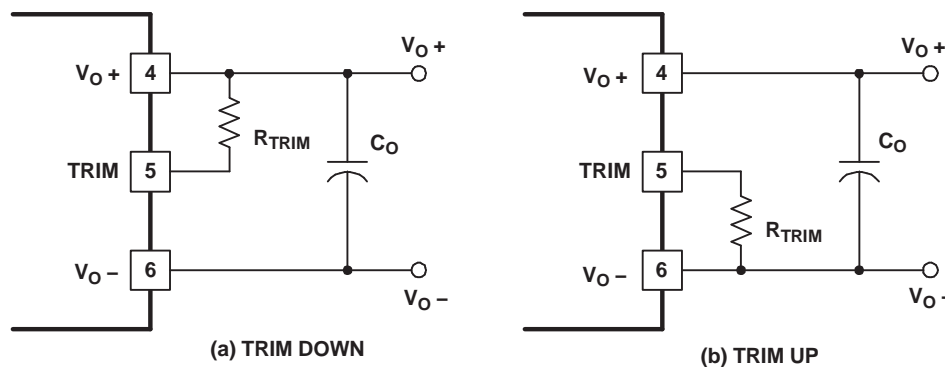

**Figure 14. Output Voltage Adjustment**

### Thermal Considerations

Airflow may be necessary to ensure that the module can supply the desired load current in environments with elevated ambient temperatures. The required airflow rate is determined from the safe operating area (SOA). The SOA is the area beneath the applicable airflow rate curve on the graph of temperature derating vs output current. (See the Typical Characteristics.) Operating the converter within the SOA limits ensures that all the internal components are at or below their stated maximum operating temperatures.

### On/Off Enable Controls

On/Off enable options include positive logic or negative logic. A positive logic device enables the module's output when a logic high voltage is present on the Enable pin (pin 3) and disables the output with a logic low voltage. A negative logic device disables the output when a logic high voltage is present on the Enable pin and enables the output during a logic low voltage. See the Electrical Characteristics table for logic high and logic low limits. The Enable pin is ideally controlled with an open-collector (or open-drain) discrete transistor. See Figure 15 below for a typical On/Off Enable control circuit. For automatic start-up, the Enable pin should be left open for a positive logic module and should be shorted to  $V_{I-}$  (pin 2) for a negative logic module. Both inputs are electrically referenced to  $V_{I-}$  on the primary (input) side of the converter. Do not place an external pull-up resistor on this input pin.

## Enable Control Schematic

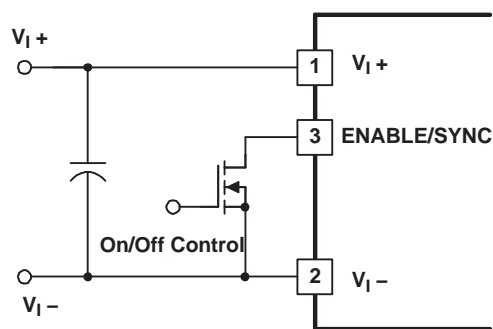

Figure 15. Typical On/Off Enable Control Circuit

## On/Off Enable Turn-On Time

Once enabled, the converter executes a soft-start power up. The converter exhibits a short delay of approximately 100  $\mu$ s, measured from the transition of the enable signal to the instance the  $V_O$  Bus output begins to rise. The output is in regulation within 1.5 ms.

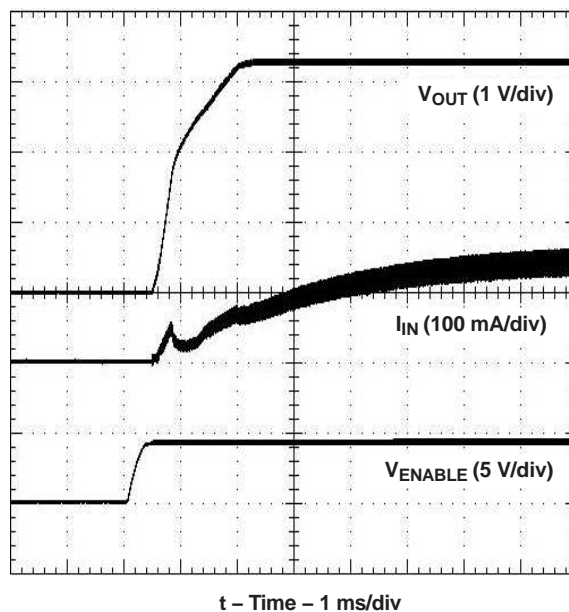

Figure 16. Output Enable Power-Up Characteristic

## Synchronization

The Synchronization option allows multiple power modules to be synchronized to a common frequency. Driving the Sync pin (pin 3) with an external clock set to the desired frequency, synchronizes all connected modules to that frequency. Modules with the synchronization option have a reduced free-running switching frequency of 215 kHz typical. The synchronization frequency can only be adjusted to a higher frequency, up to 350 kHz. A 5-V logic signal is recommended for control. See Figure 17. See the Electrical Characteristics table for synchronization limits.

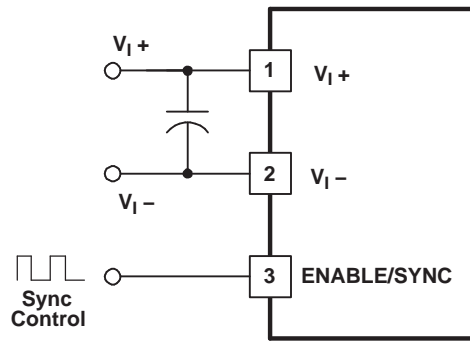

Figure 17. Synchronization Control

## MECHANICALS

### Tape and Reel

ITEM	DESCRIPTION	PART NO.
1	TAPE & REEL, PTMA4	076-00345
2	MICROSEAL COVER TAPE, 44mm	076-00119
3	BIO-REEL 15" DIA., 44mm TAPE	076-00094

NOTES:  
 1) PROCESS IN ACCORDANCE WITH EIA-481-2  
 \* TAPE LEADER DIMENSION 15.30" MIN.  
 \* TAPE TRAILER DIMENSION 6.30" MIN.  
 2) PARTS SHOULD BE PACKAGED IN ACCORDANCE WITH ESD GUIDELINES IN EIA-541.  
 3) REEL LABEL: \*A\*- \*TI PART NUMBER.  
 \* QUANTITY  
 \* DATE CODE  
 \* LOT NUMBER  
 \* MSL DATA  
 \* MADE IN  
 \* ASSY SITE ORIGIN  
 \* COUNTRY OF ORIGIN  
 \* SUPPLIER  
 \*B\*- ANTI-STATIC CAUTION LABEL  
 4) NO REQUIREMENT FOR TAPE DIRECTION OF FEED FROM SUPPLIER REEL.

PTXXXX0X	*X*	*Y*
PTMA4	1.40mm	20.50mm

TOLERANCES UNLESS OTHERWISE SPECIFIED  
 .XX = ±0.005 HOLES = ±0.001  
 .XXX = ±0.003 ANGLES = ± 1/2"

DEVICE SUFFIX	INFO
TAPE WIDTH	44mm (1.732")
PITCH	32mm (1.260")
REEL SIZE	15" DIA.
DEVICES/REEL	250

© This Document and the information contained herein is confidential and proprietary to Texas Instruments, and may not be reproduced or used for any purpose without the expressed written permission of Texas Instruments.



**MECHANICALS (continued)**

**Tray**

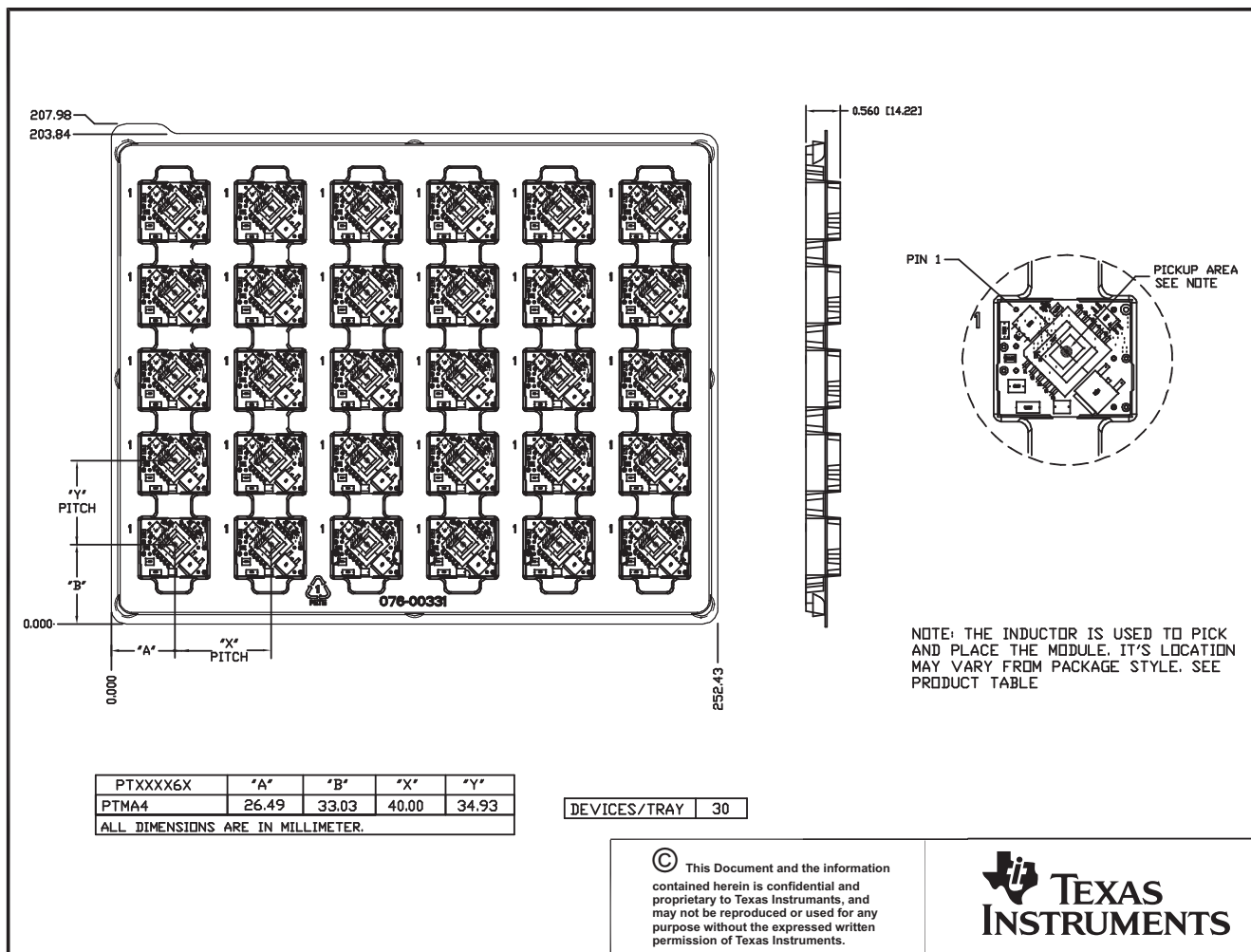

© This Document and the information contained herein is confidential and proprietary to Texas Instruments, and may not be reproduced or used for any purpose without the expressed written permission of Texas Instruments.



**PACKAGING INFORMATION**

Orderable Device	Status <sup>(1)</sup>	Package Type	Package Drawing	Pins	Package Qty	Eco Plan <sup>(2)</sup>	Lead/ Ball Finish	MSL Peak Temp <sup>(3)</sup>	Samples (Requires Login)
PTMA401120A1AD	ACTIVE	Through-Hole Module	EEP	4	30	Pb-Free (RoHS)	SN	N / A for Pkg Type	<a href="#">Request Free Samples</a>
PTMA401120A1AS	ACTIVE	Surface Mount Module	EET	4	30	TBD	SNPB	Level-1-235C-UNLIM/ Level-3-260C-168HRS	<a href="#">Purchase Samples</a>
PTMA401120A1AST	ACTIVE	Surface Mount Module	EET	4	250	TBD	SNPB	Level-1-235C-UNLIM/ Level-3-260C-168HRS	<a href="#">Purchase Samples</a>
PTMA401120A1AZ	ACTIVE	Surface Mount Module	BET	4	30	Pb-Free (RoHS)	SNAGCU	Level-3-260C-168 HR	<a href="#">Request Free Samples</a>
PTMA401120A1AZT	ACTIVE	Surface Mount Module	BET	4	250	Pb-Free (RoHS)	SNAGCU	Level-3-260C-168 HR	<a href="#">Purchase Samples</a>
PTMA401120A2AD	ACTIVE	Through-Hole Module	EEV	5	30	Pb-Free (RoHS)	SN	N / A for Pkg Type	<a href="#">Request Free Samples</a>
PTMA401120A2AS	ACTIVE	Surface Mount Module	EEW	5	30	TBD	SNPB	Level-1-235C-UNLIM/ Level-3-260C-168HRS	<a href="#">Purchase Samples</a>
PTMA401120A2AST	ACTIVE	Surface Mount Module	EEW	5	250	TBD	SNPB	Level-1-235C-UNLIM/ Level-3-260C-168HRS	<a href="#">Purchase Samples</a>
PTMA401120A2AZ	ACTIVE	Surface Mount Module	BEW	5	30	Pb-Free (RoHS)	SNAGCU	Level-3-260C-168 HR	<a href="#">Request Free Samples</a>
PTMA401120A2AZT	ACTIVE	Surface Mount Module	BEW	5	250	Pb-Free (RoHS)	SNAGCU	Level-3-260C-168 HR	<a href="#">Purchase Samples</a>
PTMA401120A3AD	ACTIVE	Through-Hole Module	EEP	6	30	Pb-Free (RoHS)	SN	N / A for Pkg Type	<a href="#">Request Free Samples</a>
PTMA401120A3AS	ACTIVE	Surface Mount Module	EET	6	30	TBD	SNPB	Level-1-235C-UNLIM/ Level-3-260C-168HRS	<a href="#">Purchase Samples</a>
PTMA401120A3AST	ACTIVE	Surface Mount Module	EET	6	250	TBD	SNPB	Level-1-235C-UNLIM/ Level-3-260C-168HRS	<a href="#">Purchase Samples</a>
PTMA401120A3AZ	ACTIVE	Surface Mount Module	BET	6	30	Pb-Free (RoHS)	SNAGCU	Level-3-260C-168 HR	<a href="#">Request Free Samples</a>
PTMA401120A3AZT	ACTIVE	Surface Mount Module	BET	6	250	Pb-Free (RoHS)	SNAGCU	Level-3-260C-168 HR	<a href="#">Purchase Samples</a>
PTMA401120N1AD	ACTIVE	Through-Hole Module	EEP	5	30	Pb-Free (RoHS)	SN	N / A for Pkg Type	<a href="#">Request Free Samples</a>
PTMA401120N1AS	ACTIVE	Surface Mount Module	EET	5	30	TBD	SNPB	Level-1-235C-UNLIM/ Level-3-260C-168HRS	<a href="#">Purchase Samples</a>

Orderable Device	Status <sup>(1)</sup>	Package Type	Package Drawing	Pins	Package Qty	Eco Plan <sup>(2)</sup>	Lead/ Ball Finish	MSL Peak Temp <sup>(3)</sup>	Samples (Requires Login)
PTMA401120N1AST	ACTIVE	Surface Mount Module	EET	5	250	TBD	SNPB	Level-1-235C-UNLIM/ Level-3-260C-168HRS	<a href="#">Purchase Samples</a>
PTMA401120N1AZ	ACTIVE	Surface Mount Module	BET	5	30	Pb-Free (RoHS)	SNAGCU	Level-3-260C-168 HR	<a href="#">Request Free Samples</a>
PTMA401120N1AZT	ACTIVE	Surface Mount Module	BET	5	250	Pb-Free (RoHS)	SNAGCU	Level-3-260C-168 HR	<a href="#">Purchase Samples</a>
PTMA401120N2AD	ACTIVE	Through-Hole Module	EEP	6	30	Pb-Free (RoHS)	SN	N / A for Pkg Type	<a href="#">Request Free Samples</a>
PTMA401120N2AS	ACTIVE	Surface Mount Module	EET	6	30	TBD	SNPB	Level-1-235C-UNLIM/ Level-3-260C-168HRS	<a href="#">Request Free Samples</a>
PTMA401120N2AST	ACTIVE	Surface Mount Module	EET	6	250	TBD	SNPB	Level-1-235C-UNLIM/ Level-3-260C-168HRS	<a href="#">Purchase Samples</a>
PTMA401120N2AZ	ACTIVE	Surface Mount Module	BET	6	30	Pb-Free (RoHS)	SNAGCU	Level-3-260C-168 HR	<a href="#">Request Free Samples</a>
PTMA401120N2AZT	ACTIVE	Surface Mount Module	BET	6	250	Pb-Free (RoHS)	SNAGCU	Level-3-260C-168 HR	<a href="#">Purchase Samples</a>
PTMA401120P1AD	ACTIVE	Through-Hole Module	EEP	5	30	Pb-Free (RoHS)	SN	N / A for Pkg Type	<a href="#">Request Free Samples</a>
PTMA401120P1AS	ACTIVE	Surface Mount Module	EET	5	30	TBD	SNPB	Level-1-235C-UNLIM/ Level-3-260C-168HRS	<a href="#">Purchase Samples</a>
PTMA401120P1AST	ACTIVE	Surface Mount Module	EET	5	250	TBD	SNPB	Level-1-235C-UNLIM/ Level-3-260C-168HRS	<a href="#">Purchase Samples</a>
PTMA401120P1AZ	ACTIVE	Surface Mount Module	BET	5	30	Pb-Free (RoHS)	SNAGCU	Level-3-260C-168 HR	<a href="#">Request Free Samples</a>
PTMA401120P1AZT	ACTIVE	Surface Mount Module	BET	5	250	Pb-Free (RoHS)	SNAGCU	Level-3-260C-168 HR	<a href="#">Purchase Samples</a>
PTMA401120P2AD	ACTIVE	Through-Hole Module	EEP	6	30	Pb-Free (RoHS)	SN	N / A for Pkg Type	<a href="#">Request Free Samples</a>
PTMA401120P2AS	ACTIVE	Surface Mount Module	EET	6	30	TBD	SNPB	Level-1-235C-UNLIM/ Level-3-260C-168HRS	<a href="#">Purchase Samples</a>
PTMA401120P2AST	ACTIVE	Surface Mount Module	EET	6	250	TBD	SNPB	Level-1-235C-UNLIM/ Level-3-260C-168HRS	<a href="#">Purchase Samples</a>
PTMA401120P2AZ	ACTIVE	Surface Mount Module	BET	6	30	Pb-Free (RoHS)	SNAGCU	Level-3-260C-168 HR	<a href="#">Request Free Samples</a>
PTMA401120P2AZT	ACTIVE	Surface Mount Module	BET	6	250	Pb-Free (RoHS)	SNAGCU	Level-3-260C-168 HR	<a href="#">Purchase Samples</a>

Orderable Device	Status <sup>(1)</sup>	Package Type	Package Drawing	Pins	Package Qty	Eco Plan <sup>(2)</sup>	Lead/ Ball Finish	MSL Peak Temp <sup>(3)</sup>	Samples (Requires Login)
PTMA402050A1AD	ACTIVE	Through-Hole Module	EEP	4	30	Pb-Free (RoHS)	SN	N / A for Pkg Type	<a href="#">Purchase Samples</a>
PTMA402050A1AS	ACTIVE	Surface Mount Module	EET	4	30	TBD	SNPB	Level-1-235C-UNLIM/ Level-3-260C-168HRS	<a href="#">Purchase Samples</a>
PTMA402050A1AST	ACTIVE	Surface Mount Module	EET	4	250	TBD	SNPB	Level-1-235C-UNLIM/ Level-3-260C-168HRS	<a href="#">Purchase Samples</a>
PTMA402050A1AZ	ACTIVE	Surface Mount Module	BET	4	30	Pb-Free (RoHS)	SNAGCU	Level-3-260C-168 HR	<a href="#">Request Free Samples</a>
PTMA402050A1AZT	ACTIVE	Surface Mount Module	BET	4	250	Pb-Free (RoHS)	SNAGCU	Level-3-260C-168 HR	<a href="#">Purchase Samples</a>
PTMA402050A2AD	ACTIVE	Through-Hole Module	EEV	5	30	Pb-Free (RoHS)	SN	N / A for Pkg Type	<a href="#">Purchase Samples</a>
PTMA402050A2AS	ACTIVE	Surface Mount Module	EEW	5	30	TBD	SNPB	Level-1-235C-UNLIM/ Level-3-260C-168HRS	<a href="#">Purchase Samples</a>
PTMA402050A2AST	ACTIVE	Surface Mount Module	EEW	5	250	TBD	SNPB	Level-1-235C-UNLIM/ Level-3-260C-168HRS	<a href="#">Purchase Samples</a>
PTMA402050A2AZ	ACTIVE	Surface Mount Module	BEW	5	30	Pb-Free (RoHS)	SNAGCU	Level-3-260C-168 HR	<a href="#">Purchase Samples</a>
PTMA402050A2AZT	ACTIVE	Surface Mount Module	BEW	5	250	Pb-Free (RoHS)	SNAGCU	Level-3-260C-168 HR	<a href="#">Purchase Samples</a>
PTMA402050A3AD	ACTIVE	Through-Hole Module	EEP	6	30	Pb-Free (RoHS)	SN	N / A for Pkg Type	<a href="#">Request Free Samples</a>
PTMA402050A3AS	ACTIVE	Surface Mount Module	EET	6	30	TBD	SNPB	Level-1-235C-UNLIM/ Level-3-260C-168HRS	<a href="#">Purchase Samples</a>
PTMA402050A3AST	ACTIVE	Surface Mount Module	EET	6	250	TBD	SNPB	Level-1-235C-UNLIM/ Level-3-260C-168HRS	<a href="#">Purchase Samples</a>
PTMA402050A3AZ	ACTIVE	Surface Mount Module	BET	6	30	Pb-Free (RoHS)	SNAGCU	Level-3-260C-168 HR	<a href="#">Request Free Samples</a>
PTMA402050A3AZT	ACTIVE	Surface Mount Module	BET	6	250	Pb-Free (RoHS)	SNAGCU	Level-3-260C-168 HR	<a href="#">Purchase Samples</a>
PTMA402050N1AD	ACTIVE	Through-Hole Module	EEP	5	30	Pb-Free (RoHS)	SN	N / A for Pkg Type	<a href="#">Purchase Samples</a>
PTMA402050N1AS	ACTIVE	Surface Mount Module	EET	5	30	TBD	SNPB	Level-1-235C-UNLIM/ Level-3-260C-168HRS	<a href="#">Purchase Samples</a>
PTMA402050N1AST	ACTIVE	Surface Mount Module	EET	5	250	TBD	SNPB	Level-1-235C-UNLIM/ Level-3-260C-168HRS	<a href="#">Purchase Samples</a>

Orderable Device	Status <sup>(1)</sup>	Package Type	Package Drawing	Pins	Package Qty	Eco Plan <sup>(2)</sup>	Lead/ Ball Finish	MSL Peak Temp <sup>(3)</sup>	Samples (Requires Login)
PTMA402050N1AZ	ACTIVE	Surface Mount Module	BET	5	30	Pb-Free (RoHS)	SNAGCU	Level-3-260C-168 HR	<a href="#">Purchase Samples</a>
PTMA402050N1AZT	ACTIVE	Surface Mount Module	BET	5	250	Pb-Free (RoHS)	SNAGCU	Level-3-260C-168 HR	<a href="#">Purchase Samples</a>
PTMA402050N2AD	ACTIVE	Through-Hole Module	EEP	6	30	Pb-Free (RoHS)	SN	N / A for Pkg Type	<a href="#">Request Free Samples</a>
PTMA402050N2AS	ACTIVE	Surface Mount Module	EET	6	30	TBD	SNPB	Level-1-235C-UNLIM/ Level-3-260C-168HRS	<a href="#">Request Free Samples</a>
PTMA402050N2AST	ACTIVE	Surface Mount Module	EET	6	250	TBD	SNPB	Level-1-235C-UNLIM/ Level-3-260C-168HRS	<a href="#">Purchase Samples</a>
PTMA402050N2AZ	ACTIVE	Surface Mount Module	BET	6	30	Pb-Free (RoHS)	SNAGCU	Level-3-260C-168 HR	<a href="#">Request Free Samples</a>
PTMA402050N2AZT	ACTIVE	Surface Mount Module	BET	6	250	Pb-Free (RoHS)	SNAGCU	Level-3-260C-168 HR	<a href="#">Purchase Samples</a>
PTMA402050P1AD	ACTIVE	Through-Hole Module	EEP	5	30	Pb-Free (RoHS)	SN	N / A for Pkg Type	<a href="#">Purchase Samples</a>
PTMA402050P1AS	ACTIVE	Surface Mount Module	EET	5	30	TBD	SNPB	Level-1-235C-UNLIM/ Level-3-260C-168HRS	<a href="#">Purchase Samples</a>
PTMA402050P1AST	ACTIVE	Surface Mount Module	EET	5	250	TBD	SNPB	Level-1-235C-UNLIM/ Level-3-260C-168HRS	<a href="#">Purchase Samples</a>
PTMA402050P1AZ	ACTIVE	Surface Mount Module	BET	5	30	Pb-Free (RoHS)	SNAGCU	Level-3-260C-168 HR	<a href="#">Purchase Samples</a>
PTMA402050P1AZT	ACTIVE	Surface Mount Module	BET	5	250	Pb-Free (RoHS)	SNAGCU	Level-3-260C-168 HR	<a href="#">Purchase Samples</a>
PTMA402050P2AD	ACTIVE	Through-Hole Module	EEP	6	30	Pb-Free (RoHS)	SN	N / A for Pkg Type	<a href="#">Request Free Samples</a>
PTMA402050P2AS	ACTIVE	Surface Mount Module	EET	6	30	TBD	SNPB	Level-1-235C-UNLIM/ Level-3-260C-168HRS	<a href="#">Purchase Samples</a>
PTMA402050P2AST	ACTIVE	Surface Mount Module	EET	6	250	TBD	SNPB	Level-1-235C-UNLIM/ Level-3-260C-168HRS	<a href="#">Purchase Samples</a>
PTMA402050P2AZ	ACTIVE	Surface Mount Module	BET	6	30	Pb-Free (RoHS)	SNAGCU	Level-3-260C-168 HR	<a href="#">Purchase Samples</a>
PTMA402050P2AZT	ACTIVE	Surface Mount Module	BET	6	250	Pb-Free (RoHS)	SNAGCU	Level-3-260C-168 HR	<a href="#">Purchase Samples</a>
PTMA403033A1AD	ACTIVE	Through-Hole Module	EEP	4	30	Pb-Free (RoHS)	SN	N / A for Pkg Type	<a href="#">Request Free Samples</a>

Orderable Device	Status <sup>(1)</sup>	Package Type	Package Drawing	Pins	Package Qty	Eco Plan <sup>(2)</sup>	Lead/ Ball Finish	MSL Peak Temp <sup>(3)</sup>	Samples (Requires Login)
PTMA403033A1AS	ACTIVE	Surface Mount Module	EET	4	30	TBD	SNPB	Level-1-235C-UNLIM/ Level-3-260C-168HRS	<a href="#">Purchase Samples</a>
PTMA403033A1AST	ACTIVE	Surface Mount Module	EET	4	250	TBD	SNPB	Level-1-235C-UNLIM/ Level-3-260C-168HRS	<a href="#">Purchase Samples</a>
PTMA403033A1AZ	ACTIVE	Surface Mount Module	BET	4	30	Pb-Free (RoHS)	SNAGCU	Level-3-260C-168 HR	<a href="#">Request Free Samples</a>
PTMA403033A1AZT	ACTIVE	Surface Mount Module	BET	4	200	Pb-Free (RoHS)	SNAGCU	Level-3-260C-168 HR	<a href="#">Purchase Samples</a>
PTMA403033A2AD	ACTIVE	Through-Hole Module	EEV	5	30	Pb-Free (RoHS)	SN	N / A for Pkg Type	<a href="#">Request Free Samples</a>
PTMA403033A2AS	ACTIVE	Surface Mount Module	EEW	5	30	TBD	SNPB	Level-1-235C-UNLIM/ Level-3-260C-168HRS	<a href="#">Purchase Samples</a>
PTMA403033A2AST	ACTIVE	Surface Mount Module	EEW	5	250	TBD	SNPB	Level-1-235C-UNLIM/ Level-3-260C-168HRS	<a href="#">Purchase Samples</a>
PTMA403033A2AZ	ACTIVE	Surface Mount Module	BEW	5	30	Pb-Free (RoHS)	SNAGCU	Level-3-260C-168 HR	<a href="#">Request Free Samples</a>
PTMA403033A2AZT	ACTIVE	Surface Mount Module	BEW	5	250	Pb-Free (RoHS)	SNAGCU	Level-3-260C-168 HR	<a href="#">Purchase Samples</a>
PTMA403033A3AD	ACTIVE	Through-Hole Module	EEP	6	30	Pb-Free (RoHS)	SN	N / A for Pkg Type	<a href="#">Request Free Samples</a>
PTMA403033A3AS	ACTIVE	Surface Mount Module	EET	6	30	TBD	SNPB	Level-1-235C-UNLIM/ Level-3-260C-168HRS	<a href="#">Purchase Samples</a>
PTMA403033A3AST	ACTIVE	Surface Mount Module	EET	6	250	TBD	SNPB	Level-1-235C-UNLIM/ Level-3-260C-168HRS	<a href="#">Purchase Samples</a>
PTMA403033A3AZ	ACTIVE	Surface Mount Module	BET	6	30	Pb-Free (RoHS)	SNAGCU	Level-3-260C-168 HR	<a href="#">Request Free Samples</a>
PTMA403033A3AZT	ACTIVE	Surface Mount Module	BET	6	250	Pb-Free (RoHS)	SNAGCU	Level-3-260C-168 HR	<a href="#">Purchase Samples</a>
PTMA403033N1AD	ACTIVE	Through-Hole Module	EEP	5	30	Pb-Free (RoHS)	SN	N / A for Pkg Type	<a href="#">Request Free Samples</a>
PTMA403033N1AS	ACTIVE	Surface Mount Module	EET	5	30	TBD	SNPB	Level-1-235C-UNLIM/ Level-3-260C-168HRS	<a href="#">Purchase Samples</a>
PTMA403033N1AST	ACTIVE	Surface Mount Module	EET	5	250	TBD	SNPB	Level-1-235C-UNLIM/ Level-3-260C-168HRS	<a href="#">Purchase Samples</a>
PTMA403033N1AZ	ACTIVE	Surface Mount Module	BET	5	30	Pb-Free (RoHS)	SNAGCU	Level-3-260C-168 HR	<a href="#">Request Free Samples</a>

Orderable Device	Status <sup>(1)</sup>	Package Type	Package Drawing	Pins	Package Qty	Eco Plan <sup>(2)</sup>	Lead/ Ball Finish	MSL Peak Temp <sup>(3)</sup>	Samples (Requires Login)
PTMA403033N1AZT	ACTIVE	Surface Mount Module	BET	5	250	Pb-Free (RoHS)	SNAGCU	Level-3-260C-168 HR	<a href="#">Purchase Samples</a>
PTMA403033N2AD	ACTIVE	Through-Hole Module	EEP	6	30	Pb-Free (RoHS)	SN	N / A for Pkg Type	<a href="#">Request Free Samples</a>
PTMA403033N2AS	ACTIVE	Surface Mount Module	EET	6	30	TBD	SNPB	Level-1-235C-UNLIM/ Level-3-260C-168HRS	<a href="#">Request Free Samples</a>
PTMA403033N2AST	ACTIVE	Surface Mount Module	EET	6	250	TBD	SNPB	Level-1-235C-UNLIM/ Level-3-260C-168HRS	<a href="#">Purchase Samples</a>
PTMA403033N2AZ	ACTIVE	Surface Mount Module	BET	6	30	Pb-Free (RoHS)	SNAGCU	Level-3-260C-168 HR	<a href="#">Request Free Samples</a>
PTMA403033N2AZT	ACTIVE	Surface Mount Module	BET	6	250	Pb-Free (RoHS)	SNAGCU	Level-3-260C-168 HR	<a href="#">Purchase Samples</a>
PTMA403033P1AD	ACTIVE	Through-Hole Module	EEP	5	30	Pb-Free (RoHS)	SN	N / A for Pkg Type	<a href="#">Request Free Samples</a>
PTMA403033P1AS	ACTIVE	Surface Mount Module	EET	5	30	TBD	SNPB	Level-1-235C-UNLIM/ Level-3-260C-168HRS	<a href="#">Purchase Samples</a>
PTMA403033P1AST	ACTIVE	Surface Mount Module	EET	5	250	TBD	SNPB	Level-1-235C-UNLIM/ Level-3-260C-168HRS	<a href="#">Purchase Samples</a>
PTMA403033P1AZ	ACTIVE	Surface Mount Module	BET	5	30	Pb-Free (RoHS)	SNAGCU	Level-3-260C-168 HR	<a href="#">Purchase Samples</a>
PTMA403033P1AZT	ACTIVE	Surface Mount Module	BET	5	250	Pb-Free (RoHS)	SNAGCU	Level-3-260C-168 HR	<a href="#">Purchase Samples</a>
PTMA403033P2AD	ACTIVE	Through-Hole Module	EEP	6	30	Pb-Free (RoHS)	SN	N / A for Pkg Type	<a href="#">Request Free Samples</a>
PTMA403033P2AS	ACTIVE	Surface Mount Module	EET	6	30	TBD	SNPB	Level-1-235C-UNLIM/ Level-3-260C-168HRS	<a href="#">Purchase Samples</a>
PTMA403033P2AST	ACTIVE	Surface Mount Module	EET	6	250	TBD	SNPB	Level-1-235C-UNLIM/ Level-3-260C-168HRS	<a href="#">Purchase Samples</a>
PTMA403033P2AZ	ACTIVE	Surface Mount Module	BET	6	30	Pb-Free (RoHS)	SNAGCU	Level-3-260C-168 HR	<a href="#">Request Free Samples</a>
PTMA403033P2AZT	ACTIVE	Surface Mount Module	BET	6	250	Pb-Free (RoHS)	SNAGCU	Level-3-260C-168 HR	<a href="#">Purchase Samples</a>

<sup>(1)</sup> The marketing status values are defined as follows:

**ACTIVE:** Product device recommended for new designs.

**LIFEBUY:** TI has announced that the device will be discontinued, and a lifetime-buy period is in effect.

**NRND:** Not recommended for new designs. Device is in production to support existing customers, but TI does not recommend using this part in a new design.

---

**PREVIEW:** Device has been announced but is not in production. Samples may or may not be available.

**OBSELETE:** TI has discontinued the production of the device.

<sup>(2)</sup> Eco Plan - The planned eco-friendly classification: Pb-Free (RoHS), Pb-Free (RoHS Exempt), or Green (RoHS & no Sb/Br) - please check <http://www.ti.com/productcontent> for the latest availability information and additional product content details.

**TBD:** The Pb-Free/Green conversion plan has not been defined.

**Pb-Free (RoHS):** TI's terms "Lead-Free" or "Pb-Free" mean semiconductor products that are compatible with the current RoHS requirements for all 6 substances, including the requirement that lead not exceed 0.1% by weight in homogeneous materials. Where designed to be soldered at high temperatures, TI Pb-Free products are suitable for use in specified lead-free processes.

**Pb-Free (RoHS Exempt):** This component has a RoHS exemption for either 1) lead-based flip-chip solder bumps used between the die and package, or 2) lead-based die adhesive used between the die and leadframe. The component is otherwise considered Pb-Free (RoHS compatible) as defined above.

**Green (RoHS & no Sb/Br):** TI defines "Green" to mean Pb-Free (RoHS compatible), and free of Bromine (Br) and Antimony (Sb) based flame retardants (Br or Sb do not exceed 0.1% by weight in homogeneous material)

<sup>(3)</sup> MSL, Peak Temp. -- The Moisture Sensitivity Level rating according to the JEDEC industry standard classifications, and peak solder temperature.

**Important Information and Disclaimer:** The information provided on this page represents TI's knowledge and belief as of the date that it is provided. TI bases its knowledge and belief on information provided by third parties, and makes no representation or warranty as to the accuracy of such information. Efforts are underway to better integrate information from third parties. TI has taken and continues to take reasonable steps to provide representative and accurate information but may not have conducted destructive testing or chemical analysis on incoming materials and chemicals. TI and TI suppliers consider certain information to be proprietary, and thus CAS numbers and other limited information may not be available for release.

In no event shall TI's liability arising out of such information exceed the total purchase price of the TI part(s) at issue in this document sold by TI to Customer on an annual basis.

EEP (R-PDSS-T6)

DOUBLE SIDED MODULE

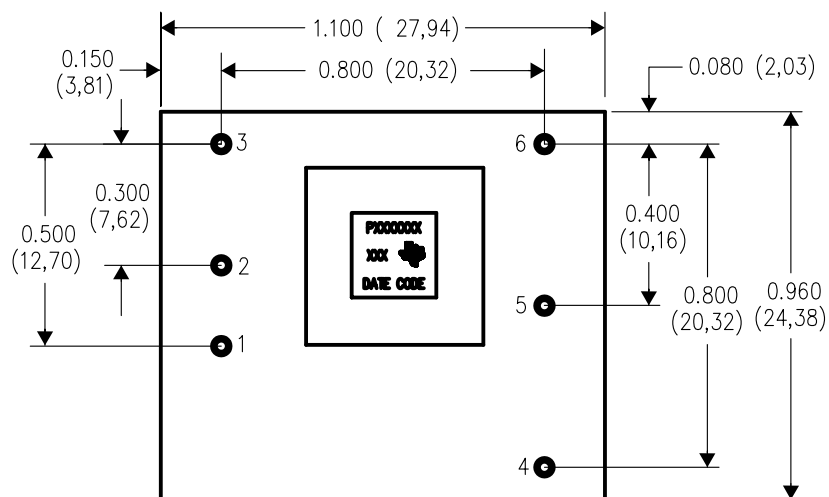

TOP VIEW

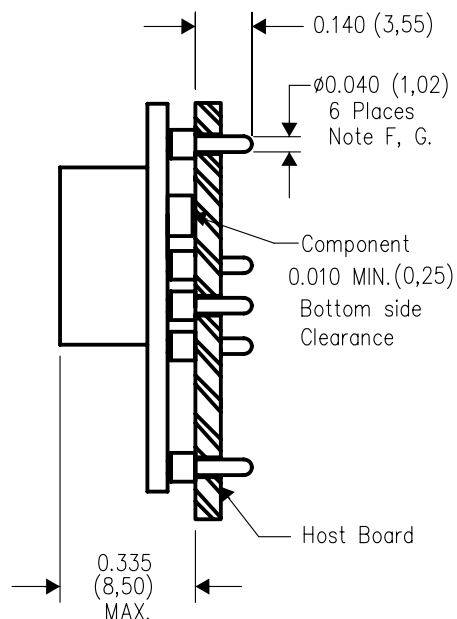

SIDE VIEW

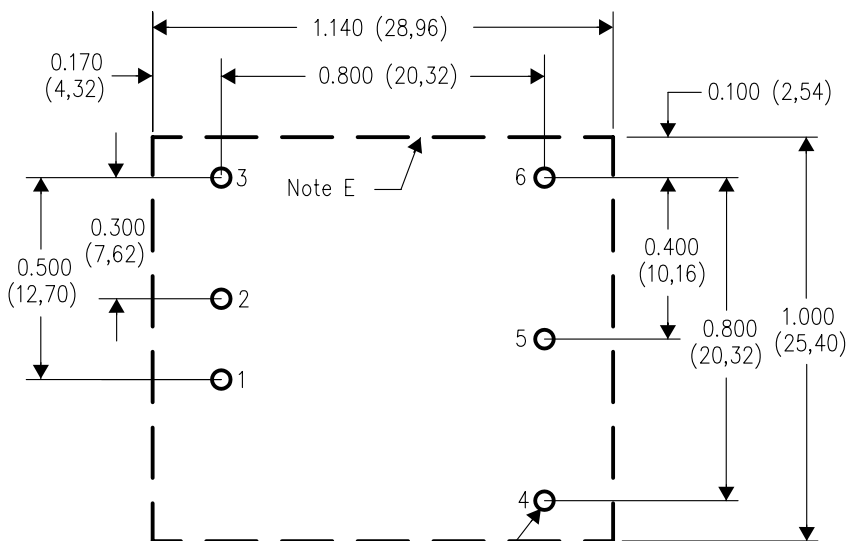

PC LAYOUT

∅0.055 (1,40) Min. 6 Places  
Plated through holes.

4207367-4/C 02/06

- NOTES:
- A. All linear dimensions are in inches (mm).
  - B. This drawing is subject to change without notice.
  - C. 2 place decimals are  $\pm 0.030$  ( $\pm 0,76$ mm).
  - D. 3 place decimals are  $\pm 0.010$  ( $\pm 0,25$ mm).
  - E. Recommended keep out area for user components.

- F. Pins are 0.040" (1,02) diameter with 0.070" (1,78) diameter standoff shoulder.
- G. All pins: Material - Copper Alloy  
Finish - Tin (100%) over Nickel plate

EET (R-PDSS-B6)

DOUBLE SIDED MODULE

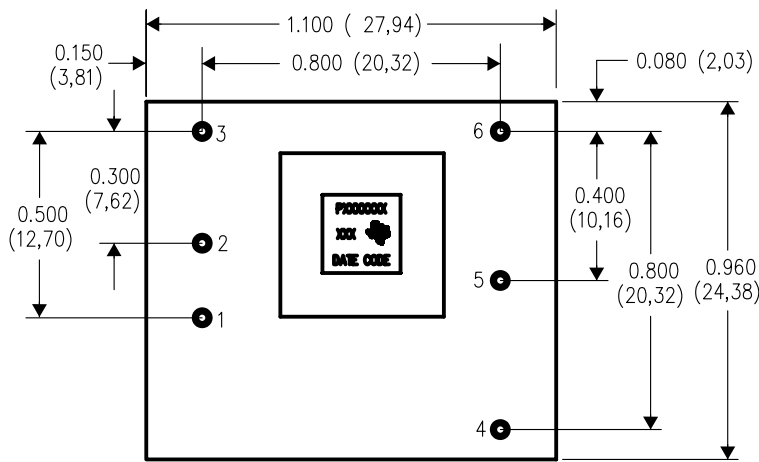

TOP VIEW

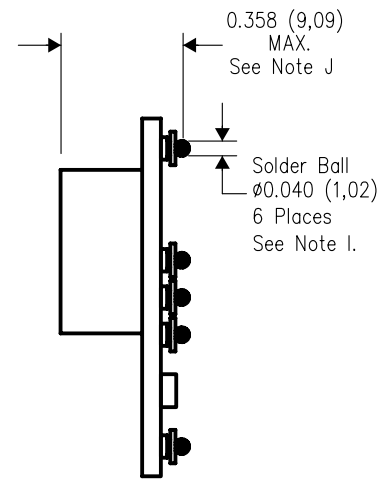

SIDE VIEW

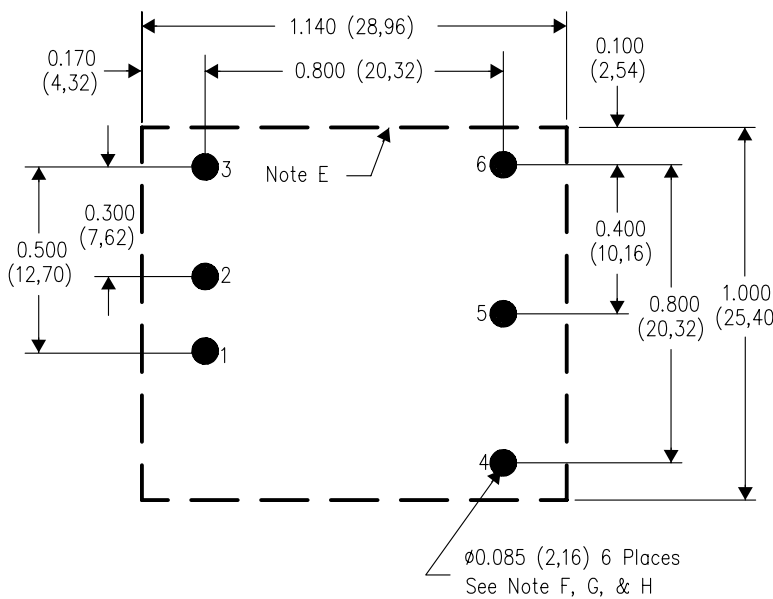

PC LAYOUT

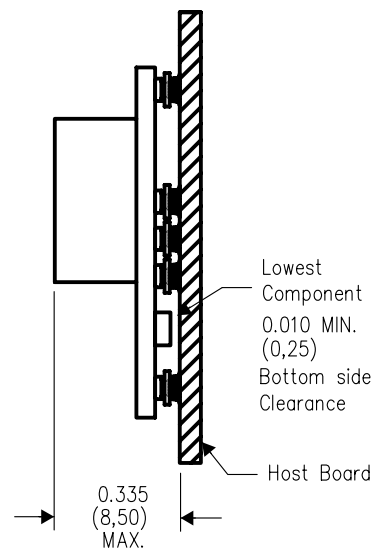

4207368-4/C 02/06

- NOTES:
- A. All linear dimensions are in inches (mm).
  - B. This drawing is subject to change without notice.
  - C. 2 place decimals are  $\pm 0.030$  ( $\pm 0,76$ mm).
  - D. 3 place decimals are  $\pm 0.010$  ( $\pm 0,25$ mm).
  - E. Recommended keep out area for user components.
  - F. Power pin connection should utilize four or more vias to the interior power plane of 0.025 (0,63) I.D. per input, ground and output pin (or the electrical equivalent).

- G. Paste screen opening: 0.080 (2,03) to 0.085 (2,16).  
Paste screen thickness: 0.006 (0,15).
- H. Pad type: Solder mask defined.
- I. All pins: Material - Copper Alloy  
Finish - Tin (100%) over Nickel plate  
Solder Ball - See product data sheet.
- J. Dimension prior to reflow solder.

EEP (R-PDSS-T4)

DOUBLE SIDED MODULE

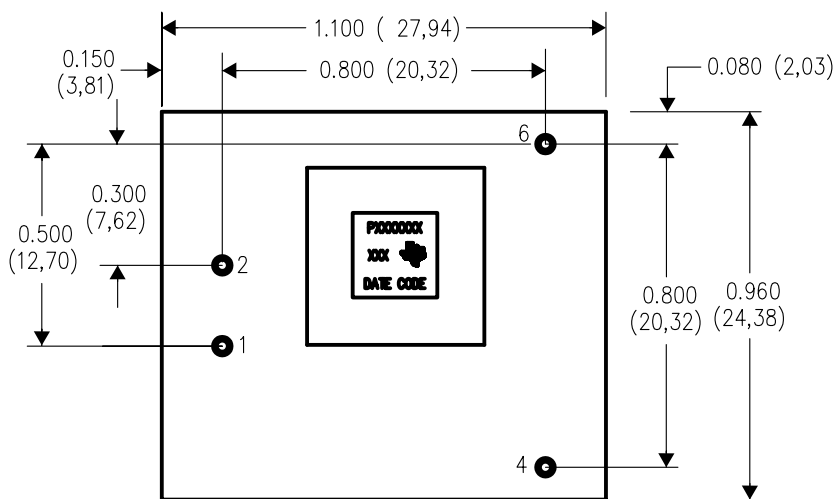

TOP VIEW

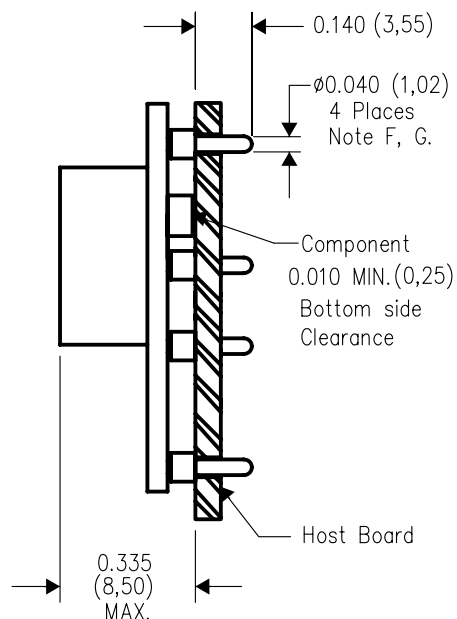

SIDE VIEW

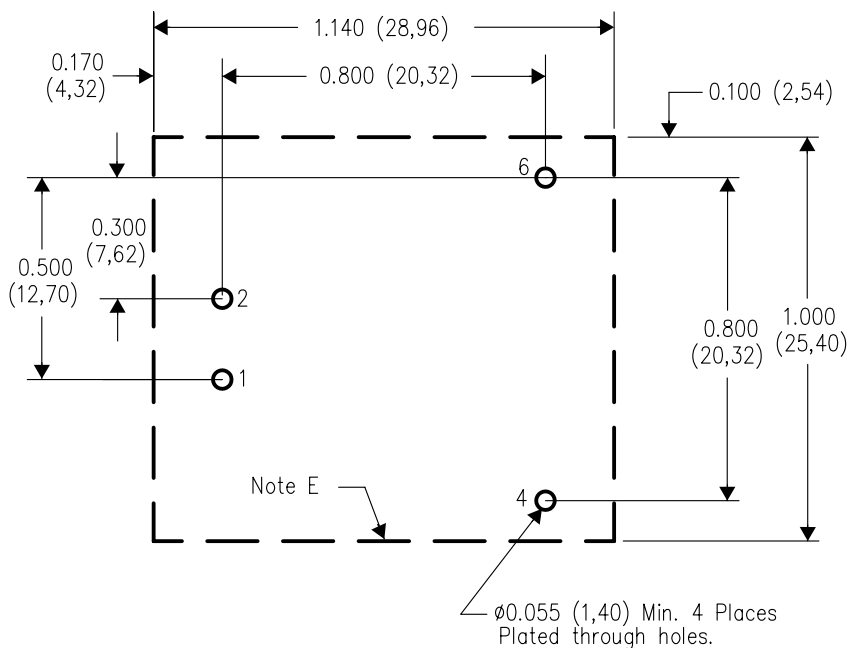

PC LAYOUT

4207367-2/C 02/06

- NOTES:
- A. All linear dimensions are in inches (mm).
  - B. This drawing is subject to change without notice.
  - C. 2 place decimals are  $\pm 0.030$  ( $\pm 0,76$ mm).
  - D. 3 place decimals are  $\pm 0.010$  ( $\pm 0,25$ mm).
  - E. Recommended keep out area for user components.

- F. Pins are 0.040" (1,02) diameter with 0.070" (1,78) diameter standoff shoulder.
- G. All pins: Material - Copper Alloy  
Finish - Tin (100%) over Nickel plate

EEP (R-PDSS-T5)

DOUBLE SIDED MODULE

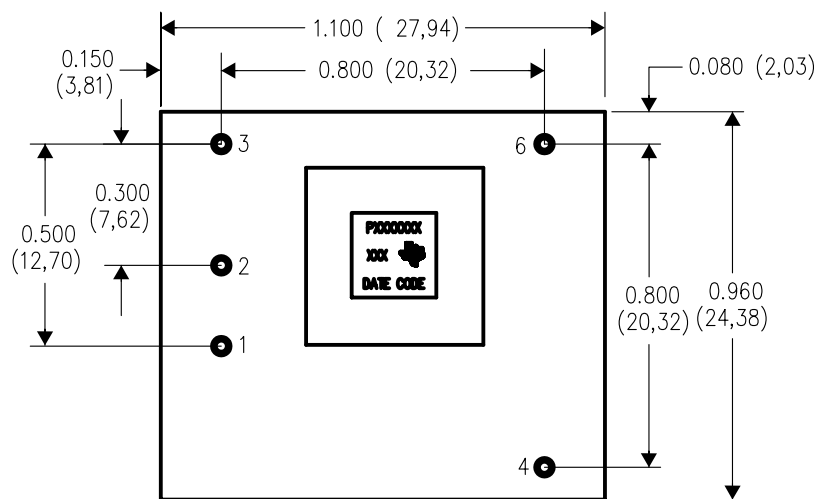

TOP VIEW

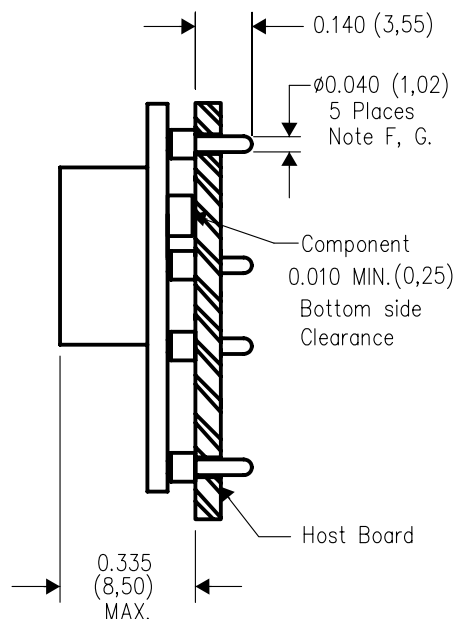

SIDE VIEW

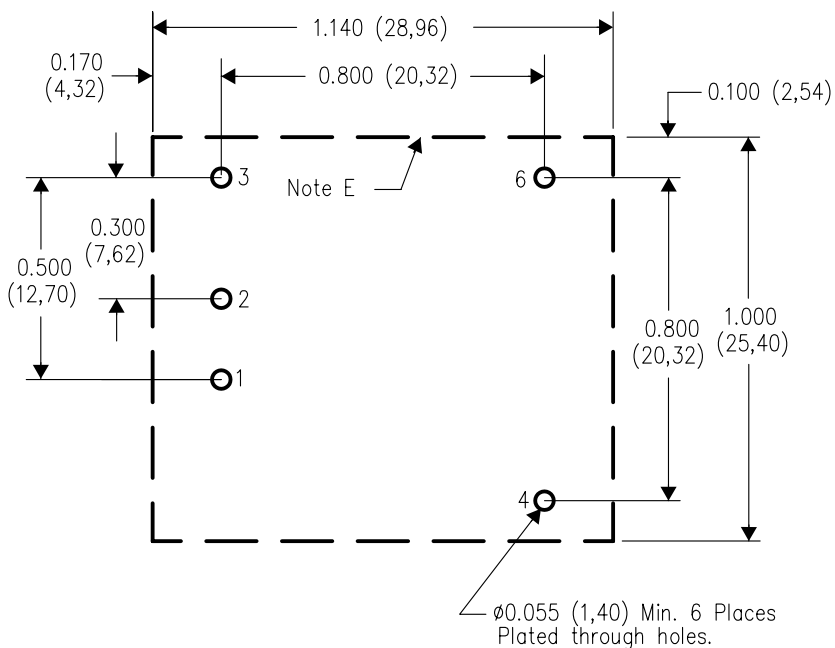

PC LAYOUT

4207367-3/C 02/06

- NOTES:
- A. All linear dimensions are in inches (mm).
  - B. This drawing is subject to change without notice.
  - C. 2 place decimals are  $\pm 0.030$  ( $\pm 0,76$ mm).
  - D. 3 place decimals are  $\pm 0.010$  ( $\pm 0,25$ mm).
  - E. Recommended keep out area for user components.

- F. Pins are 0.040" (1,02) diameter with 0.070" (1,78) diameter standoff shoulder.
- G. All pins: Material - Copper Alloy  
Finish - Tin (100%) over Nickel plate

EET (R-PDSS-B5)

DOUBLE SIDED MODULE

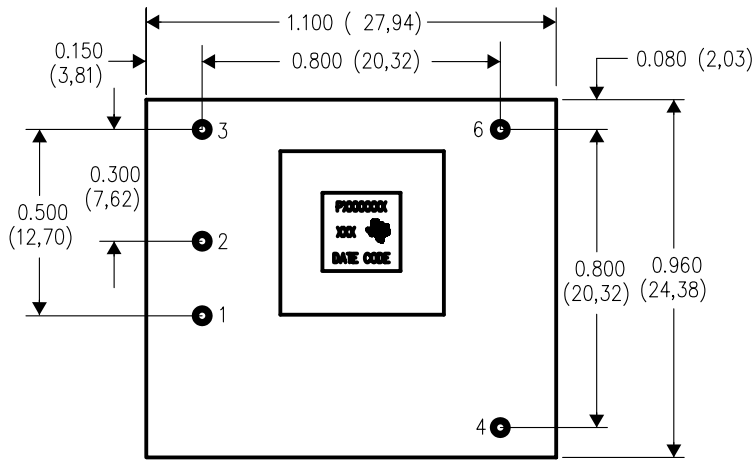

TOP VIEW

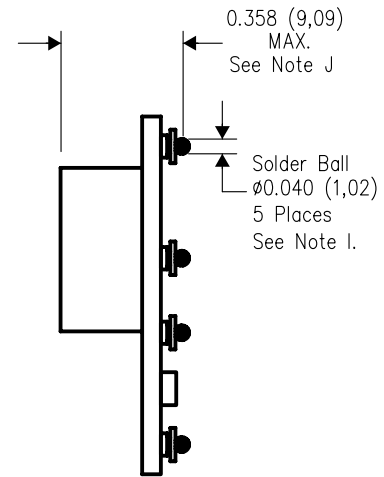

SIDE VIEW

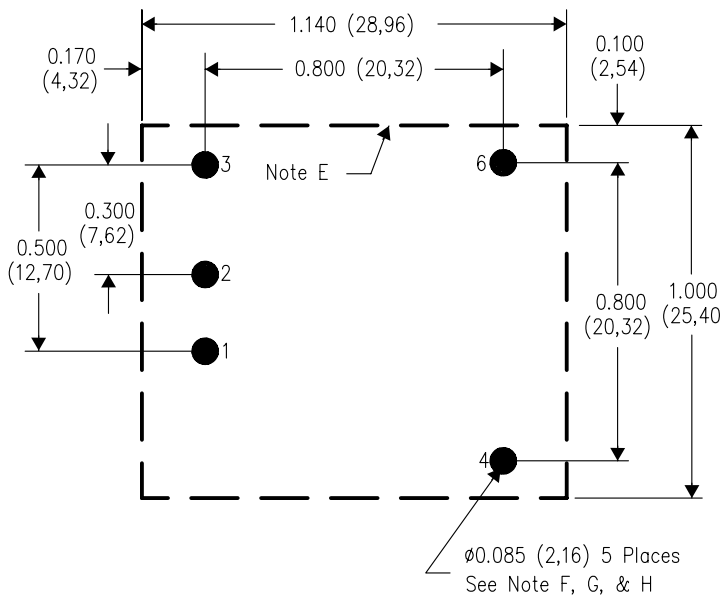

PC LAYOUT

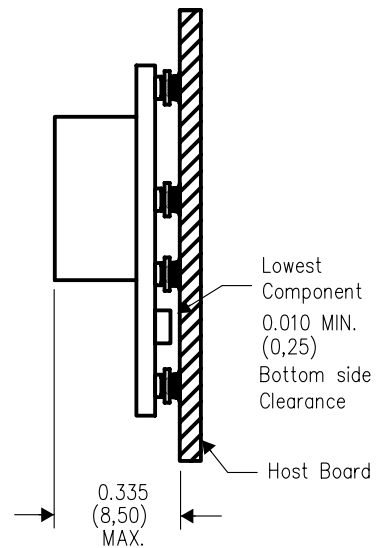

4207368-3/C 02/06

- NOTES:
- A. All linear dimensions are in inches (mm).
  - B. This drawing is subject to change without notice.
  - C. 2 place decimals are  $\pm 0.030$  ( $\pm 0,76$ mm).
  - D. 3 place decimals are  $\pm 0.010$  ( $\pm 0,25$ mm).
  - E. Recommended keep out area for user components.
  - F. Power pin connection should utilize four or more vias to the interior power plane of 0.025 (0,63) I.D. per input, ground and output pin (or the electrical equivalent).

- G. Paste screen opening: 0.080 (2,03) to 0.085 (2,16).  
Paste screen thickness: 0.006 (0,15).
- H. Pad type: Solder mask defined.
- I. All pins: Material - Copper Alloy  
Finish - Tin (100%) over Nickel plate  
Solder Ball - See product data sheet.
- J. Dimension prior to reflow solder.

EET (R-PDSS-B4)

DOUBLE SIDED MODULE

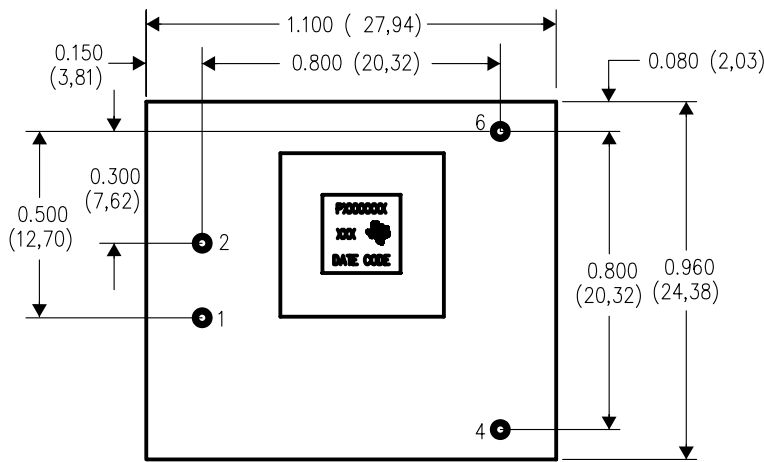

TOP VIEW

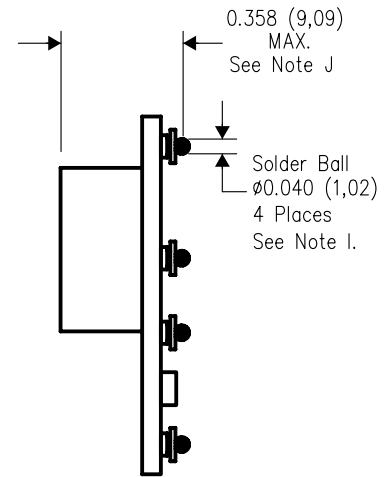

SIDE VIEW

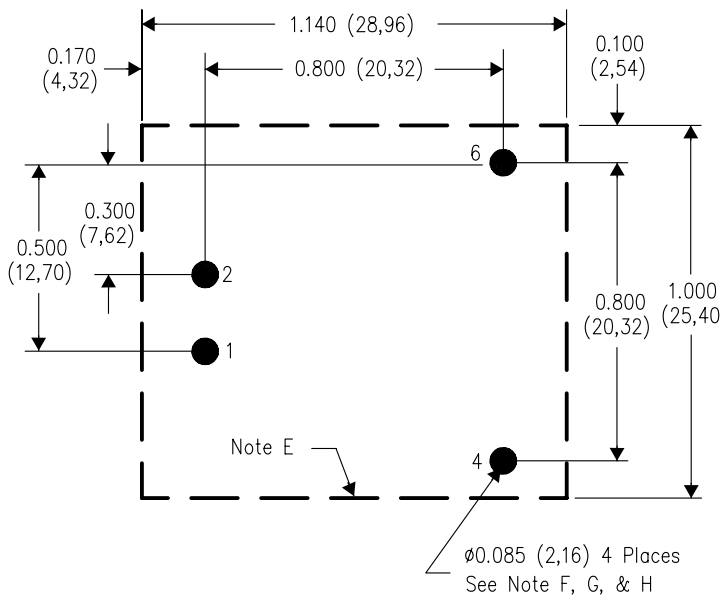

PC LAYOUT

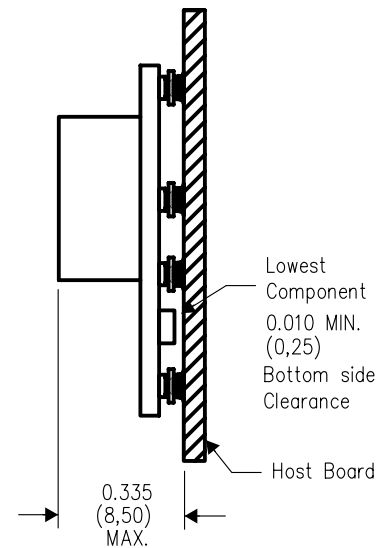

4207368-2/C 02/06

- NOTES:
- A. All linear dimensions are in inches (mm).
  - B. This drawing is subject to change without notice.
  - C. 2 place decimals are  $\pm 0.030$  ( $\pm 0,76$ mm).
  - D. 3 place decimals are  $\pm 0.010$  ( $\pm 0,25$ mm).
  - E. Recommended keep out area for user components.
  - F. Power pin connection should utilize four or more vias to the interior power plane of 0.025 (0,63) I.D. per input, ground and output pin (or the electrical equivalent).

- G. Paste screen opening: 0.080 (2,03) to 0.085 (2,16).  
Paste screen thickness: 0.006 (0,15).
- H. Pad type: Solder mask defined.
- I. All pins: Material - Copper Alloy  
Finish - Tin (100%) over Nickel plate  
Solder Ball - See product data sheet.
- J. Dimension prior to reflow solder.

EEV (R-PDSS-T5)

DOUBLE SIDED MODULE

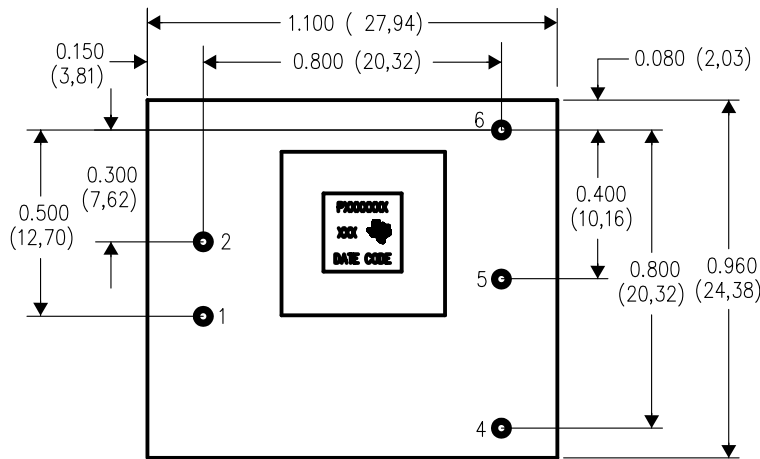

TOP VIEW

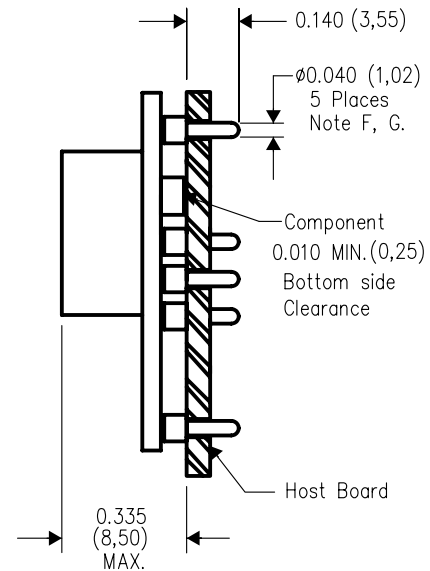

SIDE VIEW

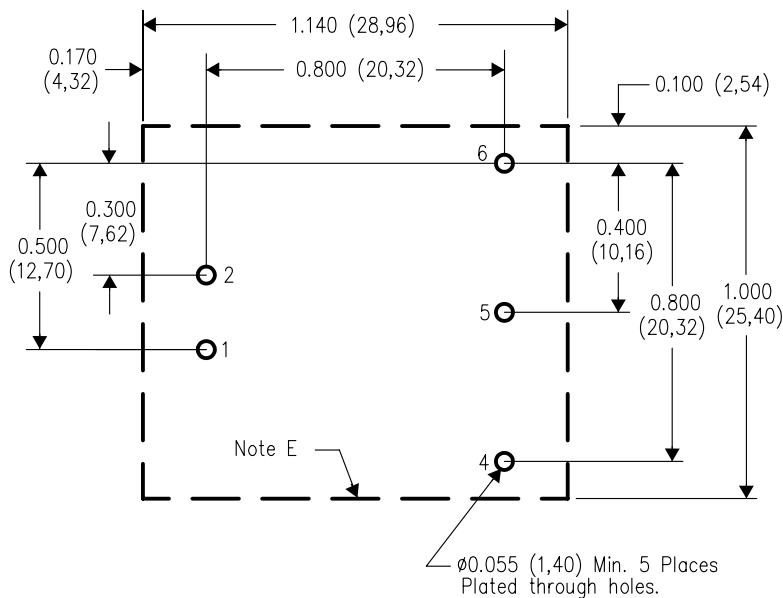

PC LAYOUT

4207709/A 02/06

- NOTES:
- A. All linear dimensions are in inches (mm).
  - B. This drawing is subject to change without notice.
  - C. 2 place decimals are  $\pm 0.030$  ( $\pm 0,76$ mm).
  - D. 3 place decimals are  $\pm 0.010$  ( $\pm 0,25$ mm).
  - E. Recommended keep out area for user components.

- F. Pins are 0.040" (1,02) diameter with 0.070" (1,78) diameter standoff shoulder.
- G. All pins: Material - Copper Alloy  
Finish - Tin (100%) over Nickel plate

EEW (R-PDSS-B5)

DOUBLE SIDED MODULE

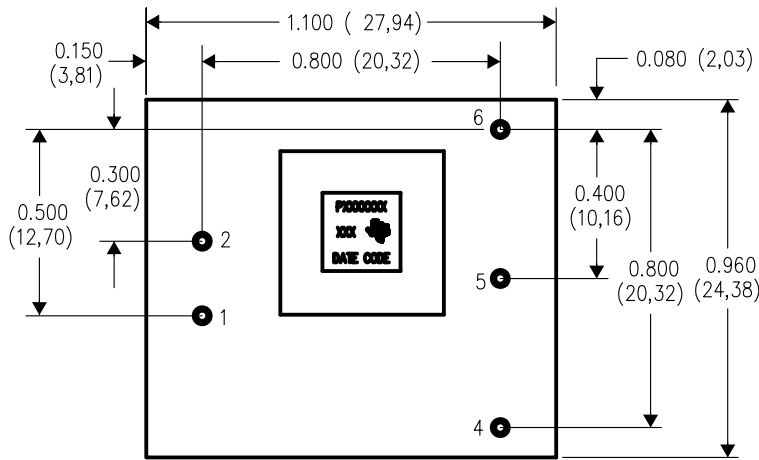

TOP VIEW

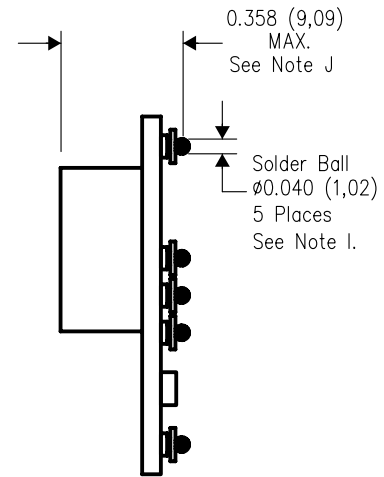

SIDE VIEW

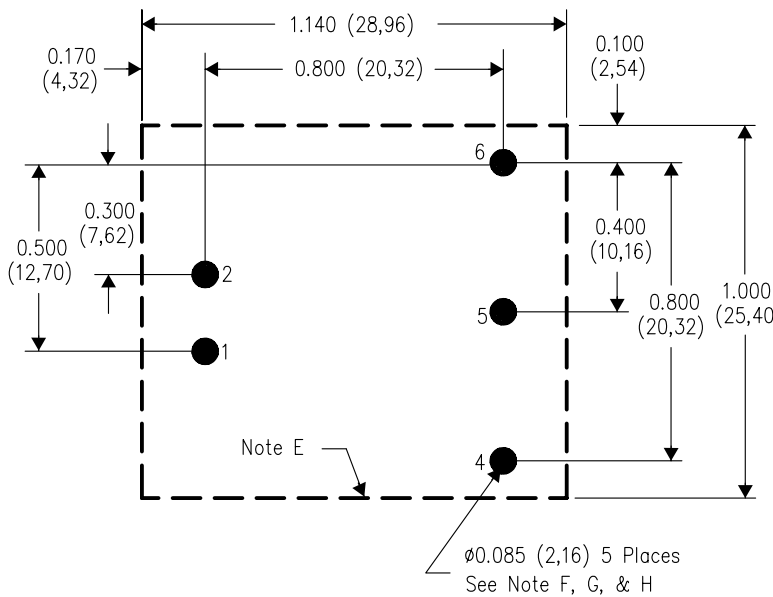

PC LAYOUT

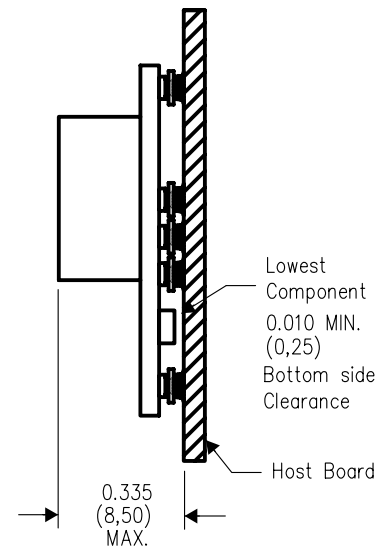

4207710/A 02/06

- NOTES:
- A. All linear dimensions are in inches (mm).
  - B. This drawing is subject to change without notice.
  - C. 2 place decimals are  $\pm 0.030$  ( $\pm 0,76$ mm).
  - D. 3 place decimals are  $\pm 0.010$  ( $\pm 0,25$ mm).
  - E. Recommended keep out area for user components.
  - F. Power pin connection should utilize four or more vias to the interior power plane of 0.025 (0,63) I.D. per input, ground and output pin (or the electrical equivalent).

- G. Paste screen opening: 0.080 (2,03) to 0.085 (2,16).  
 Paste screen thickness: 0.006 (0,15).
- H. Pad type: Solder mask defined.
- I. All pins: Material - Copper Alloy  
 Finish - Tin (100%) over Nickel plate  
 Solder Ball - See product data sheet.
- J. Dimension prior to reflow solder.

BET (R-PDSS-B4)

DOUBLE SIDED MODULE

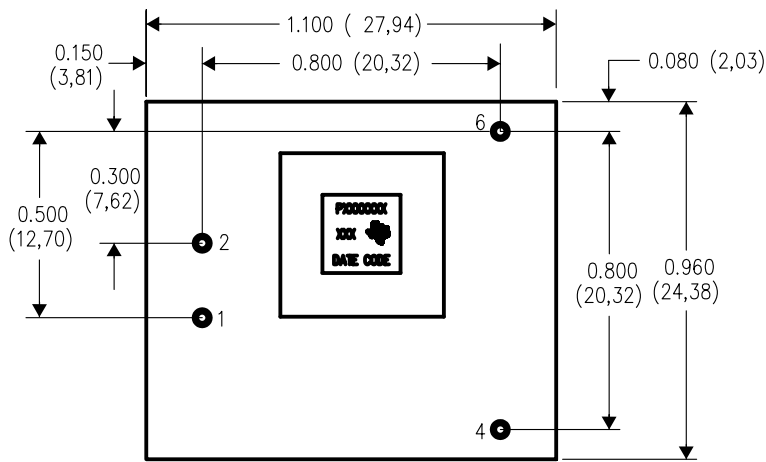

TOP VIEW

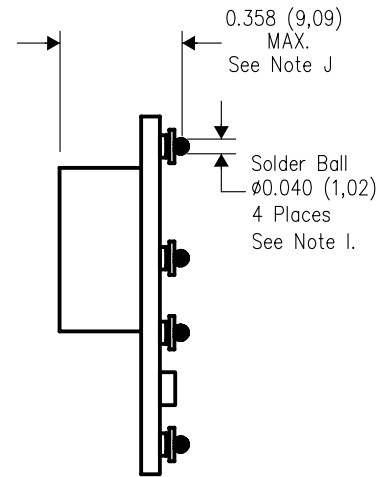

SIDE VIEW

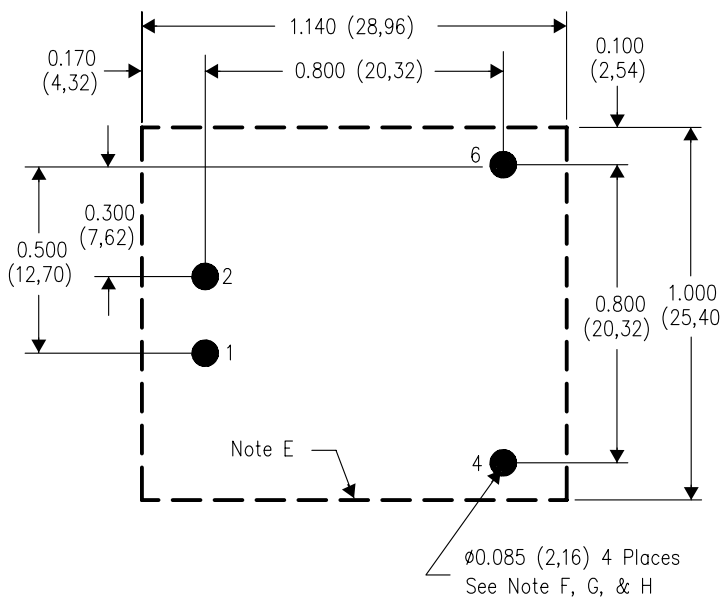

PC LAYOUT

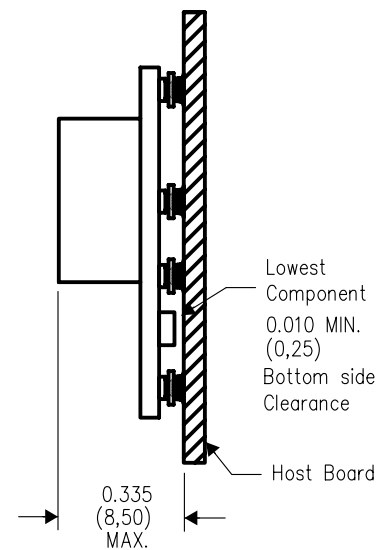

4207711-2/B 02/06

- NOTES:
- A. All linear dimensions are in inches (mm).
  - B. This drawing is subject to change without notice.
  - C. 2 place decimals are  $\pm 0.030$  ( $\pm 0,76$ mm).
  - D. 3 place decimals are  $\pm 0.010$  ( $\pm 0,25$ mm).
  - E. Recommended keep out area for user components.
  - F. Power pin connection should utilize four or more vias to the interior power plane of 0.025 (0,63) I.D. per input, ground and output pin (or the electrical equivalent).

- G. Paste screen opening: 0.080 (2,03) to 0.085 (2,16).  
Paste screen thickness: 0.006 (0,15).
- H. Pad type: Solder mask defined.
- I. This is a lead-free solder ball design.  
Finish: Tin (100%) over Nickel plate  
Solder ball: 96.5 Sn/3.0 Ag/0.5 Cu
- J. Dimension prior to reflow solder.

BET (R-PDSS-B5)

DOUBLE SIDED MODULE

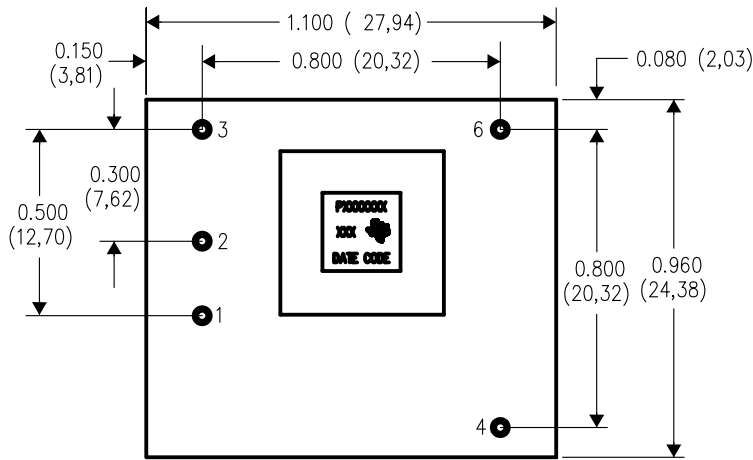

TOP VIEW

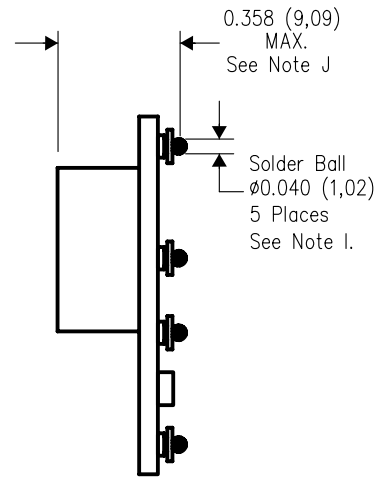

SIDE VIEW

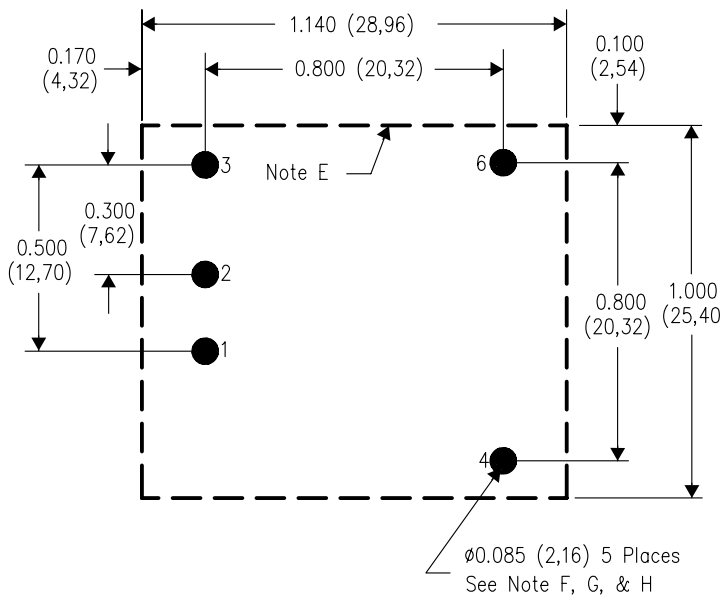

PC LAYOUT

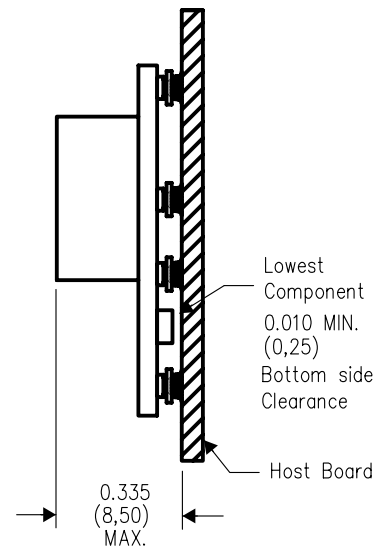

4207711-3/B 02/06

- NOTES:
- A. All linear dimensions are in inches (mm).
  - B. This drawing is subject to change without notice.
  - C. 2 place decimals are  $\pm 0.030$  ( $\pm 0,76$ mm).
  - D. 3 place decimals are  $\pm 0.010$  ( $\pm 0,25$ mm).
  - E. Recommended keep out area for user components.
  - F. Power pin connection should utilize four or more vias to the interior power plane of 0.025 (0,63) I.D. per input, ground and output pin (or the electrical equivalent).

- G. Paste screen opening: 0.080 (2,03) to 0.085 (2,16).  
Paste screen thickness: 0.006 (0,15).
- H. Pad type: Solder mask defined.
- I. This is a lead-free solder ball design.  
Finish: Tin (100%) over Nickel plate  
Solder ball: 96.5 Sn/3.0 Ag/0.5 Cu
- J. Dimension prior to reflow solder.

BET (R-PDSS-B6)

DOUBLE SIDED MODULE

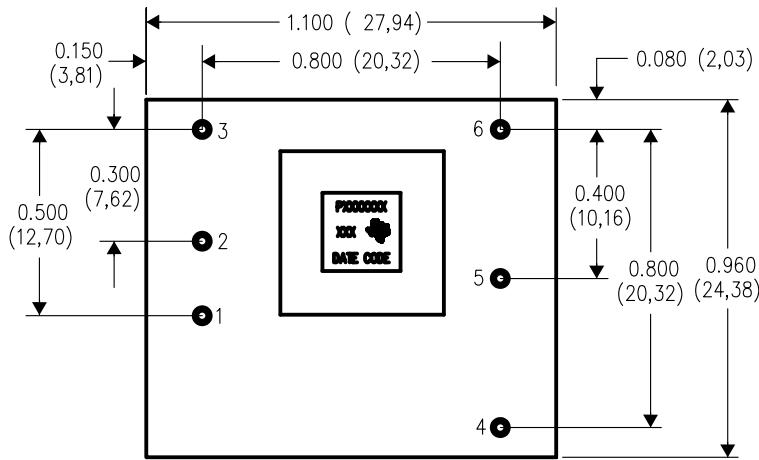

TOP VIEW

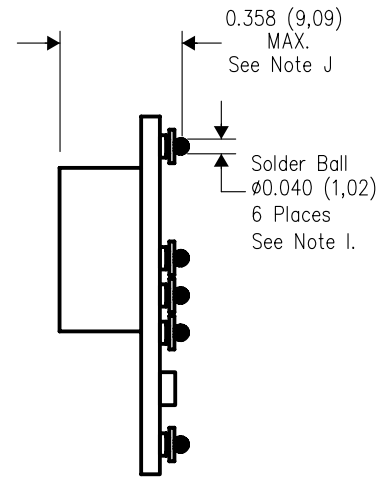

SIDE VIEW

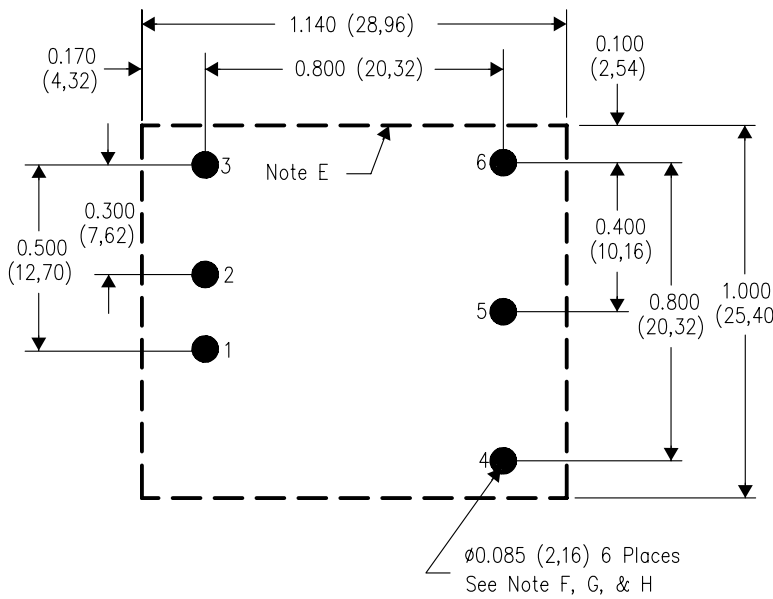

PC LAYOUT

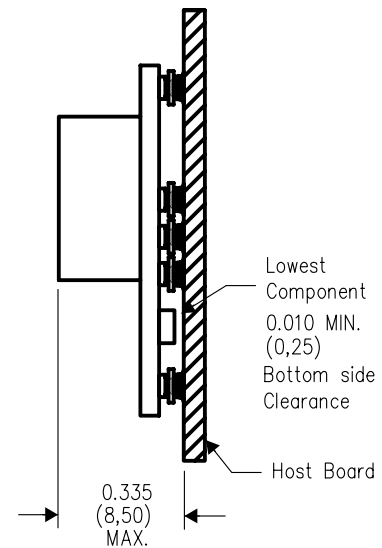

4207711-4/B 02/06

- NOTES:
- A. All linear dimensions are in inches (mm).
  - B. This drawing is subject to change without notice.
  - C. 2 place decimals are  $\pm 0.030$  ( $\pm 0,76$ mm).
  - D. 3 place decimals are  $\pm 0.010$  ( $\pm 0,25$ mm).
  - E. Recommended keep out area for user components.
  - F. Power pin connection should utilize four or more vias to the interior power plane of 0.025 (0,63) I.D. per input, ground and output pin (or the electrical equivalent).

- G. Paste screen opening: 0.080 (2,03) to 0.085 (2,16).  
Paste screen thickness: 0.006 (0,15).
- H. Pad type: Solder mask defined.
- I. This is a lead-free solder ball design.  
Finish: Tin (100%) over Nickel plate  
Solder ball: 96.5 Sn/3.0 Ag/0.5 Cu
- J. Dimension prior to reflow solder.

BEW (R-PDSS-B5)

DOUBLE SIDED MODULE

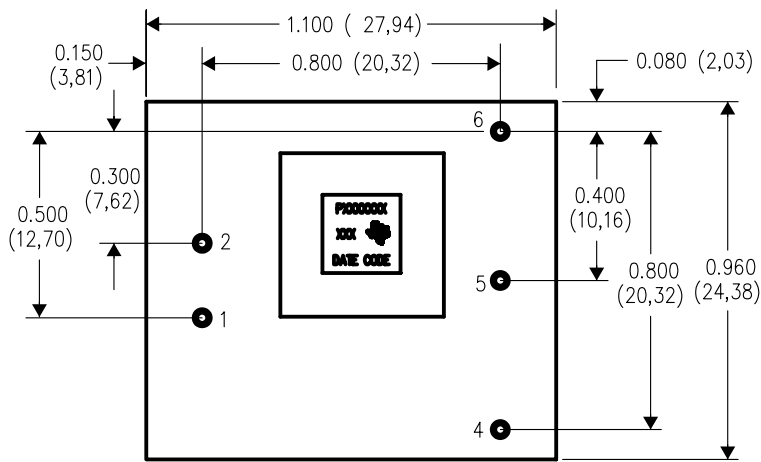

TOP VIEW

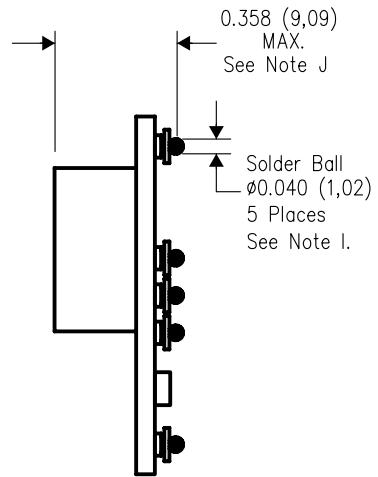

SIDE VIEW

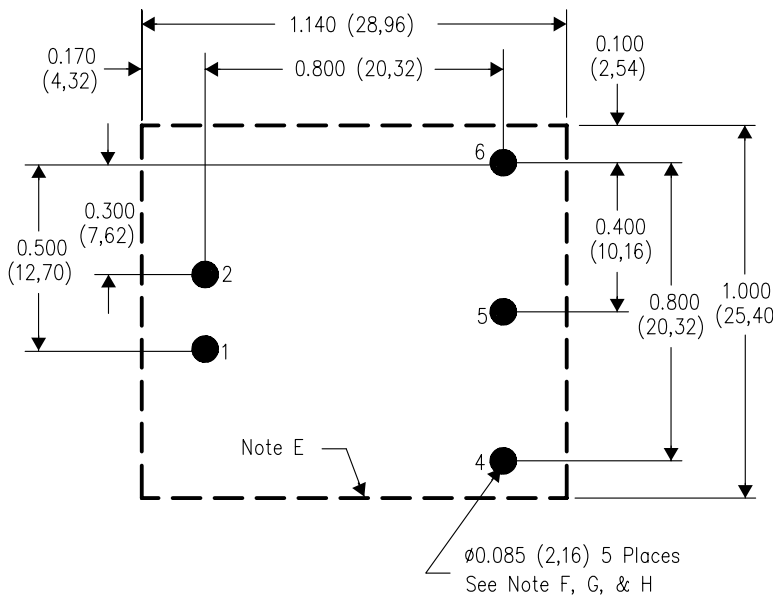

PC LAYOUT

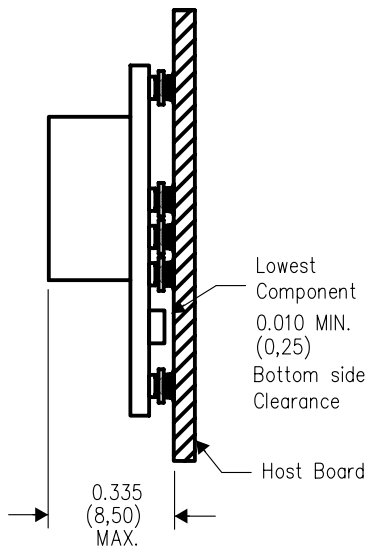

4207712/B 02/06

- NOTES:
- A. All linear dimensions are in inches (mm).
  - B. This drawing is subject to change without notice.
  - C. 2 place decimals are  $\pm 0.030$  ( $\pm 0,76$ mm).
  - D. 3 place decimals are  $\pm 0.010$  ( $\pm 0,25$ mm).
  - E. Recommended keep out area for user components.
  - F. Power pin connection should utilize four or more vias to the interior power plane of 0.025 (0,63) I.D. per input, ground and output pin (or the electrical equivalent).

- G. Paste screen opening: 0.080 (2,03) to 0.085 (2,16).  
Paste screen thickness: 0.006 (0,15).
- H. Pad type: Solder mask defined.
- I. This is a lead-free solder ball design.  
Finish: Tin (100%) over Nickel plate  
Solder ball: 96.5 Sn/3.0 Ag/0.5 Cu
- J. Dimension prior to reflow solder.

## IMPORTANT NOTICE

Texas Instruments Incorporated and its subsidiaries (TI) reserve the right to make corrections, modifications, enhancements, improvements, and other changes to its products and services at any time and to discontinue any product or service without notice. Customers should obtain the latest relevant information before placing orders and should verify that such information is current and complete. All products are sold subject to TI's terms and conditions of sale supplied at the time of order acknowledgment.

TI warrants performance of its hardware products to the specifications applicable at the time of sale in accordance with TI's standard warranty. Testing and other quality control techniques are used to the extent TI deems necessary to support this warranty. Except where mandated by government requirements, testing of all parameters of each product is not necessarily performed.

TI assumes no liability for applications assistance or customer product design. Customers are responsible for their products and applications using TI components. To minimize the risks associated with customer products and applications, customers should provide adequate design and operating safeguards.

TI does not warrant or represent that any license, either express or implied, is granted under any TI patent right, copyright, mask work right, or other TI intellectual property right relating to any combination, machine, or process in which TI products or services are used. Information published by TI regarding third-party products or services does not constitute a license from TI to use such products or services or a warranty or endorsement thereof. Use of such information may require a license from a third party under the patents or other intellectual property of the third party, or a license from TI under the patents or other intellectual property of TI.

Reproduction of TI information in TI data books or data sheets is permissible only if reproduction is without alteration and is accompanied by all associated warranties, conditions, limitations, and notices. Reproduction of this information with alteration is an unfair and deceptive business practice. TI is not responsible or liable for such altered documentation. Information of third parties may be subject to additional restrictions.

Resale of TI products or services with statements different from or beyond the parameters stated by TI for that product or service voids all express and any implied warranties for the associated TI product or service and is an unfair and deceptive business practice. TI is not responsible or liable for any such statements.

TI products are not authorized for use in safety-critical applications (such as life support) where a failure of the TI product would reasonably be expected to cause severe personal injury or death, unless officers of the parties have executed an agreement specifically governing such use. Buyers represent that they have all necessary expertise in the safety and regulatory ramifications of their applications, and acknowledge and agree that they are solely responsible for all legal, regulatory and safety-related requirements concerning their products and any use of TI products in such safety-critical applications, notwithstanding any applications-related information or support that may be provided by TI. Further, Buyers must fully indemnify TI and its representatives against any damages arising out of the use of TI products in such safety-critical applications.

TI products are neither designed nor intended for use in military/aerospace applications or environments unless the TI products are specifically designated by TI as military-grade or "enhanced plastic." Only products designated by TI as military-grade meet military specifications. Buyers acknowledge and agree that any such use of TI products which TI has not designated as military-grade is solely at the Buyer's risk, and that they are solely responsible for compliance with all legal and regulatory requirements in connection with such use.

TI products are neither designed nor intended for use in automotive applications or environments unless the specific TI products are designated by TI as compliant with ISO/TS 16949 requirements. Buyers acknowledge and agree that, if they use any non-designated products in automotive applications, TI will not be responsible for any failure to meet such requirements.

Following are URLs where you can obtain information on other Texas Instruments products and application solutions:

<b>Products</b>		<b>Applications</b>	
Amplifiers	<a href="http://amplifier.ti.com">amplifier.ti.com</a>	Audio	<a href="http://www.ti.com/audio">www.ti.com/audio</a>
Data Converters	<a href="http://dataconverter.ti.com">dataconverter.ti.com</a>	Automotive	<a href="http://www.ti.com/automotive">www.ti.com/automotive</a>
DLP® Products	<a href="http://www.dlp.com">www.dlp.com</a>	Communications and Telecom	<a href="http://www.ti.com/communications">www.ti.com/communications</a>
DSP	<a href="http://dsp.ti.com">dsp.ti.com</a>	Computers and Peripherals	<a href="http://www.ti.com/computers">www.ti.com/computers</a>
Clocks and Timers	<a href="http://www.ti.com/clocks">www.ti.com/clocks</a>	Consumer Electronics	<a href="http://www.ti.com/consumer-apps">www.ti.com/consumer-apps</a>
Interface	<a href="http://interface.ti.com">interface.ti.com</a>	Energy	<a href="http://www.ti.com/energy">www.ti.com/energy</a>
Logic	<a href="http://logic.ti.com">logic.ti.com</a>	Industrial	<a href="http://www.ti.com/industrial">www.ti.com/industrial</a>
Power Mgmt	<a href="http://power.ti.com">power.ti.com</a>	Medical	<a href="http://www.ti.com/medical">www.ti.com/medical</a>
Microcontrollers	<a href="http://microcontroller.ti.com">microcontroller.ti.com</a>	Security	<a href="http://www.ti.com/security">www.ti.com/security</a>
RFID	<a href="http://www.ti-rfid.com">www.ti-rfid.com</a>	Space, Avionics & Defense	<a href="http://www.ti.com/space-avionics-defense">www.ti.com/space-avionics-defense</a>
RF/IF and ZigBee® Solutions	<a href="http://www.ti.com/lprf">www.ti.com/lprf</a>	Video and Imaging	<a href="http://www.ti.com/video">www.ti.com/video</a>
		Wireless	<a href="http://www.ti.com/wireless-apps">www.ti.com/wireless-apps</a>

Mailing Address: Texas Instruments, Post Office Box 655303, Dallas, Texas 75265  
Copyright © 2010, Texas Instruments Incorporated