



### Features

- Dual Outputs  
(See Ordering Information)
- Ideal Power Source for DSPs
- 12V Input
- Outputs Adjustable
- Remote Sensing ( $V_{O1}$  &  $V_{O2}$ )
- Standby Function
- Soft-Start
- Internal Sequencing
- Short Circuit Protection
- 23-pin Space-Saving Package
- Solderable Copper Case

### Description

The PT6980 Excalibur™ series of power modules are dual output integrated switching regulators (ISRs) specifically designed to power mixed signal ICs. Operating from a 12-V input bus, the dual output provides power for both the digital I/O logic and a DSP core from a single module. Both output voltages are internally sequenced during power-up and power-down to comply with the requirements of the latest DSP chips. Each output is independently adjustable or can be set to at least one alternative bus voltage with a simple pin-strap. The modules are made available in a space-saving solderable case. The features include output current limit and short-circuit protection.

### Ordering Information

- PT6981□ = +2.5/1.8 Volts
- PT6982□ = +3.3/2.5 Volts
- PT6983□ = +3.3/1.8 Volts
- PT6984□ = +3.3/1.2 Volts
- PT6985□ = +2.5/1.2 Volts

### PT Series Suffix (PT1234x)

Case/Pin Configuration	Order Suffix	Package Code
Vertical	<b>N</b>	(ELF)
Horizontal	<b>A</b>	(ELG)
SMD	<b>C</b>	(ELH)

(Reference the applicable package code drawing for the dimensions and PC layout)

### Pin-Out Information

Pin	Function	Pin	Function
1	$V_{O1}$ Sense	13	$V_{O1}$
2	No Connect	14	$V_{O1}$
3	STBY	15	$V_{O1}$
4	$V_{in}$	16	$V_{O1}$ Adjust*
5	$V_{in}$	17	No Connect
6	$V_{in}$	18	$V_{O2}$
7	GND	19	$V_{O2}$
8	GND	20	$V_{O2}$
9	GND	21	$V_{O2}$
10	GND	22	$V_{O2}$ Sense
11	GND	23	$V_{O2}$ Adjust*
12	$V_{O1}$		

\*  $V_{O1}$  and  $V_{O2}$  can be pin-strapped to another voltage. See application note on output voltage adjustment.

### Standard Application

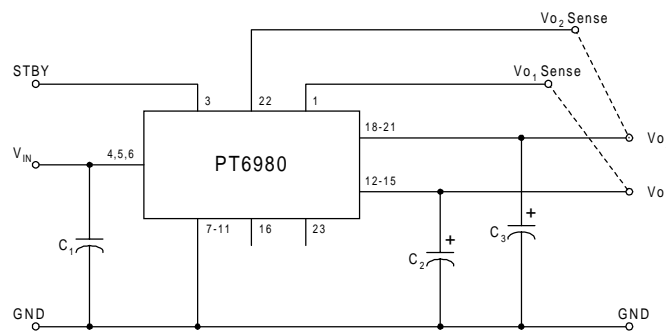

- C<sub>1</sub> = Req'd 560µF electrolytic
- C<sub>2</sub> = Req'd 330µF electrolytic
- C<sub>3</sub> = Optional 100µF electrolytic

### General Specifications (Unless otherwise stated, $T_a = 25^\circ\text{C}$ , $V_{in} = 12\text{V}$ )

Characteristic	Symbol	Conditions	PT6980 Series			Units
			Min	Typ	Max	
Short Circuit Current	$I_{sc}$	$Io_1 + Io_2$ combined	—	19	—	A
Switching Frequency	$f_o$	Over $V_{in}$ range	500	550	600	kHz
Standby (Pin 3)		Referenced to GND (pin 7)				
Input High Voltage	$V_{IH}$		—	—	Open <sup>(1)</sup>	V
Input Low Voltage	$V_{IL}$		-0.1	—	+0.4	
Input Low Current	$I_{IL}$		—	-0.5	—	mA
Standby Input Current	$I_{in, standby}$	pin 3 to GND	—	4	6	mA
External Output Capacitance	$C_2$ $C_3$		330 <sup>(2)</sup> 0	— —	15,000 <sup>(2)</sup> 330	$\mu\text{F}$
Maximum Operating Temperature Range	$T_a$	Over $V_{in}$ Range	-40 <sup>(3)</sup>	—	+85 <sup>(4)</sup>	$^\circ\text{C}$
Storage Temperature	$T_s$	—	-40	—	+125	$^\circ\text{C}$
Mechanical Shock		Per Mil-STD-883D, Method 2002.3 1 msec, 1/2 Sine, mounted	—	500	—	G's
Mechanical Vibration		Per Mil-STD-883D, Method 2007.2 20-2000 Hz, Soldered in a PC board	—	15	—	G's
Weight	—	Vertical/Horizontal	—	26	—	grams
Flammability	—	Meets UL 94V-O	—	—	—	—

- Notes:**
- (1) The Standby (pin 3) has an internal pull-up to  $V_{in}$ , and if it is left open circuit the module will operate when input power is applied. Refer to the application notes for interface considerations.
  - (2) The total combined ESR of all output capacitance at 100kHz must be (less than)  $<50\text{ m}\Omega$ .
  - (3) For operating temperatures below  $0^\circ\text{C}$ ,  $C_{in}$  and  $C_{out}$  must have stable characteristics. Use either tantalum or Oscon® capacitors.
  - (4) See Safe Operating Area curves for the specific output voltage combination, or contact the factory for the appropriate derating.

**Input/Output Capacitors:** The PT6980 series requires a 330 $\mu\text{F}$  electrolytic capacitor at both the input and output for proper operation (300 $\mu\text{F}$  for Oscon® or low ESR tantalum). In addition, the input capacitance must be rated for a minimum of 1.0Arms ripple current. For transient or dynamic load applications, additional capacitance may be required. Refer to the application notes for more information.

### Power-up Sequencing and $Vo_1/Vo_2$ Loading

#### Power-up Sequencing

The PT6980 series of regulators provide two output voltages,  $Vo_1$  and  $Vo_2$ . Each of the output voltage combinations offered by the PT6980 series provides power for both a low-voltage processor core, and the associated digital support circuitry. In addition, each output is internally sequenced during power-up and power-down to comply with the requirements of most DSP and  $\mu\text{P}$  IC's, and their accompanying chipsets. Figure 1 shows the typical waveforms of the output voltages,  $Vo_1$  and  $Vo_2$ , from the instance that either input power is applied or the module is enabled via the Standby pin. Following a delay of about 25 milli-secs, the voltages at  $Vo_1$  and  $Vo_2$  rise together until  $Vo_2$  reaches its set-point. Then  $Vo_1$  continues to rise until both output voltages have reached full voltage.

Figure 1; PT6980 Series Power-up

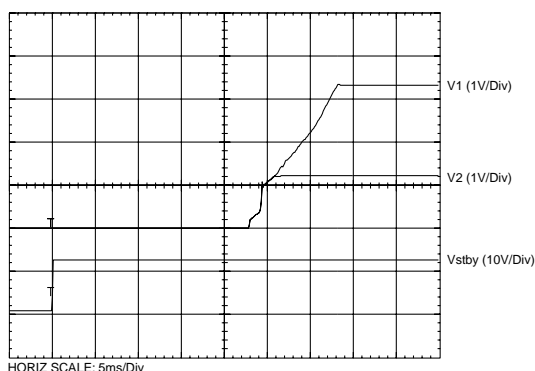

#### $Vo_1/Vo_2$ Loading

The output voltages from the PT6980 series regulators are independently regulated. The voltage at  $Vo_1$  is produced by a highly efficient switching regulator. The lower output voltage,  $Vo_2$ , is derived from  $Vo_1$ . The regulation method used for  $Vo_2$  also provides control of this output voltage during power-down.  $Vo_2$  will sink current if the voltage at  $Vo_1$  attempts to fall below it.

The load specifications for each model of the PT6980 series gives both a 'Typical' (Typ) and 'Maximum' (Max) load current for each output. For operation within the product's rating, the load currents at  $Vo_1$  and  $Vo_2$  must comply with the following limits:-

- $Io_2$  must be less than  $Io_2(\text{max})$ .
- The sum-total current from both outputs ( $Io_1 + Io_2$ ) must not exceed  $Io_1(\text{max})$ .

In the case that either  $Vo_1$  or  $Vo_2$  are adjusted to some other value than the default output voltage, the absolute maximum load current for  $Io_2$  must be revised to comply with the following equation.

$$Io_2(\text{max}) = \frac{2.5}{Vo_1 - Vo_2} \text{ A dc}$$

Consult the specification table for each model of the series for the actual numeric values.

### PT6981 Performance Specifications (Unless otherwise stated, $T_a = 25^\circ\text{C}$ , $V_{in} = 12\text{V}$ , $C_1 = 560\mu\text{F}$ , $C_2 = 330\mu\text{F}$ , $I_{O1} = I_{O1typ}$ , and $I_{O2} = I_{O2typ}$ )

Characteristic	Symbol	Conditions	PT6981 (2.5V/1.8V)			Units	
			Min	Typ	Max		
Output Current	$I_{O1}$	$T_a = 25^\circ\text{C}$ , natural convection	$V_{O1}$ (2.5V)	0.1 (i)	8 (ii)	10.5 (iii)	A
	$I_{O2}$		$V_{O2}$ (1.8V)	0	2.5 (ii)	2.5 (iii)	
	$I_{O1}$	$T_a = 60^\circ\text{C}$ , 200LFM airflow	$V_{O1}$ (2.5V)	0.1 (i)	8 (ii)	10.5 (iii)	A
	$I_{O2}$		$V_{O2}$ (1.8V)	0	2.5 (ii)	2.5 (iii)	
Input Voltage Range	$V_{in}$	Over $I_o$ Range		10.8	—	13.2	VDC
Set Point Voltage Tolerance	$V_o$ tol		$V_{O1}$	—	$\pm 12$	$\pm 38$	mV
			$V_{O2}$	—	$\pm 9$	$\pm 27$	
Temperature Variation	$\text{Reg}_{temp}$	$-40^\circ > T_a > +85^\circ\text{C}$	$V_{O1}$	—	$\pm 0.5$	—	% $V_o$
			$V_{O2}$	—	$\pm 0.5$	—	
Line Regulation	$\text{Reg}_{line}$	Over $V_{in}$ range	$V_{O1}$	—	$\pm 10$	$\pm 15$	mV
			$V_{O2}$	—	$\pm 5$	$\pm 7$	
Load Regulation	$\text{Reg}_{load}$	Over $I_o$ range	$V_{O1}$	—	$\pm 10$	$\pm 15$	mV
			$V_{O2}$	—	$\pm 5$	$\pm 7$	
Total Output Voltage Variation	$\Delta V_{otot}$	Includes set-point, line, load $-40^\circ > T_a > +85^\circ\text{C}$	$V_{O1}$	—	$\pm 44$	—	mV
			$V_{O2}$	—	$\pm 28$	—	
Efficiency	$\eta$			—	80	—	%
$V_o$ Ripple (pk-pk)	$V_r$	20MHz bandwidth	$V_{O1}$	—	35	—	mV <sub>pp</sub>
			$V_{O2}$	—	35	—	
Transient Response	$t_{tr}$	1A/ $\mu\text{s}$ load step, 50% to 100% $I_{Otyp}$		—	60	—	$\mu\text{s}$
	$\Delta V_{tr}$	$V_o$ over/undershoot	$V_{O1}$	—	$\pm 50$	—	mV
			$V_{O2}$	—	$\pm 20$	—	

**Notes:** (i)  $I_{O1}$  (min) current of 0.1A can be divided between both outputs,  $V_{O1}$  or  $V_{O2}$ . The module will operate at no load with reduced specifications.  
(ii) The typical current is that which can be drawn simultaneously from both outputs under the stated operating conditions.  
(iii) The sum of  $I_{O1}$  and  $I_{O2}$  must be less than  $I_{O1max}$ , and  $I_{O2}$  must be less than  $I_{O2max}$ .

### PT6981 Typical Characteristics

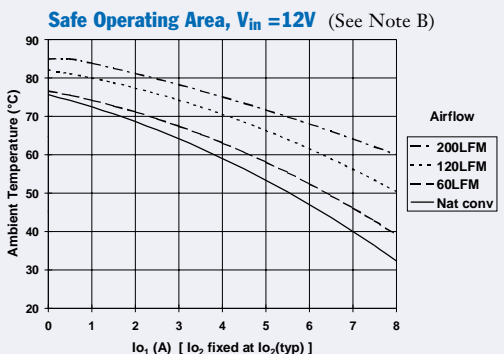
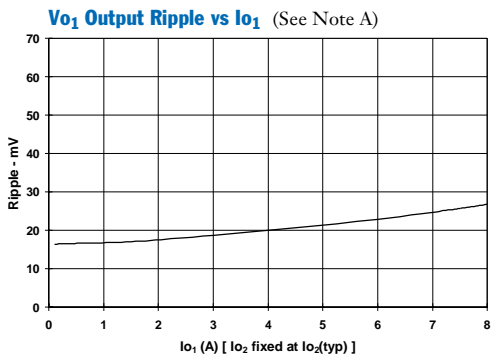
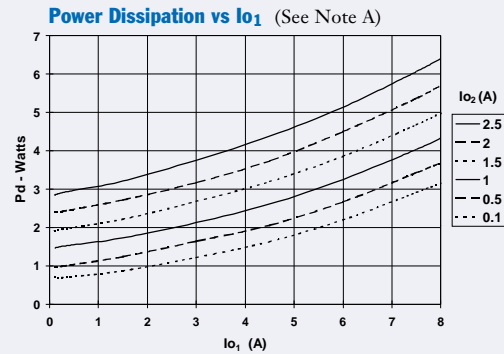
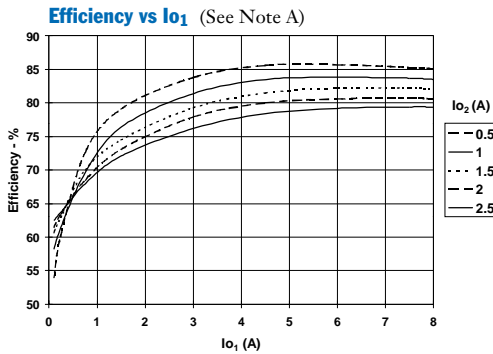

**Note A:** Characteristic data has been developed from actual products tested at  $25^\circ\text{C}$ . This data is considered typical data for the Converter.

**Note B:** SOA curves represent the conditions at which internal components are at or below the manufacturer's maximum operating temperatures

### PT6982 Performance Specifications (Unless otherwise stated, $T_a = 25^\circ\text{C}$ , $V_{in} = 12\text{V}$ , $C_1 = 560\mu\text{F}$ , $C_2 = 330\mu\text{F}$ , $I_{O1} = I_{O1\text{typ}}$ , and $I_{O2} = I_{O2\text{typ}}$ )

Characteristic	Symbol	Conditions	PT6982 (3.3V/2.5V)			Units	
			Min	Typ	Max		
Output Current	$I_{O1}$	$T_a = 25^\circ\text{C}$ , natural convection	$V_{O1}$ (3.3V)	0.1 (i)	8.5 (ii)	10.5 (iii)	A
	$I_{O2}$		$V_{O2}$ (2.5V)	0	2	2.25 (iii)	
	$I_{O1}$	$T_a = 60^\circ\text{C}$ , 200LFM airflow	$V_{O1}$ (3.3V)	0.1 (i)	8.5 (ii)	10.5 (iii)	A
	$I_{O2}$		$V_{O2}$ (2.5V)	0	2	2.25 (iii)	
Input Voltage Range	$V_{in}$	Over $I_O$ Range		10.8	—	13.2	VDC
Set Point Voltage Tolerance	$V_o \text{ tol}$		$V_{O1}$	—	$\pm 16$	$\pm 50$	mV
			$V_{O2}$	—	$\pm 12$	$\pm 38$	
Temperature Variation	$\text{Reg}_{\text{temp}}$	$-40^\circ > T_a > +85^\circ\text{C}$	$V_{O1}$	—	$\pm 1.0$	—	% $V_o$
			$V_{O2}$	—	$\pm 0.5$	—	
Line Regulation	$\text{Reg}_{\text{line}}$	Over $V_{in}$ range	$V_{O1}$	—	$\pm 10$	$\pm 15$	mV
			$V_{O2}$	—	$\pm 5$	$\pm 7$	
Load Regulation	$\text{Reg}_{\text{load}}$	Over $I_O$ range	$V_{O1}$	—	$\pm 10$	$\pm 15$	mV
			$V_{O2}$	—	$\pm 10$	$\pm 13$	
Total Output Voltage Variation	$\Delta V_{o\text{tot}}$	Includes set-point, line, load $-40^\circ > T_a > +85^\circ\text{C}$	$V_{O1}$	—	$\pm 69$	—	mV
			$V_{O2}$	—	$\pm 39$	—	
Efficiency	$\eta$			—	84	—	%
$V_o$ Ripple (pk-pk)	$V_r$	20MHz bandwidth	$V_{O1}$	—	35	—	mV <sub>pp</sub>
			$V_{O2}$	—	35	—	
Transient Response	$t_{tr}$	$1\text{A}/\mu\text{s}$ load step, 50% to 100% $I_{O\text{typ}}$	$V_{O1}$	—	60	—	$\mu\text{s}$
	$\Delta V_{tr}$	$V_o$ over/undershoot	$V_{O1}$	—	$\pm 50$	—	mV
			$V_{O2}$	—	$\pm 30$	—	

**Notes:** (i)  $I_{O1}$  (min) current of 0.1A can be divided between both outputs,  $V_{O1}$  or  $V_{O2}$ . The module will operate at no load with reduced specifications.  
(ii) The typical current is that which can be drawn simultaneously from both outputs under the stated operating conditions.  
(iii) The sum of  $I_{O1}$  and  $I_{O2}$  must be less than  $I_{O1\text{max}}$ , and  $I_{O2}$  must be less than  $I_{O2\text{max}}$ .

### PT6982 Typical Characteristics

**Efficiency vs  $I_{O1}$**  (See Note A)

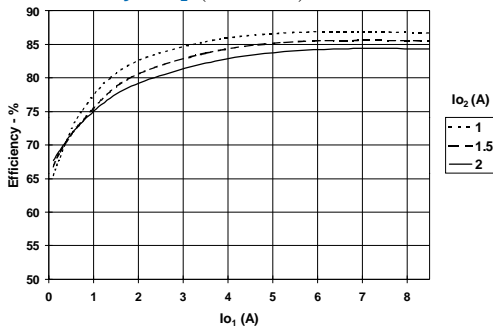

**Power Dissipation vs  $I_{O1}$**  (See Note A)

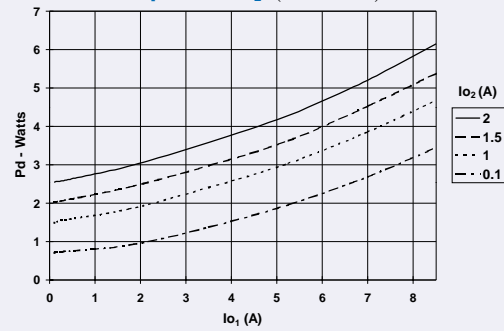

**$V_{O1}$  Output Ripple vs  $I_{O1}$**  (See Note A)

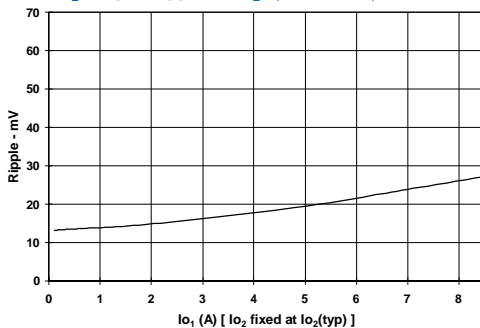

**Safe Operating Area,  $V_{in} = 12\text{V}$**  (See Note B)

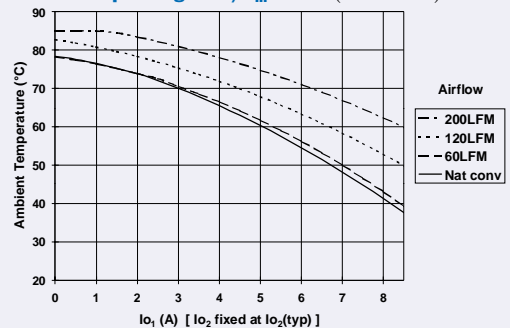

**Note A:** Characteristic data has been developed from actual products tested at  $25^\circ\text{C}$ . This data is considered typical data for the Converter.

**Note B:** SOA curves represent the conditions at which internal components are at or below the manufacturer's maximum operating temperatures

### PT6983 Performance Specifications (Unless otherwise stated, $T_a = 25^\circ\text{C}$ , $V_{in} = 12\text{V}$ , $C_1 = 560\mu\text{F}$ , $C_2 = 330\mu\text{F}$ , $I_{O1} = I_{O1typ}$ , and $I_{O2} = I_{O2typ}$ )

Characteristic	Symbol	Conditions	PT6983 (3.3V/1.8V)			Units	
			Min	Typ	Max		
Output Current	$I_{O1}$	$T_a = 25^\circ\text{C}$ , natural convection	$V_{O1}$ (3.3V)	0.1 (i)	7.5 (ii)	9.5 (iii)	A
	$I_{O2}$		$V_{O2}$ (1.8V)	0	2 (ii)	2 (iii)	
	$I_{O1}$	$T_a = 60^\circ\text{C}$ , 200LFM airflow	$V_{O1}$ (3.3V)	0.1 (i)	7.5 (ii)	9.5 (iii)	A
	$I_{O2}$		$V_{O2}$ (1.8V)	0	2 (ii)	2 (iii)	
Input Voltage Range	$V_{in}$	Over $I_o$ Range		10.8	—	13.2	VDC
Set Point Voltage Tolerance	$V_o$ tol		$V_{O1}$	—	$\pm 16$	$\pm 50$	mV
			$V_{O2}$	—	$\pm 9$	$\pm 27$	
Temperature Variation	$\text{Reg}_{temp}$	$-40^\circ > T_a > +85^\circ\text{C}$	$V_{O1}$	—	$\pm 1.0$	—	$\%V_o$
Line Regulation	$\text{Reg}_{line}$	Over $V_{in}$ range	$V_{O1}$	—	$\pm 10$	$\pm 15$	mV
			$V_{O2}$	—	$\pm 5$	$\pm 7$	
Load Regulation	$\text{Reg}_{load}$	Over $I_o$ range	$V_{O1}$	—	$\pm 10$	$\pm 15$	mV
			$V_{O2}$	—	$\pm 5$	$\pm 7$	
Total Output Voltage Variation	$\Delta V_{otot}$	Includes set-point, line, load $-40^\circ > T_a > +85^\circ\text{C}$	$V_{O1}$	—	$\pm 69$	—	mV
			$V_{O2}$	—	$\pm 28$	—	
Efficiency	$\eta$			—	81	—	%
$V_o$ Ripple (pk-pk)	$V_r$	20MHz bandwidth	$V_{O1}$	—	3.5	—	mV <sub>pp</sub>
			$V_{O2}$	—	3.5	—	
Transient Response	$t_{tr}$	1A/ $\mu\text{s}$ load step, 50% to 100% $I_{Otyp}$	$V_{O1}$	—	60	—	$\mu\text{s}$
	$\Delta V_{tr}$	$V_o$ over/undershoot	$V_{O1}$	—	$\pm 50$	—	mV
			$V_{O2}$	—	$\pm 20$	—	

**Notes:** (i)  $I_{O1}$  (min) current of 0.1A can be divided between both outputs,  $V_{O1}$  or  $V_{O2}$ . The module will operate at no load with reduced specifications.  
(ii) The typical current is that which can be drawn simultaneously from both outputs under the stated operating conditions.  
(iii) The sum of  $I_{O1}$  and  $I_{O2}$  must be less than  $I_{O1max}$ , and  $I_{O2}$  must be less than  $I_{O2max}$ .

### PT6983 Typical Characteristics

**Efficiency vs  $I_{O1}$**  (See Note A)

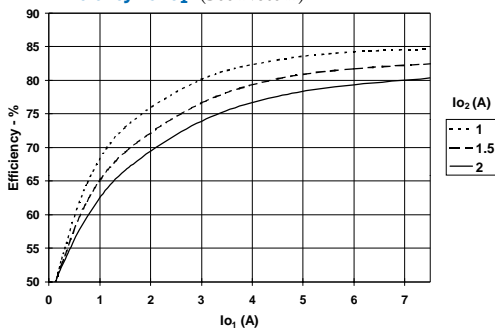

**Power Dissipation vs  $I_{O1}$**  (See Note A)

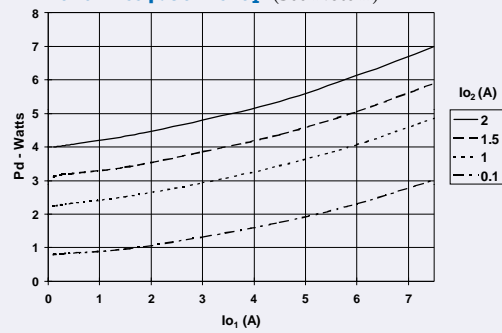

**$V_{O1}$  Output Ripple vs  $I_{O1}$**  (See Note A)

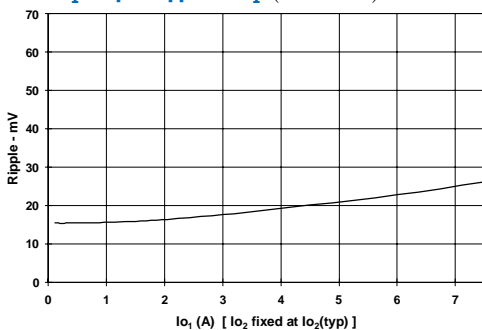

**Safe Operating Area,  $V_{in} = 12\text{V}$**  (See Note B)

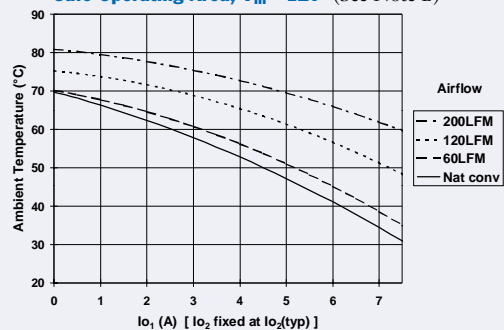

**Note A:** Characteristic data has been developed from actual products tested at  $25^\circ\text{C}$ . This data is considered typical data for the Converter.

**Note B:** SOA curves represent the conditions at which internal components are at or below the manufacturer's maximum operating temperatures

### PT6984 Performance Specifications (Unless otherwise stated, $T_a = 25^\circ\text{C}$ , $V_{in} = 12\text{V}$ , $C_1 = 560\mu\text{F}$ , $C_2 = 330\mu\text{F}$ , $I_{O1} = I_{O1\text{typ}}$ , and $I_{O2} = I_{O2\text{typ}}$ )

Characteristic	Symbol	Conditions	PT6984 (3.3V/1.2V)			Units	
			Min	Typ	Max		
Output Current	$I_{O1}$	$T_a = 25^\circ\text{C}$ , natural convection	$V_{O1}$ (3.3V)	0.1 (i)	7 (ii)	8.6 (iii)	A
	$I_{O2}$		$V_{O2}$ (1.2V)	0	1.6 (ii)	1.6 (iii)	
Input Voltage Range	$V_{in}$	Over $I_O$ Range		10.8	—	13.2	VDC
	Set Point Voltage Tolerance	$V_o$ tol	$V_{O1}$ $V_{O2}$	— —	$\pm 16$ $\pm 6$	$\pm 50$ $\pm 18$	
Temperature Variation	$\text{Reg}_{\text{temp}}$	$-40^\circ > T_a > +85^\circ\text{C}$	$V_{O1}$ $V_{O2}$	— —	$\pm 1.0$ $\pm 0.5$	— —	% $V_o$
Line Regulation	$\text{Reg}_{\text{line}}$	Over $V_{in}$ range	$V_{O1}$ $V_{O2}$	— —	$\pm 10$ $\pm 5$	$\pm 15$ $\pm 7$	
Load Regulation	$\text{Reg}_{\text{load}}$	Over $I_O$ range	$V_{O1}$ $V_{O2}$	— —	$\pm 10$ $\pm 5$	$\pm 15$ $\pm 7$	mV
Total Output Voltage Variation	$\Delta V_{o\text{tot}}$	Includes set-point, line, load $-40^\circ > T_a > +85^\circ\text{C}$	$V_{O1}$ $V_{O2}$	— —	$\pm 69$ $\pm 22$	— —	
Efficiency	$\eta$			—	78	—	%
$V_o$ Ripple (pk-pk)	$V_r$	20MHz bandwidth	$V_{O1}$ $V_{O2}$	— —	35 35	— —	
Transient Response	$t_{tr}$	1A/ $\mu\text{s}$ load step, 50% to 100% $I_{O\text{typ}}$		—	60	—	$\mu\text{s}$
	$\Delta V_{tr}$	$V_o$ over/undershoot	$V_{O1}$ $V_{O2}$	— —	$\pm 50$ $\pm 20$	— —	

**Notes:** (i)  $I_{O1}$  (min) current of 0.1A can be divided between both outputs,  $V_{O1}$  or  $V_{O2}$ . The module will operate at no load with reduced specifications.  
(ii) The typical current is that which can be drawn simultaneously from both outputs under the stated operating conditions.  
(iii) The sum of  $I_{O1}$  and  $I_{O2}$  must be less than  $I_{O1\text{max}}$ , and  $I_{O2}$  must be less than  $I_{O2\text{max}}$ .

### PT6984 Typical Characteristics

**Efficiency vs  $I_{O1}$**  (See Note A)

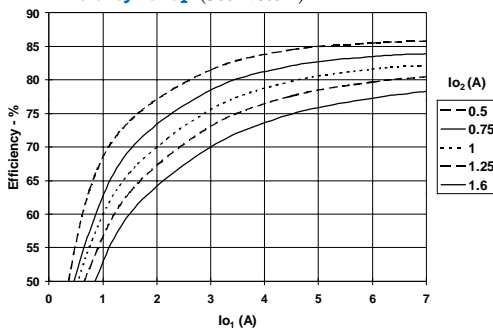

**Power Dissipation vs  $I_{O1}$**  (See Note A)

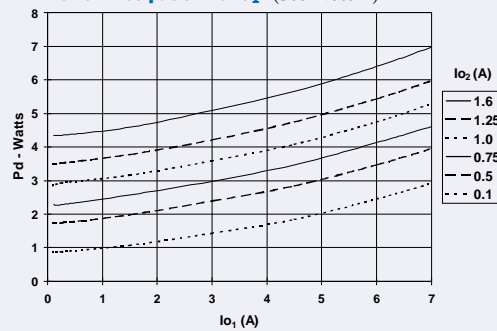

**$V_{O1}$  Output Ripple vs  $I_{O1}$**  (See Note A)

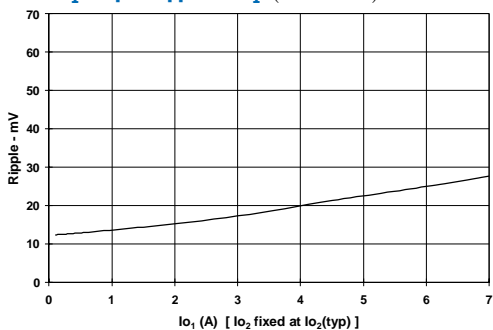

**Safe Operating Area,  $V_{in} = 12\text{V}$**  (See Note B)

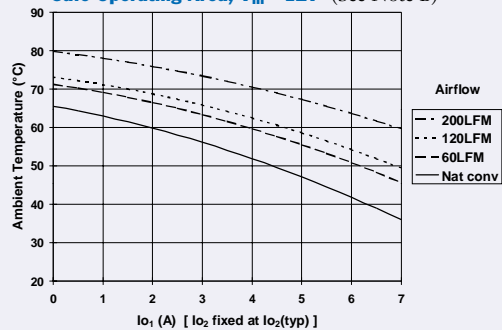

**Note A:** Characteristic data has been developed from actual products tested at  $25^\circ\text{C}$ . This data is considered typical data for the Converter.

**Note B:** SOA curves represent the conditions at which internal components are at or below the manufacturer's maximum operating temperatures

### PT6985 Performance Specifications (Unless otherwise stated, $T_a = 25^\circ\text{C}$ , $V_{in} = 12\text{V}$ , $C_1 = 560\mu\text{F}$ , $C_2 = 330\mu\text{F}$ , $I_{O1} = I_{O1typ}$ , and $I_{O2} = I_{O2typ}$ )

Characteristic	Symbol	Conditions	PT6985 (2.5V/1.2V)			Units	
			Min	Typ	Max		
Output Current	$I_{O1}$	$T_a = 25^\circ\text{C}$ , natural convection	$V_{O1}$ (2.5V)	0.1 (i)	7 (ii)	9 (iii)	A
	$I_{O2}$		$V_{O2}$ (1.2V)	0	2 (ii)	2.2 (iii)	
	$I_{O1}$	$T_a = 60^\circ\text{C}$ , 200LFM airflow	$V_{O1}$ (2.5V)	0.1 (i)	7 (ii)	9 (iii)	A
	$I_{O2}$		$V_{O2}$ (1.2V)	0	2 (ii)	2.2 (iii)	
Input Voltage Range	$V_{in}$	Over $I_o$ Range		10.8	—	13.2	VDC
Set Point Voltage Tolerance	$V_o \text{ tol}$		$V_{O1}$	—	$\pm 12$	$\pm 38$	mV
			$V_{O2}$	—	$\pm 6$	$\pm 18$	
Temperature Variation	$\text{Reg}_{temp}$	$-40^\circ > T_a > +85^\circ\text{C}$	$V_{O1}$	—	$\pm 0.5$	—	% $V_o$
			$V_{O2}$	—	$\pm 0.5$	—	
Line Regulation	$\text{Reg}_{line}$	Over $V_{in}$ range	$V_{O1}$	—	$\pm 10$	$\pm 15$	mV
			$V_{O2}$	—	$\pm 5$	$\pm 7$	
Load Regulation	$\text{Reg}_{load}$	Over $I_o$ range	$V_{O1}$	—	$\pm 10$	$\pm 15$	mV
			$V_{O2}$	—	$\pm 5$	$\pm 7$	
Total Output Voltage Variation	$\Delta V_{otot}$	Includes set-point, line, load $-40^\circ > T_a > +85^\circ\text{C}$	$V_{O1}$	—	$\pm 44$	—	mV
			$V_{O2}$	—	$\pm 22$	—	
Efficiency	$\eta$			—	77	—	%
$V_o$ Ripple (pk-pk)	$V_r$	20MHz bandwidth	$V_{O1}$	—	35	—	mV <sub>pp</sub>
			$V_{O2}$	—	35	—	
Transient Response	$t_{tr}$	1A/ $\mu\text{s}$ load step, 50% to 100% $I_{Otyp}$		—	60	—	$\mu\text{s}$
	$\Delta V_{tr}$	$V_o$ over/undershoot	$V_{O1}$	—	$\pm 50$	—	mV
			$V_{O2}$	—	$\pm 20$	—	

**Notes:** (i)  $I_{O1}$  (min) current of 0.1A can be divided between both outputs,  $V_{O1}$  or  $V_{O2}$ . The module will operate at no load with reduced specifications.  
(ii) The typical current is that which can be drawn simultaneously from both outputs under the stated operating conditions.  
(iii) The sum of  $I_{O1}$  and  $I_{O2}$  must be less than  $I_{O1max}$ , and  $I_{O2}$  must be less than  $I_{O2max}$ .

### PT6985 Typical Characteristics

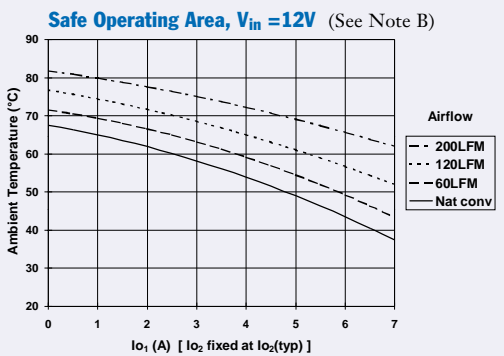
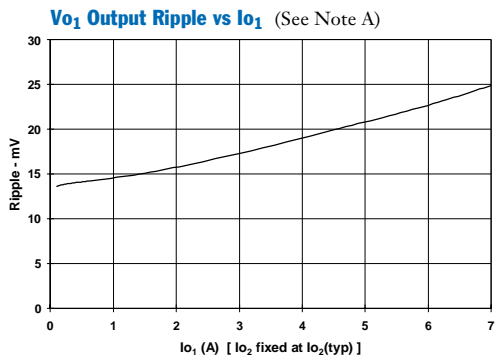
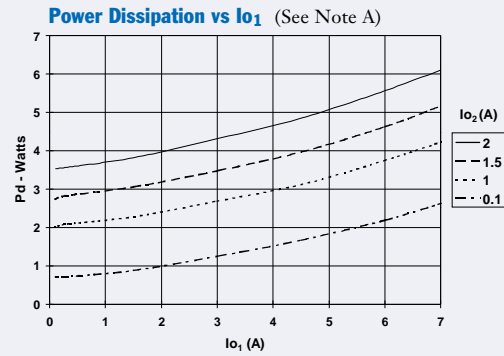
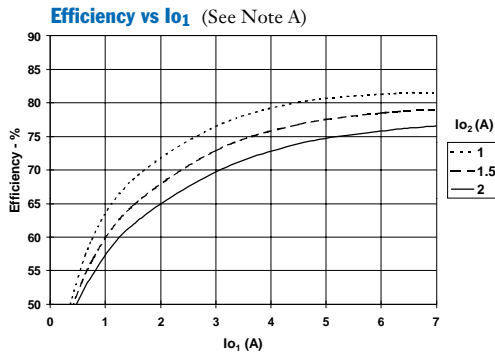

**Note A:** Characteristic data has been developed from actual products tested at  $25^\circ\text{C}$ . This data is considered typical data for the Converter.

**Note B:** SOA curves represent the conditions at which internal components are at or below the manufacturer's maximum operating temperatures

## Capacitor Recommendations for the Dual-Output PT6980 Regulator Series

### Input Capacitors:

The recommended input capacitance is determined by 1.0 ampere minimum ripple current rating and 330µF minimum capacitance. Ripple current and <100mΩ equivalent series resistance (ESR) values are the major considerations, along with temperature, when designing with different types of capacitors. Tantalum capacitors have a recommended minimum voltage rating of 2 × the maximum DC voltage + AC ripple. This is necessary to insure reliability for input voltage bus applications

### Output Capacitors: C<sub>2</sub>(Required), C<sub>3</sub>(Optional)

The ESR of the required capacitor (C<sub>2</sub>) must not be greater than 50mΩ. Electrolytic capacitors have poor ripple performance at frequencies greater than 400kHz but excellent low frequency transient response. Above the ripple frequency, ceramic capacitors are necessary to improve the transient response and reduce any high frequency noise components apparent during higher current excursions. Preferred low ESR type capacitor part numbers are identified in Table 1. The optional 100µF capacitor (C<sub>3</sub>) for V<sub>2</sub>out can have an ESR of up to 200mΩ for optimum performance and ripple reduction. (Note: Vendor part numbers for the optional capacitor, C<sub>3</sub>, are not identified in the table. Use the same series selected for C<sub>2</sub>)

### Tantalum Capacitors

Tantalum type capacitors may be used at the output, but only the AVX TPS series, Sprague 593D/594/595 series, or Kemet T495/T510 series. The AVX TPS series, Kemet or Sprague series tantalums are recommended over many other types due to their higher rated surge, power dissipation, and ripple current capability. As a caution, the TAJ series by AVX is not recommended. This series has considerably higher ESR, reduced power dissipation and lower ripple current capability. The TAJ Series is also less reliable than the AVX TPS series when determining power dissipation capability. Tantalum or Oscon® types are recommended for applications where ambient temperatures fall below 0°C.

### Capacitor Table

Table 1 identifies the characteristics of capacitors from a number of vendors with acceptable ESR and ripple current (rms) ratings. The number of capacitors required at both the input and output buses is identified for each capacitor type.

*This is not an extensive capacitor list. Capacitors from other vendors are available with comparable specifications. Those listed are for guidance. The RMS ripple current rating and ESR (Equivalent Series Resistance at 100kHz) are critical parameters necessary to insure both optimum regulator performance and long capacitor life.*

**Table 1: Input/Output Capacitors**

Capacitor Vendor/ Component Series	Capacitor Characteristics					Quantity		Vendor Number
	Working Voltage	Value(µF)	(ESR) Equivalent Series Resistance	85°C Maximum Ripple Current(Irms)	Physical Size(mm)	Input Bus	Output Bus	
Panasonic FC	35V	680µF	0.043Ω	1690mA	16x15	1	1	EEUFC1V681S
	35V	560µF	0.038Ω	1655mA	12.5x20	1	1	EEUFC1V561S
	50V	680µF	0.048Ω	1835mA	16x20	1	1	EEUFC1H681
Un ited Chemi-con LXV/LXZ/FX/FS	35V	680µF	0.038Ω	1660mA	12.5x20	1	1	LXZ35VB681M112X20LL
	50V	680µF	0.048Ω	1840mA	16x20	1	1	LXZ50VB681M16X20LL
	10V	390µF	0.030Ω	3080mA	8x10.5	N/R	1	10FX390M
	20V	150µF	0.024Ω	3200mA	8x10.5	4	2	20FX150M
Nichicon PL/PM	35V	560µF	0.048Ω	1360mA	16x15	1	1	UPL1V561MHH6
	25V	820µF	0.049Ω	1340mA	16x15	1	1	UPL1E821MHH6
	35V	560µF	0.0048Ω	1360mA	16x15	1	1	UPM1V561MHH6
Panasonic FC Surface Mtg	35V	330µF	0.065+2Ω	>1205mA	12.5x16.5	2	2	EEVFC1V331LQ
	35V	1000µF	0.038Ω	2000mA	18x16.5	1	1	EEVFC1V1021N
	35V	470µF	0.043Ω	1690mA	16x16.5	1	1	EEVFC1V471N
Oscon SS/SV	10V	330µF	0.025Ω	>3500mA	10.0x10.5	N/R	1	10SS330M
	10V	330µF	0.025Ω	>3800mA	10.3x10.3	N/R	1	10SV330M Surface Mount(SV)
AVX Tantalum TPS	10V	330µF	0.060+2Ω	>2500mA	7.3Lx	N/R	2	TPSV337M010R0060
	10V	220µF	0.060+2Ω	>3000mA	4.3Wx	N/R	2	TPSV227M010R0060
Kemet T510 T495	10V	330µF	0.033Ω	1400mA	7.3Lx5.7W x 4.0H	N/R	1	T510X337M010AS
	10V	220µF	0.07Ω+2 =0.035Ω	>2000mA		N/R	2	T495X227M010AS
Sprague 594D	10V	330µF	0.045Ω	2350mA	7.3Lx 6.0Wx 4.1H	N/R	1	594D337X0010R2T

N/R –Not recommended. The voltage rating does not meet the minimim operating limits.

## Adjusting the Output Voltage of the PT6980 Dual-Output Voltage Regulators

Each output voltage from the PT6980 series of integrated switching regulators (ISRs) can be independently adjusted higher or lower than the factory trimmed pre-set voltage. The voltages,  $V_{O1}$  and  $V_{O2}$  may be adjusted either up or down using a single external resistor <sup>1</sup>. Table 1 gives the adjustment range for both  $V_{O1}$  and  $V_{O2}$  for each model in the series as  $V_a(\text{min})$  and  $V_a(\text{max})$ . Note that  $V_{O2}$  must always be lower than  $V_{O1}$  <sup>2</sup>.

**$V_{O1}$  Adjust Up:** To increase the output, add a resistor  $R_4$  between pin 16 ( $V_1$  Adjust) and pins 7-11 (GND) <sup>1</sup>.

**$V_{O1}$  Adjust Down:** Add a resistor ( $R_3$ ), between pin 16 ( $V_{O1}$  Adjust) and pin 1 ( $V_{O1}$  Sense) <sup>1</sup>.

**$V_{O2}$  Adjust Up:** Add a resistor  $R_2$  between pin 23 ( $V_{O2}$  Adjust) and pins 7-11 (GND) <sup>1</sup>.

**$V_{O2}$  Adjust Down:** Add a resistor ( $R_1$ ) between pin 23 ( $V_{O2}$  Adjust) and pin 22 ( $V_{O2}$  Sense) <sup>1</sup>.

Refer to Figure 1 and Table 2 for both the placement and value of the required resistor.

### Notes:

- Use only a single 1% resistor in either the ( $R_3$ ) or  $R_4$  location to adjust  $V_{O1}$ , and in the ( $R_1$ ) or  $R_2$  location to adjust  $V_{O2}$ . Place the resistor as close to the ISR as possible.
- $V_{O2}$  must always be at least 0.2V lower than  $V_{O1}$ .

- Both the  $V_{O1}$  and  $V_{O2}$  may be adjusted down to an alternative bus voltage by making, ( $R_3$ ) or ( $R_1$ ) respectively, a zero ohm link. Refer to the Table 1 footnotes for guidance.
- Never connect capacitors to either the  $V_{O1}$  Adjust or  $V_{O2}$  Adjust pins. Any capacitance added to these control pins will affect the stability of the respective regulated output.
- Adjusting either voltage ( $V_{O1}$  or  $V_{O2}$ ) may increase the power dissipation in the regulator, and change the maximum current available at either output. Consult the note on p.2 of the data sheet regarding  $V_{O1}/V_{O2}$  loading.

The adjust up and adjust down resistor values can also be calculated using the following formulas. Be sure to select the correct formula parameter from Table 1 for the output and model being adjusted.

$$(R_1) \text{ or } (R_3) = \frac{10(V_a - V_r)}{V_o - V_a} - R_s \quad \text{k}\Omega$$

$$(R_2) \text{ or } (R_4) = \frac{10 \cdot V_r}{V_a - V_o} - R_s \quad \text{k}\Omega$$

Where:  $V_o$  = Original output voltage, ( $V_{O1}$  or  $V_{O2}$ )  
 $V_a$  = Adjusted output voltage  
 $V_r$  = The reference voltage from Table 1  
 $R_s$  = The series resistance from Table 1

Figure 1

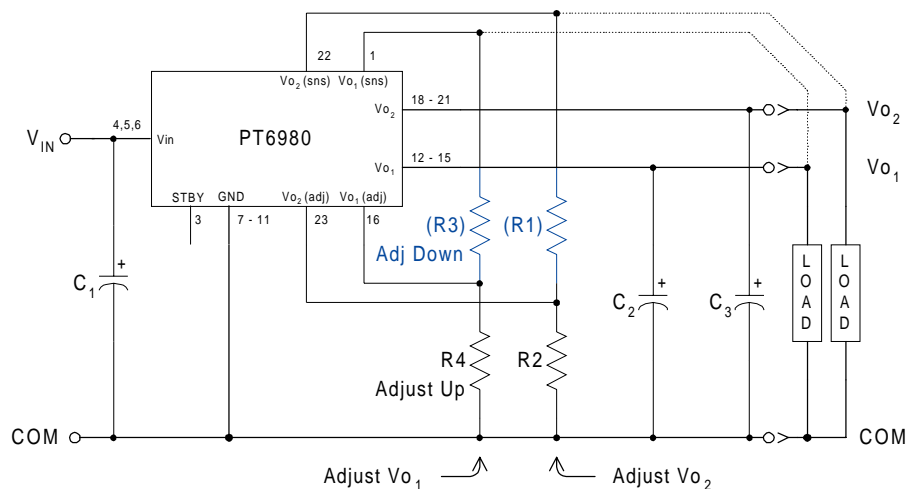

**Table 1**

**ADJUSTMENT RANGE AND FORMULA PARAMETERS**

Vo1 Bus			Vo2 Bus (2)		
Series Pt #	PT6981/85	PT6982/83/84	PT6984/85	PT6981/83	PT6936
Adj. Resistor	(R3)/R4	(R3)/R4	(R1)/R2	(R1)/R2	(R1)/R2
V <sub>o</sub> (nom)	2.5V	3.3V	1.2V	1.8V	2.5V
V <sub>a</sub> (min)	1.8V *	2.5V *	1.0V †	1.5V †	1.8V †
V <sub>a</sub> (max)	3.6V	3.6V	1.5V #	2.4V	3.0
V <sub>r</sub>	1.27V	1.27V	0.6125V	1.0V	1.0V
R <sub>s</sub> (kΩ)	7.5	15.4	20.0	16.9	11.5

Ref. Note 3: \* (R3) = Zero-ohm link  
 † (R1) = Zero-ohm link  
 # (R2) = Zero-ohm link

**Table 2**

**ADJUSTMENT RESISTOR VALUES**

Vo1 Bus			Vo2 Bus			
Series Pt #	PT6981/85	PT6982/83/84	Series Pt #	PT6984/85	PT6981/83	PT6982
Adj. Resistor	(R3)/R4	(R3)/R4	Adj. Resistor	(R1)/R2	(R1)/R2	(R1)/R2
V <sub>o</sub> (nom)	2.5V	3.3V	V <sub>o</sub> (nom)	1.2V	1.8V	2.5V
V <sub>a</sub> (req'd)			V <sub>a</sub> (req'd)			
1.8	(0.0)		1.0	(0.0)kΩ		
1.85	(1.4)kΩ		1.05	(9.2)kΩ		
1.9	(3.0)kΩ		1.1	(28.8)kΩ		
1.95	(4.9)kΩ		1.15	(87.5)kΩ		
2.0	(7.1)kΩ		1.2			
2.05	(9.8)kΩ		1.25	101.5kΩ		
2.1	(13.3)kΩ		1.3	41.2kΩ		
2.2	(23.5)kΩ		1.35	20.8kΩ		
2.3	(44.0)kΩ		1.4	10.6kΩ		
2.4	(106.0)kΩ		1.45	4.5kΩ		
2.5		(0.0)kΩ	1.5	0.0kΩ	(0.0)kΩ	
2.6	120.0kΩ	(3.6)kΩ	1.55		(5.1)kΩ	
2.7	56.0kΩ	(8.4)kΩ	1.6		(13.1)kΩ	
2.8	34.8kΩ	(15.2)kΩ	1.65		(26.4)kΩ	
2.9	24.3kΩ	(25.4)kΩ	1.7		(53.1)kΩ	
3.0	17.9kΩ	(42.3)kΩ	1.75		(133.0)kΩ	
3.1	13.7kΩ	(76.1)kΩ	1.8			(0.0)kΩ
3.2	10.6kΩ	(178.0)kΩ	1.85		183.0kΩ	(1.6)kΩ
3.3	8.4kΩ		1.9		83.1kΩ	(3.5)kΩ
3.4	6.6kΩ	112.0k	1.95		49.8kΩ	(5.8)kΩ
3.5	5.2kΩ	48.1k	2.0		33.1kΩ	(8.5)kΩ
3.6	4.1kΩ	26.9k	2.05		23.1kΩ	(11.8)kΩ
			2.1		16.4kΩ	(16.0)kΩ
			2.2		8.1kΩ	(28.5)kΩ
			2.3		3.1kΩ	(53.5)kΩ
			2.4		0.0kΩ	(129.0)kΩ
			2.5			
			2.6			88.5kΩ
			2.7			38.5kΩ
			2.8			21.8kΩ
			2.9			13.5kΩ
			3.0			8.5kΩ

R<sub>1</sub>/R<sub>3</sub> = (Blue), R<sub>2</sub>/R<sub>4</sub> = Black

## Using the Standby Function on the PT6980 Series of Dual-Output Voltage Regulators

Both output voltages of the 23-pin PT6980 dual-output converter may be disabled using the regulator's 'Standby' function. This function may be used in applications that require power-up/shutdown sequencing, or wherever there is a requirement to control the output voltage On/Off status with external circuitry.

The standby function is provided by the *STBY*\* control (pin 3). If pin 3 is left open-circuit the regulator operates normally, and provides a regulated output at both  $V_{O1}$  (pins 12–15) and  $V_{O2}$  (pins 18–21) whenever a valid supply voltage is applied to  $V_{in}$  (pins 4, 5, & 6) with respect to GND (pins 7–11). If a low voltage<sup>1</sup> is then applied to pin-3 both regulator outputs will be simultaneously disabled and the input current drawn by the ISR will drop to a typical value of 4mA. The standby control may also be used to hold-off both regulator outputs during the period that input power is applied.

The standby pin is ideally controlled using an open-collector (or open-drain) discrete transistor (See Figure 1). The open-circuit voltage is the input voltage  $+V_{in}$ . Table 1 gives the circuit parameters for this control input.

**Table 1 Standby Control Parameters**<sup>1, 2</sup>

Parameter	Min	TYP	Max
Enable ( $V_{IH}$ )	—	—	Open circuit
Disable ( $V_{IL}$ )	-0.1V	—	0.4V <sup>1</sup>
$V_{STBY}$ (open circuit)	—	$+V_{in}$ <sup>2</sup>	—
$I_{STBY}$ ( $I_{IL}$ )	—	—	-0.5mA

### Notes:

- The standby control input is Not compatible with TTL or other devices that incorporate a totem-pole output drive. Use only a true open-collector device, preferably a discrete bipolar transistor (or MOSFET). To ensure the regulator output is disabled, the control pin must be pulled to less than 0.4Vdc with a low-level 0.5mA sink to ground.
- The standby control input requires no external pull-up resistor. The open-circuit voltage of the *STBY*\* pin is the input voltage  $+V_{in}$ .
- When the regulator output is disabled the current drawn from the input source is typically reduced to 4mA.

**Figure 1**

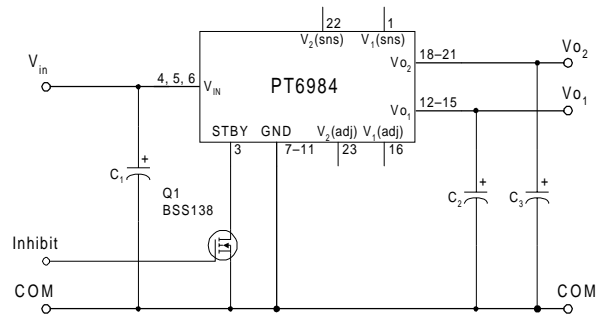

**Turn-On Time:** Turning  $Q_1$  in Figure 1 off removes the low-voltage signal at pin 3 and enables the PT6980 series regulator. Following a delay of about 25ms,  $V_{O1}$  and  $V_{O2}$  rise together until the lower voltage,  $V_{O2}$ , reaches its set output.  $V_{O1}$  continues to rise until both outputs reach full regulation voltage. The total power-up time is less than 40ms, and is relatively independent of load, temperature, and output capacitance. Figure 2 shows waveforms of the output voltages,  $V_{O1}$  and  $V_{O2}$ , for a PT6984 (3.3V/1.2V). The turn-off of  $Q_1$  corresponds to the rise in  $V_{STBY}$ . The waveforms were measured with a 12V input voltage, and with resistive loads of 5A and 1.25A at the  $V_{O1}$  and  $V_{O2}$  outputs respectively.

**Figure 2**

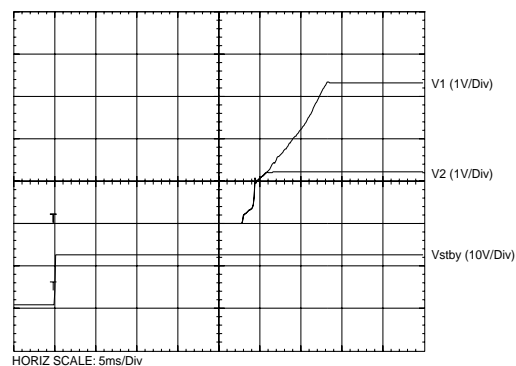

**PACKAGING INFORMATION**

Orderable Device	Status <sup>(1)</sup>	Package Type	Package Drawing	Pins	Package Qty	Eco Plan <sup>(2)</sup>	Lead/ Ball Finish	MSL Peak Temp <sup>(3)</sup>	Samples (Requires Login)
PT6983N	ACTIVE	SIP MODULE	ELF	23	10	Pb-Free (RoHS)	Call TI	N / A for Pkg Type	
PT6984N	ACTIVE	SIP MODULE	ELF	23	10	Pb-Free (RoHS)	Call TI	N / A for Pkg Type	

<sup>(1)</sup> The marketing status values are defined as follows:

**ACTIVE:** Product device recommended for new designs.

**LIFEBUY:** TI has announced that the device will be discontinued, and a lifetime-buy period is in effect.

**NRND:** Not recommended for new designs. Device is in production to support existing customers, but TI does not recommend using this part in a new design.

**PREVIEW:** Device has been announced but is not in production. Samples may or may not be available.

**OBSELETE:** TI has discontinued the production of the device.

<sup>(2)</sup> Eco Plan - The planned eco-friendly classification: Pb-Free (RoHS), Pb-Free (RoHS Exempt), or Green (RoHS & no Sb/Br) - please check <http://www.ti.com/productcontent> for the latest availability information and additional product content details.

**TBD:** The Pb-Free/Green conversion plan has not been defined.

**Pb-Free (RoHS):** TI's terms "Lead-Free" or "Pb-Free" mean semiconductor products that are compatible with the current RoHS requirements for all 6 substances, including the requirement that lead not exceed 0.1% by weight in homogeneous materials. Where designed to be soldered at high temperatures, TI Pb-Free products are suitable for use in specified lead-free processes.

**Pb-Free (RoHS Exempt):** This component has a RoHS exemption for either 1) lead-based flip-chip solder bumps used between the die and package, or 2) lead-based die adhesive used between the die and leadframe. The component is otherwise considered Pb-Free (RoHS compatible) as defined above.

**Green (RoHS & no Sb/Br):** TI defines "Green" to mean Pb-Free (RoHS compatible), and free of Bromine (Br) and Antimony (Sb) based flame retardants (Br or Sb do not exceed 0.1% by weight in homogeneous material)

<sup>(3)</sup> MSL, Peak Temp. -- The Moisture Sensitivity Level rating according to the JEDEC industry standard classifications, and peak solder temperature.

**Important Information and Disclaimer:** The information provided on this page represents TI's knowledge and belief as of the date that it is provided. TI bases its knowledge and belief on information provided by third parties, and makes no representation or warranty as to the accuracy of such information. Efforts are underway to better integrate information from third parties. TI has taken and continues to take reasonable steps to provide representative and accurate information but may not have conducted destructive testing or chemical analysis on incoming materials and chemicals. TI and TI suppliers consider certain information to be proprietary, and thus CAS numbers and other limited information may not be available for release.

In no event shall TI's liability arising out of such information exceed the total purchase price of the TI part(s) at issue in this document sold by TI to Customer on an annual basis.

## IMPORTANT NOTICE

Texas Instruments Incorporated and its subsidiaries (TI) reserve the right to make corrections, modifications, enhancements, improvements, and other changes to its products and services at any time and to discontinue any product or service without notice. Customers should obtain the latest relevant information before placing orders and should verify that such information is current and complete. All products are sold subject to TI's terms and conditions of sale supplied at the time of order acknowledgment.

TI warrants performance of its hardware products to the specifications applicable at the time of sale in accordance with TI's standard warranty. Testing and other quality control techniques are used to the extent TI deems necessary to support this warranty. Except where mandated by government requirements, testing of all parameters of each product is not necessarily performed.

TI assumes no liability for applications assistance or customer product design. Customers are responsible for their products and applications using TI components. To minimize the risks associated with customer products and applications, customers should provide adequate design and operating safeguards.

TI does not warrant or represent that any license, either express or implied, is granted under any TI patent right, copyright, mask work right, or other TI intellectual property right relating to any combination, machine, or process in which TI products or services are used. Information published by TI regarding third-party products or services does not constitute a license from TI to use such products or services or a warranty or endorsement thereof. Use of such information may require a license from a third party under the patents or other intellectual property of the third party, or a license from TI under the patents or other intellectual property of TI.

Reproduction of TI information in TI data books or data sheets is permissible only if reproduction is without alteration and is accompanied by all associated warranties, conditions, limitations, and notices. Reproduction of this information with alteration is an unfair and deceptive business practice. TI is not responsible or liable for such altered documentation. Information of third parties may be subject to additional restrictions.

Resale of TI products or services with statements different from or beyond the parameters stated by TI for that product or service voids all express and any implied warranties for the associated TI product or service and is an unfair and deceptive business practice. TI is not responsible or liable for any such statements.

TI products are not authorized for use in safety-critical applications (such as life support) where a failure of the TI product would reasonably be expected to cause severe personal injury or death, unless officers of the parties have executed an agreement specifically governing such use. Buyers represent that they have all necessary expertise in the safety and regulatory ramifications of their applications, and acknowledge and agree that they are solely responsible for all legal, regulatory and safety-related requirements concerning their products and any use of TI products in such safety-critical applications, notwithstanding any applications-related information or support that may be provided by TI. Further, Buyers must fully indemnify TI and its representatives against any damages arising out of the use of TI products in such safety-critical applications.

TI products are neither designed nor intended for use in military/aerospace applications or environments unless the TI products are specifically designated by TI as military-grade or "enhanced plastic." Only products designated by TI as military-grade meet military specifications. Buyers acknowledge and agree that any such use of TI products which TI has not designated as military-grade is solely at the Buyer's risk, and that they are solely responsible for compliance with all legal and regulatory requirements in connection with such use.

TI products are neither designed nor intended for use in automotive applications or environments unless the specific TI products are designated by TI as compliant with ISO/TS 16949 requirements. Buyers acknowledge and agree that, if they use any non-designated products in automotive applications, TI will not be responsible for any failure to meet such requirements.

Following are URLs where you can obtain information on other Texas Instruments products and application solutions:

### Products

Audio	<a href="http://www.ti.com/audio">www.ti.com/audio</a>
Amplifiers	<a href="http://amplifier.ti.com">amplifier.ti.com</a>
Data Converters	<a href="http://dataconverter.ti.com">dataconverter.ti.com</a>
DLP® Products	<a href="http://www.dlp.com">www.dlp.com</a>
DSP	<a href="http://dsp.ti.com">dsp.ti.com</a>
Clocks and Timers	<a href="http://www.ti.com/clocks">www.ti.com/clocks</a>
Interface	<a href="http://interface.ti.com">interface.ti.com</a>
Logic	<a href="http://logic.ti.com">logic.ti.com</a>
Power Mgmt	<a href="http://power.ti.com">power.ti.com</a>
Microcontrollers	<a href="http://microcontroller.ti.com">microcontroller.ti.com</a>
RFID	<a href="http://www.ti-rfid.com">www.ti-rfid.com</a>
RF/IF and ZigBee® Solutions	<a href="http://www.ti.com/lprf">www.ti.com/lprf</a>

### Applications

Communications and Telecom	<a href="http://www.ti.com/communications">www.ti.com/communications</a>
Computers and Peripherals	<a href="http://www.ti.com/computers">www.ti.com/computers</a>
Consumer Electronics	<a href="http://www.ti.com/consumer-apps">www.ti.com/consumer-apps</a>
Energy and Lighting	<a href="http://www.ti.com/energy">www.ti.com/energy</a>
Industrial	<a href="http://www.ti.com/industrial">www.ti.com/industrial</a>
Medical	<a href="http://www.ti.com/medical">www.ti.com/medical</a>
Security	<a href="http://www.ti.com/security">www.ti.com/security</a>
Space, Avionics and Defense	<a href="http://www.ti.com/space-avionics-defense">www.ti.com/space-avionics-defense</a>
Transportation and Automotive	<a href="http://www.ti.com/automotive">www.ti.com/automotive</a>
Video and Imaging	<a href="http://www.ti.com/video">www.ti.com/video</a>
Wireless	<a href="http://www.ti.com/wireless-apps">www.ti.com/wireless-apps</a>

TI E2E Community Home Page

[e2e.ti.com](http://e2e.ti.com)

Mailing Address: Texas Instruments, Post Office Box 655303, Dallas, Texas 75265  
Copyright © 2011, Texas Instruments Incorporated