

.020" [0.50] CENTERLINE
 .031" [0.80] CENTERLINE
 .039" [1.00] CENTERLINE
 .049" [1.25] CENTERLINE

PCA SERIES

INTRODUCTION:

Adam Tech PCA Series Flexible Printed Circuit (FPC) and Flexible Flat Cable (FFC) connectors are ZIF (zero insertion force) connectors designed to provide a fast, easy, reliable method to make a connection of flexible printed circuits to a PCB. Adam Tech's special contact design completely preserves conductor integrity by eliminating all wiping action while making connection. Flex circuitry enters the connector and the connector cap is pressed down to capture the flex circuit producing a stable, high pressure connection. Raising the cap releases the pressure for exchange or replacement of circuitry. This series includes single and dual row versions in thru-hole or SMT mounting in vertical or horizontal orientations.

FEATURES:

Superior contact design protects conductors
 High pressure contacts
 Single or dual row versions
 Choice of .020", .031", .039" and .049" centerlines

MATING FPC & FFC:

Mates with .020", .031", .039" and .049" centerline flat flexible circuits with thickness range of 0.1mm to 0.3mm

SPECIFICATIONS:

Material:

Standard Hi-Temp Insulator: LCP, Glass reinforced, rated UL94V-0
 Insulator color: Natural
 Contacts: Phosphor Bronze

Contact Plating:

Tin over copper underplate overall

Electrical:

Operating voltage: 100V AC max.
 Current rating: .020" Spacing: 0.4 Amps max.
 .031" & .039" Spacing: 0.5 Amps max
 .049" Spacing: 1 Amp max
 Contact resistance: 30 mΩ max. initial
 Insulation resistance: 500 MΩ min.
 Dielectric withstanding voltage: 500V AC for 1 minute

Mechanical:

Insertion Force: 0 oz max
 Withdrawal Force: 13 oz min

Temperature Rating:

Operating temperature: -40°C to +85°C
 Soldering process temperature: 260°C

PACKAGING:

Anti-ESD plastic tubes or Tape and Reel

APPROVALS AND CERTIFICATIONS:

UL Recognized File No. E224053
 CSA Certified File No. LR1578596

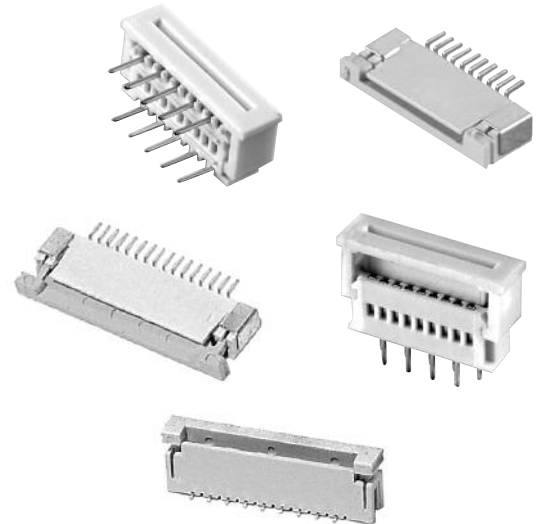

ORDERING INFORMATION

PCA	1	10	V	3	20
SERIES INDICATOR PCA = ZIF Flex Circuit Connector			ENTRY ANGLE V = Top entry HL = Side entry, lower contact HU = Side entry, upper contact		PCB ROW SPACING 20 = 2.0mm Leave blank for SMT
		POSITIONS 03 thru 30		FLEX CIRCUIT THICKNESS 3 = 0.1mm thru 0.3mm (standard for all types)	
TYPE	1 = .049" centerline thru-hole 2 = .039" centerline SMT (body height 2.0mm) 2A = .039" centerline SMT (body height 1.5mm) 2B = .039" centerline SMT (body height 1.2mm) 3 = .039" centerline thru-hole 4 = .049" centerline SMT 5 = .031" centerline SMT 6 = .020" centerline SMT (body height 2.0mm) 6A = .020" centerline SMT (body height 1.5mm) 6B = .020" centerline SMT (body height 1.2mm) 6C = .020" centerline SMT (body height 1.0mm) 7 = .012" centerline SMT				

OPTIONS:

Add designator(s) to end of part number
 TR = Tape and reel packaging

CONTACT SECTION VIEWS



UPPER CONTACT



LOWER CONTACT

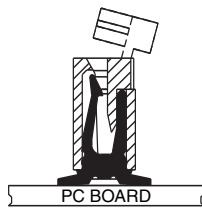

VERTICAL MOUNT

PCA-6

.020" (0.5) SIDE ENTRY SMT



PCA-6-16-HU-3

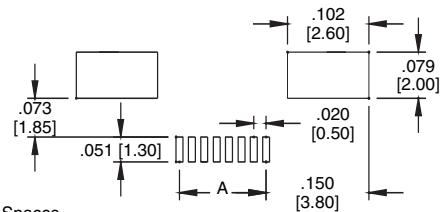
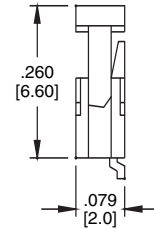
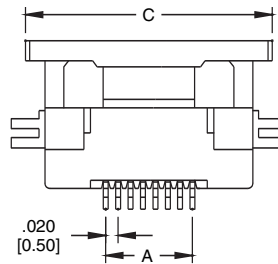
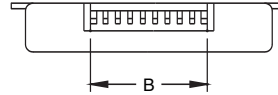

A = .020 [0.50] X No. of Spaces
 B = A + .045 [1.14]
 C = A + .189 [6.60]

Recommended PCB Layout

PCA-6

.020" (0.5) TOP ENTRY SMT



PCA-6-18-V-3

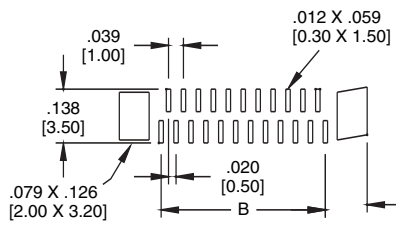
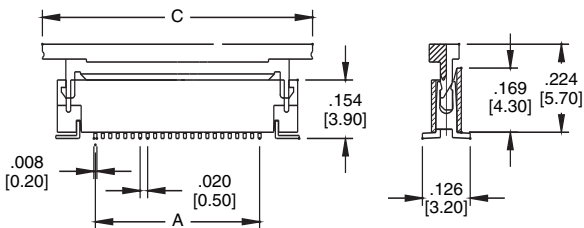
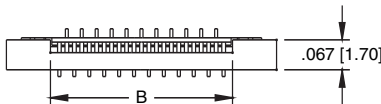

A = .020 [0.50] X No. of Spaces
 B = A + .045 [1.14]
 C = A + .189 [6.60]

Recommended PCB Layout

PCA-5

.031" (0.8) SIDE ENTRY SMT



PCA-5-24-HU-3

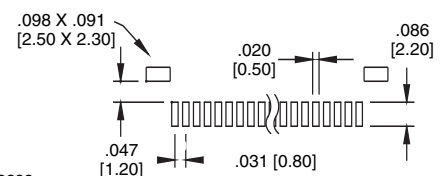
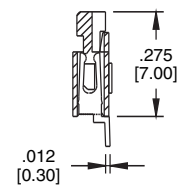
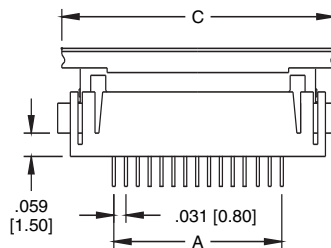
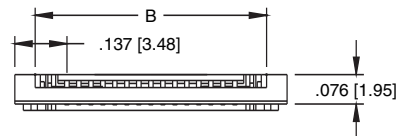

A = .031 [0.80] X No. of Spaces
 B = A + .081 [2.05]
 C = A + .228 [5.80]

Recommended PCB Layout

PCA-2
.039" (1.00) SIDE ENTRY SMT

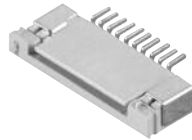

PCA-2-10-HU-3

Also Available in 1.2mm & 1.5mm Body heights

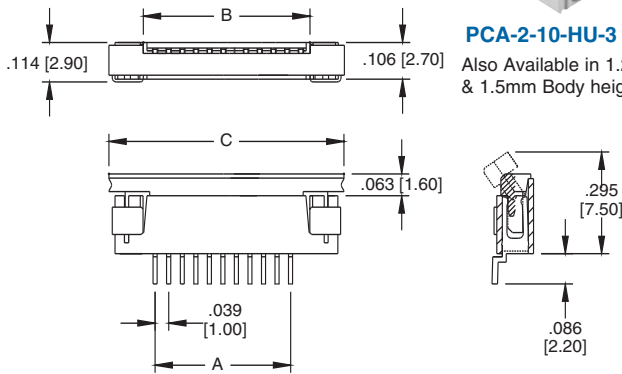

A = .039 [1.00] X No. of Spaces
B = A + .090 [2.30]
C = A + .280 [7.10]

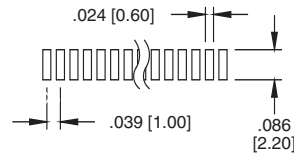

Recommended PCB Layout

PCA-2
.039" (1.00) TOP ENTRY SMT

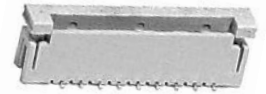

PCA-2-18-V-3

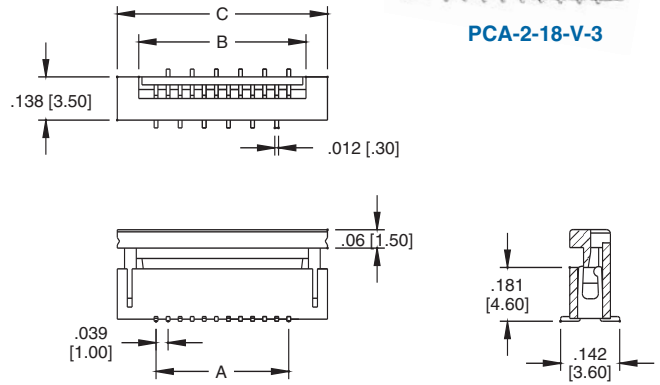

A = .039 [1.00] X No. of Spaces
B = A + .090 [2.30]
C = A + .280 [7.10]

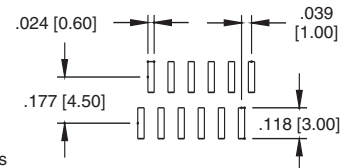

Recommended PCB Layout

PCA-1
.049" (1.25) TOP ENTRY THRU HOLE

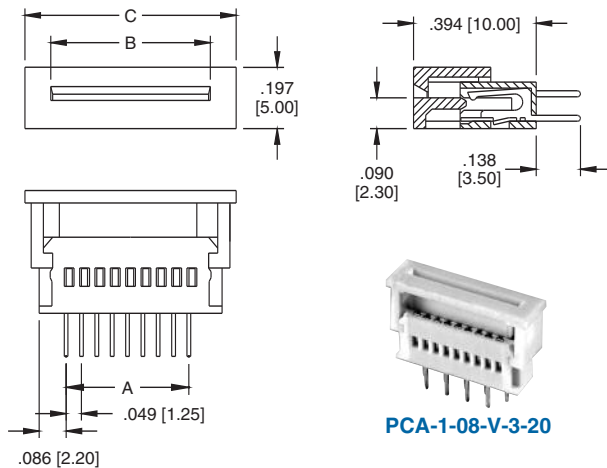

PCA-1-08-V-3-20

A = .049 [1.25] X No. of Spaces
B = A + .106 [2.70]
C = A + .303 [7.70]

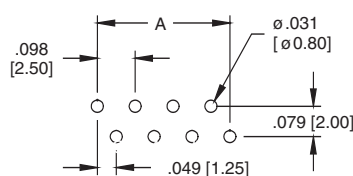

Recommended PCB Layout

PCA-1
.049" (1.25) SIDE ENTRY THRU HOLE

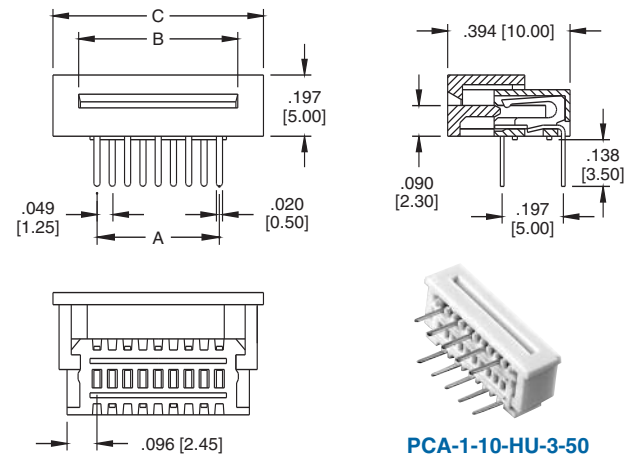

PCA-1-10-HU-3-50

A = .049 [1.25] X No. of Spaces
B = A + .106 [2.70]
C = A + .303 [7.70]

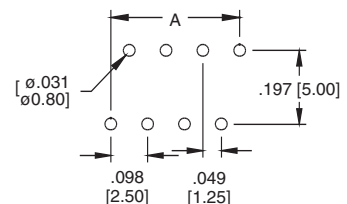

Recommended PCB Layout