

## LP5952 350-mA Dual-Rail Linear Regulator

### 1 Features

- Input Voltage Range: 0.7 V to 4.5 V
- $2.5\text{ V} \leq V_{\text{BATT}} \leq 5.5\text{ V}$
- $0.5\text{ V} \leq V_{\text{OUT}} \leq 2\text{ V}$
- Ensured 350-mA Output Current
- For  $I_{\text{LOAD}} = 350\text{ mA}$ :
  - $V_{\text{BATT}} \geq V_{\text{OUT(NOM)}} + 1.5\text{ V}$  or  $2.5\text{ V}$  (Whichever is Higher)
- For  $I_{\text{LOAD}} = 150\text{ mA}$ :
  - $V_{\text{BATT}} \geq V_{\text{OUT(NOM)}} + 1.3\text{ V}$  or  $2.5\text{ V}$  (Whichever is Higher)
- Excellent Load Transient Response:  $\pm 15\text{ mV}$  Typical
- Excellent Line Transient Response:  $\pm 1\text{ mV}$  Typical
- 50- $\mu\text{A}$  Typical Quiescent Current from  $V_{\text{BATT}}$
- 10- $\mu\text{A}$  Typical Quiescent Current from  $V_{\text{IN}}$
- 0.1- $\mu\text{A}$  Typical Quiescent Current in Shutdown
- Noise voltage = 100  $\mu\text{V}_{\text{RMS}}$  Typical
- Operates from a Single Li-Ion Cell or 3-Cell NiMH/NiCd Battery
- Thermal-Overload and Short-Circuit Protection

### 2 Applications

- Mobile Phones
- Hand-Held Radios
- Personal Digital Assistants
- Palm-Top PCs
- Portable Instruments
- Battery-Powered Devices

### 3 Description

The LP5952 is a dual-supply-rail linear regulator optimized for powering ultralow-voltage circuits from a single Li-Ion cell or 3-cell NiMH/NiCd battery.

In the typical post-regulation application  $V_{\text{BATT}}$  is directly connected to the battery (range 2.5 V to 5.5 V), and  $V_{\text{IN}}$  is supplied by the output voltage of the DC-DC converter (range 0.7 V to 4.5 V).

The device offers superior dropout and transient features combined with very low quiescent currents. In shutdown mode (Enable (EN) pin pulled low) the device turns off and reduces battery consumption to 0.1  $\mu\text{A}$  (typical). The LP5952 also features internal protection against overtemperature, overcurrent, and undervoltage conditions.

Depending upon application, only one or two tiny surface-mount external components are required; performance is specified for a  $-40^{\circ}\text{C}$  to  $+125^{\circ}\text{C}$  junction temperature range. The device is available in fixed output voltages from 0.5 V to 2 V. For availability, please contact your local Texas Instruments sales office.

#### Device Information<sup>(1)</sup>

PART NUMBER	PACKAGE	BODY SIZE (NOM)
LP5952	DSBGA (5)	1.326 mm × 0.96 mm
	USON (6)	2.00 mm × 2.00 mm

(1) For all available packages, see the orderable addendum at the end of the data sheet.

#### Typical Application Circuit

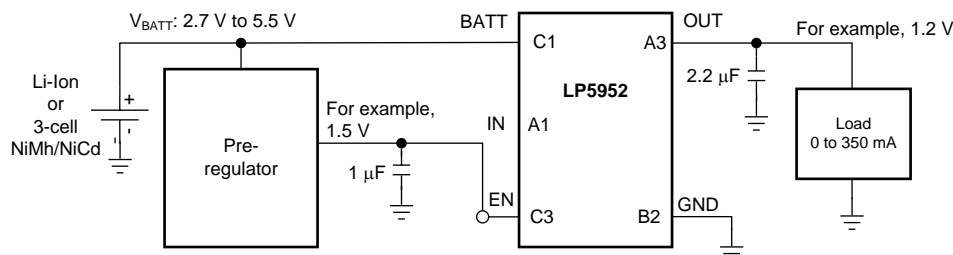

## Table of Contents

<b>1 Features</b> .....	<b>1</b>	7.1 Overview .....	<b>10</b>
<b>2 Applications</b> .....	<b>1</b>	7.2 Functional Block Diagram .....	<b>10</b>
<b>3 Description</b> .....	<b>1</b>	7.3 Feature Description .....	<b>10</b>
<b>4 Revision History</b> .....	<b>2</b>	7.4 Device Functional Modes .....	<b>11</b>
<b>5 Pin Configuration and Functions</b> .....	<b>3</b>	<b>8 Application and Implementation</b> .....	<b>12</b>
<b>6 Specifications</b> .....	<b>4</b>	8.1 Application Information .....	<b>12</b>
6.1 Absolute Maximum Ratings .....	<b>4</b>	8.2 Typical Application .....	<b>12</b>
6.2 ESD Ratings .....	<b>4</b>	<b>9 Power Supply Recommendations</b> .....	<b>17</b>
6.3 Recommended Operating Conditions .....	<b>4</b>	<b>10 Layout</b> .....	<b>18</b>
6.4 Thermal Information .....	<b>5</b>	10.1 Layout Guidelines .....	<b>18</b>
6.5 Electrical Characteristics .....	<b>5</b>	10.2 Layout Examples .....	<b>18</b>
6.6 Electrical Characteristics: Quiescent Currents .....	<b>6</b>	<b>11 Device and Documentation Support</b> .....	<b>19</b>
6.7 Electrical Characteristics: Shutdown Currents .....	<b>6</b>	11.1 Device Support .....	<b>19</b>
6.8 Electrical Characteristics: Enable Control .....	<b>6</b>	11.2 Documentation Support .....	<b>19</b>
6.9 Electrical Characteristics: Thermal Protection .....	<b>7</b>	11.3 Community Resources .....	<b>19</b>
6.10 Electrical Characteristics: Transient Characteristics .....	<b>7</b>	11.4 Trademarks .....	<b>19</b>
6.11 Input and Output Capacitors (Recommended) .....	<b>7</b>	11.5 Electrostatic Discharge Caution .....	<b>19</b>
6.12 Typical Characteristics .....	<b>8</b>	11.6 Glossary .....	<b>19</b>
<b>7 Detailed Description</b> .....	<b>10</b>	<b>12 Mechanical, Packaging, and Orderable Information</b> .....	<b>19</b>

## 4 Revision History

NOTE: Page numbers for previous revisions may differ from page numbers in the current version.

<b>Changes from Revision E (May 2013) to Revision F</b>	<b>Page</b>
• Added <i>Device Information</i> and <i>Pin Configuration and Functions</i> sections, <i>ESD Ratings</i> and <i>Thermal Information</i> tables, <i>Feature Description</i> , <i>Device Functional Modes</i> , <i>Application and Implementation</i> , <i>Power Supply Recommendations</i> , <i>Layout</i> , <i>Device and Documentation Support</i> , and <i>Mechanical, Packaging, and Orderable Information</i> sections; update pin names to TI nomenclature .....	<b>1</b>
• Deleted lead temp spec - it is in POA .....	<b>4</b>
• Updated thermal information .....	<b>5</b>
• Changed values for thermal specifications in <i>Power Dissipation</i> section per updated thermal information .....	<b>14</b>

<b>Changes from Revision D (April 2013) to Revision E</b>	<b>Page</b>
• Changed layout of National Data Sheet to TI format .....	<b>18</b>

## 5 Pin Configuration and Functions

**YZR Package  
5-Pin DSBGA  
Top View**

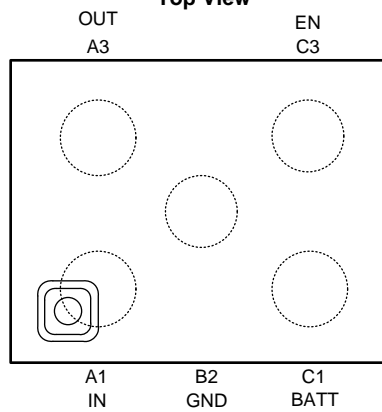

NC - No internal connection

**NKH Package  
6-Pin USON  
Top View**

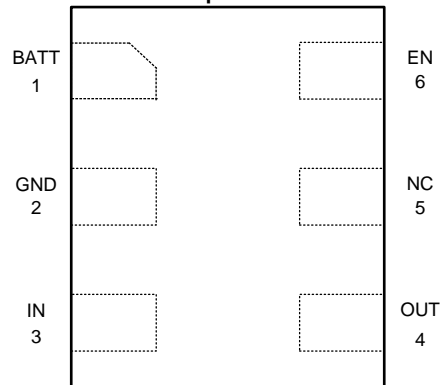

### Pin Functions

PIN			TYPE	DESCRIPTION
NAME	USON	DSGBA		
BATT	1	C1	Input	Bias input voltage; input range: 2.5 V to 5.5 V
EN	6	C3	Input	Enable pin logic input: low = shutdown, high = active, normal operation. This pin should not be left floating. Tie to BATT if this function is not used.
GND	2	B2	Ground	Ground
IN	3	A1	Input	Power input voltage; input range: 0.7 V to 4.5 V, $V_{IN} \leq V_{BATT}$
NC	5	—	—	Do not make connections to this pin.
OUT	4	A3	Output	Regulated output voltage

## 6 Specifications

### 6.1 Absolute Maximum Ratings

over operating free-air temperature range (unless otherwise noted)<sup>(1)(2)(3)</sup>

	MIN	MAX	UNIT
IN, BATT pins: Voltage to GND, $V_{IN} \leq V_{BATT}$	-0.2		V
BATT pin to IN pin		0.2	V
EN pin, voltage to GND	-0.2		V
Continuous power dissipation <sup>(4)</sup>	Internally limited		
Junction Temperature ( $T_{J-MAX}$ )		150	°C
Storage temperature, $T_{stg}$	-65	150	°C

- (1) Stresses beyond those listed under *Absolute Maximum Ratings* may cause permanent damage to the device. These are stress ratings only, which do not imply functional operation of the device at these or any other conditions beyond those indicated under *Recommended Operating Conditions*. Exposure to absolute-maximum-rated conditions for extended periods may affect device reliability.
- (2) All voltages are with respect to the potential at the GND pin.
- (3) If Military or Aerospace specified devices are required, contact Texas Instruments Sales Office or Distributors for availability and specifications.
- (4) Internal thermal shutdown circuitry protects the device from permanent damage. Thermal shutdown engages at  $T_J = 165^\circ\text{C}$  (typical) and disengages at  $T_J = 145^\circ\text{C}$  (typical).

### 6.2 ESD Ratings

		VALUE	UNIT
$V_{(ESD)}$ Electrostatic discharge	Human-body model (HBM), per ANSI/ESDA/JEDEC JS-001 <sup>(1)</sup>	±2000	V
	Machine model	±200	

- (1) JEDEC document JEP155 states that 500-V HBM allows safe manufacturing with a standard ESD control process.

### 6.3 Recommended Operating Conditions

over operating free-air temperature range (unless otherwise noted)

	MIN	MAX	UNIT
Input voltage, $V_{IN}$	0.7	4.5	V
Input voltage, $V_{BATT}$	2.5	5.5	V
Input voltage, $V_{EN}$	0	$V_{BATT}$	V
Recommended load current	0	350	mA
Junction temperature, $T_J$	-40	125	°C
Ambient temperature, $T_A$ <sup>(1)</sup>	-40	85	°C

- (1) In applications where high power dissipation and/or poor package thermal resistance is present, the maximum ambient temperature may have to be derated. Maximum ambient temperature ( $T_{A-MAX}$ ) is dependent on the maximum operating junction temperature ( $T_{J-MAX-OP} = 125^\circ\text{C}$ ), the maximum power dissipation of the device in the application ( $P_{D-MAX}$ ), and the junction-to ambient thermal resistance of the part/package in the application ( $R_{\theta JA}$ ), as given by:  $T_{A-MAX} = T_{J-MAX-OP} - (R_{\theta JA} \times P_{D-MAX})$ .

## 6.4 Thermal Information

THERMAL METRIC <sup>(1)</sup>		LP5952		UNIT
		YZR (DSBGA)	NKH (USON)	
		5 PINS	6 PINS	
R <sub>θJA</sub>	Junction-to-ambient thermal resistance <sup>(2)</sup>	181.0	181.6	°C/W
R <sub>θJC(top)</sub>	Junction-to-case (top) thermal resistance	0.9	93.1	°C/W
R <sub>θJB</sub>	Junction-to-board thermal resistance	110.3	116.7	°C/W
ψ <sub>JT</sub>	Junction-to-top characterization parameter	7.4	8.0	°C/W
ψ <sub>JB</sub>	Junction-to-board characterization parameter	110.3	116.7	°C/W

- (1) For more information about traditional and new thermal metrics, see the *Semiconductor and IC Package Thermal Metrics* application report, [SPRA953](#).
- (2) Junction-to-ambient thermal resistance is highly application and board-layout dependent. In applications where high maximum power dissipation exists, special attention must be paid to thermal dissipation issues in board design.

## 6.5 Electrical Characteristics

Unless otherwise noted, typical values are for T<sub>A</sub> = 25°C, and minimum and maximum limits apply over the full operating temperature range: –40°C ≤ T<sub>J</sub> ≤ +125°C; specifications apply to the *Typical Application Circuit* with V<sub>IN</sub> = V<sub>OUT(NOM)</sub> + 1 V, V<sub>BATT</sub> = V<sub>OUT(NOM)</sub> + 1.5 V or 2.5 V (whichever is higher), I<sub>OUT</sub> = 1 mA, C<sub>VIN</sub> = 1 μF, C<sub>OUT</sub> = 2.2 μF, V<sub>EN</sub> = V<sub>BATT</sub>.<sup>(1)(2)(3)</sup>

PARAMETER	TEST CONDITIONS	MIN	TYP	MAX	UNIT
ΔV <sub>OUT</sub> / V <sub>OUT</sub> Output voltage tolerance	V <sub>IN</sub> = V <sub>OUT(NOM)</sub> + 0.3 V, T <sub>A</sub> = 25°C	–1.5		1.5	
	V <sub>IN</sub> = V <sub>OUT(NOM)</sub> + 0.3 V	2		2	
ΔV <sub>OUT</sub> / ΔV <sub>IN</sub> Line regulation error	V <sub>IN</sub> = V <sub>OUT(NOM)</sub> + 0.3 V to 4.5 V, V <sub>BATT</sub> = 4.5 V	1	0.3	1	mV/V
	V <sub>BATT</sub> = V <sub>OUT(NOM)</sub> + 1.5 V (≥ 2.5 V) to 5.5 V	2.2	0.5	2.2	
ΔV <sub>OUT</sub> / ΔmA    Load regulation error	I <sub>OUT</sub> = 1 mA to 350 mA    DSBGA package	30	15	30	μV/mA
	I <sub>OUT</sub> = 1 mA to 350 mA    USON package	60	43	60	μV/mA
I <sub>SC</sub> Output current (short circuit)	V <sub>OUT</sub> = 0 V, V <sub>EN</sub> = V <sub>IN</sub> = V <sub>BATT</sub> = V <sub>OUT(NOM)</sub> + 1.5 V	350	500		mA
V <sub>DO_VBATT</sub> <sup>(4)</sup> Output voltage dropout V <sub>BATT</sub> <sup>(5)</sup>	I <sub>OUT</sub> = 350 mA, V <sub>IN</sub> = V <sub>OUT(NOM)</sub> + 0.3 V    DSBGA package		1.07	1.5	V
	I <sub>OUT</sub> = 350 mA, V <sub>IN</sub> = V <sub>OUT(NOM)</sub> + 0.3 V    USON package		1.08	1.5	V
	I <sub>OUT</sub> = 150 mA, V <sub>IN</sub> = V <sub>OUT(NOM)</sub> + 0.3 V    DSBGA package		0.96	1.3	V
	I <sub>OUT</sub> = 150 mA, V <sub>IN</sub> = V <sub>OUT(NOM)</sub> + 0.3 V    USON package		0.97	1.3	V
V <sub>DO_VIN</sub> Output voltage dropout V <sub>IN</sub>	I <sub>OUT</sub> = 350 mA, V <sub>BATT</sub> = V <sub>OUT(NOM)</sub> + 1.5 V or 2.5 V    DSBGA package		88	200	mV
	I <sub>OUT</sub> = 350 mA, V <sub>BATT</sub> = V <sub>OUT(NOM)</sub> + 1.5 V or 2.5 V    USON package		128	250	mV
E <sub>N</sub> Output noise	10 Hz to 100 kHz		100		μV <sub>RMS</sub>

- (1) All voltages are with respect to the potential at the GND pin.
- (2) Minimum and maximum limits are ensured by design, test, or statistical analysis. Typical numbers are not ensured, but do represent the most likely norm. Unless otherwise specified, conditions for typical specifications are: V<sub>IN</sub> = V<sub>OUT(NOM)</sub> + 1 V, V<sub>BATT</sub> = V<sub>OUT(NOM)</sub> + 1.5 V or 2.5 V, whichever is higher, T<sub>A</sub> = 25°C.
- (3) V<sub>OUT(NOM)</sub> is the stated output voltage option.
- (4) This specification does not apply if the battery voltage V<sub>BATT</sub> needs to be decreased below the minimum operating limit of 2.5 V during this test.
- (5) Dropout voltage is defined as the input to output voltage differential at which the output voltage falls to 100mV below the nominal output voltage.

### Electrical Characteristics (continued)

Unless otherwise noted, typical values are for  $T_A = 25^\circ\text{C}$ , and minimum and maximum limits apply over the full operating temperature range:  $-40^\circ\text{C} \leq T_J \leq +125^\circ\text{C}$ ; specifications apply to the *Typical Application Circuit* with  $V_{IN} = V_{OUT(NOM)} + 1\text{ V}$ ,  $V_{BATT} = V_{OUT(NOM)} + 1.5\text{ V}$  or  $2.5\text{ V}$  (whichever is higher),  $I_{OUT} = 1\text{ mA}$ ,  $C_{VIN} = 1\text{ }\mu\text{F}$ ,  $C_{OUT} = 2.2\text{ }\mu\text{F}$ ,  $V_{EN} = V_{BATT}$ .<sup>(1)(2)(3)</sup>

PARAMETER		TEST CONDITIONS	MIN	TYP	MAX	UNIT
PSRR	Power Supply Rejection Ratio	Sine modulated $V_{BATT}$ , $f = 10\text{ Hz}$		70		dB
		Sine modulated $V_{BATT}$ , $f = 100\text{ Hz}$		65		
		Sine modulated $V_{BATT}$ , $f = 1\text{ kHz}$		45		
PSRR	Power Supply Rejection Ratio	Sine modulated $V_{IN}$ , $f = 10\text{ Hz}$		80		dB
		Sine modulated $V_{IN}$ , $f = 100\text{ Hz}$		90		
		Sine modulated $V_{IN}$ , $f = 1\text{ kHz}$		95		
		Sine modulated $V_{IN}$ , $f = 10\text{ kHz}$		85		
		Sine modulated $V_{IN}$ , $f = 100\text{ kHz}$		64		

### 6.6 Electrical Characteristics: Quiescent Currents

Unless otherwise noted, typical values are for  $T_A = 25^\circ\text{C}$ , and minimum and maximum limits apply over the full operating temperature range:  $-40^\circ\text{C} \leq T_J \leq +125^\circ\text{C}$ .<sup>(1)(2)(3)</sup>

PARAMETER		TEST CONDITIONS	MIN	TYP	MAX	UNIT
$I_{Q\_VBATT}$	Current into $V_{BATT}$	$I_{LOAD} = 0\text{ mA}$ to $350\text{ mA}$		50	100	$\mu\text{A}$
$I_{Q\_VIN}$	Current into $V_{IN}$	$I_{LOAD} = 0$		11	28	$\mu\text{A}$

- (1) All voltages are with respect to the potential at the GND pin.
- (2) Minimum and maximum limits are ensured by design, test, or statistical analysis. Typical numbers are not ensured, but do represent the most likely norm. Unless otherwise specified, conditions for typical specifications are:  $V_{IN} = V_{OUT(NOM)} + 1\text{ V}$ ,  $V_{BATT} = V_{OUT(NOM)} + 1.5\text{ V}$  or  $2.5\text{ V}$ , whichever is higher,  $T_A = 25^\circ\text{C}$ .
- (3)  $V_{OUT(NOM)}$  is the stated output voltage option

### 6.7 Electrical Characteristics: Shutdown Currents

Unless otherwise noted, typical values are for  $T_A = 25^\circ\text{C}$ , and minimum and maximum limits apply over the full operating temperature range:  $-40^\circ\text{C} \leq T_J \leq +125^\circ\text{C}$ .<sup>(1)(2)(3)</sup>

PARAMETER		TEST CONDITIONS	MIN	TYP	MAX	UNIT
$I_{Q\_VBATT}$	Current into $V_{BATT}$	$V_{EN} = 0\text{ V}$		0.1	1	$\mu\text{A}$
$I_{Q\_VIN}$	Current into $V_{IN}$	$V_{EN} = 0\text{ V}$		0.1	1	$\mu\text{A}$

- (1) All voltages are with respect to the potential at the GND pin.
- (2) Minimum and maximum limits are ensured by design, test, or statistical analysis. Typical numbers are not ensured, but do represent the most likely norm. Unless otherwise specified, conditions for typical specifications are:  $V_{IN} = V_{OUT(NOM)} + 1\text{ V}$ ,  $V_{BATT} = V_{OUT(NOM)} + 1.5\text{ V}$  or  $2.5\text{ V}$ , whichever is higher,  $T_A = 25^\circ\text{C}$ .
- (3)  $V_{OUT(NOM)}$  is the stated output voltage option.

### 6.8 Electrical Characteristics: Enable Control

Unless otherwise noted, typical values are for  $T_A = 25^\circ\text{C}$ , and minimum and maximum limits apply over the full operating temperature range:  $-40^\circ\text{C} \leq T_J \leq +125^\circ\text{C}$ .<sup>(1)(2)(3)</sup>

PARAMETER		TEST CONDITIONS	MIN	TYP	MAX	UNIT
$I_{EN}$	Maximum input current at EN input			0.01	1	$\mu\text{A}$
$V_{IL}$	Low input threshold (shutdown)				0.4	V
$V_{IH}$	High input threshold (enable)		1			V

- (1) All voltages are with respect to the potential at the GND pin.
- (2) Minimum and maximum limits are ensured by design, test, or statistical analysis. Typical numbers are not ensured, but do represent the most likely norm. Unless otherwise specified, conditions for typical specifications are:  $V_{IN} = V_{OUT(NOM)} + 1\text{ V}$ ,  $V_{BATT} = V_{OUT(NOM)} + 1.5\text{ V}$  or  $2.5\text{ V}$ , whichever is higher,  $T_A = 25^\circ\text{C}$ .
- (3)  $V_{OUT(NOM)}$  is the stated output voltage option.

## 6.9 Electrical Characteristics: Thermal Protection

Typical values are for  $T_A = 25^\circ\text{C}$ .<sup>(1)(2)(3)</sup>

PARAMETER		TEST CONDITIONS	MIN	TYP	MAX	UNIT
$T_{\text{SHDN}}$	Thermal-shutdown temperature			165		$^\circ\text{C}$
$\Delta T_{\text{SHDN}}$	Thermal-shutdown hysteresis			20		$^\circ\text{C}$

- (1) All voltages are with respect to the potential at the GND pin.
- (2) Minimum and maximum limits are ensured by design, test, or statistical analysis. Typical numbers are not ensured, but do represent the most likely norm. Unless otherwise specified, conditions for typical specifications are:  $V_{\text{IN}} = V_{\text{OUT(NOM)}} + 1\text{ V}$ ,  $V_{\text{BATT}} = V_{\text{OUT(NOM)}} + 1.5\text{ V}$  or  $2.5\text{ V}$ , whichever is higher,  $T_A = 25^\circ\text{C}$ .
- (3)  $V_{\text{OUT(NOM)}}$  is the stated output voltage option.

## 6.10 Electrical Characteristics: Transient Characteristics

Unless otherwise noted, typical values are for  $T_A = 25^\circ\text{C}$ , and minimum and maximum limits apply over the full operating temperature range:  $-40^\circ\text{C} \leq T_J \leq +125^\circ\text{C}$ .<sup>(1)(2)(3)</sup>

PARAMETER		TEST CONDITIONS	MIN	TYP	MAX	UNIT
$\Delta V_{\text{OUT}}$	Dynamic line transient response $V_{\text{IN}}$	$V_{\text{IN}} = V_{\text{OUT(NOM)}} + 0.3\text{ V}$ to $V_{\text{OUT(NOM)}} + 0.9\text{ V}$ ; tr, tf = $10\ \mu\text{s}$		$\pm 1$		mV
$\Delta V_{\text{OUT}}$	Dynamic line transient response $V_{\text{BATT}}$	$V_{\text{BATT}} = V_{\text{OUT(NOM)}} + 1.5\text{ V}$ to $V_{\text{OUT(NOM)}} + 2.1\text{ V}$ ; tr, tf = $10\ \mu\text{s}$		$\pm 15$		mV
$\Delta V_{\text{OUT}}$	Dynamic load transient response	Pulsed load 0 ...300 mA, di/dt = $300\text{ mA}/1\ \mu\text{s}$	DSBGA package	$\pm 15$		mV
		Pulsed load 0 ...300mA, di/dt = $300\text{ mA}/1\ \mu\text{s}$	USON package	$-35/+15$		mV
$T_{\text{STARTUP}}$	Start-up time	EN to $0.95 \times V_{\text{OUT}}$		70	150	$\mu\text{s}$

- (1) All voltages are with respect to the potential at the GND pin.
- (2) Minimum and maximum limits are ensured by design, test, or statistical analysis. Typical numbers are not ensured, but do represent the most likely norm. Unless otherwise specified, conditions for typical specifications are:  $V_{\text{IN}} = V_{\text{OUT(NOM)}} + 1\text{ V}$ ,  $V_{\text{BATT}} = V_{\text{OUT(NOM)}} + 1.5\text{ V}$  or  $2.5\text{ V}$ , whichever is higher,  $T_A = 25^\circ\text{C}$ .
- (3)  $V_{\text{OUT(NOM)}}$  is the stated output voltage option.

## 6.11 Input and Output Capacitors (Recommended)

All values are for  $T_A = 25^\circ\text{C}$ .<sup>(1)(2)(3)</sup>

PARAMETER		TEST CONDITIONS	MIN	TYP	MAX	UNIT
$C_{\text{OUT}}$	Output capacitance	Capacitance <sup>(4)</sup>	1.5	2.2	10	$\mu\text{F}$
		ESR	3		300	m $\Omega$
$C_{\text{VIN}}$	Input capacitance at $V_{\text{IN}}$	Capacitance <sup>(4)</sup> , not needed in typical post-regulation application (see <a href="#">Figure 18</a> )	0.47	1		$\mu\text{F}$
		ESR	3		300	m $\Omega$

- (1) All voltages are with respect to the potential at the GND pin.
- (2) Minimum and maximum limits are ensured by design, test, or statistical analysis. Typical numbers are not ensured, but do represent the most likely norm. Unless otherwise specified, conditions for typical specifications are:  $V_{\text{IN}} = V_{\text{OUT(NOM)}} + 1\text{ V}$ ,  $V_{\text{BATT}} = V_{\text{OUT(NOM)}} + 1.5\text{ V}$  or  $2.5\text{ V}$ , whichever is higher,  $T_A = 25^\circ\text{C}$ .
- (3)  $V_{\text{OUT(NOM)}}$  is the stated output voltage option.
- (4) The capacitor tolerance should be 30% or better over temperature. The full operating conditions for the application should be considered when selecting a suitable capacitor to ensure that the minimum value of capacitance is always met. Recommended capacitor type is X7R. However, dependent on application, X5R, Y5V, and Z5U can also be used. The shown minimum limit represents real minimum capacitance, including all tolerances and must be maintained over temperature and DC bias voltage (See [Detailed Design Procedure](#) in [Application and Implementation](#).)

### 6.12 Typical Characteristics

Unless otherwise specified,  $T_A = 25^\circ\text{C}$ ,  $C_{IN} = 1\text{-}\mu\text{F}$  ceramic,  $C_{OUT} = 2.2\text{-}\mu\text{F}$  ceramic,  $V_{IN} = V_{OUT(NOM)} + 1\text{ V}$ ,  $V_{BATT} = V_{OUT(NOM)} + 1.5\text{ V}$ , EN pin is tied to  $V_{BATT}$  (DSBGA package).

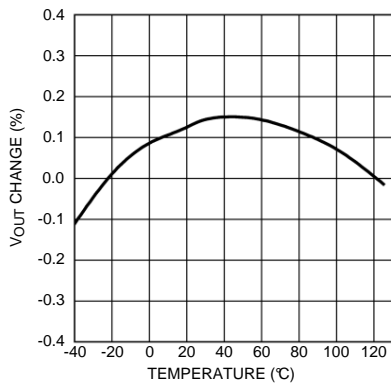
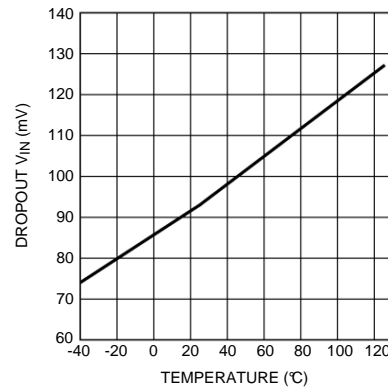
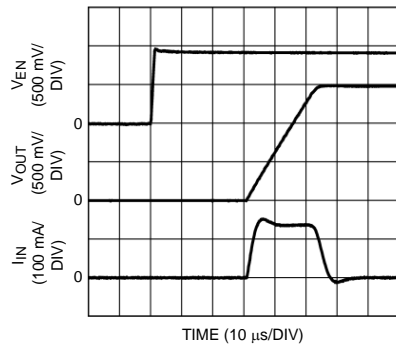

Figure 1. Output Voltage Change vs Temperature



$I_{LOAD} = 350\text{ mA}$

Figure 2. Dropout  $V_{IN}$  vs Temperature



1.5-V Option

Figure 3. Inrush Current  $V_{IN}$

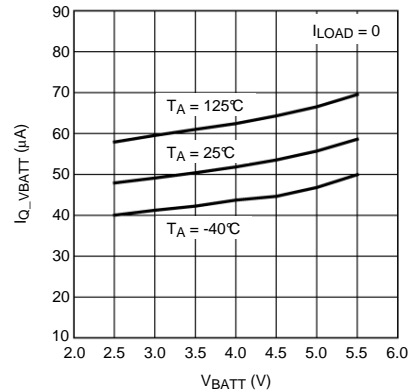

Figure 4. Quiescent Current  $I_{Q\_VBATT}$  vs  $V_{BATT}$

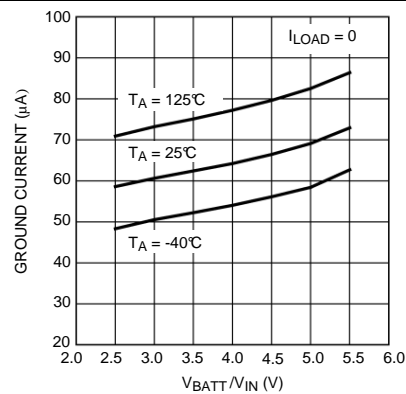

Figure 5. Ground Current vs  $V_{BATT} / V_{IN}$

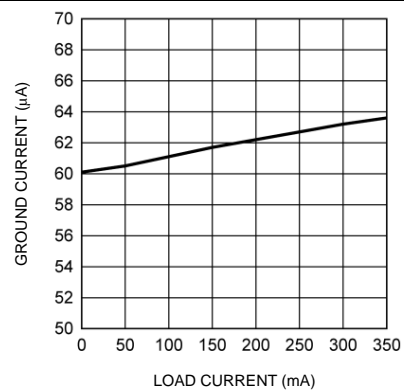
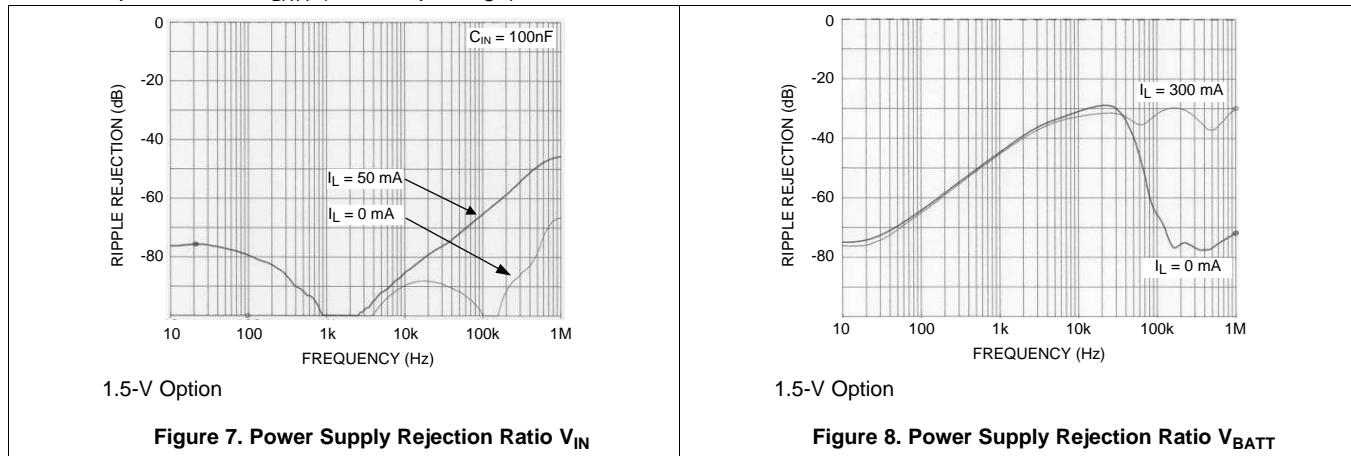

Figure 6. Ground Current vs Load Current

**Typical Characteristics (continued)**

Unless otherwise specified,  $T_A = 25^\circ\text{C}$ ,  $C_{IN} = 1\text{-}\mu\text{F}$  ceramic,  $C_{OUT} = 2.2\text{-}\mu\text{F}$  ceramic,  $V_{IN} = V_{OUT(NOM)} + 1\text{ V}$ ,  $V_{BATT} = V_{OUT(NOM)} + 1.5\text{ V}$ , EN pin is tied to  $V_{BATT}$  (DSBGA package).



## 7 Detailed Description

### 7.1 Overview

The LP5952 is a dual-supply-rail linear regulator optimized for powering ultralow-voltage circuits from a single Li-Ion cell or 3 cell NiMH/NiCd batteries. In a typical application, BATT is connected to the battery, and IN can be supplied by the output of front stage DC-DC Converter. IN does not exceed BATT at any time.

### 7.2 Functional Block Diagram

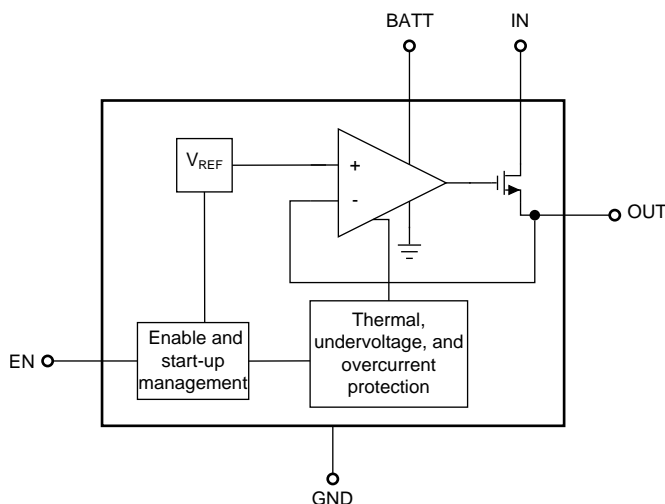

### 7.3 Feature Description

#### 7.3.1 Dual-Rail Supply

The LP5952 requires two different supply voltages:

- $V_{IN}$ , the power input voltage, is regulated to the fixed output voltage.
- $V_{BATT}$ , the bias input voltage, supplies internal circuitry.

It is important that  $V_{IN}$  does not exceed  $V_{BATT}$  at any time. If the device is used in the typical post-regulation application as shown in [Figure 18](#), the sequencing of the two power supplies is not an issue because  $V_{BATT}$  supplies both the DC-DC regulator and the LP5952 device. The output voltage of the DC-DC regulator takes some time to rise up and supply the input voltage of the device. In this application  $V_{IN}$  always ramps up more slowly than  $V_{BATT}$ .

If  $V_{IN}$  is shorted to  $V_{BATT}$ , the voltages at the two supply pins ramp up simultaneously causing no problems.

However, in applications with two independent supplies connected to the LP5952, special care must be taken to ensure that  $V_{IN}$  is always  $\leq V_{BATT}$ .

#### 7.3.2 No-Load Stability

The LP5952 remains stable and in regulation with no external load. This is an important consideration in some circuits, for example, CMOS RAM keep-alive applications.

#### 7.3.3 Fast Turnon

Fast turnon is ensured by an optimized architecture allowing a fast ramp of the output voltage to reach the target voltage while the inrush current is controlled low at 120 mA typical (for a  $C_{OUT}$  of 2.2  $\mu$ F).

## Feature Description (continued)

### 7.3.4 Short-Circuit Protection

The LP5952 is short-circuit protected and, in the event of a peak overcurrent condition, the output current through the NFET pass device is limited.

If the overcurrent condition exists for a longer time, the average power dissipation increases depending on the input-to-output voltage difference until the thermal shutdown circuitry turns the NFET off. Refer to [Power Dissipation and Device Operation](#) for power dissipation calculations.

### 7.3.5 Thermal-Overload Protection

Thermal-overload protection limits the total power dissipation in the LP5952. When the junction temperature exceeds  $T_J = 165^\circ\text{C}$  typical, the shutdown logic is triggered, and the NFET is turned off, allowing the device to cool down. After the junction temperature dropped by  $20^\circ\text{C}$  (temperature hysteresis) typical, the NFET is activated again. This results in a pulsed output voltage during continuous thermal-overload conditions.

The thermal-overload protection is designed to protect the LP5952 in the event of a fault condition. For normal continuous operation, do not exceed the absolute maximum junction temperature rating of  $T_J = 150^\circ\text{C}$  (see [Absolute Maximum Ratings](#)).

### 7.3.6 Reverse Current Path

The internal NFET pass device in LP5952 has an inherent parasitic body diode. During normal operation, the input voltage is higher than the output voltage, and the parasitic diode is reverse biased. However, if the output is pulled above the input in an application, the current flows from the output to the input as the parasitic diode gets forward biased. The output can be pulled above the input as long as the current in the parasitic diode is limited to 50 mA. For currents above this limit an external Schottky diode must be connected from  $V_{OUT}$  to  $V_{IN}$  (cathode on  $V_{IN}$ , anode on  $V_{OUT}$ ).

## 7.4 Device Functional Modes

### 7.4.1 Enable Operation

The LP5952 may be switched to an ON or OFF state by a logic input at the EN pin,  $V_{EN}$ . A logic high at this pin turns the device on. When the enable pin is low, the regulator output is off, and the device typically consumes 0.1  $\mu\text{A}$ .

If the application does not require the enable switching feature, the EN pin must be tied to  $V_{BATT}$  to keep the regulator output permanently on.

To ensure proper operation, the signal source used to drive the EN input must be able to swing above and below the specified turnon and turnoff voltage thresholds shown in  $V_{IL}$  and  $V_{IH}$  in [Electrical Characteristics: Enable Control](#).

## 8 Application and Implementation

### NOTE

Information in the following applications sections is not part of the TI component specification, and TI does not warrant its accuracy or completeness. TI's customers are responsible for determining suitability of components for their purposes. Customers should validate and test their design implementation to confirm system functionality.

### 8.1 Application Information

The LP5952 is designed to meet ultralow input-voltage application, by implementing  $V_{BATT}$  as power supply of this device. The  $V_{BATT}$  is connected to the battery (range 2.5 V to 5.5 V), the  $V_{IN}$  range can be 0.7 V to 4.5 V. The device offers superior dropout and transient features combined with very low-quiescent currents. The LP5952 delivers this performance in standard packages DSBGA and USON with an operating junction temperature ( $T_J$ ) of  $-40^{\circ}\text{C}$  to  $+125^{\circ}\text{C}$ .

### 8.2 Typical Application

#### 8.2.1 Dual-Rail Linear Regulator

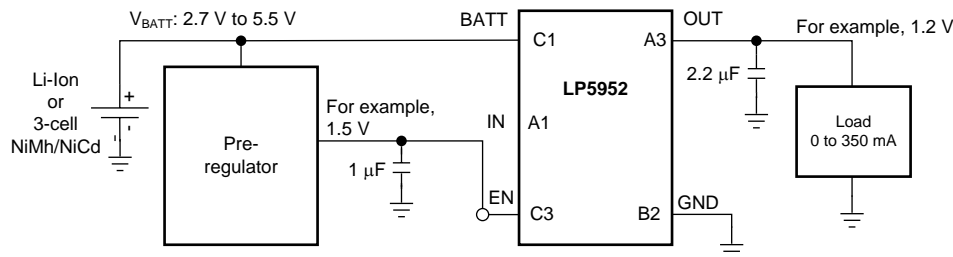

Figure 9. LP5952 Typical Application Circuit

##### 8.2.1.1 Design Requirements

For typical dual-rail linear regulator parameters, see [Table 1](#).

Table 1. Design Parameters

DESIGN PARAMETER	EXAMPLE VALUE
Input voltage range	0.7 V to 4.5 V
$V_{BATT}$ voltage range	2.7 V to 5.5 V
Output voltage	1.5 V
Output current	350 mA
Output capacitor range	2.2 $\mu\text{F}$
Input/output capacitor ESR range	3 m $\Omega$ to 300 m $\Omega$

##### 8.2.1.2 Detailed Design Procedure

###### 8.2.1.2.1 External Capacitors

As is common with most regulators, the LP5952 requires external capacitors to ensure stable operation. The LP5952 is specifically designed for portable applications requiring minimum board space and the smallest size components. These capacitors must be correctly selected for good performance.

###### 8.2.1.2.2 Input Capacitor

If the LP5952 is used as a stand-alone device, an input capacitor at  $V_{IN}$  is required for stability. It is recommended that a 1- $\mu\text{F}$  capacitor be connected between the LP5952 power voltage IN pin and ground. (This capacitance value may be increased without limit).

This capacitor must be located a distance of not more than 1 cm from the IN pin and returned to a clean analog ground. Any good quality ceramic, tantalum, or film capacitor may be used at the input.

A capacitor at  $V_{BATT}$  is not required if the distance to the supply does not exceed 5 cm.

If the device is used in the typical application as post regulator after a DC-DC regulator, no input capacitors are required — the capacitors of the DC-DC regulator ( $C_{IN}$  and  $C_{OUT}$ ) are sufficient if both components are mounted close to each other and a proper GND plane is used. If the distance between the output capacitor of the DC-DC regulator and the IN pin of the LP5952 is larger than 5 cm, adding an input capacitor at  $V_{IN}$  is recommended.

#### NOTE

**Important:** Tantalum capacitors can suffer catastrophic failures due to surge current when connected to a low-impedance source of power (like a battery or a very large capacitor). If a tantalum capacitor is used at the input, it must be ensured by the manufacturer to have a surge current rating sufficient for the application.

The equivalent series resistance (ESR) of the input capacitor should be in the range of 3 mΩ to 300 mΩ. The tolerance and temperature coefficient must be considered when selecting the capacitor to ensure the capacitance remains  $\geq 470$  nF over the entire operating temperature range.

#### 8.2.1.2.3 Output Capacitor

The LP5952 is designed specifically to work with very small ceramic output capacitors. A ceramic capacitor (dielectric types X7R, Z5U, or Y5V) in the 2.2-μF range (up to 10 μF) and with an ESR between 3 mΩ to 300 mΩ is suitable as  $C_{OUT}$  in the LP5952 application circuit.

This capacitor must be located a distance of not more than 1 cm from the OUT pin and returned to a clean analog ground.

It is also possible to use tantalum or film capacitors at the device output,  $V_{OUT}$ , but these are not as attractive for reasons of size and cost (see [Capacitor Characteristics](#)).

#### 8.2.1.2.4 Capacitor Characteristics

The LP5952 is designed to work with ceramic capacitors on the output to take advantage of the benefits they offer. For capacitance values in the 1-μF to 4.7-μF range, ceramic capacitors are the smallest, least expensive and have the lowest ESR values, thus making them best for eliminating high-frequency noise. The ESR of a typical 1-μF ceramic capacitor is in the range of 3 mΩ to 40 mΩ, which easily meets the ESR requirement for stability for the LP5952.

For both input and output capacitors, careful interpretation of the capacitor specification is required to ensure correct device operation. The capacitor value can change greatly, depending on the operating conditions and capacitor type.

In particular, the output capacitor selection must take account of all the capacitor parameters, to ensure that the specification is met within the application. The capacitance can vary with DC bias conditions as well as temperature and frequency of operation. Capacitor values show some decrease over time due to aging. The capacitor parameters are also dependant on the particular case size, with smaller sizes giving poorer performance figures in general. [Figure 10](#) shows a typical graph comparing different capacitor case sizes in a capacitance vs. DC Bias plot. As shown [Figure 10](#), increasing the DC-bias condition can result in the capacitance value falling below the minimum value given in [Input and Output Capacitors \(Recommended\)](#) (0.47 μF or 1.5 μF in this case). The graph shows the capacitance out of specification for the 0402 case size capacitor at higher bias voltages. It is therefore recommended that the capacitor-manufacturer specifications for the nominal value capacitor are consulted for all conditions, as some capacitor sizes (such as 0402) may not be suitable in the actual application.

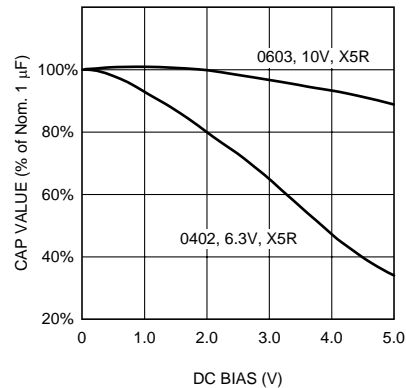

**Figure 10. Typical Variation In Capacitance vs DC Bias**

Capacitance of the ceramic capacitor can vary with temperature. The capacitor type X7R, which operates over a temperature range of  $-55^{\circ}\text{C}$  to  $+125^{\circ}\text{C}$ , only varies the capacitance to within  $\pm 15\%$ . The capacitor type X5R has a similar tolerance over a reduced temperature range of  $-55^{\circ}\text{C}$  to  $+85^{\circ}\text{C}$ . Many large value ceramic capacitors, larger than  $1\ \mu\text{F}$ , are manufactured with Z5U or Y5V temperature characteristics. Their capacitance can drop by more than 50% as the temperature varies from  $25^{\circ}\text{C}$  to  $85^{\circ}\text{C}$ . Therefore, X7R is recommended over Z5U and Y5V in applications where the ambient temperature changes significantly above or below  $25^{\circ}\text{C}$ .

Tantalum capacitors are less desirable than ceramic for use as output capacitors because they are more expensive when comparing equivalent capacitance and voltage ratings in the  $1\text{-}\mu\text{F}$  to  $4.7\text{-}\mu\text{F}$  range.

Another important consideration is that tantalum capacitors have higher ESR values than equivalent size ceramics. This means that while it may be possible to find a tantalum capacitor with an ESR value within the stable range, it would have to be larger in capacitance (which means bigger and more costly) than a ceramic capacitor with the same ESR value. The ESR of a typical tantalum increases about 2:1 as the temperature goes from  $25^{\circ}\text{C}$  down to  $-40^{\circ}\text{C}$ , so some guard band must be allowed.

#### 8.2.1.2.5 Power Dissipation and Device Operation

The permissible power dissipation for any package is a measure of the capability of the device to pass heat from the power source, the junctions of the device, to the ultimate heat sink, the ambient environment. Thus the power dissipation is dependent on the ambient temperature and the thermal resistance across the various interfaces between the die and ambient air.

As stated in the [Recommended Operating Conditions](#), the allowable power dissipation for the device in a given package can be calculated using [Equation 1](#):

$$P_D = (T_{J(\text{MAX})} - T_A) / R_{\theta\text{JA}} \quad (1)$$

With an  $R_{\theta\text{JA}} = 181^{\circ}\text{C}/\text{W}$ , the device in the 5-pin DSBGA package returns a value of 552 mW with a maximum junction temperature of  $125^{\circ}\text{C}$  at  $T_A$  of  $25^{\circ}\text{C}$  or 221 mW at  $T_A$  of  $85^{\circ}\text{C}$ .

The actual power dissipation across the device can be estimated by [Equation 2](#):

$$P_D = (V_{\text{IN}} - V_{\text{OUT}}) \times I_{\text{OUT}} \quad (2)$$

This establishes the relationship between the power dissipation allowed due to thermal consideration, the voltage drop across the device, and the continuous current capability of the device. Equation 1 and Equation 2 must be used to determine the optimum operating conditions for the device in any application. As an example, to keep full load current capability of 350 mA for a 1.5-V output voltage option at a high ambient temperature of 85°C,  $V_{IN}$  has to be kept  $\leq 2.1$  V (for DSBGA package):

$$V_{IN} \leq P_D / I_{OUT} + V_{OUT} = 221 \text{ mW} / 350 \text{ mA} + 1.5 \text{ V} = 2.1 \text{ V} \tag{3}$$

Figure 11 shows the output current derating due to these considerations:

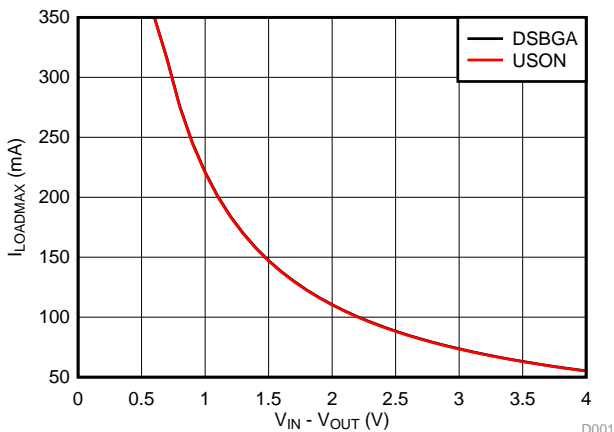

$T_A = 85^\circ\text{C}$	$V_{OUT} = 1.5 \text{ V}$
$R_{\theta JA(DSBGA)} = 181^\circ\text{C/W}$	$R_{\theta JA(USON)} = 181.6^\circ\text{C/W}$

Figure 11. Maximum Load Current vs  $V_{IN} - V_{OUT}$

The typical contribution of the bias input voltage supply  $V_{BATT}$  to the power dissipation can be neglected (Equation 4):

$$P_{D\_VBATT} = V_{BATT} \times I_{QVBATT} = 5.5 \text{ V} \times 50 \mu\text{A} = 0.275 \text{ mW typical} \tag{4}$$

8.2.1.3 Application Curves

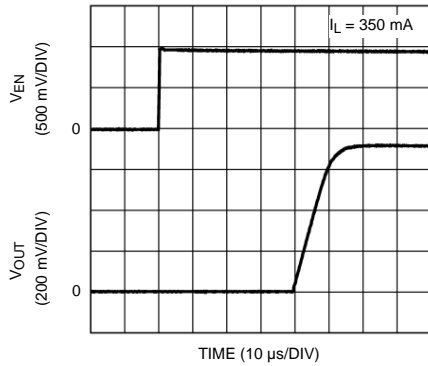

0.7-V Option

Figure 12. Enable Start-Up Time

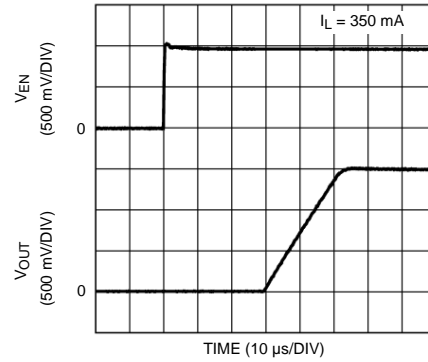

1.5-V Option

Figure 13. Enable Start-Up Time

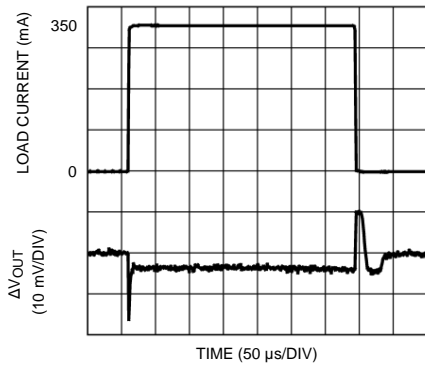

0.7-V Option

Figure 14. Load Transient Response

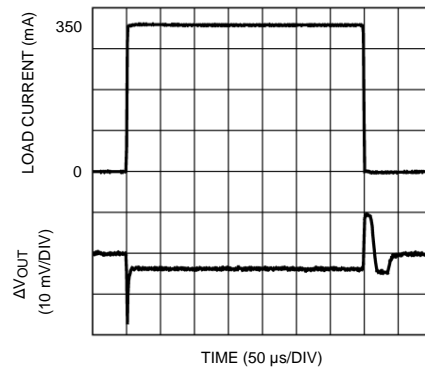

1.5-V Option

Figure 15. Load Transient Response

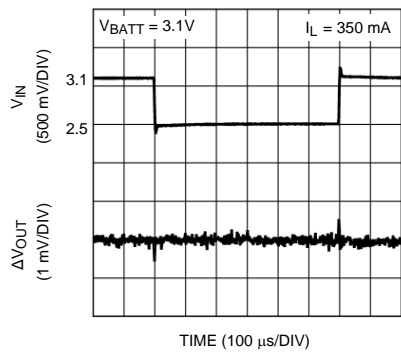

1.5-V Option

Figure 16. Line Transient Response  $V_{IN}$

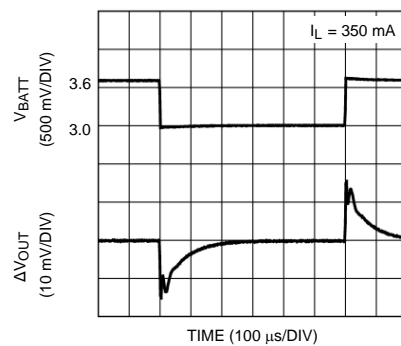

1.5-V Option

Figure 17. Line Transient Response  $V_{BATT}$

### 8.2.2 Additional Application Circuit

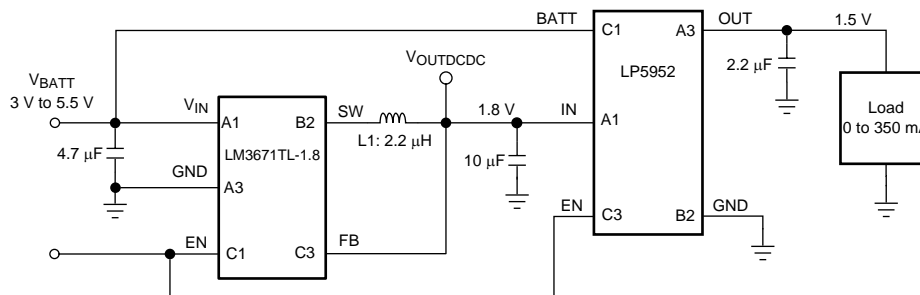

Figure 18. Typical Application Circuit With DC-DC Converter as Pre-Regulator for  $V_{IN}$

## 9 Power Supply Recommendations

This device is designed to operate from an input supply voltage range of 0.7 V to 4.5 V. The input supply should be well regulated and free of spurious noise. A minimum capacitor value of 1- $\mu$ F is required to be within 1 cm of the IN pin. The  $V_{BATT}$  range is 2.5 V to 5.5 V and, in the typical application,  $V_{BATT}$  is connected to batteries. In any application,  $V_{IN}$  does not exceed  $V_{BATT}$ .

## 10 Layout

### 10.1 Layout Guidelines

For best overall performance, place all circuit components on the same side of the circuit board and as near to the respective LDO pin connections as practical. Place ground return connections as close as possible to the input and output capacitor and to the LDO ground pin, connected by a wide, copper surface. The use of vias and long traces to create LDO circuit connection is strongly discouraged and negatively affect system performance.

### 10.2 Layout Examples

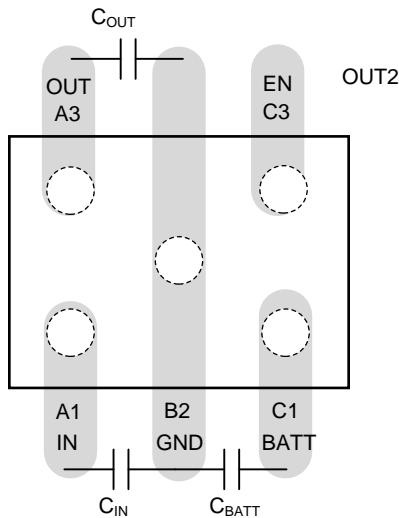

**Figure 19. LP5952 DSBGA Layout Example**

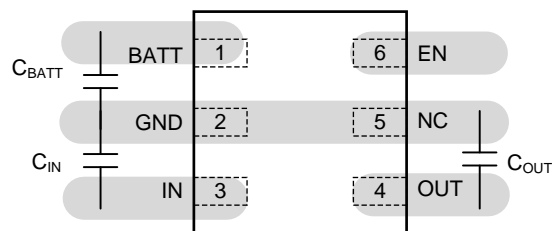

**Figure 20. LP5952 WSON Layout Example**

## 11 Device and Documentation Support

### 11.1 Device Support

For availability of evaluation boards, refer to the product folder of LP5952 at [www.ti.com](http://www.ti.com).

### 11.2 Documentation Support

#### 11.2.1 Related Documentation

For information regarding evaluation boards, please refer to AN-1531 *LP5952 Evaluation Board* ([SNVA188](#)).

### 11.3 Community Resources

The following links connect to TI community resources. Linked contents are provided "AS IS" by the respective contributors. They do not constitute TI specifications and do not necessarily reflect TI's views; see TI's [Terms of Use](#).

**TI E2E™ Online Community** *TI's Engineer-to-Engineer (E2E) Community*. Created to foster collaboration among engineers. At [e2e.ti.com](http://e2e.ti.com), you can ask questions, share knowledge, explore ideas and help solve problems with fellow engineers.

**Design Support** *TI's Design Support* Quickly find helpful E2E forums along with design support tools and contact information for technical support.

### 11.4 Trademarks

E2E is a trademark of Texas Instruments.

All other trademarks are the property of their respective owners.

### 11.5 Electrostatic Discharge Caution



These devices have limited built-in ESD protection. The leads should be shorted together or the device placed in conductive foam during storage or handling to prevent electrostatic damage to the MOS gates.

### 11.6 Glossary

[SLYZ022](#) — *TI Glossary*.

This glossary lists and explains terms, acronyms, and definitions.

## 12 Mechanical, Packaging, and Orderable Information

The following pages include mechanical, packaging, and orderable information. This information is the most current data available for the designated devices. This data is subject to change without notice and revision of this document. For browser-based versions of this data sheet, refer to the left-hand navigation.

**PACKAGING INFORMATION**

Orderable Device	Status (1)	Package Type	Package Drawing	Pins	Package Qty	Eco Plan (2)	Lead finish/ Ball material (6)	MSL Peak Temp (3)	Op Temp (°C)	Device Marking (4/5)	Samples
LP5952LC-1.2/NOPB	ACTIVE	USON	NKH	6	1000	RoHS & Green	NIPDAU	Level-1-260C-UNLIM	-40 to 125	L28	<a href="#">Samples</a>
LP5952LC-1.3/NOPB	ACTIVE	USON	NKH	6	1000	RoHS & Green	NIPDAU	Level-1-260C-UNLIM	-40 to 125	L43	<a href="#">Samples</a>
LP5952LC-1.5/NOPB	ACTIVE	USON	NKH	6	1000	RoHS & Green	NIPDAU	Level-1-260C-UNLIM	-40 to 125	L25	<a href="#">Samples</a>
LP5952LC-1.8/NOPB	ACTIVE	USON	NKH	6	1000	RoHS & Green	NIPDAU	Level-1-260C-UNLIM	-40 to 125	L29	<a href="#">Samples</a>
LP5952TL-1.0/NOPB	ACTIVE	DSBGA	YZR	5	250	RoHS & Green	SNAGCU	Level-1-260C-UNLIM	-40 to 125	L	<a href="#">Samples</a>
LP5952TL-1.2/NOPB	ACTIVE	DSBGA	YZR	5	250	RoHS & Green	SNAGCU	Level-1-260C-UNLIM	-40 to 125	7	<a href="#">Samples</a>
LP5952TL-1.3/NOPB	ACTIVE	DSBGA	YZR	5	250	RoHS & Green	SNAGCU	Level-1-260C-UNLIM	-40 to 125	U	<a href="#">Samples</a>
LP5952TL-1.5/NOPB	ACTIVE	DSBGA	YZR	5	250	RoHS & Green	SNAGCU	Level-1-260C-UNLIM	-40 to 125	T	<a href="#">Samples</a>
LP5952TL-1.6/NOPB	ACTIVE	DSBGA	YZR	5	250	RoHS & Green	SNAGCU	Level-1-260C-UNLIM	-40 to 125	B	<a href="#">Samples</a>
LP5952TL-1.8/NOPB	ACTIVE	DSBGA	YZR	5	250	RoHS & Green	SNAGCU	Level-1-260C-UNLIM	-40 to 125	8	<a href="#">Samples</a>
LP5952TLX-1.0/NOPB	ACTIVE	DSBGA	YZR	5	3000	RoHS & Green	SNAGCU	Level-1-260C-UNLIM	-40 to 125	L	<a href="#">Samples</a>
LP5952TLX-1.2/NOPB	ACTIVE	DSBGA	YZR	5	3000	RoHS & Green	SNAGCU	Level-1-260C-UNLIM	-40 to 125	7	<a href="#">Samples</a>
LP5952TLX-1.5/NOPB	ACTIVE	DSBGA	YZR	5	3000	RoHS & Green	SNAGCU	Level-1-260C-UNLIM	-40 to 125	T	<a href="#">Samples</a>
LP5952TLX-1.8/NOPB	ACTIVE	DSBGA	YZR	5	3000	RoHS & Green	SNAGCU	Level-1-260C-UNLIM	-40 to 125	8	<a href="#">Samples</a>

(1) The marketing status values are defined as follows:

**ACTIVE:** Product device recommended for new designs.

**LIFEBUY:** TI has announced that the device will be discontinued, and a lifetime-buy period is in effect.

**NRND:** Not recommended for new designs. Device is in production to support existing customers, but TI does not recommend using this part in a new design.

**PREVIEW:** Device has been announced but is not in production. Samples may or may not be available.

**OBSELETE:** TI has discontinued the production of the device.

(2) **RoHS:** TI defines "RoHS" to mean semiconductor products that are compliant with the current EU RoHS requirements for all 10 RoHS substances, including the requirement that RoHS substance do not exceed 0.1% by weight in homogeneous materials. Where designed to be soldered at high temperatures, "RoHS" products are suitable for use in specified lead-free processes. TI may reference these types of products as "Pb-Free".

**RoHS Exempt:** TI defines "RoHS Exempt" to mean products that contain lead but are compliant with EU RoHS pursuant to a specific EU RoHS exemption.

**Green:** TI defines "Green" to mean the content of Chlorine (Cl) and Bromine (Br) based flame retardants meet JS709B low halogen requirements of  $\leq 1000$ ppm threshold. Antimony trioxide based flame retardants must also meet the  $\leq 1000$ ppm threshold requirement.

(3) MSL, Peak Temp. - The Moisture Sensitivity Level rating according to the JEDEC industry standard classifications, and peak solder temperature.

(4) There may be additional marking, which relates to the logo, the lot trace code information, or the environmental category on the device.

(5) Multiple Device Markings will be inside parentheses. Only one Device Marking contained in parentheses and separated by a "~" will appear on a device. If a line is indented then it is a continuation of the previous line and the two combined represent the entire Device Marking for that device.

(6) Lead finish/Ball material - Orderable Devices may have multiple material finish options. Finish options are separated by a vertical ruled line. Lead finish/Ball material values may wrap to two lines if the finish value exceeds the maximum column width.

**Important Information and Disclaimer:** The information provided on this page represents TI's knowledge and belief as of the date that it is provided. TI bases its knowledge and belief on information provided by third parties, and makes no representation or warranty as to the accuracy of such information. Efforts are underway to better integrate information from third parties. TI has taken and continues to take reasonable steps to provide representative and accurate information but may not have conducted destructive testing or chemical analysis on incoming materials and chemicals. TI and TI suppliers consider certain information to be proprietary, and thus CAS numbers and other limited information may not be available for release.

In no event shall TI's liability arising out of such information exceed the total purchase price of the TI part(s) at issue in this document sold by TI to Customer on an annual basis.

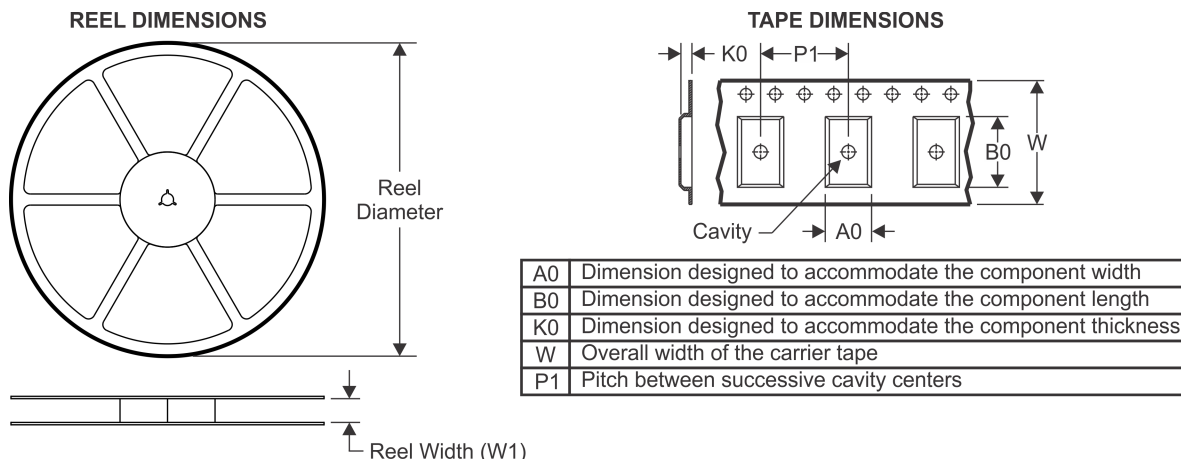
**TAPE AND REEL INFORMATION**

**QUADRANT ASSIGNMENTS FOR PIN 1 ORIENTATION IN TAPE**

\*All dimensions are nominal

Device	Package Type	Package Drawing	Pins	SPQ	Reel Diameter (mm)	Reel Width W1 (mm)	A0 (mm)	B0 (mm)	K0 (mm)	P1 (mm)	W (mm)	Pin1 Quadrant
LP5952LC-1.2/NOPB	USON	NKH	6	1000	178.0	12.4	2.2	2.2	1.0	8.0	12.0	Q1
LP5952LC-1.3/NOPB	USON	NKH	6	1000	178.0	12.4	2.2	2.2	1.0	8.0	12.0	Q1
LP5952LC-1.5/NOPB	USON	NKH	6	1000	178.0	12.4	2.2	2.2	1.0	8.0	12.0	Q1
LP5952LC-1.8/NOPB	USON	NKH	6	1000	178.0	12.4	2.2	2.2	1.0	8.0	12.0	Q1
LP5952TL-1.0/NOPB	DSBGA	YZR	5	250	178.0	8.4	1.04	1.4	0.76	4.0	8.0	Q1
LP5952TL-1.2/NOPB	DSBGA	YZR	5	250	178.0	8.4	1.04	1.4	0.76	4.0	8.0	Q1
LP5952TL-1.3/NOPB	DSBGA	YZR	5	250	178.0	8.4	1.04	1.4	0.76	4.0	8.0	Q1
LP5952TL-1.5/NOPB	DSBGA	YZR	5	250	178.0	8.4	1.04	1.4	0.76	4.0	8.0	Q1
LP5952TL-1.6/NOPB	DSBGA	YZR	5	250	178.0	8.4	1.04	1.4	0.76	4.0	8.0	Q1
LP5952TL-1.8/NOPB	DSBGA	YZR	5	250	178.0	8.4	1.04	1.4	0.76	4.0	8.0	Q1
LP5952TLX-1.0/NOPB	DSBGA	YZR	5	3000	178.0	8.4	1.04	1.4	0.76	4.0	8.0	Q1
LP5952TLX-1.2/NOPB	DSBGA	YZR	5	3000	178.0	8.4	1.04	1.4	0.76	4.0	8.0	Q1
LP5952TLX-1.5/NOPB	DSBGA	YZR	5	3000	178.0	8.4	1.04	1.4	0.76	4.0	8.0	Q1
LP5952TLX-1.8/NOPB	DSBGA	YZR	5	3000	178.0	8.4	1.04	1.4	0.76	4.0	8.0	Q1

**TAPE AND REEL BOX DIMENSIONS**

\*All dimensions are nominal

Device	Package Type	Package Drawing	Pins	SPQ	Length (mm)	Width (mm)	Height (mm)
LP5952LC-1.2/NOPB	USON	NKH	6	1000	208.0	191.0	35.0
LP5952LC-1.3/NOPB	USON	NKH	6	1000	208.0	191.0	35.0
LP5952LC-1.5/NOPB	USON	NKH	6	1000	208.0	191.0	35.0
LP5952LC-1.8/NOPB	USON	NKH	6	1000	208.0	191.0	35.0
LP5952TL-1.0/NOPB	DSBGA	YZR	5	250	208.0	191.0	35.0
LP5952TL-1.2/NOPB	DSBGA	YZR	5	250	208.0	191.0	35.0
LP5952TL-1.3/NOPB	DSBGA	YZR	5	250	208.0	191.0	35.0
LP5952TL-1.5/NOPB	DSBGA	YZR	5	250	208.0	191.0	35.0
LP5952TL-1.6/NOPB	DSBGA	YZR	5	250	208.0	191.0	35.0
LP5952TL-1.8/NOPB	DSBGA	YZR	5	250	208.0	191.0	35.0
LP5952TLX-1.0/NOPB	DSBGA	YZR	5	3000	208.0	191.0	35.0
LP5952TLX-1.2/NOPB	DSBGA	YZR	5	3000	208.0	191.0	35.0
LP5952TLX-1.5/NOPB	DSBGA	YZR	5	3000	208.0	191.0	35.0
LP5952TLX-1.8/NOPB	DSBGA	YZR	5	3000	208.0	191.0	35.0

NKH0006B

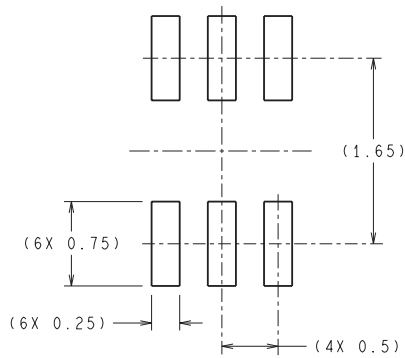

RECOMMENDED LAND PATTERN

DIMENSIONS ARE IN MILLIMETERS  
DIMENSION IN ( ) FOR REFERENCE ONLY

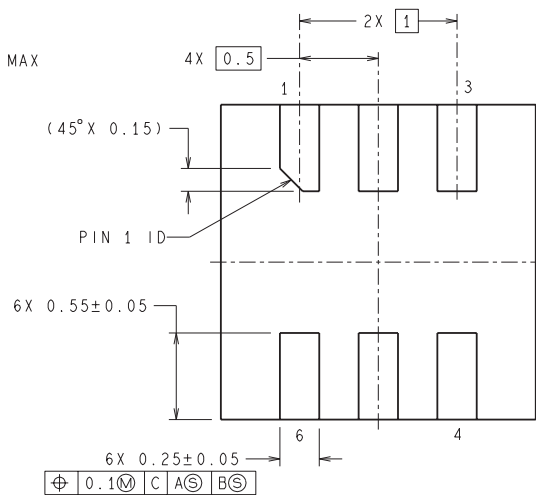
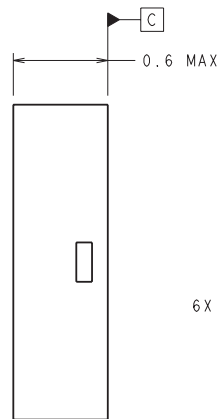
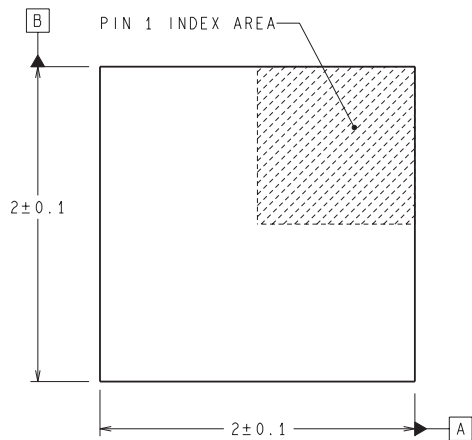
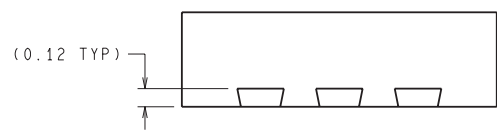

6X 0.25 ± 0.05  
⊕ 0.1 (M) C A ⊙ B ⊙

LCA06B (Rev A)



## IMPORTANT NOTICE AND DISCLAIMER

TI PROVIDES TECHNICAL AND RELIABILITY DATA (INCLUDING DATA SHEETS), DESIGN RESOURCES (INCLUDING REFERENCE DESIGNS), APPLICATION OR OTHER DESIGN ADVICE, WEB TOOLS, SAFETY INFORMATION, AND OTHER RESOURCES "AS IS" AND WITH ALL FAULTS, AND DISCLAIMS ALL WARRANTIES, EXPRESS AND IMPLIED, INCLUDING WITHOUT LIMITATION ANY IMPLIED WARRANTIES OF MERCHANTABILITY, FITNESS FOR A PARTICULAR PURPOSE OR NON-INFRINGEMENT OF THIRD PARTY INTELLECTUAL PROPERTY RIGHTS.

These resources are intended for skilled developers designing with TI products. You are solely responsible for (1) selecting the appropriate TI products for your application, (2) designing, validating and testing your application, and (3) ensuring your application meets applicable standards, and any other safety, security, regulatory or other requirements.

These resources are subject to change without notice. TI grants you permission to use these resources only for development of an application that uses the TI products described in the resource. Other reproduction and display of these resources is prohibited. No license is granted to any other TI intellectual property right or to any third party intellectual property right. TI disclaims responsibility for, and you will fully indemnify TI and its representatives against, any claims, damages, costs, losses, and liabilities arising out of your use of these resources.

TI's products are provided subject to [TI's Terms of Sale](#) or other applicable terms available either on [ti.com](http://ti.com) or provided in conjunction with such TI products. TI's provision of these resources does not expand or otherwise alter TI's applicable warranties or warranty disclaimers for TI products.

TI objects to and rejects any additional or different terms you may have proposed.

Mailing Address: Texas Instruments, Post Office Box 655303, Dallas, Texas 75265  
Copyright © 2021, Texas Instruments Incorporated