

# LMZ22005 5A SIMPLE SWITCHER® Power Module with 20V Maximum Input Voltage

 Check for Samples: [LMZ22005](#)

## FEATURES

- Integrated Shielded Inductor
- Simple PCB Layout
- Frequency Synchronization Input (650 kHz to 950 kHz)
- Flexible Startup Sequencing Using External Soft-start, Tracking and Precision Enable
- Protection Against Inrush Currents and Faults such as Input UVLO and Output Short Circuit
- – 40°C to 125°C Junction Temperature Range
- Single Exposed Pad for Easy Mounting and Manufacturing
- Fast Transient Response for Powering FPGAs and ASICs
- Fully Enabled for Webench® Power Designer
- Pin Compatible with LMZ23605/LMZ23603/LMZ22003

## APPLICATIONS

- Point of Load Conversions from 12V Input Rail
- Time Critical Projects
- Space Constrained / High Thermal Requirement Applications
- Negative Output Voltage Applications (see AN-2027 [SNVA425](#))

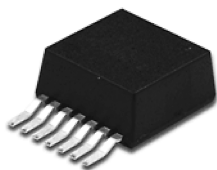

Top View

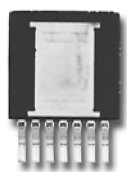

Bottom View

**Figure 1. Easy to use 7 pin package**  
**PFM 7 Pin Package**

**10.16 x 13.77 x 4.57 mm (0.4 x 0.542 x 0.18 in)**  
 **$\theta_{JA} = 12^{\circ}\text{C/W}$ ,  $\theta_{JC} = 1.9^{\circ}\text{C/W}$**   
**RoHS Compliant**

## DESCRIPTION

The LMZ22005 SIMPLE SWITCHER® power module is an easy-to-use step-down DC-DC solution capable of driving up to 5A load. The LMZ22005 is available in an innovative package that enhances thermal performance and allows for hand or machine soldering.

The LMZ22005 can accept an input voltage rail between 6V and 20V and deliver an adjustable and highly accurate output voltage as low as 0.8V. The LMZ22005 only requires two external resistors and three external capacitors to complete the power solution. The LMZ22005 is a reliable and robust design with the following protection features: thermal shutdown, input under-voltage lockout, output over-voltage protection, short-circuit protection, output current limit, and allows startup into a pre-biased output. The sync input allows synchronization over the 650 to 950 kHz switching frequency range.

## ELECTRICAL SPECIFICATIONS

- 30W Maximum Total Output Power
- Up to 5A Output Current
- Input Voltage Range 6V to 20V
- Output Voltage Range 0.8V to 6V
- Efficiency up to 92%

## PERFORMANCE BENEFITS

- High Efficiency Reduces System Heat Generation
- Complies with EN55022 Class B <sup>(1)</sup>
- Low Component Count, Only 5 External Components
- Low Output Voltage Ripple
- Uses PCB as Heat Sink, no Airflow Required

(1) EN 55022:2006, +A1:2007, FCC Part 15 Subpart B: 2007. See AN-2125 [SNVA473](#) and layout for information on device under test.  $V_{in} = 12\text{V}$ ,  $V_o = 3.3\text{V}$ ,  $I_o = 5\text{A}$



Please be aware that an important notice concerning availability, standard warranty, and use in critical applications of Texas Instruments semiconductor products and disclaimers thereto appears at the end of this data sheet.

All trademarks are the property of their respective owners.

### System Performance

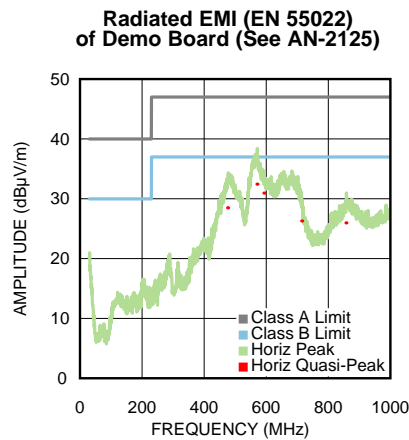
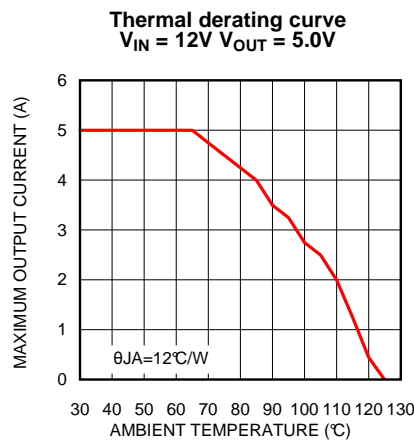
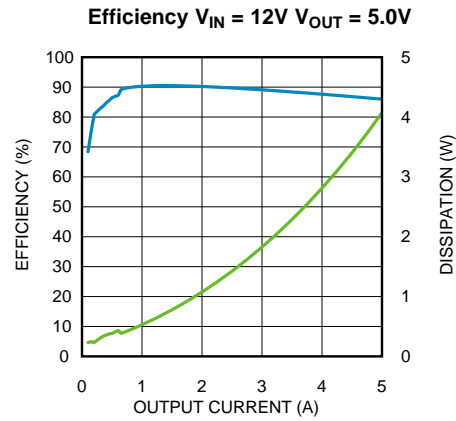

### Simplified Application Schematic

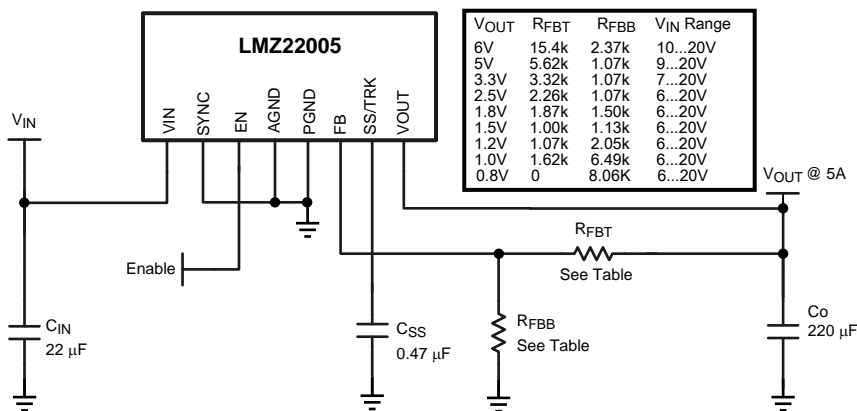

### Connection Diagram

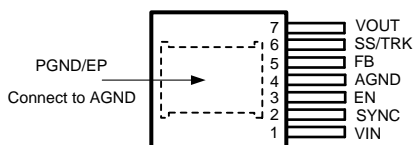

Figure 2. Top View  
7-Lead PFM

### Pin Descriptions

Pin	Name	Description
1	VIN	Supply input — Nominal operating range is 6V to 20V . A small amount of internal capacitance is contained within the package assembly. Additional external input capacitance is required between this pin and exposed pad (PGND).
2	SYNC	Sync Input — Apply a CMOS logic level square wave whose frequency is between 650 kHz and 950 kHz to synchronize the PWM operating frequency to an external frequency source. When not using synchronization connect to ground. The module free running PWM frequency is 812 kHz (Typ)
3	EN	Enable — Input to the precision enable comparator. Rising threshold is 1.279V typical. Once the module is enabled, a 20 uA source current is internally activated to accommodate programmable hysteresis.
4	AGND	Analog Ground — Reference point for all stated voltages. Must be externally connected to EP/PGND.
5	FB	Feedback — Internally connected to the regulation, over-voltage, and short-circuit comparators. The regulation reference point is 0.796V at this input pin. Connect the feedback resistor divider between the output and AGND to set the output voltage.
6	SS/TRK	Soft-Start/Track — To extend the 1.6 mSec internal soft-start connect an external soft start capacitor. For tracking connect to an external resistive divider connected to a higher priority supply rail. See applications section.
7	VOUT	Output Voltage — Output from the internal inductor. Connect the output capacitor between this pin and exposed pad.
EP	PGND	Exposed Pad / Power Ground Electrical path for the power circuits within the module. — NOT Internally connected to AGND / pin 4. Used to dissipate heat from the package during operation. Must be electrically connected to pin 4 external to the package.



These devices have limited built-in ESD protection. The leads should be shorted together or the device placed in conductive foam during storage or handling to prevent electrostatic damage to the MOS gates.

### Absolute Maximum Ratings <sup>(1)(2)</sup>

VIN to PGND	-0.3V to 24V
EN, SYNC to AGND	-0.3V to 5.5V
SS/TRK, FB to AGND	-0.3V to 2.5V
AGND to PGND	-0.3V to 0.3V
Junction Temperature	150°C
Storage Temperature Range	-65°C to 150°C
ESD Susceptibility <sup>(3)</sup>	± 2 kV
Peak Reflow Case Temperature (30 sec)	245°C
For soldering specifications, refer to the following document: <a href="http://www.ti.com/lit/snoa549c">www.ti.com/lit/snoa549c</a>	

- (1) Absolute Maximum Ratings are limits beyond which damage to the device may occur. Operating Ratings are conditions under which operation of the device is intended to be functional. For guaranteed specifications and test conditions, see the Electrical Characteristics.
- (2) If Military/Aerospace specified devices are required, please contact the Texas Instruments Sales Office/ Distributors for availability and specifications.
- (3) The human body model is a 100pF capacitor discharged through a 1.5 kΩ resistor into each pin. Test method is per JESD-22-114.

### Operating Ratings <sup>(1)</sup>

VIN	6V to 20V
EN, SYNC	0V to 5.0V
Operation Junction Temperature	-40°C to 125°C

- (1) Absolute Maximum Ratings are limits beyond which damage to the device may occur. Operating Ratings are conditions under which operation of the device is intended to be functional. For guaranteed specifications and test conditions, see the Electrical Characteristics.

### Electrical Characteristics

Limits in standard type are for  $T_J = 25^\circ\text{C}$  only; limits in boldface type apply over the junction temperature ( $T_J$ ) range of  $-40^\circ\text{C}$  to  $+125^\circ\text{C}$ . Minimum and Maximum limits are guaranteed through test, design or statistical correlation. Typical values represent the most likely parametric norm at  $T_J = 25^\circ\text{C}$ , and are provided for reference purposes only. Unless otherwise stated the following conditions apply:  $V_{IN} = 12\text{V}$ ,  $V_{out} = 3.3\text{V}$

Symbol	Parameter	Conditions	Min (1)	Typ (2)	Max (1)	Units
<b>SYSTEM PARAMETERS</b>						
<b>Enable Control</b>						
$V_{EN}$	EN threshold trip point	$V_{EN}$ rising	<b>1.10</b>	1.279	<b>1.458</b>	V
$V_{EN-HYS}$	EN hysteresis	$V_{EN} > 1.279\text{V}$		21		μA
<b>Soft-Start</b>						
$I_{SS}$	SS source current	$V_{SS} = 0\text{V}$	<b>40</b>	50	<b>60</b>	μA
$t_{SS}$	Internal soft-start interval			1.6		msec
<b>Current Limit</b>						
$I_{CL}$	Current limit threshold	d.c. average	<b>5.4</b>			A
<b>Internal Switching Oscillator</b>						
$f_{osc}$	Free-running oscillator frequency	Sync input connected to ground.	711	812	914	kHz
$f_{sync}$	Synchronization range		650		950	kHz
$V_{IL-sync}$	Synchronization logic zero amplitude	Relative to AGND			<b>0.4</b>	V
$V_{IH-sync}$	Synchronization logic one amplitude	Relative to AGND	<b>1.5</b>			V
Sync <sub>d.c.</sub>	Synchronization duty cycle range		15	50	85	%
$D_{max}$	Maximum Duty Factor			83		%

- (1) Min and Max limits are 100% production tested at  $25^\circ\text{C}$ . Limits over the operating temperature range are guaranteed through correlation using Statistical Quality Control (SQC) methods. Limits are used to calculate Average Outgoing Quality Level (AOQL).
- (2) Typical numbers are at  $25^\circ\text{C}$  and represent the most likely parametric norm.

## Electrical Characteristics (continued)

Limits in standard type are for  $T_J = 25^\circ\text{C}$  only; limits in boldface type apply over the junction temperature ( $T_J$ ) range of  $-40^\circ\text{C}$  to  $+125^\circ\text{C}$ . Minimum and Maximum limits are guaranteed through test, design or statistical correlation. Typical values represent the most likely parametric norm at  $T_J = 25^\circ\text{C}$ , and are provided for reference purposes only. Unless otherwise stated the following conditions apply:  $V_{IN} = 12\text{V}$ ,  $V_{out} = 3.3\text{V}$

Symbol	Parameter	Conditions	Min (1)	Typ (2)	Max (1)	Units
<b>Regulation and Over-Voltage Comparator</b>						
$V_{FB}$	In-regulation feedback voltage	$V_{SS} >+ 0.8\text{V}$ $I_O = 5\text{A}$	<b>0.776</b>	0.796	<b>0.816</b>	V
$V_{FB-OV}$	Feedback over-voltage protection threshold			0.86		V
$I_{FB}$	Feedback input bias current			5		nA
$I_Q$	Non Switching Input Current	$V_{FB} = 0.86\text{V}$		2.6		mA
$I_{SD}$	Shut Down Quiescent Current	$V_{EN} = 0\text{V}$		70		$\mu\text{A}$
<b>Thermal Characteristics</b>						
$T_{SD}$	Thermal Shutdown	Rising		165		$^\circ\text{C}$
$T_{SD-HYST}$	Thermal shutdown hysteresis	Falling		15		$^\circ\text{C}$
$\theta_{JA}$	Junction to Ambient <sup>(3)</sup>	4 layer Evaluation Printed Circuit Board, 60 vias, No air flow		19.3		$^\circ\text{C/W}$
		2 layer JEDEC Printed Circuit Board, No air flow		21.5		$^\circ\text{C/W}$
$\theta_{JC}$	Junction to Case	No air flow		1.9		$^\circ\text{C/W}$
<b>PERFORMANCE PARAMETERS<sup>(4)</sup></b>						
$\Delta V_O$	Output voltage ripple	$C_{out} = 220\mu\text{F}$ w/ 7 milliohm ESR + $100\mu\text{F}$ X5R + $2 \times 0.047\mu\text{F}$ BW@ 20 MHz		9		mV <sub>PP</sub>
$\Delta V_O/\Delta V_{IN}$	Line regulation	$V_{IN} = 12\text{V}$ to $20\text{V}$ , $I_O = 0.001\text{A}$		$\pm 0.02$		%
$\Delta V_O/\Delta I_{OUT}$	Load regulation	$V_{IN} = 12\text{V}$ , $I_O = 0.001\text{A}$ to $5\text{A}$		1		mV/A
$\eta$	Peak efficiency	$V_{IN} = 12\text{V}$ $V_O = 3.3\text{V}$ $I_O = 1\text{A}$		86		%
$\eta$	Full load efficiency	$V_{IN} = 12\text{V}$ $V_O = 3.3\text{V}$ $I_O = 5\text{A}$		81.5		%

(3) Theta JA measured on a 3.5" x 3.5" four layer board, with three ounce copper on outer layers and two ounce copper on inner layers, sixty 10 mil thermal vias, no air flow, and 1W power dissipation. Refer to application note layout diagrams.

(4) Refer to BOM in [Typical Application Bill of Materials](#).

### Typical Performance Characteristics

Unless otherwise specified, the following conditions apply:  $V_{IN} = 12V$ ;  $C_{in} = 2 \times 10\mu F + 1\mu F$  X7R Ceramic;  $C_{O} = 220\mu F$  Specialty Polymer + 10  $\mu F$  Ceramic;  $T_{ambient} = 25^\circ C$  for waveforms. Efficiency and dissipation plots marked with \* have cycle skipping at light loads resulting in slightly higher output ripple – See [Design Steps for the LMZ22005 Application](#) section.

Efficiency 6.0V Output @ 25°C Ambient

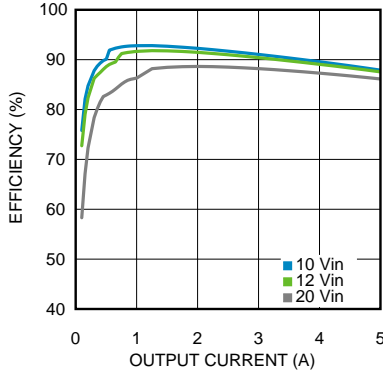

Figure 3.

Dissipation 6.0V Output @ 25°C Ambient

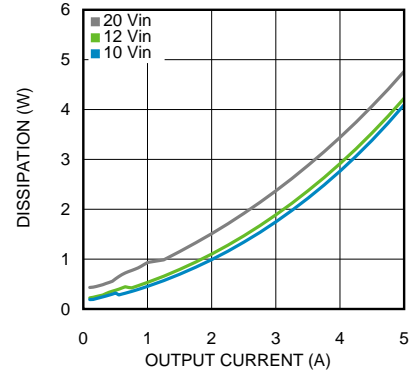

Figure 4.

Efficiency 5.0V Output @ 25°C Ambient

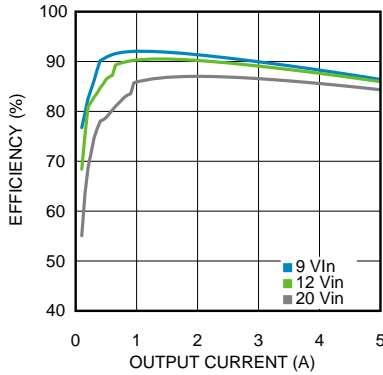

Figure 5.

Dissipation 5.0V Output @ 25°C Ambient

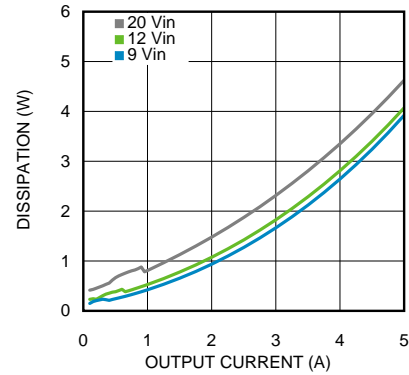

Figure 6.

Efficiency 3.3V Output @ 25°C Ambient

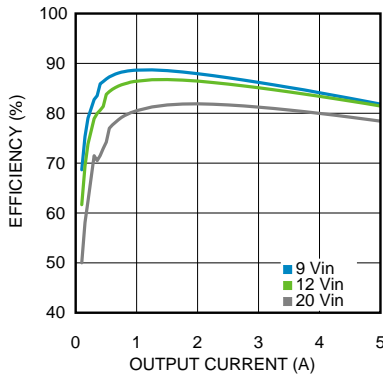

Figure 7.

Dissipation 3.3V Output @ 25°C Ambient

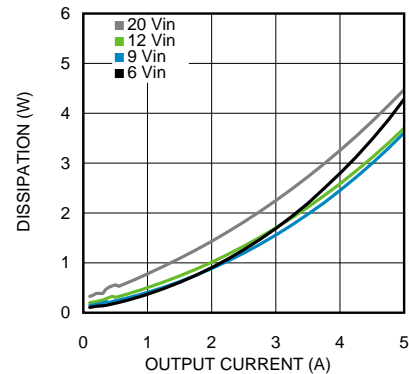

Figure 8.

### Typical Performance Characteristics (continued)

Unless otherwise specified, the following conditions apply:  $V_{IN} = 12V$ ;  $C_{in} = 2 \times 10\mu F + 1\mu F$  X7R Ceramic;  $C_{O} = 220\mu F$  Specialty Polymer + 10  $\mu F$  Ceramic;  $T_{ambient} = 25^\circ C$  for waveforms. Efficiency and dissipation plots marked with \* have cycle skipping at light loads resulting in slightly higher output ripple – See [Design Steps for the LMZ22005 Application](#) section.

Efficiency 2.5V Output @ 25°C Ambient

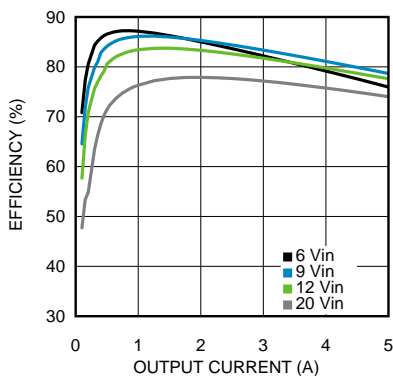

Figure 9.

Dissipation 2.5V Output @ 25°C Ambient

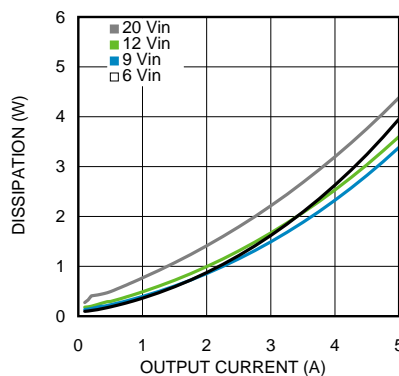

Figure 10.

Efficiency 1.8V Output @ 25°C Ambient

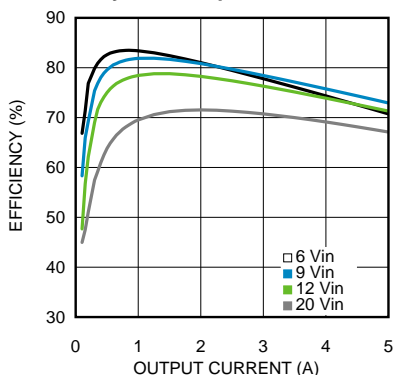

Figure 11.

Dissipation 1.8V Output @ 25°C Ambient

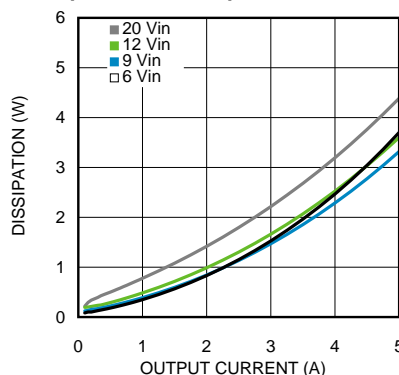

Figure 12.

Efficiency 1.5V Output @ 25°C Ambient

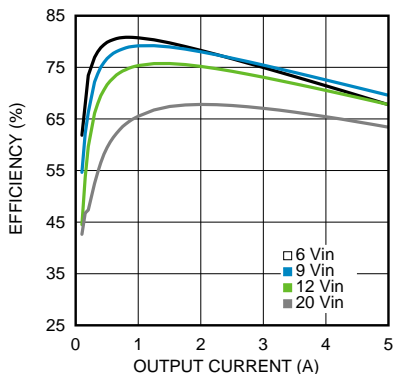

Figure 13.

Dissipation 1.5V Output @ 25°C Ambient

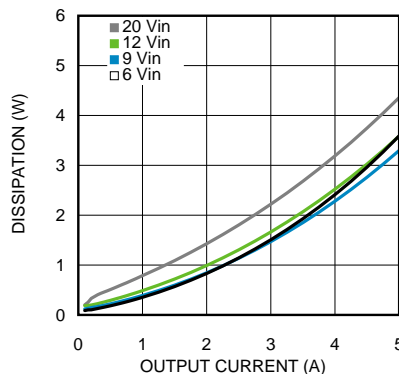
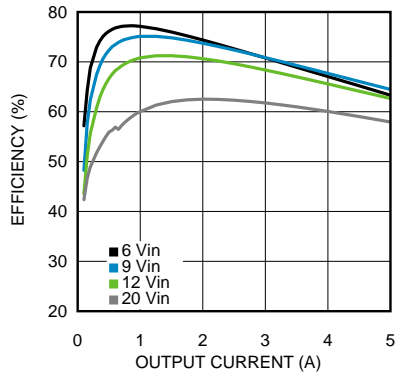

Figure 14.

### Typical Performance Characteristics (continued)

Unless otherwise specified, the following conditions apply:  $V_{IN} = 12V$ ;  $C_{in} = 2 \times 10\mu F + 1\mu F$  X7R Ceramic;  $C_{O} = 220\mu F$  Specialty Polymer + 10  $\mu F$  Ceramic;  $T_{ambient} = 25^\circ C$  for waveforms. Efficiency and dissipation plots marked with \* have cycle skipping at light loads resulting in slightly higher output ripple – See [Design Steps for the LMZ22005 Application](#) section.

**Efficiency 1.2V Output @ 25°C Ambient**



**Figure 15.**

**Dissipation 1.2V Output @ 25°C Ambient**

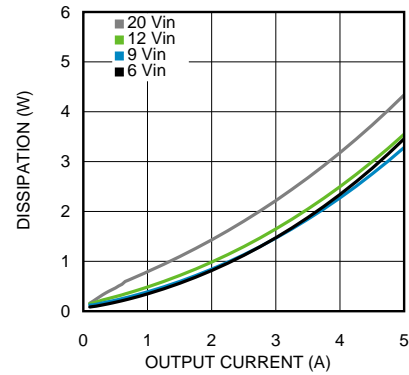

**Figure 16.**

**Efficiency 1.0V Output @ 25°C Ambient**

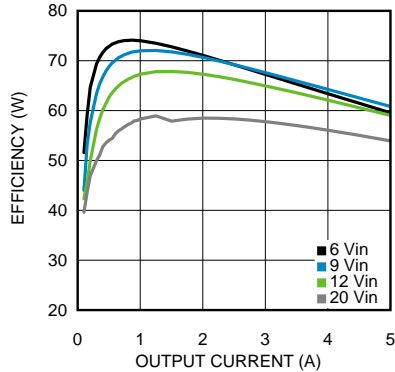

**Figure 17.**

**Dissipation 1.0V Output @ 25°C Ambient**

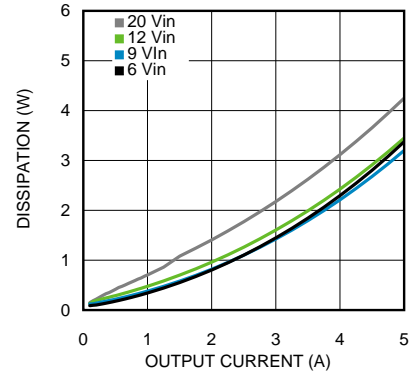

**Figure 18.**

**Efficiency 0.8V Output @ 25°C Ambient**

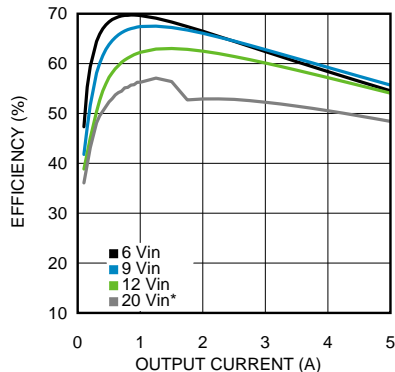

**Figure 19.**

**Dissipation 0.8V Output @ 25°C Ambient**

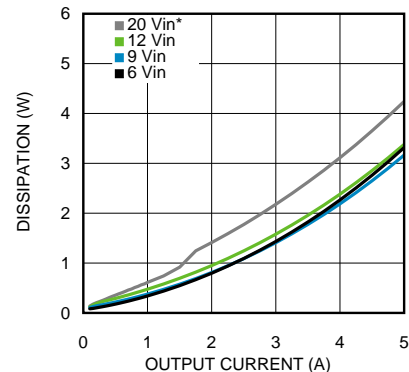

**Figure 20.**

### Typical Performance Characteristics (continued)

Unless otherwise specified, the following conditions apply:  $V_{IN} = 12V$ ;  $C_{in} = 2 \times 10\mu F + 1\mu F$  X7R Ceramic;  $C_{O} = 220\mu F$  Specialty Polymer +  $10 \mu F$  Ceramic;  $T_{ambient} = 25^\circ C$  for waveforms. Efficiency and dissipation plots marked with \* have cycle skipping at light loads resulting in slightly higher output ripple – See [Design Steps for the LMZ22005 Application](#) section.

Efficiency 6.0V Output @ 85°C Ambient

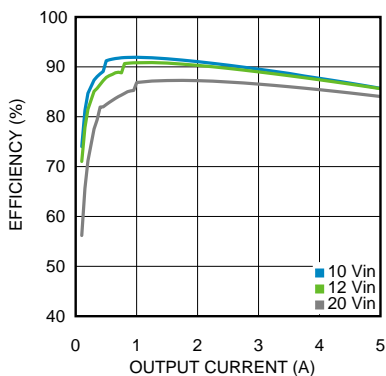

Figure 21.

Dissipation 6.0V Output @ 85°C Ambient

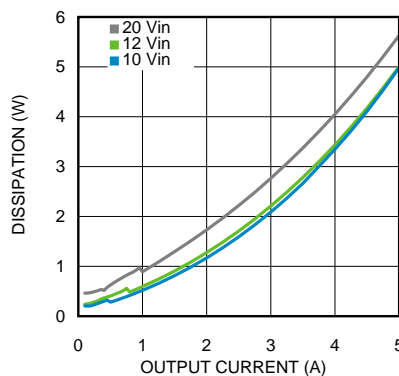

Figure 22.

Efficiency 5.0V Output @ 85°C Ambient

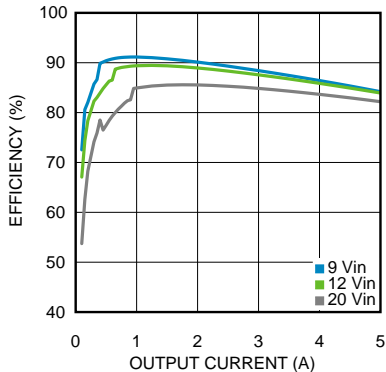

Figure 23.

Dissipation 5.0V Output @ 85°C Ambient

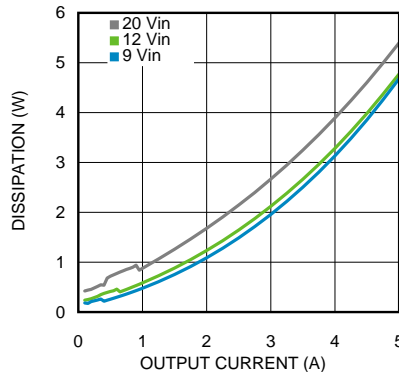

Figure 24.

Efficiency 3.3V Output @ 85°C Ambient

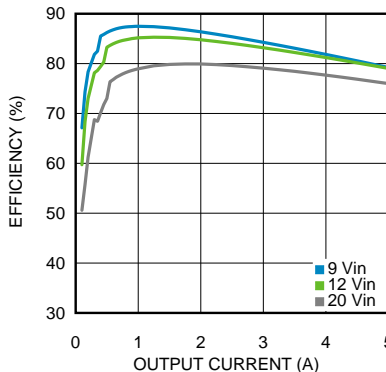

Figure 25.

Dissipation 3.3V Output @ 85°C Ambient

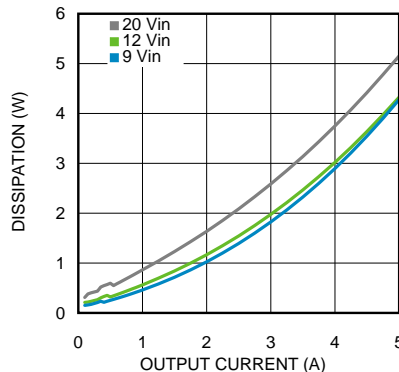
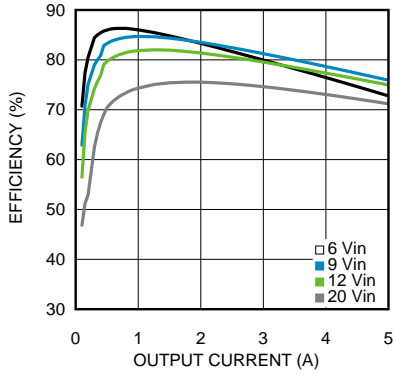

Figure 26.

### Typical Performance Characteristics (continued)

Unless otherwise specified, the following conditions apply:  $V_{IN} = 12V$ ;  $C_{in} = 2 \times 10\mu F + 1\mu F$  X7R Ceramic;  $C_O = 220\mu F$  Specialty Polymer +  $10 \mu F$  Ceramic;  $T_{ambient} = 25^\circ C$  for waveforms. Efficiency and dissipation plots marked with \* have cycle skipping at light loads resulting in slightly higher output ripple – See [Design Steps for the LMZ22005 Application](#) section.

**Efficiency 2.5V Output @ 85°C Ambient**



**Figure 27.**

**Dissipation 2.5V Output @ 85°C Ambient**

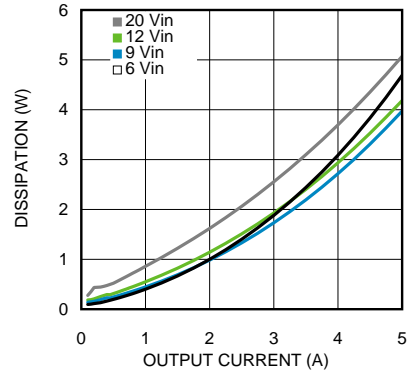

**Figure 28.**

**Efficiency 1.8V Output @ 85°C Ambient**

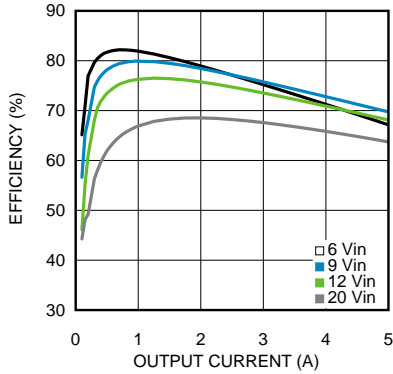

**Figure 29.**

**Dissipation 1.8V Output @ 85°C Ambient**

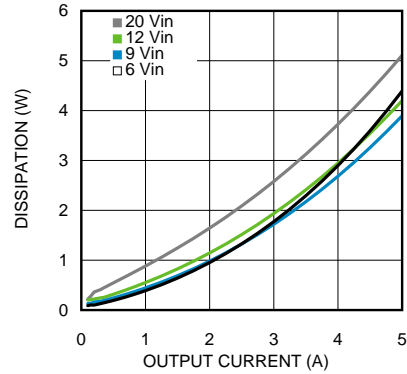

**Figure 30.**

**Efficiency 1.5V Output @ 85°C Ambient**

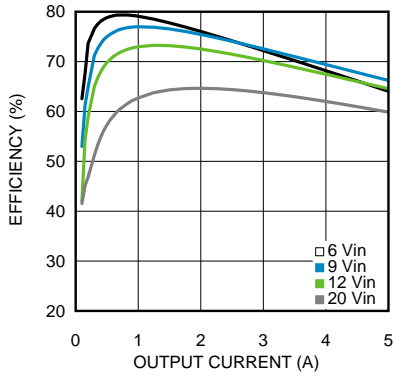

**Figure 31.**

**Dissipation 1.5V Output @ 85°C Ambient**

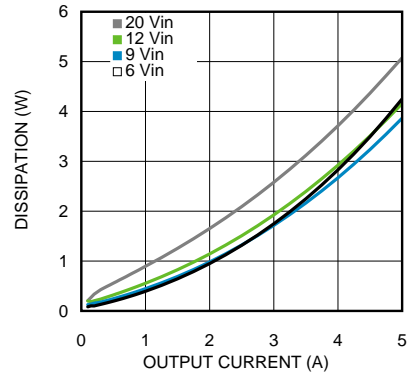

**Figure 32.**

### Typical Performance Characteristics (continued)

Unless otherwise specified, the following conditions apply:  $V_{IN} = 12V$ ;  $C_{in} = 2 \times 10\mu F + 1\mu F$  X7R Ceramic;  $C_{O} = 220\mu F$  Specialty Polymer +  $10 \mu F$  Ceramic;  $T_{ambient} = 25^\circ C$  for waveforms. Efficiency and dissipation plots marked with \* have cycle skipping at light loads resulting in slightly higher output ripple – See [Design Steps for the LMZ22005 Application](#) section.

Efficiency 1.2V Output @ 85°C Ambient

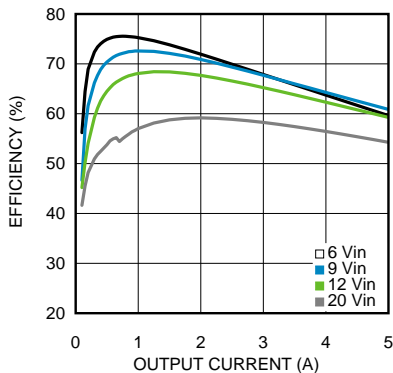

Figure 33.

Dissipation 1.2V Output @ 85°C Ambient

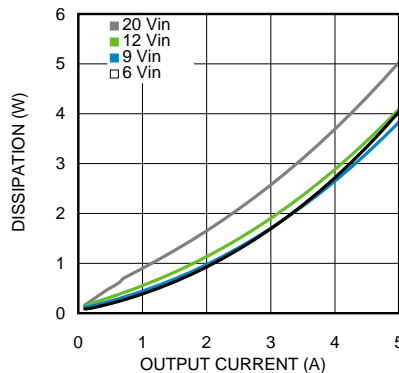

Figure 34.

Efficiency 1.0V Output @ 85°C Ambient

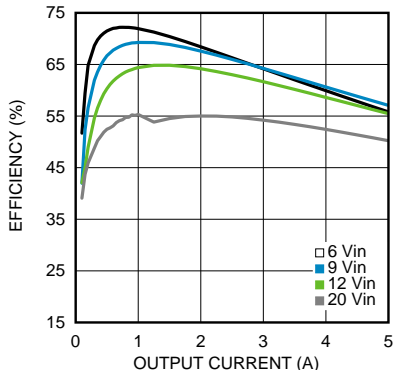

Figure 35.

Dissipation 1.0V Output @ 85°C Ambient

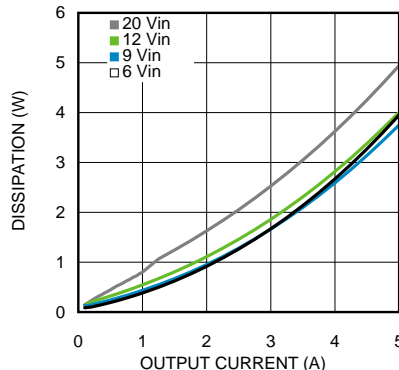

Figure 36.

Efficiency 0.8V @ 85°C Ambient

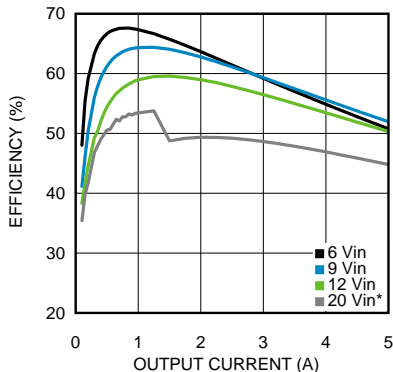

Figure 37.

Dissipation 0.8V Output @ 85°C Ambient

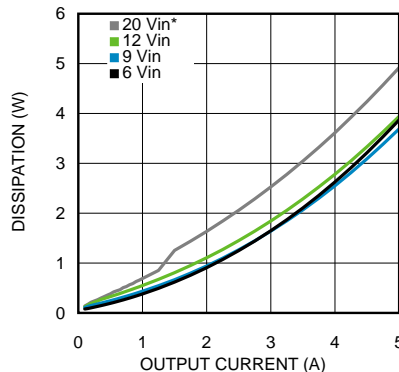

Figure 38.

### Typical Performance Characteristics (continued)

Unless otherwise specified, the following conditions apply:  $V_{IN} = 12V$ ;  $C_{in} = 2 \times 10\mu F + 1\mu F$  X7R Ceramic;  $C_{O} = 220\mu F$  Specialty Polymer +  $10 \mu F$  Ceramic;  $T_{ambient} = 25^\circ C$  for waveforms. Efficiency and dissipation plots marked with \* have cycle skipping at light loads resulting in slightly higher output ripple – See [Design Steps for the LMZ22005 Application](#) section.

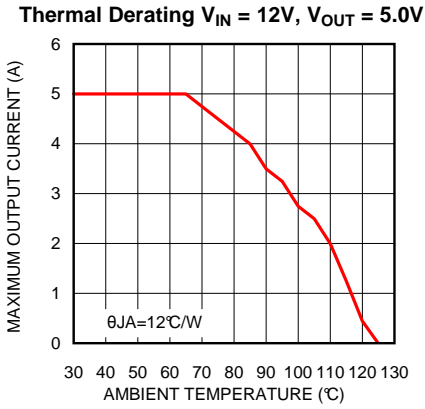

Figure 39.

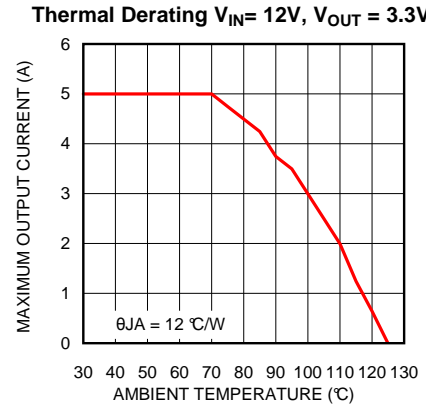

Figure 40.

**Normalized — Line and Load Regulation  $V_{OUT} = 3.3V$**

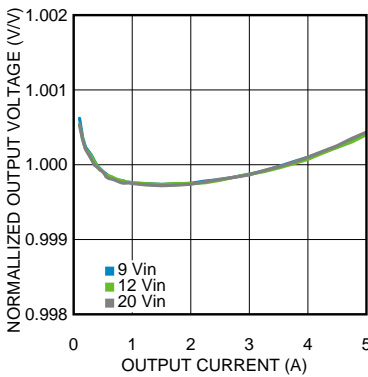

Figure 41.

**Output Ripple  $12V_{IN} 3.3V_{O} @ 5A, BW = 20 MHz$**

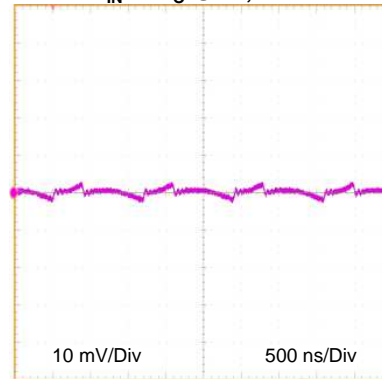

Figure 42.

**Output Ripple  $12V_{IN} 3.3V_{O} @ 5A BW = 250 MHz$**

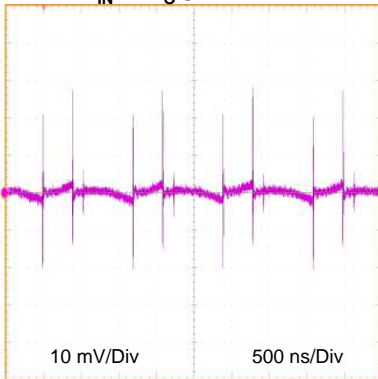

Figure 43.

**Transient Response From Evaluation Board  $12V_{IN} 3.3V_{O} 0.5 to 5A Step$**

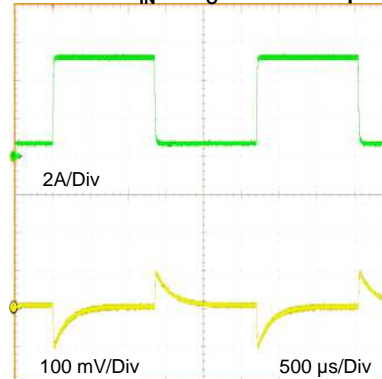
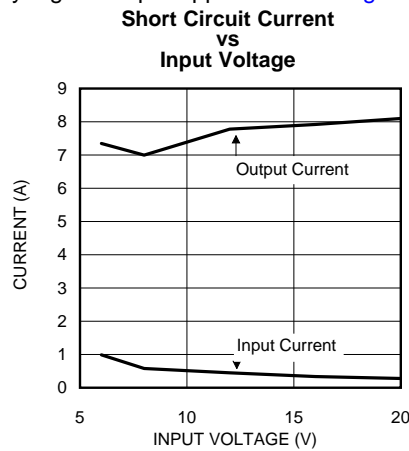

Figure 44.

**Typical Performance Characteristics (continued)**

Unless otherwise specified, the following conditions apply:  $V_{IN} = 12V$ ;  $C_{in} = 2 \times 10\mu F + 1\mu F$  X7R Ceramic;  $C_O = 220\mu F$  Specialty Polymer + 10 uF Ceramic;  $T_{ambient} = 25^\circ C$  for waveforms. Efficiency and dissipation plots marked with \* have cycle skipping at light loads resulting in slightly higher output ripple – See [Design Steps for the LMZ22005 Application](#) section.



**Figure 45.**

BLOCK DIAGRAM

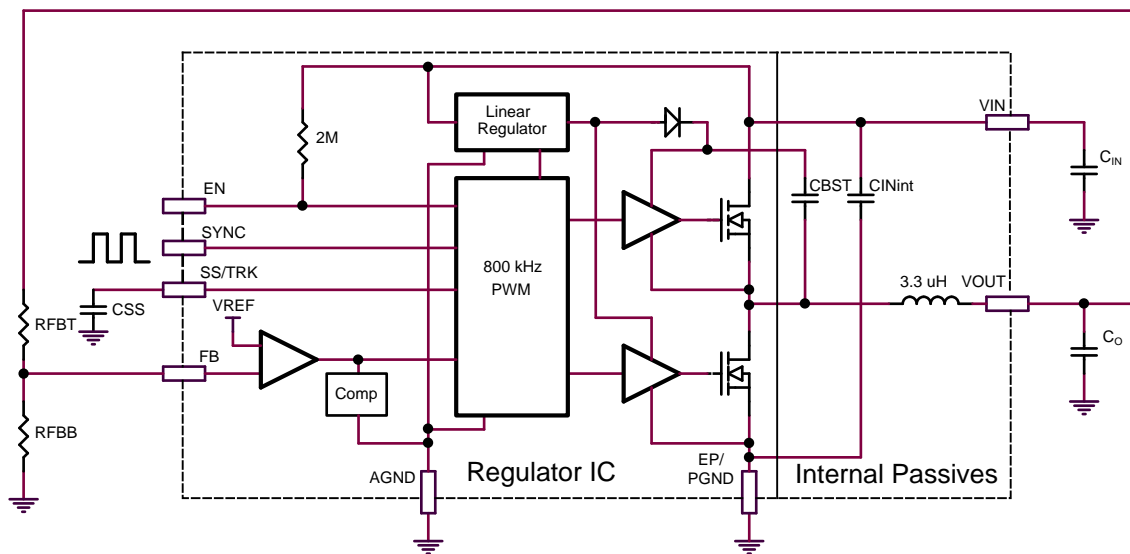

## DESIGN STEPS FOR THE LMZ22005 APPLICATION

The LMZ22005 is fully supported by Webench® which offers: component selection, electrical and thermal simulations. Additionally there are evaluation and demonstration boards that may be used as a starting point for design. The following list of steps can be used to quickly design the LMZ22005 application.

- Select minimum operating  $V_{IN}$  with enable divider resistors
- Program  $V_O$  with resistor divider selection
- Select  $C_O$
- Select  $C_{IN}$
- Determine module power dissipation
- Layout PCB for required thermal performance

### ENABLE DIVIDER, $R_{ENT}$ , $R_{ENB}$ AND $R_{ENH}$ SELECTION

Internal to the module is a 2 mega ohm pull-up resistor connected from  $V_{IN}$  to Enable. For applications not requiring precision under voltage lock out (UVLO), the Enable input may be left open circuit and the internal resistor will always enable the module. In such case, the internal UVLO occurs typically at 4.3V ( $V_{IN}$  rising).

In applications with separate supervisory circuits Enable can be directly interfaced to a logic source. In the case of sequencing supplies, the divider is connected to a rail that becomes active earlier in the power-up cycle than the LMZ22005 output rail.

Enable provides a precise 1.279V threshold to allow direct logic drive or connection to a voltage divider from a higher enable voltage such as  $V_{IN}$ . Additionally there is 21  $\mu$ A(typ) of switched offset current allowing programmable hysteresis. See [Figure 46](#).

The function of the enable divider is to allow the designer to choose an input voltage below which the circuit will be disabled. This implements the feature of programmable UVLO. The two resistors should be chosen based on the following ratio:

$$R_{ENT} / R_{ENB} = (V_{IN\ UVLO} / 1.279V) - 1 \quad (1)$$

The LMZ22005 typical application shows 12.7k $\Omega$  for  $R_{ENB}$  and 42.2k $\Omega$  for  $R_{ENT}$  resulting in a rising UVLO of 5.46V. Note that a midpoint 5.1V Zener clamp is present to allow setting UVLO to cover an extended range of operation. The zener clamp is not required if the target application prohibits the maximum Enable input voltage from being exceeded.

Additional enable voltage hysteresis can be added with the inclusion of  $R_{ENH}$ . It may be possible to select values for  $R_{ENT}$  and  $R_{ENB}$  such that  $R_{ENH}$  is a value of zero allowing it to be omitted from the design.

Rising threshold can be calculated as follows:

$$V_{EN}(\text{rising}) = 1.279 ( 1 + R_{ENT} / 2\text{ meg} / R_{ENB} )$$

Whereas falling threshold level can be calculated using:

$$V_{EN}(\text{falling}) = V_{EN}(\text{rising}) - 21\ \mu\text{A} ( R_{ENT} / 2\text{ meg} \parallel R_{ENB} + R_{ENH} )$$

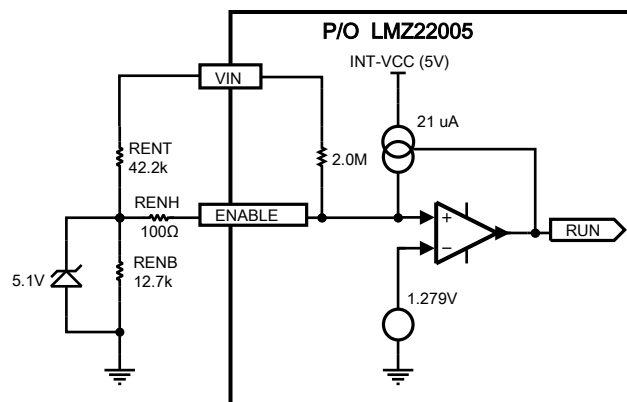

Figure 46. Enable Input Detail

## OUTPUT VOLTAGE SELECTION

Output voltage is determined by a divider of two resistors connected between  $V_O$  and ground. The midpoint of the divider is connected to the FB input.

The regulated output voltage determined by the external divider resistors  $R_{FBT}$  and  $R_{FBB}$  is:

$$V_O = 0.8V * (1 + R_{FBT} / R_{FBB}) \quad (2)$$

Rearranging terms; the ratio of the feedback resistors for a desired output voltage is:

$$R_{FBT} / R_{FBB} = (V_O / 0.796V) - 1 \quad (3)$$

These resistors should generally be chosen from values in the range of 1.0 kohm to 10.0 kohm.

For  $V_O = 0.8V$  the FB pin can be connected to the output directly and  $R_{FBB}$  can be omitted.

A table of values for  $R_{FBT}$ , and  $R_{FBB}$ , is included in the applications schematic.

## SOFT-START CAPACITOR SELECTION

Programmable soft-start permits the regulator to slowly ramp to its steady state operating point after being enabled, thereby reducing current inrush from the input supply and slowing the output voltage rise-time.

Upon turn-on, after all UVLO conditions have been passed, an internal 2 mSec circuit slowly ramps the SS/TRK input to implement internal soft start. If 1.6mSec is an adequate turn-on time then the  $C_{SS}$  capacitor can be left unpopulated. Longer soft-start periods are achieved by adding an external capacitor to this input.

Soft start duration is given by the formula:

$$t_{SS} = V_{REF} * C_{SS} / I_{SS} = 0.796V * C_{SS} / 50\mu A \quad (4)$$

This equation can be rearranged as follows:

$$C_{SS} = t_{SS} * 50\mu A / 0.796V \quad (5)$$

Using a 0.22 $\mu$ F capacitor results in 3.5 msec typical soft-start duration; and 0.47 $\mu$ F results in 7.5 msec typical. 0.47  $\mu$ F is a recommended initial value.

Once the soft-start input exceeds 0.796V the output of the power stage will be in regulation and the 50  $\mu$ A current is deactivated. Note that the following conditions will reset the soft-start capacitor by discharging the SS input to ground with an internal current sink.

- The Enable input being pulled low
- Thermal shutdown condition
- Internal  $V_{CC}$  UVLO (Approx 4.3V input to  $V_{IN}$ )

## TRACKING SUPPLY DIVIDER OPTION

The tracking function allows the module to be connected as a slave supply to a primary voltage rail (often the 3.3V system rail) where the slave module output voltage is lower than that of the master. Proper configuration allows the slave rail to power up coincident with the master rail such that the voltage difference between the rails during ramp-up is small (i.e. <0.15V typ). The values for the tracking resistive divider should be selected such that the effect of the internal 50 $\mu$ A current source is minimized. In most cases the ratio of the tracking divider resistors is the same as the ratio of the output voltage setting divider. Proper operation in tracking mode dictates the soft-start time of the slave rail be shorter than the master rail; a condition that is easy satisfy since the  $C_{SS}$  cap is replaced by  $R_{TKB}$ . The tracking function is only supported for the power up interval of the master supply; once the SS/TRK rises past 0.8V the input is no longer enabled and the 50  $\mu$ A internal current source is switched off.

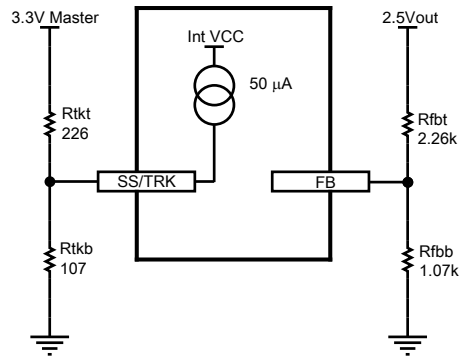

Figure 47. Tracking Option Input Detail

## C<sub>O</sub> SELECTION

None of the required C<sub>O</sub> output capacitance is contained within the module. A minimum value of 200 µF is required based on the values of internal compensation in the error amplifier. Low ESR tantalum, organic semiconductor or specialty polymer capacitor types are recommended for obtaining lowest ripple. The output capacitor C<sub>O</sub> may consist of several capacitors in parallel placed in close proximity to the module. The output capacitor assembly must also meet the worst case minimum ripple current rating of 0.5 \* I<sub>LR P-P</sub>, as calculated in Equation 14 below. Beyond that, additional capacitance will reduce output ripple so long as the ESR is low enough to permit it. Loop response verification is also valuable to confirm closed loop behavior.

For applications with dynamic load steps; the following equation provides a good first pass approximation of C<sub>O</sub> for load transient requirements. Where V<sub>O-Tran</sub> is 100mV on a 3.3V output design.

$$C_O \geq I_{O-Tran} * ((V_{O-Tran} - ESR * I_{O-Tran}) * (F_{SW} / V_O)) \quad (6)$$

Solving:

$$C_O \geq 4.5A / ((0.1V - .007 * 4.5A) * (800000HZ / 3.3V)) \geq 271\mu F \quad (7)$$

Note that the stability requirement for 200 µF minimum output capacitance will take precedence.

One recommended output capacitor combination is a 220µF, 7 milliohm ESR specialty polymer cap in parallel with a 100 µF 6.3V X5R ceramic. This combination provides excellent performance that may exceed the requirements of certain applications. Additionally some small ceramic capacitors can be used for high frequency EMI suppression.

## C<sub>IN</sub> SELECTION

The LMZ22005 module contains only a small amount of input capacitance. Additional input capacitance is required external to the module to handle the input ripple current of the application. The input capacitor can be several capacitors in parallel. This input capacitance should be located in very close proximity to the module. Input capacitor selection is generally directed to satisfy the input ripple current requirements rather than by capacitance value. Input ripple current rating is dictated by the equation:

$$I(C_{IN(RMS)}) \approx 1/2 * I_O * \text{SQRT}(D / (1-D)) \quad (8)$$

where  $D \approx V_O / V_{IN}$

(As a point of reference, the worst case ripple current will occur when the module is presented with full load current and when  $V_{IN} = 2 * V_O$ ).

Recommended minimum input capacitance is 22µF X7R (or X5R) ceramic with a voltage rating at least 25% higher than the maximum applied input voltage for the application. It is also recommended that attention be paid to the voltage and temperature derating of the capacitor selected. It should be noted that ripple current rating of ceramic capacitors may be missing from the capacitor data sheet and you may have to contact the capacitor manufacturer for this parameter.

If the system design requires a certain minimum value of peak-to-peak input ripple voltage ( $\Delta V_{IN}$ ) be maintained then the following equation may be used.

$$C_{IN} \geq I_O * D * (1-D) / f_{SW-CCM} * \Delta V_{IN} \quad (9)$$

If  $\Delta V_{IN}$  is 1% of  $V_{IN}$  for a 12V input to 3.3V output application this equals 120 mV and  $f_{SW} = 812$  kHz.

$$C_{IN} \geq 5A * 3.3V/12V * (1 - 3.3V/12V) / (812000 * 0.120 V) \\ \geq 10.2\mu F$$

Additional bulk capacitance with higher ESR may be required to damp any resonant effects of the input capacitance and parasitic inductance of the incoming supply lines. The LMZ22005 typical applications schematic recommends a 150  $\mu F$  50V aluminum capacitor for this function. There are many situations where this capacitor is not necessary.

## POWER DISSIPATION AND BOARD THERMAL REQUIREMENTS

When calculating module dissipation use the maximum input voltage and the average output current for the application. Many common operating conditions are provided in the characteristic curves such that less common applications can be derived through interpolation. In all designs, the junction temperature must be kept below the rated maximum of 125°C.

For the design case of  $V_{IN} = 12V$ ,  $V_O = 3.3V$ ,  $I_O = 5A$ , and  $T_{AMB(MAX)} = 85^\circ C$ , the module must see a thermal resistance from case to ambient of less than:

$$\theta_{CA} < (T_{J-MAX} - T_{A-MAX}) / P_{IC-LOSS} - \theta_{JC} \quad (10)$$

Given the typical thermal resistance from junction to case to be 1.9 °C/W. Use the 85°C power dissipation curves in the Typical Performance Characteristics section to estimate the  $P_{IC-LOSS}$  for the application being designed. In this application it is 4.3W.

$$\theta_{CA} = (125 - 85) / 4.3W - 1.9 = 7.4 \quad (11)$$

To reach  $\theta_{CA} = 7.4$ , the PCB is required to dissipate heat effectively. With no airflow and no external heat-sink, a good estimate of the required board area covered by 2 oz. copper on both the top and bottom metal layers is:

$$Board\_Area\_cm^2 = 500^\circ C * cm^2/W / \theta_{CA} \quad (12)$$

As a result, approximately 67square cm of 2 oz copper on top and bottom layers is required for the PCB design. The PCB copper heat sink must be connected to the exposed pad. Approximately sixty, 10mils (254  $\mu m$ ) thermal vias spaced 39 mils (1.0 mm) apart connect the top copper to the bottom copper. For an example of a high thermal performance PCB layout for SIMPLE SWITCHER® power modules, refer to AN-2085, AN-2125, AN-2020 and AN-2026.

## PC BOARD LAYOUT GUIDELINES

PC board layout is an important part of DC-DC converter design. Poor board layout can disrupt the performance of a DC-DC converter and surrounding circuitry by contributing to EMI, ground bounce and resistive voltage drop in the traces. These can send erroneous signals to the DC-DC converter resulting in poor regulation or instability. Good layout can be implemented by following a few simple design rules. A good example layout is shown in [Figure 51](#).

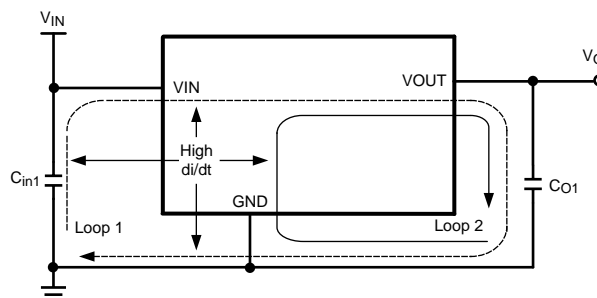

Figure 48.

### 1. Minimize area of switched current loops.

From an EMI reduction standpoint, it is imperative to minimize the high di/dt paths during PC board layout as shown in [Figure 48](#) above. The high current loops that do not overlap have high di/dt content that will cause observable high frequency noise on the output pin if the input capacitor ( $C_{IN1}$ ) is placed at a distance away from the LMZ22005. Therefore place  $C_{IN1}$  as close as possible to the LMZ22005 VIN and PGND exposed pad. This will minimize the high di/dt area and reduce radiated EMI. Additionally, grounding for both the input and output capacitor should consist of a localized top side plane that connects to the PGND exposed pad (EP).

### 2. Have a single point ground.

The ground connections for the feedback, soft-start, and enable components should be routed to the AGND pin of the device. This prevents any switched or load currents from flowing in the analog ground traces. If not properly handled, poor grounding can result in degraded load regulation or erratic output voltage ripple behavior. Additionally provide the single point ground connection from pin 4 (AGND) to EP/PGND.

### 3. Minimize trace length to the FB pin.

Both feedback resistors,  $R_{FBT}$  and  $R_{FBB}$ , and the feed forward capacitor  $C_{FF}$ , should be located close to the FB pin. Since the FB node is high impedance, maintain the copper area as small as possible. The traces from  $R_{FBT}$ ,  $R_{FBB}$ , and  $C_{FF}$  should be routed away from the body of the LMZ22005 to minimize possible noise pickup.

### 4. Make input and output bus connections as wide as possible.

This reduces any voltage drops on the input or output of the converter and maximizes efficiency. To optimize voltage accuracy at the load, ensure that a separate feedback voltage sense trace is made to the load. Doing so will correct for voltage drops and provide optimum output accuracy.

### 5. Provide adequate device heat-sinking.

Use an array of heat-sinking vias to connect the exposed pad to the ground plane on the bottom PCB layer. If the PCB has a plurality of copper layers, these thermal vias can also be employed to make connection to inner layer heat-spreading ground planes. For best results use a 6 x 10 via array with minimum via diameter of 10mils (254  $\mu$ m) thermal vias spaced 39mils (1.0 mm). Ensure enough copper area is used for heat-sinking to keep the junction temperature below 125°C.

## Additional Features

### SYNCHRONIZATION INPUT

The PWM switching frequency can be synchronized to an external frequency source. If this feature is not used, connect this input either directly to ground, or connect to ground through a resistor of 1.5 k $\Omega$  ohm or less. The allowed synchronization frequency range is 650kHz to 950 kHz. The typical input threshold is 1.4V transition level. Ideally the input clock should overdrive the threshold by a factor of 2, so direct drive from 3.3V logic via a 1.5k $\Omega$  Thevenin source resistance is recommended. Note that applying a sustained "logic 1" corresponds to zero Hz PWM frequency and will cause the module to stop switching.

### OUTPUT OVER-VOLTAGE PROTECTION

If the voltage at FB is greater than the 0.86V internal reference the output of the error amplifier is pulled toward ground causing  $V_O$  to fall.

### CURRENT LIMIT

The LMZ22005 is protected by both low side (LS) and high side (HS) current limit circuitry. The LS current limit detection is carried out during the off-time by monitoring the current through the LS synchronous MOSFET. Referring to the Functional Block Diagram, when the top MOSFET is turned off, the inductor current flows through the load, the PGND pin and the internal synchronous MOSFET. If this current exceeds 5.4A (typical) the current limit comparator disables the start of the next switching period. Switching cycles are prohibited until current drops below the limit. It should also be noted that d.c. current limit is dependent on duty cycle as illustrated in the graph in the typical performance section. The HS current limit monitors the current of top side MOSFET. Once HS current limit is detected (7A typical), the HS MOSFET is shutoff immediately, until the next cycle. Exceeding HS current limit causes  $V_O$  to fall. Typical behavior of exceeding LS current limit is that  $f_{SW}$  drops to 1/2 of the operating frequency.

## THERMAL PROTECTION

The junction temperature of the LMZ22005 should not be allowed to exceed its maximum ratings. Thermal protection is implemented by an internal thermal shutdown circuit which activates at 165 °C (typ) causing the device to enter a low power standby state. In this state the main MOSFET remains off causing  $V_O$  to fall, and additionally the  $C_{SS}$  capacitor is discharged to ground. Thermal protection helps prevent catastrophic failures for accidental device overheating. When the junction temperature falls back below 150 °C (typ Hyst = 15°C) the SS pin is released,  $V_O$  rises smoothly, and normal operation resumes.

Applications requiring maximum output current especially those at high input voltage may require additional derating at elevated temperatures.

## PRE-BIASED STARTUP

The LMZ22005 will properly start up into a pre-biased output. This startup situation is common in multiple rail logic applications where current paths may exist between different power rails during the startup sequence. The following scope capture shows proper behavior in this mode. Trace one is Enable going high. Trace two is 1.5V pre-bias rising to 3.3V. Rise time determined by  $C_{SS}$ , trace three.

**Figure 49. Pre-Biased Startup**

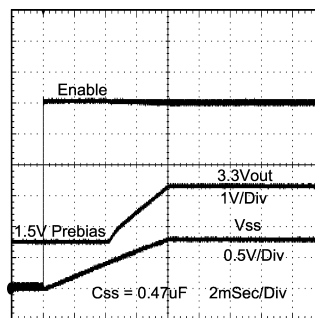

## DISCONTINUOUS AND CONTINUOUS CONDUCTION MODES

At light load the regulator will operate in discontinuous conduction mode (DCM). With load currents above the critical conduction point, it will operate in continuous conduction mode (CCM). In CCM, current flows through the inductor through the entire switching cycle and never falls to zero during the off-time. When operating in DCM, inductor current is maintained to an average value equaling  $I_{out}$ . Inductor current exhibits normal behavior for the emulated current mode control method used. Output voltage ripple typically increases during this mode of operation.

Following is a comparison pair of waveforms of the showing both CCM (upper) and DCM operating modes.

**Figure 50. CCM and DCM Operating Modes**  
 $V_{IN} = 12V$ ,  $V_O = 3.3V$ ,  $I_O = 3A/0.3A$  2  $\mu\text{sec/div}$

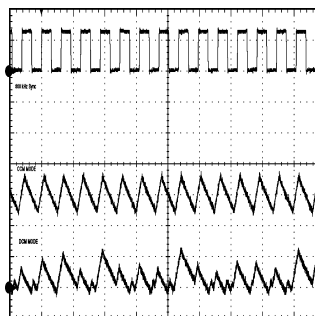

The approximate formula for determining the DCM/CCM boundary is as follows:

$$I_{DCB} \approx V_O \cdot (V_{IN} - V_O) / (2 \cdot 3.3 \mu\text{H} \cdot f_{SW(\text{CCM})} \cdot V_{IN}) \quad (13)$$

The inductor internal to the module is 3.3  $\mu$ H. This value was chosen as a good balance between low and high input voltage applications. The main parameter affected by the inductor is the amplitude of the inductor ripple current ( $I_{LR}$ ).  $I_{LR}$  can be calculated with:

$$I_{LR P-P} = V_O * (V_{IN} - V_O) / (3.3 \mu H * f_{SW} * V_{IN}) \tag{14}$$

Where  $V_{IN}$  is the maximum input voltage and  $f_{SW}$  is typically 812 kHz.

If the output current  $I_O$  is determined by assuming that  $I_O = I_L$ , the higher and lower peak of  $I_{LR}$  can be determined.

**Typical Application Schematic Diagram**

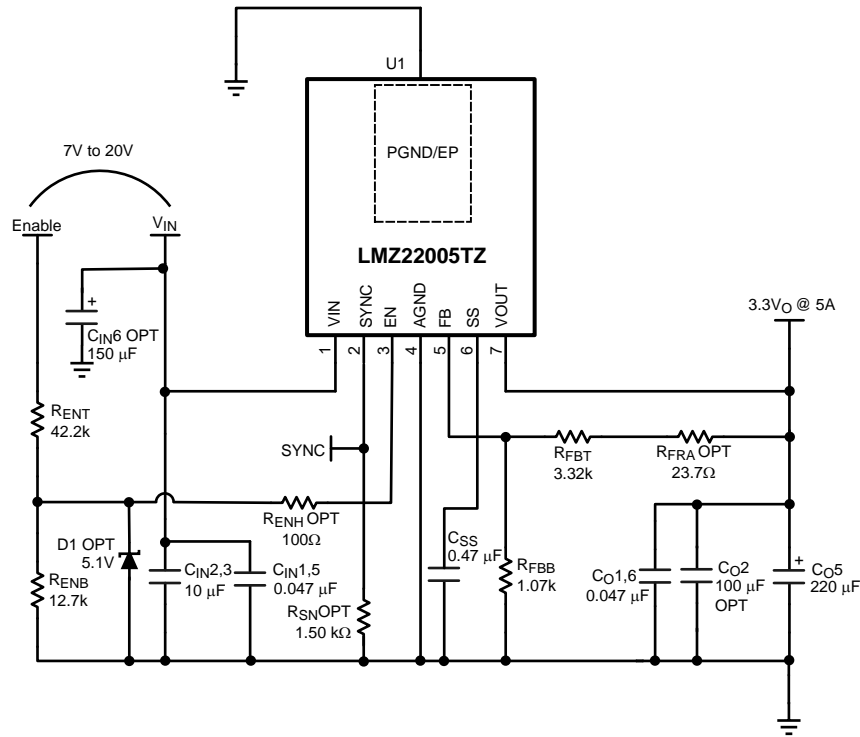

**Table 1. Typical Application Bill of Materials**

Ref Des	Description	Case Size	Manufacturer	Manufacturer P/N
U1	SIMPLE SWITCHER®	PFM-7	Texas Instruments	LMZ22005TZ
C <sub>in1,5</sub>	0.047 µF, 50V, X7R	1206	Yageo America	CC1206KRX7R9BB473
C <sub>in2,3</sub>	10 µF, 50V, X7R	1210	Taiyo Yuden	UMK325BJ106MM-T
C <sub>in6</sub> (OPT)	CAP, AL, 150µF, 50V	Radial G	Panasonic	EEE-FK1H151P
C <sub>O1,6</sub>	0.047 µF, 50V, X7R	1206	Yageo America	CC1206KRX7R9BB473
C <sub>O2</sub> (OPT)	100 µF, 6.3V, X7R	1210	TDK	C3225X5R0J107M
C <sub>O5</sub>	220 µF, 6.3V, SP-Cap	(7343)	Panasonic	EEF-UE0J221LR
R <sub>FBT</sub>	3.32 kΩ	0805	Panasonic	ERJ-6ENF3321V
R <sub>FBB</sub>	1.07 kΩ	0805	Panasonic	ERJ-6ENF1071V
R <sub>SN</sub> (OPT)	1.50 kΩ	0805	Vishay Dale	CRCW08051K50FKEA
R <sub>ENT</sub>	42.2 kΩ	0805	Panasonic	ERJ-6ENF4222V
R <sub>ENB</sub>	12.7 kΩ	0805	Panasonic	ERJ-6ENF1272V
R <sub>FRA</sub> (OPT)	23.7Ω	0805	Vishay Dale	CRCW080523R7FKEA
R <sub>ENH</sub>	100 Ω	0805	Vishay Dale	CRCW0805100RFKEA
C <sub>FF</sub>	180 pF, ±10%, COG, 50V	0805	TDK	08055A181JAT2A
C <sub>SS</sub>	047 µF, ±10%, X7R, 16V	0805	AVX	0805YC474KAT2A
D1(OPT)	5.1V, 0.5W	SOD-123	Diodes Inc.	MMSZ5231BS-7-F

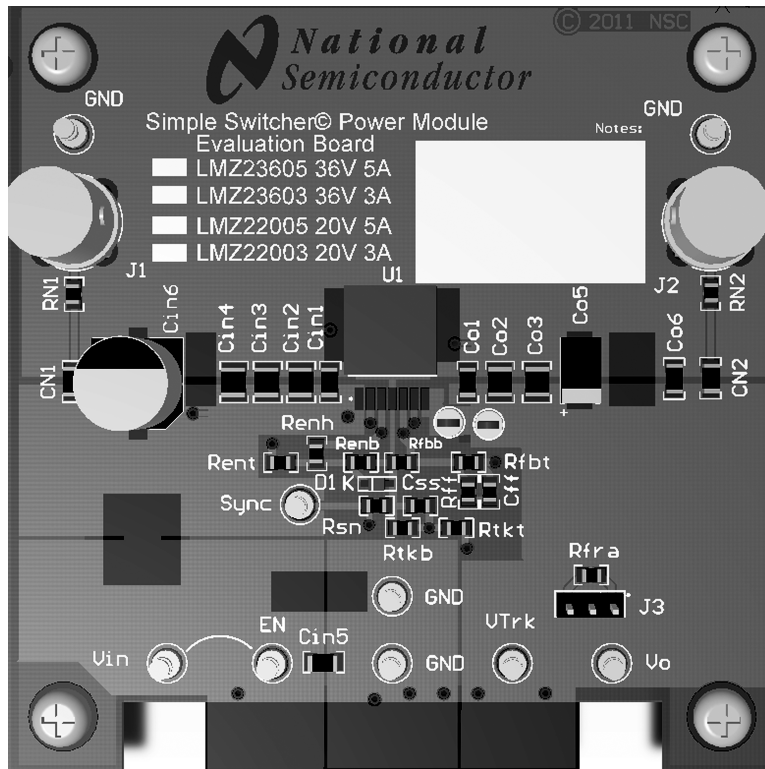

**Figure 51. Top View Evaluation Board – See AN-2085 [SNVA457](#)**

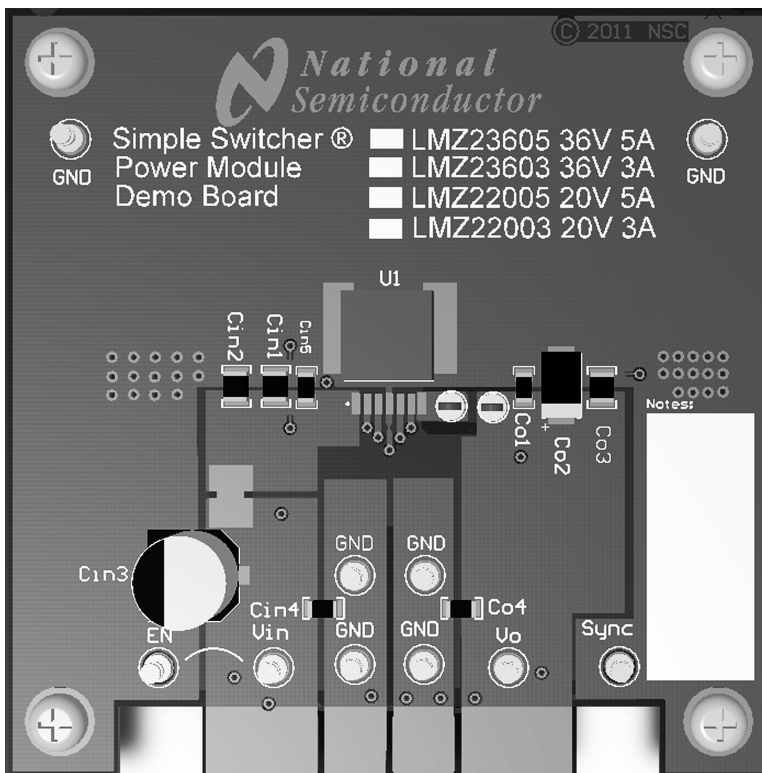

Figure 52. Top View Demonstration Board – See AN–2125 [SNVA473](#)

## REVISION HISTORY

Changes from Revision F (March 2013) to Revision G	Page
• Changed layout of National Data Sheet to TI format .....	<a href="#">23</a>

## PACKAGING INFORMATION

Orderable Device	Status (1)	Package Type	Package Drawing	Pins	Package Qty	Eco Plan (2)	Lead/Ball Finish	MSL Peak Temp (3)	Op Temp (°C)	Top-Side Markings (4)	Samples
LMZ22005TZ/NOPB	ACTIVE	PFM	NDW	7	45	Green (RoHS & no Sb/Br)	CU SN	Level-3-245C-168 HR		LMZ22005	<a href="#">Samples</a>
LMZ22005TZE/NOPB	ACTIVE	PFM	NDW	7	250	Green (RoHS & no Sb/Br)	CU SN	Level-3-245C-168 HR		LMZ22005	<a href="#">Samples</a>
LMZ22005TZX/NOPB	ACTIVE	PFM	NDW	7	500	Green (RoHS & no Sb/Br)	CU SN	Level-3-245C-168 HR		LMZ22005	<a href="#">Samples</a>

(1) The marketing status values are defined as follows:

**ACTIVE:** Product device recommended for new designs.

**LIFEBUY:** TI has announced that the device will be discontinued, and a lifetime-buy period is in effect.

**NRND:** Not recommended for new designs. Device is in production to support existing customers, but TI does not recommend using this part in a new design.

**PREVIEW:** Device has been announced but is not in production. Samples may or may not be available.

**OBSOLETE:** TI has discontinued the production of the device.

(2) Eco Plan - The planned eco-friendly classification: Pb-Free (RoHS), Pb-Free (RoHS Exempt), or Green (RoHS & no Sb/Br) - please check <http://www.ti.com/productcontent> for the latest availability information and additional product content details.

**TBD:** The Pb-Free/Green conversion plan has not been defined.

**Pb-Free (RoHS):** TI's terms "Lead-Free" or "Pb-Free" mean semiconductor products that are compatible with the current RoHS requirements for all 6 substances, including the requirement that lead not exceed 0.1% by weight in homogeneous materials. Where designed to be soldered at high temperatures, TI Pb-Free products are suitable for use in specified lead-free processes.

**Pb-Free (RoHS Exempt):** This component has a RoHS exemption for either 1) lead-based flip-chip solder bumps used between the die and package, or 2) lead-based die adhesive used between the die and leadframe. The component is otherwise considered Pb-Free (RoHS compatible) as defined above.

**Green (RoHS & no Sb/Br):** TI defines "Green" to mean Pb-Free (RoHS compatible), and free of Bromine (Br) and Antimony (Sb) based flame retardants (Br or Sb do not exceed 0.1% by weight in homogeneous material)

(3) MSL, Peak Temp. -- The Moisture Sensitivity Level rating according to the JEDEC industry standard classifications, and peak solder temperature.

(4) Only one of markings shown within the brackets will appear on the physical device.

**Important Information and Disclaimer:** The information provided on this page represents TI's knowledge and belief as of the date that it is provided. TI bases its knowledge and belief on information provided by third parties, and makes no representation or warranty as to the accuracy of such information. Efforts are underway to better integrate information from third parties. TI has taken and continues to take reasonable steps to provide representative and accurate information but may not have conducted destructive testing or chemical analysis on incoming materials and chemicals. TI and TI suppliers consider certain information to be proprietary, and thus CAS numbers and other limited information may not be available for release.

In no event shall TI's liability arising out of such information exceed the total purchase price of the TI part(s) at issue in this document sold by TI to Customer on an annual basis.

**TAPE AND REEL INFORMATION**

**QUADRANT ASSIGNMENTS FOR PIN 1 ORIENTATION IN TAPE**

\*All dimensions are nominal

Device	Package Type	Package Drawing	Pins	SPQ	Reel Diameter (mm)	Reel Width W1 (mm)	A0 (mm)	B0 (mm)	K0 (mm)	P1 (mm)	W (mm)	Pin1 Quadrant
LMZ22005TZE/NOPB	PFM	NDW	7	250	330.0	24.4	10.6	14.22	5.0	16.0	24.0	Q2
LMZ22005TZX/NOPB	PFM	NDW	7	500	330.0	24.4	10.6	14.22	5.0	16.0	24.0	Q2

**TAPE AND REEL BOX DIMENSIONS**

\*All dimensions are nominal

Device	Package Type	Package Drawing	Pins	SPQ	Length (mm)	Width (mm)	Height (mm)
LMZ22005TZE/NOPB	PFM	NDW	7	250	367.0	367.0	45.0
LMZ22005TZX/NOPB	PFM	NDW	7	500	367.0	367.0	45.0

NDW0007A

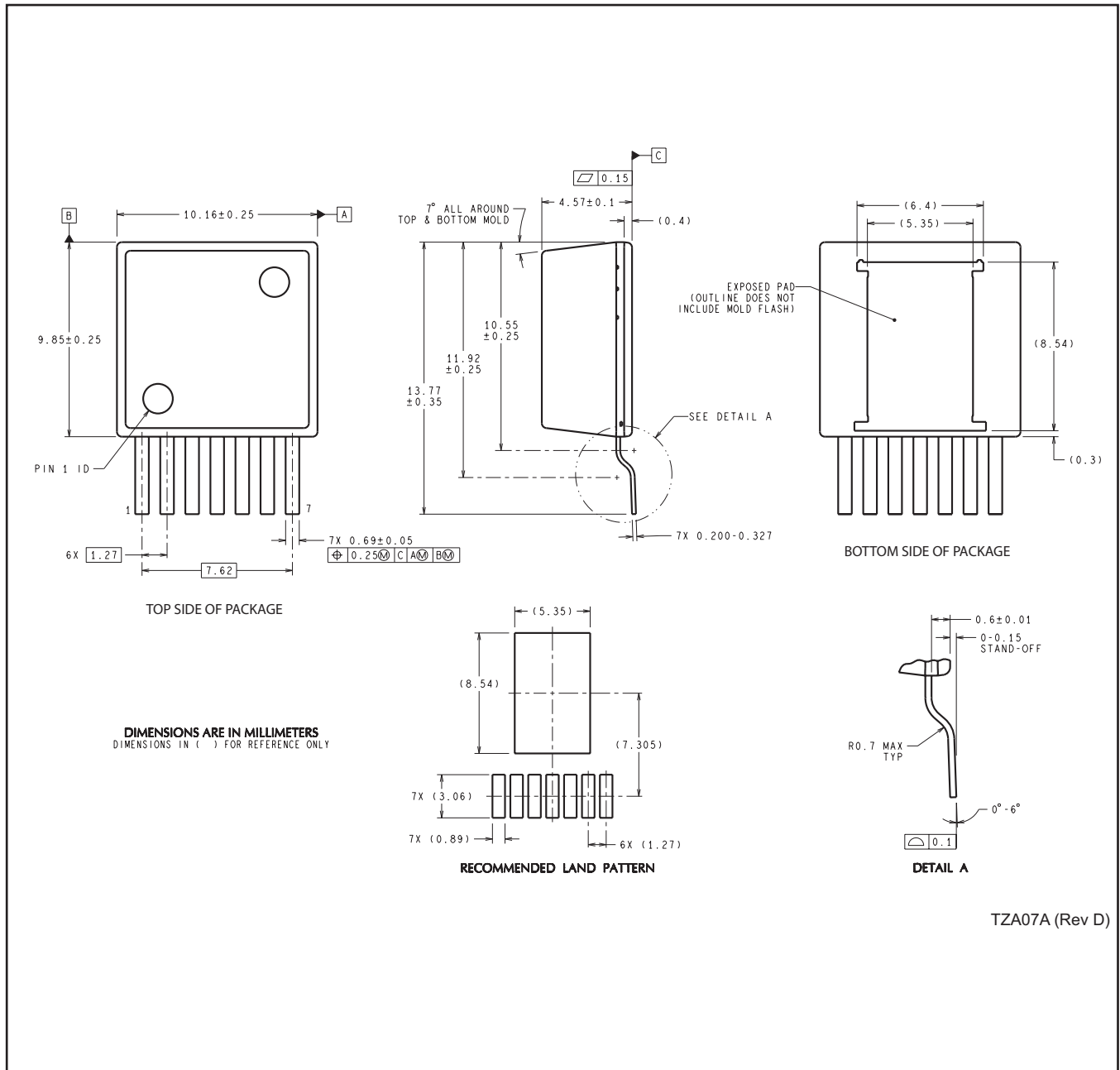

TZA07A (Rev D)

## IMPORTANT NOTICE

Texas Instruments Incorporated and its subsidiaries (TI) reserve the right to make corrections, enhancements, improvements and other changes to its semiconductor products and services per JESD46, latest issue, and to discontinue any product or service per JESD48, latest issue. Buyers should obtain the latest relevant information before placing orders and should verify that such information is current and complete. All semiconductor products (also referred to herein as "components") are sold subject to TI's terms and conditions of sale supplied at the time of order acknowledgment.

TI warrants performance of its components to the specifications applicable at the time of sale, in accordance with the warranty in TI's terms and conditions of sale of semiconductor products. Testing and other quality control techniques are used to the extent TI deems necessary to support this warranty. Except where mandated by applicable law, testing of all parameters of each component is not necessarily performed.

TI assumes no liability for applications assistance or the design of Buyers' products. Buyers are responsible for their products and applications using TI components. To minimize the risks associated with Buyers' products and applications, Buyers should provide adequate design and operating safeguards.

TI does not warrant or represent that any license, either express or implied, is granted under any patent right, copyright, mask work right, or other intellectual property right relating to any combination, machine, or process in which TI components or services are used. Information published by TI regarding third-party products or services does not constitute a license to use such products or services or a warranty or endorsement thereof. Use of such information may require a license from a third party under the patents or other intellectual property of the third party, or a license from TI under the patents or other intellectual property of TI.

Reproduction of significant portions of TI information in TI data books or data sheets is permissible only if reproduction is without alteration and is accompanied by all associated warranties, conditions, limitations, and notices. TI is not responsible or liable for such altered documentation. Information of third parties may be subject to additional restrictions.

Resale of TI components or services with statements different from or beyond the parameters stated by TI for that component or service voids all express and any implied warranties for the associated TI component or service and is an unfair and deceptive business practice. TI is not responsible or liable for any such statements.

Buyer acknowledges and agrees that it is solely responsible for compliance with all legal, regulatory and safety-related requirements concerning its products, and any use of TI components in its applications, notwithstanding any applications-related information or support that may be provided by TI. Buyer represents and agrees that it has all the necessary expertise to create and implement safeguards which anticipate dangerous consequences of failures, monitor failures and their consequences, lessen the likelihood of failures that might cause harm and take appropriate remedial actions. Buyer will fully indemnify TI and its representatives against any damages arising out of the use of any TI components in safety-critical applications.

In some cases, TI components may be promoted specifically to facilitate safety-related applications. With such components, TI's goal is to help enable customers to design and create their own end-product solutions that meet applicable functional safety standards and requirements. Nonetheless, such components are subject to these terms.

No TI components are authorized for use in FDA Class III (or similar life-critical medical equipment) unless authorized officers of the parties have executed a special agreement specifically governing such use.

Only those TI components which TI has specifically designated as military grade or "enhanced plastic" are designed and intended for use in military/aerospace applications or environments. Buyer acknowledges and agrees that any military or aerospace use of TI components which have **not** been so designated is solely at the Buyer's risk, and that Buyer is solely responsible for compliance with all legal and regulatory requirements in connection with such use.

TI has specifically designated certain components as meeting ISO/TS16949 requirements, mainly for automotive use. In any case of use of non-designated products, TI will not be responsible for any failure to meet ISO/TS16949.

### Products

Audio	<a href="http://www.ti.com/audio">www.ti.com/audio</a>
Amplifiers	<a href="http://amplifier.ti.com">amplifier.ti.com</a>
Data Converters	<a href="http://dataconverter.ti.com">dataconverter.ti.com</a>
DLP® Products	<a href="http://www.dlp.com">www.dlp.com</a>
DSP	<a href="http://dsp.ti.com">dsp.ti.com</a>
Clocks and Timers	<a href="http://www.ti.com/clocks">www.ti.com/clocks</a>
Interface	<a href="http://interface.ti.com">interface.ti.com</a>
Logic	<a href="http://logic.ti.com">logic.ti.com</a>
Power Mgmt	<a href="http://power.ti.com">power.ti.com</a>
Microcontrollers	<a href="http://microcontroller.ti.com">microcontroller.ti.com</a>
RFID	<a href="http://www.ti-rfid.com">www.ti-rfid.com</a>
OMAP Applications Processors	<a href="http://www.ti.com/omap">www.ti.com/omap</a>
Wireless Connectivity	<a href="http://www.ti.com/wirelessconnectivity">www.ti.com/wirelessconnectivity</a>

### Applications

Automotive and Transportation	<a href="http://www.ti.com/automotive">www.ti.com/automotive</a>
Communications and Telecom	<a href="http://www.ti.com/communications">www.ti.com/communications</a>
Computers and Peripherals	<a href="http://www.ti.com/computers">www.ti.com/computers</a>
Consumer Electronics	<a href="http://www.ti.com/consumer-apps">www.ti.com/consumer-apps</a>
Energy and Lighting	<a href="http://www.ti.com/energy">www.ti.com/energy</a>
Industrial	<a href="http://www.ti.com/industrial">www.ti.com/industrial</a>
Medical	<a href="http://www.ti.com/medical">www.ti.com/medical</a>
Security	<a href="http://www.ti.com/security">www.ti.com/security</a>
Space, Avionics and Defense	<a href="http://www.ti.com/space-avionics-defense">www.ti.com/space-avionics-defense</a>
Video and Imaging	<a href="http://www.ti.com/video">www.ti.com/video</a>

### TI E2E Community

[e2e.ti.com](http://e2e.ti.com)