

# LMZ21700 650 mA SIMPLE SWITCHER® Nano Module with 17 V Maximum Input Voltage

## 1 Features

- Integrated Inductor
- Miniature 3.5 mm x 3.5 mm x 1.75 mm Package
- [35 mm<sup>2</sup> Solution Size \(Single Sided\)](#)
- -40 °C to 125 °C Junction Temperature Range
- Adjustable Output Voltage
- Integrated Compensation
- Adjustable Soft Start Function
- Starts into Pre-Biased Loads
- Power Good and Enable Pins
- Seamless Transition to Power-Save Mode
- Up to 650 mA Output Current
- Input Voltage Range 3 V to 17 V
- Output Voltage Range 0.9 V to 6 V
- Efficiency up to 95 %
- 1.5  $\mu$ A Shutdown Current
- 17  $\mu$ A Quiescent Current

## 2 Applications

- Point of Load Conversions from 3.3 V, 5 V, or 12 V Input Voltage
- Space Constrained Applications
- LDO Replacement

## 3 Description

The LMZ21700 SIMPLE SWITCHER® Nano Module is an easy-to-use step-down DC-DC solution capable of driving up to 650 mA load in space-constrained applications. Only an input capacitor, an output capacitor, a softstart capacitor, and two resistors are required for basic operation.

Quick links to typical applications: [V<sub>OUT</sub> = 1.2 V](#), [V<sub>OUT</sub> = 1.8 V](#), [V<sub>OUT</sub> = 2.5 V](#), [V<sub>OUT</sub> = 3.3 V](#), [V<sub>OUT</sub> = 5.0 V](#)

**Table 1. Device Information<sup>(1)</sup>**

PART NUMBER	PACKAGE	BODY SIZE (NOM)
LMZ21700SILT	SIL0008E	3.5 mm x 3.5 mm

(1) For all available packages, see the orderable addendum at the end of the datasheet.

## 4 Simplified Schematic

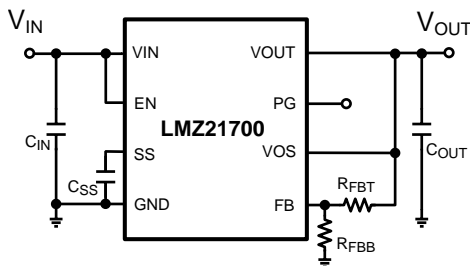

**Figure 1. Efficiency for V<sub>IN</sub> = 12 V**

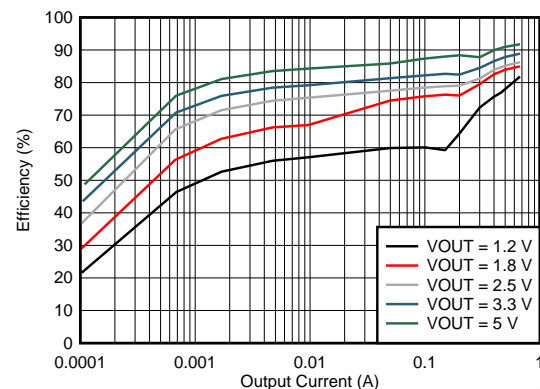

## Table of Contents

<b>1 Features</b> .....	<b>1</b>	8.5 Device Functional Modes.....	<b>11</b>
<b>2 Applications</b> .....	<b>1</b>	<b>9 Application and Implementation</b> .....	<b>11</b>
<b>3 Description</b> .....	<b>1</b>	9.1 Application Information.....	<b>11</b>
<b>4 Simplified Schematic</b> .....	<b>1</b>	9.2 Typical Application .....	<b>11</b>
<b>5 Revision History</b> .....	<b>2</b>	9.3 Do's and Don'ts .....	<b>24</b>
<b>6 Pin Configuration and Functions</b> .....	<b>3</b>	<b>10 Power Supply Recommendations</b> .....	<b>24</b>
<b>7 Specifications</b> .....	<b>4</b>	10.1 Voltage Range .....	<b>24</b>
7.1 Absolute Maximum Ratings .....	<b>4</b>	10.2 Current Capability .....	<b>24</b>
7.2 Handling Ratings.....	<b>4</b>	10.3 Input Connection .....	<b>24</b>
7.3 Recommended Operating Conditions.....	<b>4</b>	<b>11 Layout</b> .....	<b>25</b>
7.4 Thermal Information .....	<b>4</b>	11.1 Layout Guidelines .....	<b>25</b>
7.5 Electrical Characteristics.....	<b>5</b>	11.2 Layout Example .....	<b>26</b>
7.6 Typical Characteristics .....	<b>6</b>	<b>12 Device and Documentation Support</b> .....	<b>29</b>
<b>8 Detailed Description</b> .....	<b>8</b>	12.1 Device Support .....	<b>29</b>
8.1 Overview .....	<b>8</b>	12.2 Trademarks .....	<b>29</b>
8.2 Functional Block Diagram .....	<b>8</b>	12.3 Electrostatic Discharge Caution.....	<b>29</b>
8.3 Package Construction .....	<b>9</b>	12.4 Glossary .....	<b>29</b>
8.4 Feature Description.....	<b>9</b>	<b>13 Mechanical, Packaging, and Orderable Information</b> .....	<b>29</b>

## 5 Revision History

NOTE: Page numbers for previous revisions may differ from page numbers in the current version.

<b>Changes from Revision splat (August 2012) to Revision A</b>	<b>Page</b>
• Changed Description .....	<b>1</b>

---

<b>Changes from Revision A (October 2013) to Revision B</b>	<b>Page</b>
• Added <i>Device Information and Handling Rating tables, Feature Description, Application and Implementation Layout Device and Documentation Support and Mechanical, Packaging, and Orderable Information</i> , moved some curves to <i>Application Curves</i> .....	<b>1</b>
• Updated datasheet to new TI standards .....	<b>1</b>

---

<b>Changes from Revision B (October 2014) to Revision C</b>	<b>Page</b>
• Changed from Product Preview to Production Data .....	<b>1</b>
• Changed to Final Limits .....	<b>5</b>

## 6 Pin Configuration and Functions

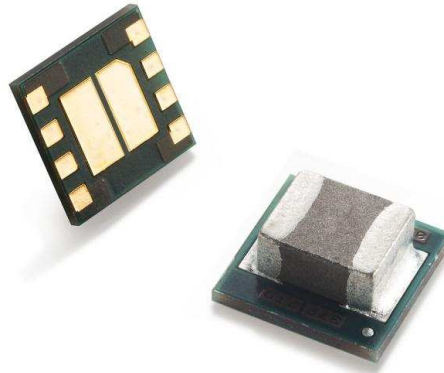

**Figure 2. LMZ21700 in the SIL0008E Package**

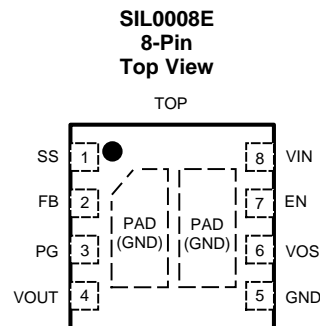

**Table 2. Pin Functions**

PIN		I/O	DESCRIPTION
NAME	NO.		
SS	1	I	Soft-start pin. An external capacitor connected to this pin sets the internal voltage reference ramp time. It can be used for tracking and sequencing.
FB	2	I	Voltage feedback. Connect resistive voltage divider to this pin to set the output voltage.
PG	3	O	Output power good (High = VOUT ready, Low = VOUT below nominal regulation); open drain (requires pull-up resistor; goes low impedance when EN is low)
VOUT	4	O	Output Voltage. Connected to one terminal of the integrated inductor. Connect output filter capacitor between VOUT and PGND.
GND	5	I	Ground for the power MOSFETs and gate-drive circuitry.
VOS	6	I	Output voltage sense pin and connection for the control loop circuitry.
EN	7	I	Enable input (High = enabled, Low = disabled). Internal pull down resistor keeps logic level low if pin is left floating
VIN	8	I	Supply voltage for control circuitry and power stage.
PAD			Electrically connected to GND. Must be soldered to a ground copper plane to achieve appropriate power dissipation and mechanical reliability.

## 7 Specifications

### 7.1 Absolute Maximum Ratings

Over operating free-air temperature range (unless otherwise noted)<sup>(1)(2)</sup>

	MIN	MAX	UNIT
V <sub>IN</sub>	-0.3	20	V
EN, SS	-0.3	V <sub>IN</sub> +0.3 V w/ 20 V max	V
FB, PG, VOS	-0.3	7	V
PG sink current		10	mA
Junction Temperature (T <sub>J-MAX</sub> )	-40	125	°C
Maximum Lead Temperature		260	°C

- (1) Stresses beyond those listed under *Absolute Maximum Ratings* may cause permanent damage to the device. These are stress ratings only, which do not imply functional operation of the device at these or any other conditions beyond those indicated under *Recommended Operating Conditions*. Exposure to absolute-maximum-rated conditions for extended periods may affect device reliability.
- (2) If Military/Aerospace specified devices are required, please contact the Texas Instruments Sales Office/ Distributors for availability and specifications.

### 7.2 Handling Ratings

		MIN	MAX	UNIT	
T <sub>stg</sub>	Storage temperature range	-65	150	°C	
V <sub>(ESD)</sub>	Electrostatic discharge	Human body model (HBM), per ANSI/ESDA/JEDEC JS-001, all pins <sup>(1)</sup>	-2000	2000	V
		Charged device model (CDM), per JEDEC specification JESD22-C101, all pins <sup>(2)</sup>	-500	500	

- (1) JEDEC document JEP155 states that 500-V HBM allows safe manufacturing with a standard ESD control process.
- (2) JEDEC document JEP157 states that 250-V CDM allows safe manufacturing with a standard ESD control process.

### 7.3 Recommended Operating Conditions

Over operating free-air temperature range (unless otherwise noted)<sup>(1)</sup>

	MIN	MAX	UNIT
Input Voltage Range	3	17	V
Output Voltage Range	0.9	6.0	V
Recommended Load Current	0	650	mA
Junction Temperature (T <sub>J</sub> )	-40	125	°C

- (1) Operating Ratings indicate conditions for which the device is intended to be functional, but do not guarantee specific performance limits. For guaranteed specifications, see the [Electrical Characteristics](#) section.

### 7.4 Thermal Information

THERMAL METRIC <sup>(1)</sup>		LMZ21700	UNIT
		SIL0008E	
		8 PINS	
R <sub>θJA</sub>	Junction-to-ambient thermal resistance <sup>(2)</sup>	42.6	°C/W
R <sub>θJC(top)</sub>	Junction-to-case (top) thermal resistance	20.8	
R <sub>θJB</sub>	Junction-to-board thermal resistance	9.4	
ψ <sub>JT</sub>	Junction-to-top characterization parameter	1.5	
ψ <sub>JB</sub>	Junction-to-board characterization parameter	9.3	
R <sub>θJC(bot)</sub>	Junction-to-case (bottom) thermal resistance	1.8	

- (1) For more information about traditional and new thermal metrics, see the *IC Package Thermal Metrics* application report, [SPRA953](#).
- (2) Junction-to-ambient thermal resistance (θ<sub>JA</sub>) is based on 4 layer board thermal measurements, performed under the conditions and guidelines set forth in the JEDEC standards JESD51-1 to JESD51-11. θ<sub>JA</sub> varies with PCB copper area, power dissipation, and airflow.

## 7.5 Electrical Characteristics<sup>(1)</sup>

Limits apply over the recommended operating junction temperature ( $T_J$ ) range of  $-40\text{ }^\circ\text{C}$  to  $+125\text{ }^\circ\text{C}$ , unless otherwise stated. Minimum and Maximum limits are specified through test, design or statistical correlation. Typical values represent the most likely parametric norm at  $T_J = 25\text{ }^\circ\text{C}$ , and are provided for reference purposes only. Unless otherwise stated the following conditions apply:  $V_{IN} = 12\text{ V}$ .

PARAMETER	TEST CONDITIONS	MIN <sup>(1)</sup>	TYP <sup>(2)</sup>	MAX <sup>(1)</sup>	UNIT		
<b>SYSTEM PARAMETERS</b>							
$I_Q$	Operating quiescent current	EN = high, $I_{OUT} = 0\text{ mA}$ , $T_J = -40\text{ }^\circ\text{C}$ to $85\text{ }^\circ\text{C}$ device not switching	17	25	$\mu\text{A}$		
		EN = high, $I_{OUT} = 0\text{ mA}$ , $T_J = -40\text{ }^\circ\text{C}$ to $125\text{ }^\circ\text{C}$ device not switching	17	28	$\mu\text{A}$		
$I_{SD}$	Shutdown current	EN = low, $T_J = -40\text{ }^\circ\text{C}$ to $85\text{ }^\circ\text{C}$	1.5	4	$\mu\text{A}$		
		EN = low, $T_J = -40\text{ }^\circ\text{C}$ to $125\text{ }^\circ\text{C}$	1.5	5	$\mu\text{A}$		
$V_{INUVLO}$	Input under voltage lock out rising threshold	2.8	2.9	3	V		
$V_{INUVLO-HYS}$	Input under voltage lock out hysteresis	0.125	0.180	0.260	V		
$T_{SD}$	Thermal shutdown	Rising Threshold		160	$^\circ\text{C}$		
$T_{SD-HYST}$	Thermal shutdown hysteresis			30	$^\circ\text{C}$		
<b>CONTROL</b>							
$V_{IH\_ENABLE}$	Enable logic HIGH voltage			0.9	V		
$V_{IL\_ENABLE}$	Enable logic LOW voltage			0.3	V		
$I_{LKG}$	Input leakage current	EN = $V_{IN}$ or GND	0.01	1	$\mu\text{A}$		
$V_{TH\_PG}$	Power Good threshold voltage	Rising (% $V_{OUT}$ )	92 %	95 %	98 %		
		Falling (% $V_{OUT}$ )	87 %	90 %	93 %		
$V_{OL\_PG}$	Power Good output low voltage	$I_{PG} = -2\text{ mA}$	0.07	0.3	V		
$I_{LKG\_PG}$	Power Good leakage current	$V_{PG} = 1.8\text{ V}$	1	400	nA		
$I_{SS}$	Softstart Pin source current			2.2	2.5	2.8	$\mu\text{A}$
<b>POWER STAGE</b>							
$R_{DS(ON)}$	High-Side MOSFET ON Resistance	$V_{IN} \geq 6\text{ V}$	82		m $\Omega$		
		$V_{IN} = 3\text{ V}$	120				
	Low-Side MOSFET ON Resistance	$V_{IN} \geq 6\text{ V}$	40		m $\Omega$		
		$V_{IN} = 3\text{ V}$	50				
L	Integrated power inductor value			2.2	$\mu\text{H}$		
DCR	Integrated power inductor DC resistance			92	m $\Omega$		
$I_{CL-HS}$	High-Side MOSFET Current Limit	$T_A = 25\text{ }^\circ\text{C}$	1.2	1.5	1.9	A	
$I_{CL-LS}$	Low-Side MOSFET Current Limit	$T_A = 25\text{ }^\circ\text{C}$	0.9		A		
$I_{CL-DC}$	Output (DC) current limit	$V_{OUT} = 5.0\text{ V}$ , $T_A = 85\text{ }^\circ\text{C}$	0.95		A		
<b>OUTPUT</b>							
$V_{REF}$	Internal reference voltage			0.7869	0.803	0.8191	V
$I_{FB}$	Feedback pin leakage current	$V_{FB} = 0.8\text{ V}$	1		100	nA	
$V_{OUT}$	Light load initial voltage accuracy	Power save mode, $C_{OUT} = 22\text{ }\mu\text{F}$ , $T_A = -40\text{ }^\circ\text{C}$ to $85\text{ }^\circ\text{C}$ , 1% FB Resistors	-2.3 %	2.8 %			
$V_{OUT}$	Load regulation	$V_{OUT} = 3.3\text{ V}$ PWM mode operation	0.05 %		/ A		

(1) Min and Max limits are 100% production tested at  $25\text{ }^\circ\text{C}$ . Limits over the operating temperature range are guaranteed through correlation using Statistical Quality Control (SQC) methods. Limits are used to calculate National's Average Outgoing Quality Level (AOQL).

(2) Typical numbers are at  $25\text{ }^\circ\text{C}$  and represent the most likely parametric norm.

### Electrical Characteristics<sup>(1)</sup> (continued)

Limits apply over the recommended operating junction temperature ( $T_J$ ) range of  $-40\text{ }^\circ\text{C}$  to  $+125\text{ }^\circ\text{C}$ , unless otherwise stated. Minimum and Maximum limits are specified through test, design or statistical correlation. Typical values represent the most likely parametric norm at  $T_J = 25\text{ }^\circ\text{C}$ , and are provided for reference purposes only. Unless otherwise stated the following conditions apply:  $V_{IN} = 12\text{ V}$ .

PARAMETER	TEST CONDITIONS	MIN <sup>(1)</sup>	TYP <sup>(2)</sup>	MAX <sup>(1)</sup>	UNIT
$V_{OUT}$ Line regulation	$3\text{ V} \leq V_{IN} \leq 17\text{ V}$ , $V_{OUT} = 3.3\text{ V}$ , $I_{OUT} = 650\text{ mA}$ PWM mode operation		0.02 %		/ V
<b>SYSTEM CHARACTERISTICS</b>					
$\eta$	Full Load Efficiency	$V_{OUT} = 3.3\text{ V}$ , $I_{OUT} = 650\text{ mA}$	88 %		
	Light Load Efficiency	$V_{OUT} = 3.3\text{ V}$ , $I_{OUT} = 1\text{ mA}$	72 %		

### 7.6 Typical Characteristics

Unless otherwise specified the following conditions apply:  $V_{IN} = 12\text{ V}$ ,  $T_A = 25\text{ }^\circ\text{C}$

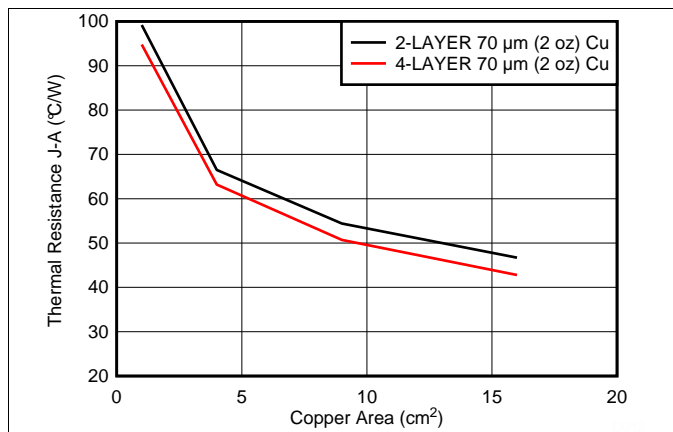

Figure 3. Package Thermal Resistance vs. Board Copper Area, No Air Flow

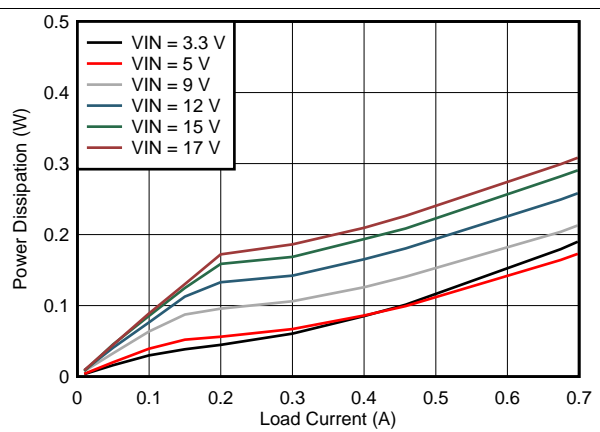

Figure 4. Power Dissipation

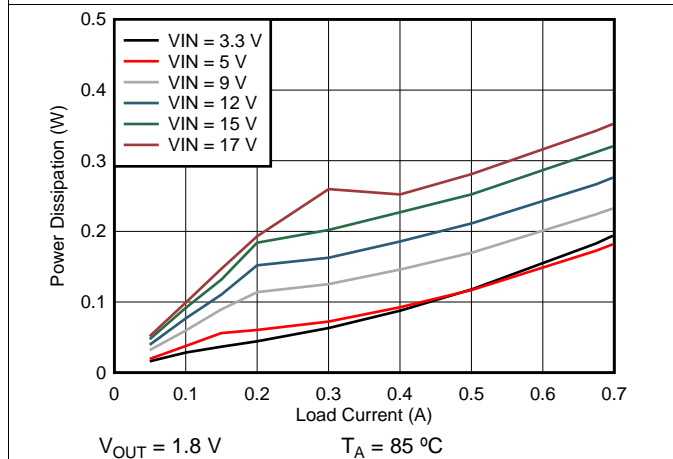

Figure 5. Power Dissipation

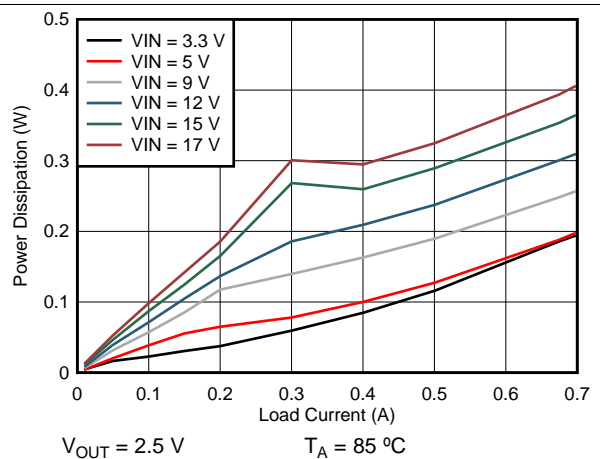
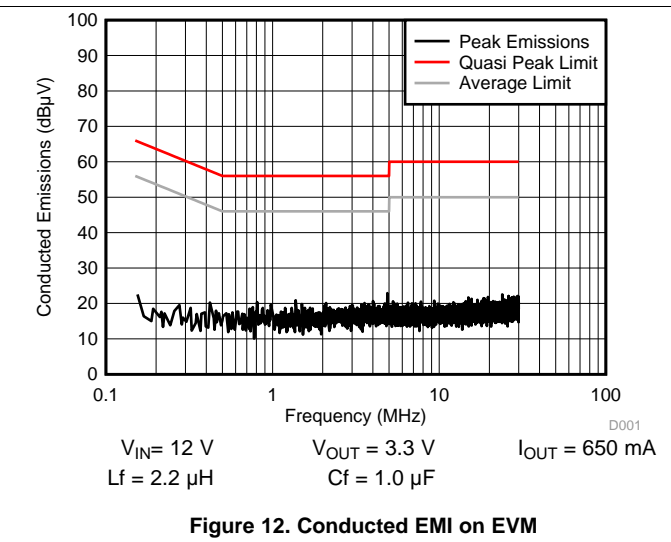
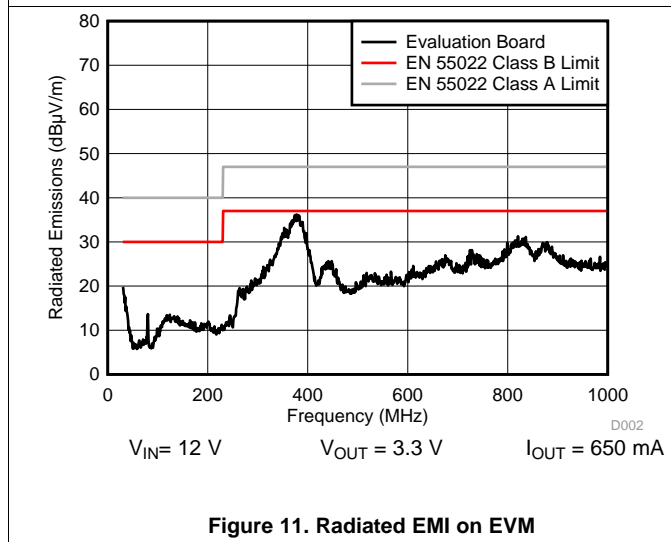
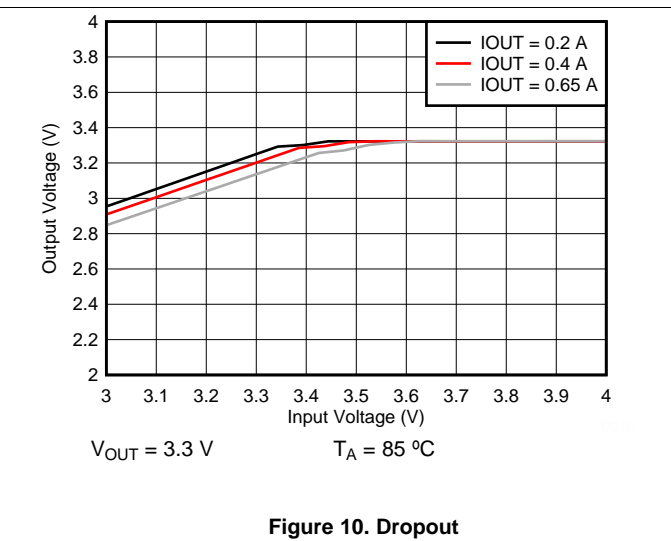
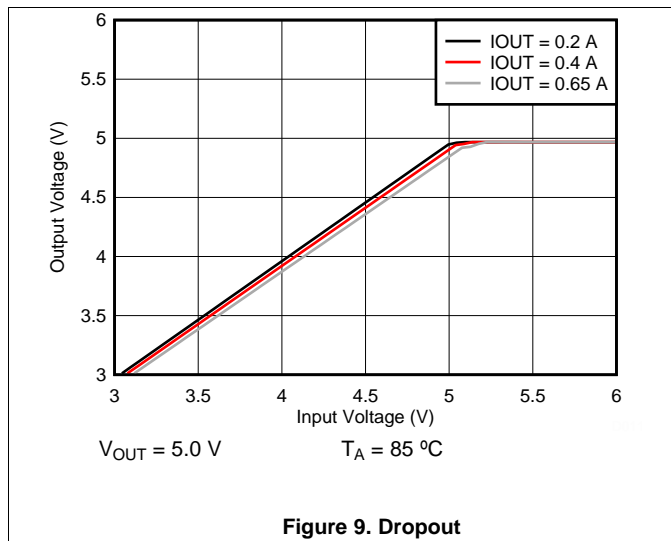
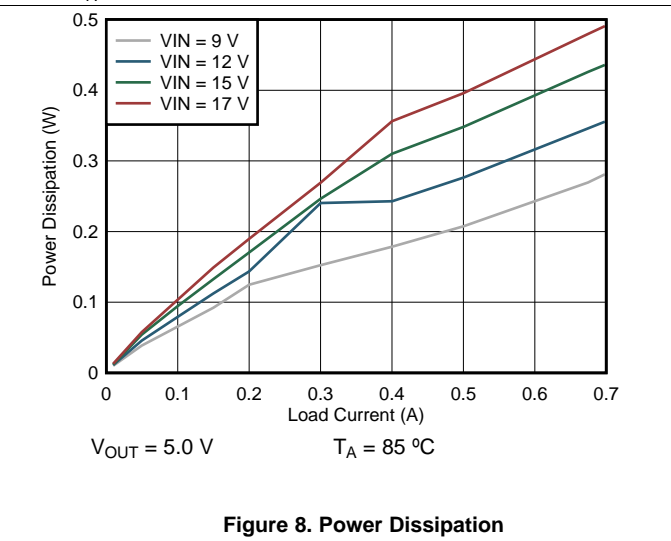
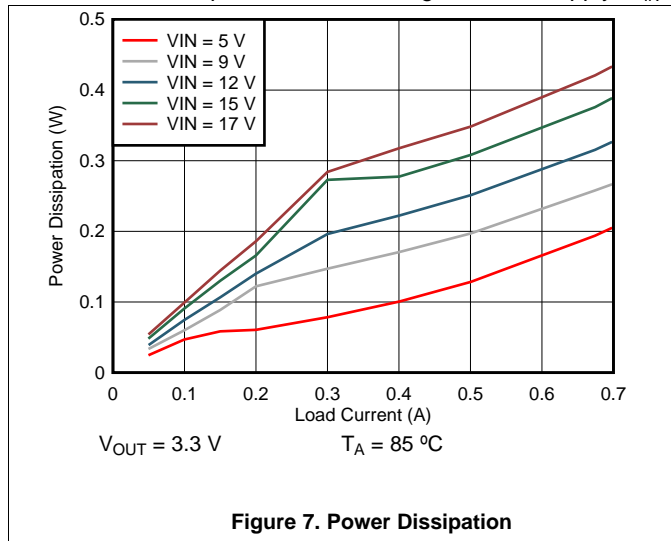

Figure 6. Power Dissipation

Typical Characteristics (continued)

Unless otherwise specified the following conditions apply:  $V_{IN} = 12\text{ V}$ ,  $T_A = 25\text{ }^\circ\text{C}$



## 8 Detailed Description

### 8.1 Overview

The LMZ21700 SIMPLE SWITCHER® Nano Module is an easy-to-use step-down DC-DC solution capable of driving up to 650 mA load in space-constrained applications. Only an input capacitor, an output capacitor, a softstart capacitor, and two resistors are required for basic operation. The Nano Module comes in 8-pin DFN footprint package with an integrated inductor. The LMZ21700 architecture is based on DCS-Control™ (Direct Control with Seamless Transition into Power Save Mode). This architecture combines the fast transient response and stability of hysteretic type converters along with the accurate DC output regulation of voltage mode and current mode regulators.

The LMZ21700 architecture uses Pulse Width Modulation (PWM) mode for medium and heavy load requirements and Power Save Mode (PSM) at light loads for high efficiency. In PWM mode the switching frequency is controlled over the input voltage range. The value depends on the output voltage setting and is typically reduced at low output voltages to achieve higher efficiency. In PSM the switching frequency decreases linearly with the load current. Since the architecture of the device supports both operation modes (PWM and PSM) in a single circuit building block, the transition between the modes of operation is seamless with minimal effect on the output voltage.

### 8.2 Functional Block Diagram

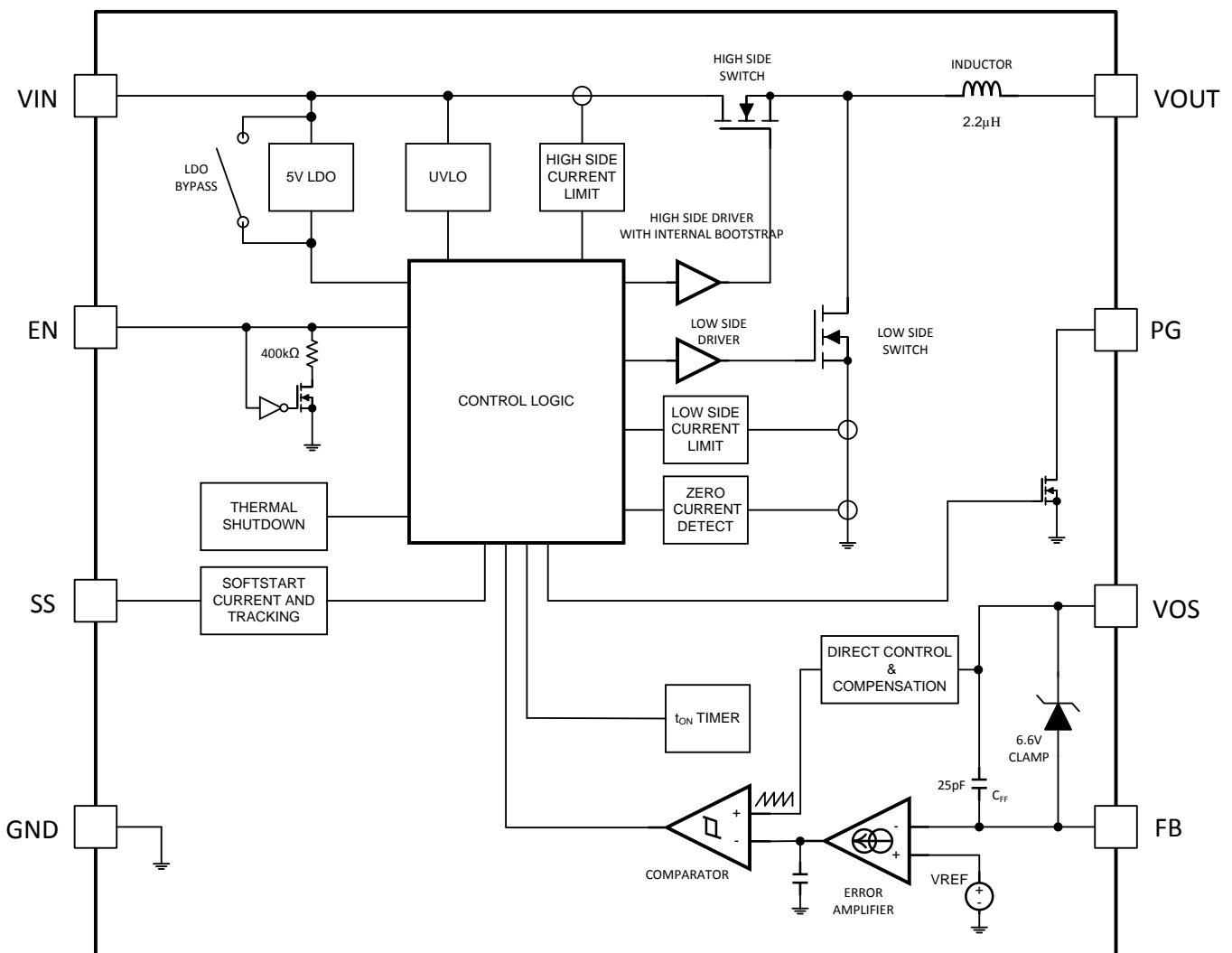

### 8.3 Package Construction

In order to achieve a small solution size the LMZ21700 Nano Module comes in an innovative MicroSiP™ package. The construction consists of a synchronous buck converter IC embedded inside an FR-4 laminate substrate, with a power inductor mounted on top of the substrate material. See [Figure 13](#) and [Figure 14](#) below. The bottom (landing pads) of the package resemble a typical 8-pin DFN package. See the Mechanical drawings at the end of the datasheet for details on the recommended landing pattern and solder paste stencil information.

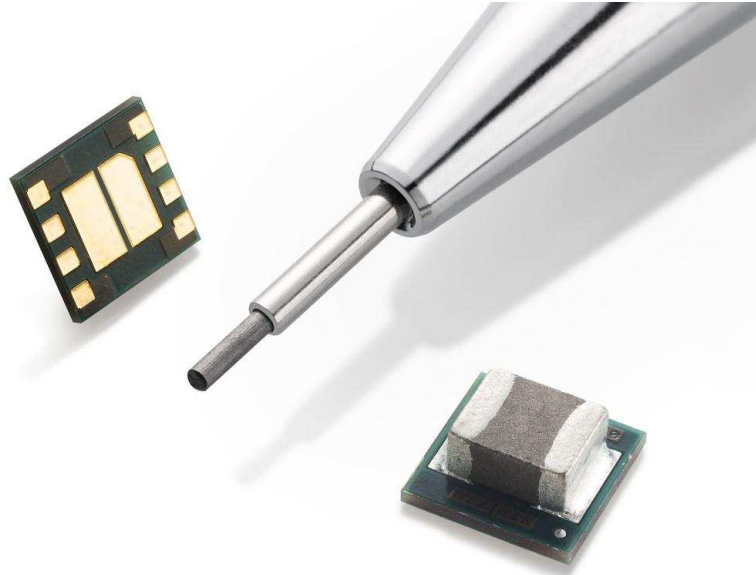

Figure 13. LMZ21700 in the SIL0008E Package

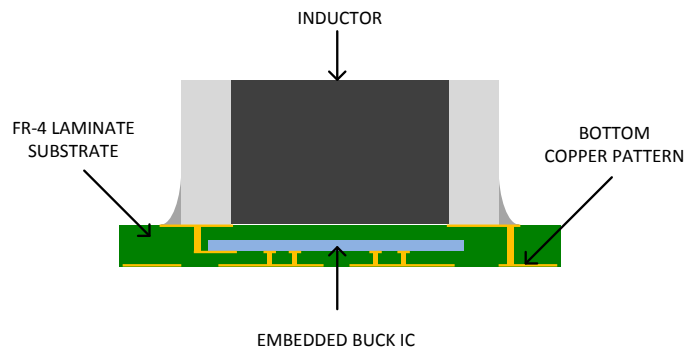

Figure 14. LMZ21700 Package Construction Cross Section (Illustration Only, Not to Scale)

### 8.4 Feature Description

#### 8.4.1 Input Under Voltage Lockout

The LMZ21700 features input under voltage lockout (UVLO) circuit. It monitors the input voltage level and prevents the device from switching the power MOSFETs if  $V_{IN}$  is not high enough. The typical  $V_{IN}$  UVLO rising threshold is 2.9 V with 180 mV of hysteresis.

## Feature Description (continued)

### 8.4.2 Enable Input (EN)

The enable pin (EN) is weakly pulled down internally through a 400 kΩ resistor to keep EN logic low when the pin is floating. The pull-down resistor is not connected when EN is set high. Once the voltage on the enable pin (EN) is set high the Nano Module will start operation. If EN is set low ( < 0.3 V ) the LMZ21700 will enter shutdown mode. The typical shutdown quiescent current is 1.5 μA.

### 8.4.3 Softstart and Tracking Function (SS)

When EN is set high for device operation the LMZ21700 will start switching after 50 μs delay and the output voltage will start rising. The  $V_{OUT}$  rising slope is controlled by the external capacitor  $C_{SS}$  connected to the softstart (SS) pin. The nano module has a 2.5 μA constant current source internally connected to the SS pin to program the softstart time  $T_{SS}$ :

$$T_{SS} = C_{SS} \times 1.25 \text{ V} / 2.5 \text{ } \mu\text{A} \quad (1)$$

The softstart capacitor voltage is reset to zero volts when EN is pulled low and when the thermal protection is active.

If tracking function is desired, the SS pin can be used to track external voltage. If the applied external tracking voltage is between 100 mV and 1.2 V, the FB voltage will follow SS according to the following relationship:

$$V_{FB} = 0.64 \times V_{SS} \quad (2)$$

### 8.4.4 Power Good Function (PG)

The LMZ21700 features a Power Good (PG) function which can be used for sequencing of multiple rails. The PG pin is an open-drain output and requires a pull-up resistor  $R_{PG}$  to  $V_{OUT}$  (or any other external voltage less than 7 V). When the Nano Module is enabled and UVLO is satisfied, the power good function starts monitoring the output voltage. The PG pin is kept at logic low if the output has not reached the proper regulation voltage. Refer to the [Electrical Characteristics](#) table for the PG voltage thresholds. The PG pin can sink 2 mA of current which sets the minimum limit of the  $R_{PG}$  resistance value:

$$R_{PG-MIN} = V_{PULL-UP} / 2 \text{ mA} \quad (3)$$

The PG pin goes low impedance if the device is disabled or the thermal protection is active.

### 8.4.5 Output Voltage Setting

The output voltage of the LMZ21700 is set by a resistive divider from  $V_{OUT}$  to GND, connected to the feedback (FB) pin. The output voltage can be set between 0.9 V and 6 V. The voltage at the FB pin is regulated to 0.8 V. The recommended minimum divider current is 2 μA. This sets a maximum limit on the bottom feedback resistor  $R_{FBB}$ . Its value should not exceed 400 kΩ. The top feedback resistor  $R_{FBT}$  can be calculated using the following formula:

$$R_{FBT} = R_{FBB} \times (V_{OUT} / 0.8 - 1) \quad (4)$$

### 8.4.6 Output Current Limit and Output Short Circuit Protection

The LMZ21700 has integrated protection against heavy loads and output short circuit events. Both, the high-side FET and low-side FET have current monitoring circuitry. If the current limit threshold of the high-side FET is reached, the high-side FET will be turned off and the low-side FET will be turned on to ramp down the inductor current. Once the current through the low-side FET has decreased below a safe level, the high-side device will be allowed to turn on again. The actual DC output current depends on the input voltage, output voltage, and switching frequency. Refer to the [Application Curves](#) section for more information.

### 8.4.7 Thermal Protection

The nano module monitors its junction temperature ( $T_j$ ) and shuts itself off if the it gets too hot. The thermal shutdown threshold for the junction is typically 160 °C. Both, high-side and low-side FETs are turned off until the junction temperature has decreased under the hysteresis level, typically 30 °C below the shutdown temperature.

## 8.5 Device Functional Modes

### 8.5.1 PWM Mode Operation

The LMZ21700 operates in PWM mode when the output current is greater than half the inductor ripple current. The frequency variation in PWM mode is controlled and depends on the  $V_{IN}$  and  $V_{OUT}$  settings. Refer to the [Application Curves](#) section for switching frequency graphs for several typical output voltage settings. As the load current is decreased and the valley of the inductor current ripple reaches 0 A the device enters PSM operation to maintain high efficiency.

### 8.5.2 PSM Operation

Once the load current decreases and the valley of the inductor current reaches 0 A, the LMZ21700 will transition to Power Save Mode of operation. The device will remain in PSM as long as the inductor current is discontinuous. The switching frequency will decrease linearly with the load current. If  $V_{IN}$  decreases to about 15 % above  $V_{OUT}$  the device will not enter PSM and will maintain output regulation in PWM mode.

## 9 Application and Implementation

### NOTE

Information in the following applications sections is not part of the TI component specification, and TI does not warrant its accuracy or completeness. TI's customers are responsible for determining suitability of components for their purposes. Customers should validate and test their design implementation to confirm system functionality.

### 9.1 Application Information

The LMZ21700 is a step down DC-to-DC converter. It is used to convert higher DC voltage to a regulated lower DC voltage with maximum load current of 650 mA. The following design procedure can be used to select components for the LMZ21700. Alternatively, the WEBENCH<sup>®</sup> software can be used to select from a large database of components, run electrical simulations, and optimize the design for specific performance. Please go to [webench.ti.com](http://webench.ti.com) to access the WEBENCH<sup>®</sup> tool.

### 9.2 Typical Application

For a quick start, the following component values can be used as a design starting point for several typical output voltage rails and 650 mA of output load current.

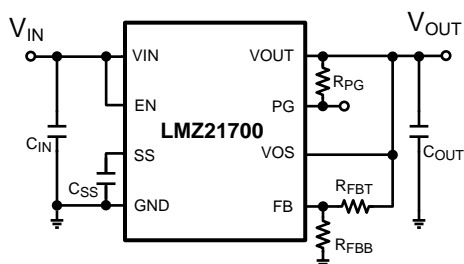

Figure 15. Typical Applications Circuit

COMPONENT VALUES FOR V <sub>OUT</sub> =1.2V			
C <sub>IN</sub>	22μF	≥ 25V	X7R or X5R
C <sub>OUT</sub>	22μF	≥ 10V	X7R or X5R
C <sub>SS</sub>	3300pF	≥ 10V	X7R or X5R
R <sub>FBT</sub>	41.2kΩ	1%	
R <sub>FBB</sub>	82.5kΩ	1%	
R <sub>PG</sub>	10kΩ	1%	

Figure 16. External Component Values  
( V<sub>OUT</sub> = 1.2 V )

**Typical Application (continued)**

COMPONENT VALUES FOR $V_{OUT}=1.8V$			
$C_{IN}$	22 $\mu$ F	$\geq 25V$	X7R or X5R
$C_{OUT}$	22 $\mu$ F	$\geq 10V$	X7R or X5R
$C_{SS}$	3300pF	$\geq 10V$	X7R or X5R
$R_{FBT}$	147k $\Omega$	1%	
$R_{FBB}$	118k $\Omega$	1%	
$R_{PG}$	10k $\Omega$	1%	

**Figure 17. External Component Values  
( $V_{OUT} = 1.8 V$ )**

COMPONENT VALUES FOR $V_{OUT}=2.5V$			
$C_{IN}$	22 $\mu$ F	$\geq 25V$	X7R or X5R
$C_{OUT}$	22 $\mu$ F	$\geq 10V$	X7R or X5R
$C_{SS}$	3300pF	$\geq 10V$	X7R or X5R
$R_{FBT}$	357k $\Omega$	1%	
$R_{FBB}$	169k $\Omega$	1%	
$R_{PG}$	10k $\Omega$	1%	

**Figure 18. External Component Values  
( $V_{OUT} = 2.5 V$ )**

COMPONENT VALUES FOR $V_{OUT}=3.3V$			
$C_{IN}$	22 $\mu$ F	$\geq 25V$	X7R or X5R
$C_{OUT}$	22 $\mu$ F	$\geq 10V$	X7R or X5R
$C_{SS}$	3300pF	$\geq 10V$	X7R or X5R
$R_{FBT}$	1.21M $\Omega$	1%	
$R_{FBB}$	383k $\Omega$	1%	
$R_{PG}$	10k $\Omega$	1%	

**Figure 19. External Component Values  
( $V_{OUT} = 3.3 V$ )**

COMPONENT VALUES FOR $V_{OUT}=5.0V$			
$C_{IN}$	22 $\mu$ F	$\geq 25V$	X7R or X5R
$C_{OUT}$	22 $\mu$ F	$\geq 10V$	X7R or X5R
$C_{SS}$	3300pF	$\geq 10V$	X7R or X5R
$R_{FBT}$	232k $\Omega$	1%	
$R_{FBB}$	44.2k $\Omega$	1%	
$R_{PG}$	10k $\Omega$	1%	

**Figure 20. External Component Values  
( $V_{OUT} = 5.0 V$ )**
**9.2.1 Design Requirements**

The design procedure requires a few typical design parameters. See [Table 3](#) below.

**Table 3. Design Parameters**

Design Parameter	Value
Input Voltage ( $V_{IN}$ )	Range from 3.0 V to 17 V
Output Voltage ( $V_{OUT}$ )	Range from 0.9 V to 6 V
Output Current ( $I_{OUT}$ )	Up to 650 mA
Softstart time ( $T_{SS}$ )	Minimum of 0.5 ms recommended

**9.2.2 Detailed Design Procedure**
**9.2.2.1 Input Capacitor ( $C_{IN}$ )**

Low ESR multi-layer ceramic capacitors (MLCC) are recommended for the input capacitor of the LMZ21700. Using a  $\geq 10 \mu\text{F}$  ceramic input capacitor in  $\geq 0805$  (2012 metric) case size with 25 V rating typically provides sufficient  $V_{IN}$  bypass. Use of multiple capacitors can also be considered. Ceramic capacitors with X5R and X7R temperature characteristics are recommended. These provide an optimal balance between small size, cost, reliability, and performance for applications with limited space. The DC voltage bias characteristics of the capacitors must be considered when selecting the DC voltage rating and case size of these components. The effective capacitance of an MLCC is typically reduced by the DC voltage bias applied across its terminals. Selecting a part with larger capacitance, larger case size, or higher voltage rating can compensate for the capacitance loss due to the DC voltage bias effect. For example, a 10  $\mu\text{F}$ , X7R, 25 V rated capacitor used under 12 V DC bias may have approximately 8  $\mu\text{F}$  effective capacitance in a 1210 (3225 metric) case size and about 6  $\mu\text{F}$  in a 1206 (3216 metric) case size. As another example, a 10  $\mu\text{F}$ , X7R, 16 V rated capacitor in a 1210 (3225 metric) case size used at 12 V DC bias may have approximately 5.5  $\mu\text{F}$  effective capacitance. Check the capacitor specifications published by the manufacturer.

### 9.2.2.2 Output Capacitor ( $C_{OUT}$ )

Similarly to the input capacitor, it is recommended to use low ESR multi-layer ceramic capacitors for  $C_{OUT}$ . Ceramic capacitors with X5R and X7R temperature characteristics are recommended. Use 10  $\mu\text{F}$  or larger value and consider the DC voltage bias characteristics of the capacitor when choosing the case size and voltage rating. For stability, the output capacitor should be in the 10  $\mu\text{F}$  – 200  $\mu\text{F}$  effective capacitance range.

### 9.2.2.3 Softstart Capacitor ( $C_{SS}$ )

The softstart capacitor is chosen according to the desired softstart time. As described in the [Softstart and Tracking Function](#) section the softstart time  $T_{SS} = C_{SS} \times 1.25 \text{ V} / 2.5 \mu\text{A}$ .

A minimum  $C_{SS}$  value of 1000 pF is required for monotonic  $V_{OUT}$  ramp up.

### 9.2.2.4 Power Good Resistor ( $R_{PG}$ )

If the Power Good function is used, a pull up resistor  $R_{PG}$  is necessary from the PG pin to an external pull-up voltage.

The minimum  $R_{PG}$  value is restricted by the pull down current capability of the internal pull down device.

$$R_{PG-MIN} = V_{PULL-UP} / 2 \text{ mA} \quad (5)$$

The maximum  $R_{PG}$  value is based on the maximum PG leakage current and the minimum “logic high” level system requirements:

$$R_{PG-MAX} = (V_{PULL-UP} - V_{LOGIC-HIGH}) / I_{LKG\_PG} \quad (6)$$

### 9.2.2.5 Feedback Resistors ( $R_{FBB}$ and $R_{FBT}$ )

The feedback resistors  $R_{FBB}$  and  $R_{FBT}$  set the desired output voltage. Choose  $R_{FBB}$  less than 400 k $\Omega$  and calculate the value for  $R_{FBT}$  using the following formula:

$$R_{FBT} = R_{FBB} \times (V_{OUT} / 0.8 - 1) \quad (7)$$



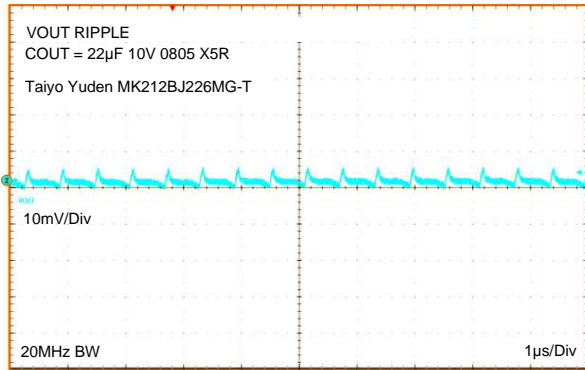

Figure 27. 20MHz Oscilloscope Bandwidth Output Voltage Ripple  $V_{OUT} = 1.2V$

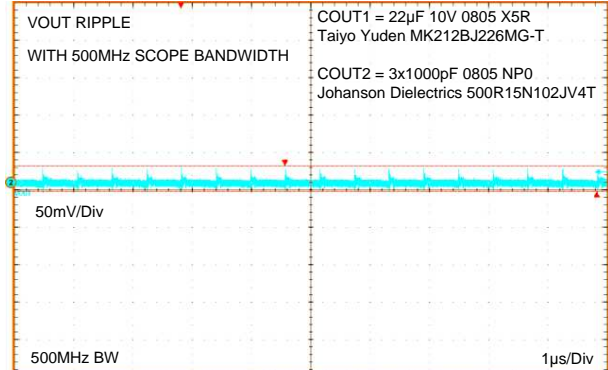

Figure 28. 500MHz Oscilloscope Bandwidth, 3x1000pF additional output capacitance Output Voltage Ripple and HF Noise  $V_{OUT} = 1.2V$

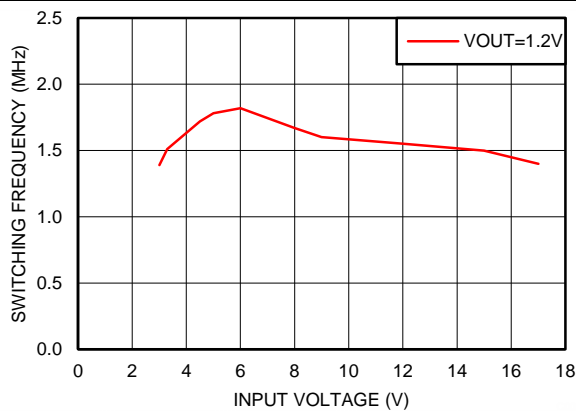

Figure 29. Typical Switching Frequency at 650mA Load  $V_{OUT} = 1.2V$

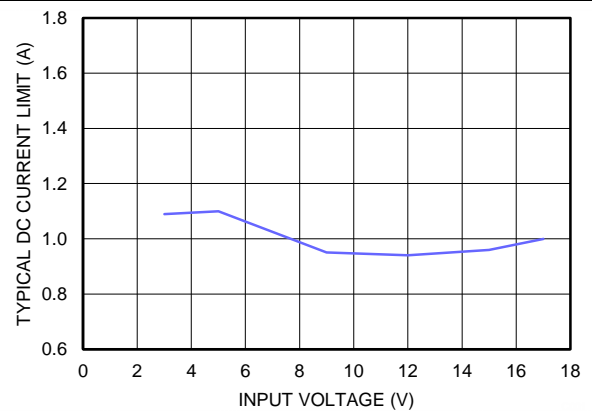

Figure 30. Typical Current Limit  $V_{OUT} = 1.2V$ ,  $T_A = 85^\circ C$

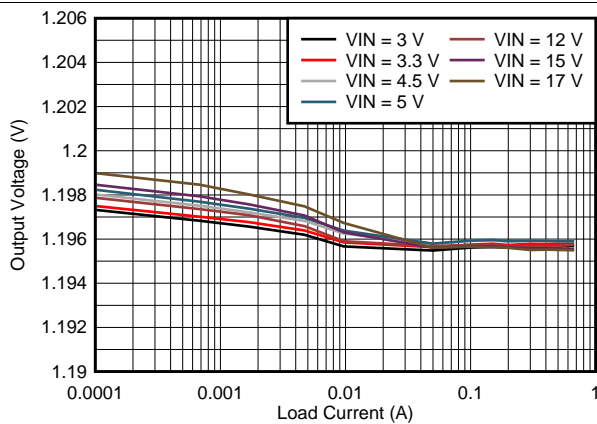

Figure 31. Line and Load Regulation  $V_{OUT} = 1.2V$

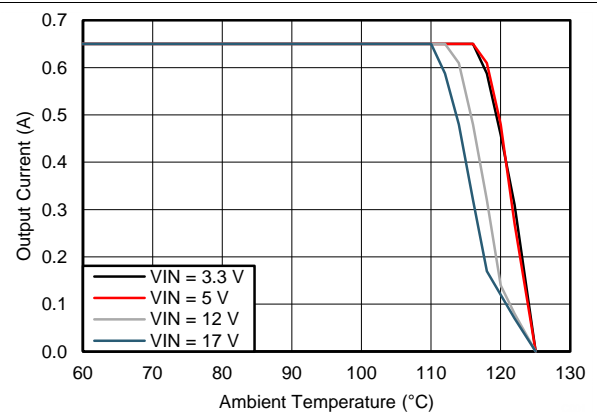

Figure 32. Thermal Derating for  $\theta_{JA} = 47^\circ C/W$ ,  $V_{OUT} = 1.2V$

# LMZ21700

SNVS872C – AUGUST 2012 – REVISED NOVEMBER 2014

www.ti.com

## 9.2.3.2 $V_{OUT} = 1.8\text{ V}$

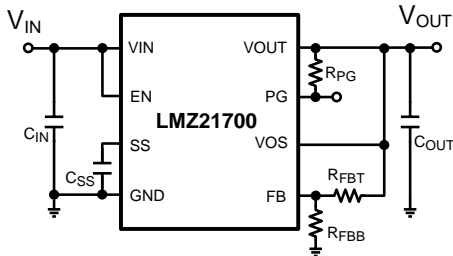

Figure 33. Typical Applications Circuit

COMPONENT VALUES FOR $V_{OUT}=1.8\text{V}$			
$C_{IN}$	22 $\mu\text{F}$	$\geq 25\text{V}$	X7R or X5R
$C_{OUT}$	22 $\mu\text{F}$	$\geq 10\text{V}$	X7R or X5R
$C_{SS}$	3300pF	$\geq 10\text{V}$	X7R or X5R
$R_{FBT}$	147k $\Omega$	1%	
$R_{FBB}$	118k $\Omega$	1%	
$R_{PG}$	10k $\Omega$	1%	

Figure 34. External Component Values ( $V_{OUT} = 1.8\text{V}$ )

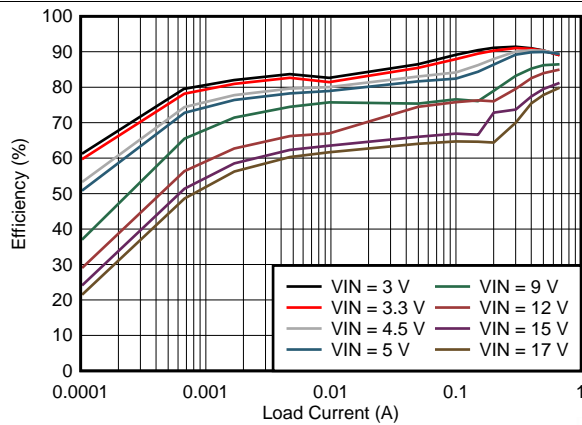

Figure 35. Efficiency  $V_{OUT} = 1.8\text{ V}$

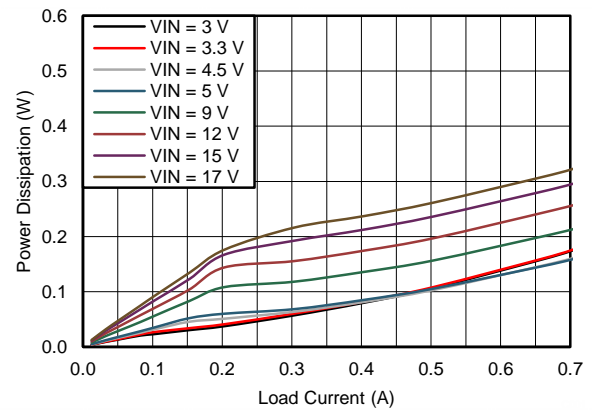

Figure 36. Power Dissipation  $V_{OUT} = 1.8\text{ V}$

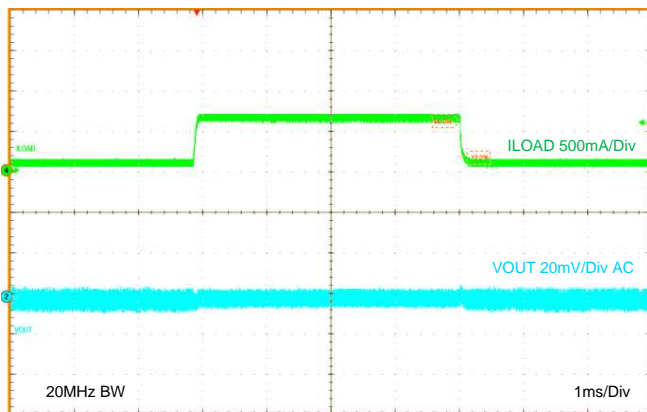

Figure 37. Load Transient  $V_{OUT} = 1.8\text{ V}$

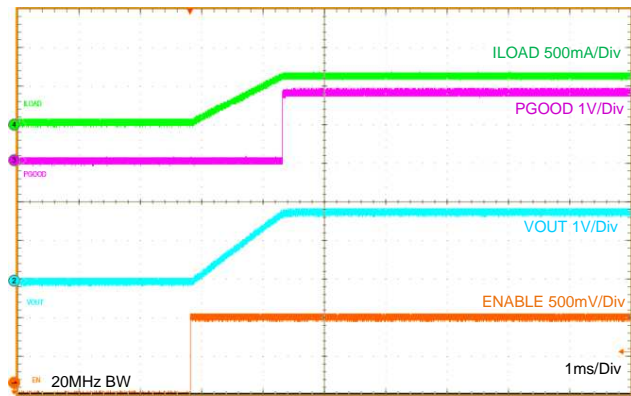

Figure 38. Startup  $V_{OUT} = 1.8\text{ V}$

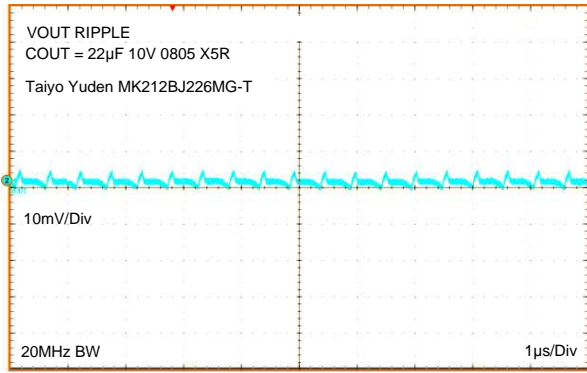

Figure 39. 20MHz Oscilloscope Bandwidth Output Voltage Ripple  $V_{OUT} = 1.8\text{ V}$

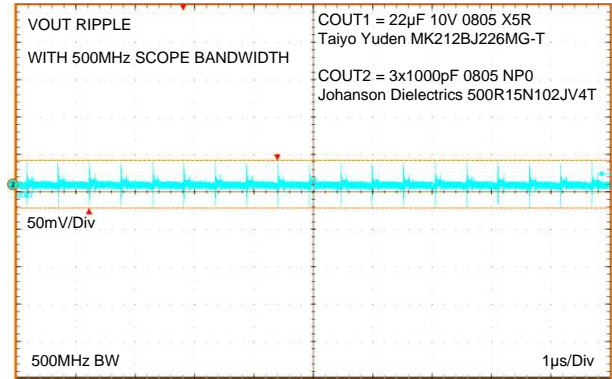

Figure 40. 500MHz Oscilloscope Bandwidth, 3x1000pF additional output capacitance Output Voltage Ripple and HF Noise  $V_{OUT} = 1.8\text{ V}$

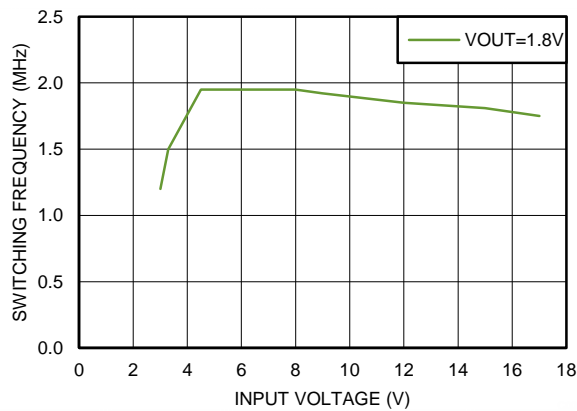

Figure 41. Typical Switching Frequency at 650mA Load  $V_{OUT} = 1.8\text{ V}$

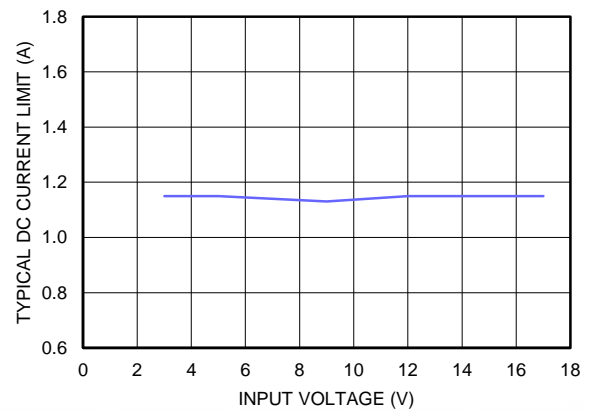

Figure 42. Typical Current Limit  $V_{OUT} = 1.8\text{ V}$ ,  $T_A = 85\text{ }^\circ\text{C}$

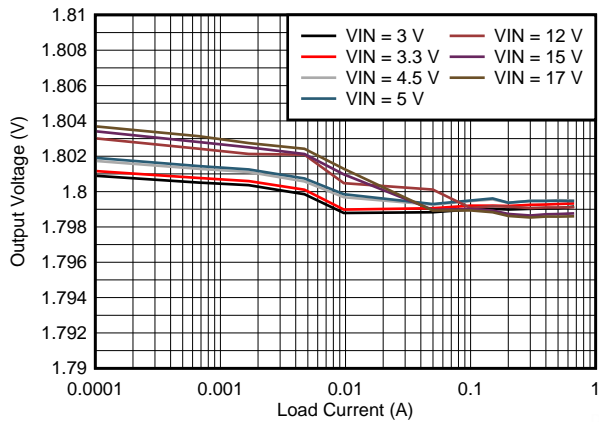

Figure 43. Line and Load Regulation  $V_{OUT} = 1.8\text{ V}$

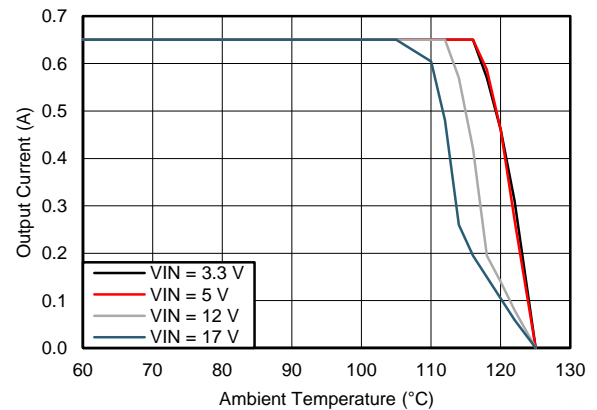

Figure 44. Thermal Derating for  $\theta_{JA}=47^\circ\text{C/W}$ ,  $V_{OUT} = 1.8\text{ V}$

# LMZ21700

SNVS872C – AUGUST 2012 – REVISED NOVEMBER 2014

www.ti.com

## 9.2.3.3 $V_{OUT} = 2.5\text{ V}$

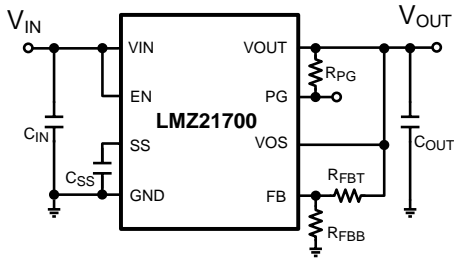

Figure 45. Typical Applications Circuit

COMPONENT VALUES FOR $V_{OUT}=2.5\text{ V}$			
$C_{IN}$	22 $\mu\text{F}$	$\geq 25\text{ V}$	X7R or X5R
$C_{OUT}$	22 $\mu\text{F}$	$\geq 10\text{ V}$	X7R or X5R
$C_{SS}$	3300pF	$\geq 10\text{ V}$	X7R or X5R
$R_{FBT}$	357k $\Omega$	1%	
$R_{FBB}$	169k $\Omega$	1%	
$R_{PG}$	10k $\Omega$	1%	

Figure 46. External Component Values ( $V_{OUT} = 2.5\text{ V}$ )

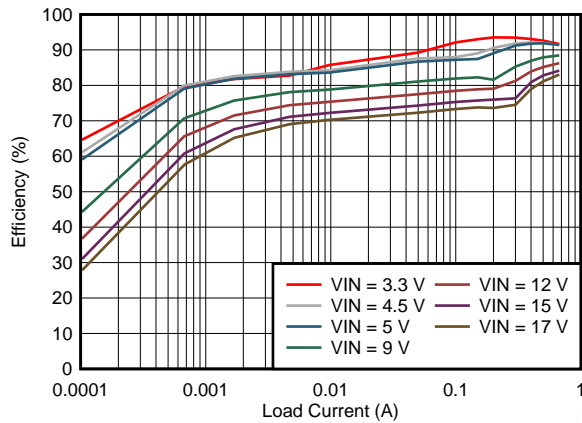

Figure 47. Efficiency  $V_{OUT} = 2.5\text{ V}$

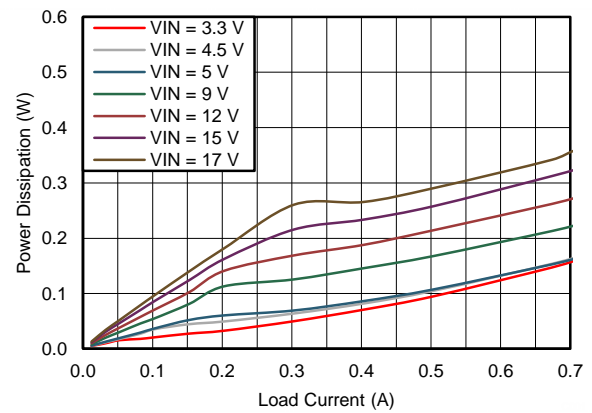

Figure 48. Power Dissipation  $V_{OUT} = 2.5\text{ V}$

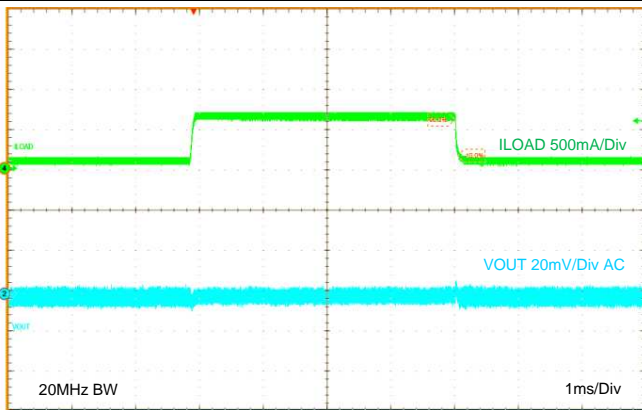

Figure 49. Load Transient  $V_{OUT} = 2.5\text{ V}$

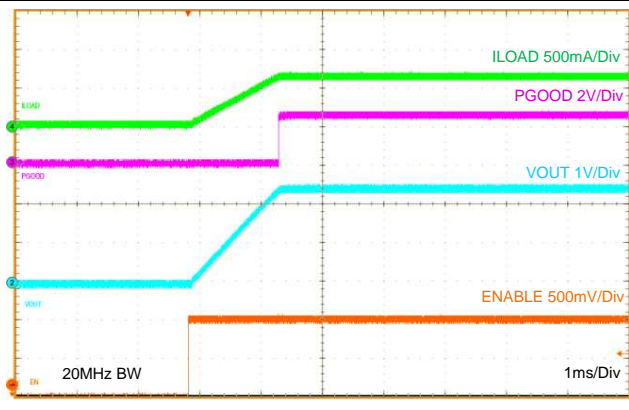

Figure 50. Startup  $V_{OUT} = 2.5\text{ V}$

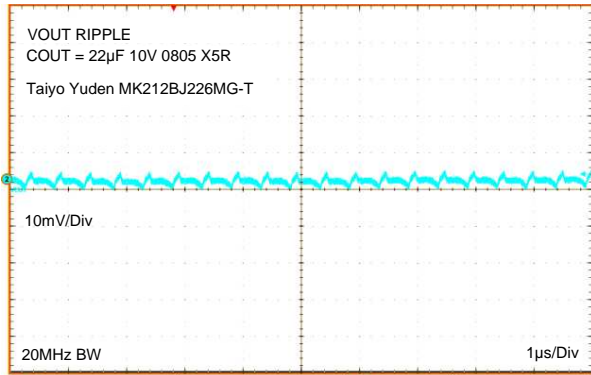

Figure 51. 20MHz Oscilloscope Bandwidth Output Voltage Ripple  $V_{OUT} = 2.5\text{ V}$

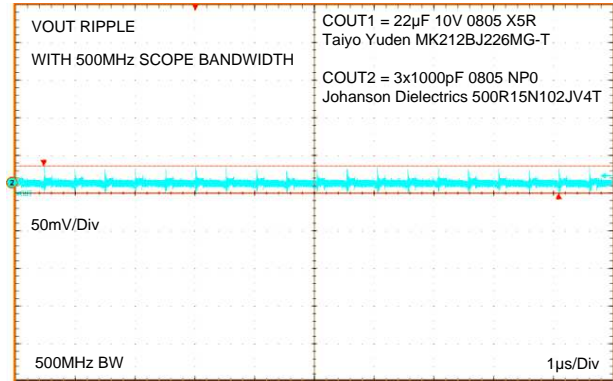

Figure 52. 500MHz Oscilloscope Bandwidth, 3x1000pF additional output capacitance Output Voltage Ripple and HF Noise  $V_{OUT} = 2.5\text{ V}$

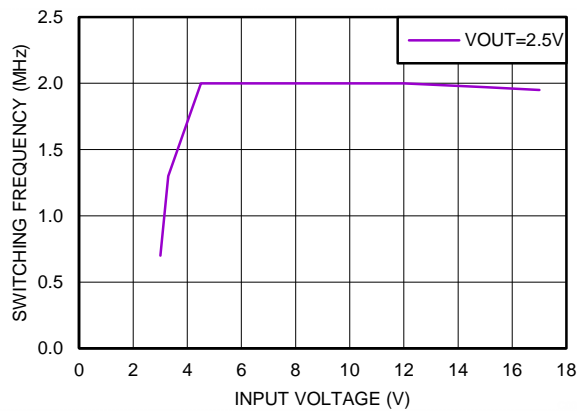

Figure 53. Typical Switching Frequency at 650mA Load  $V_{OUT} = 2.5\text{ V}$

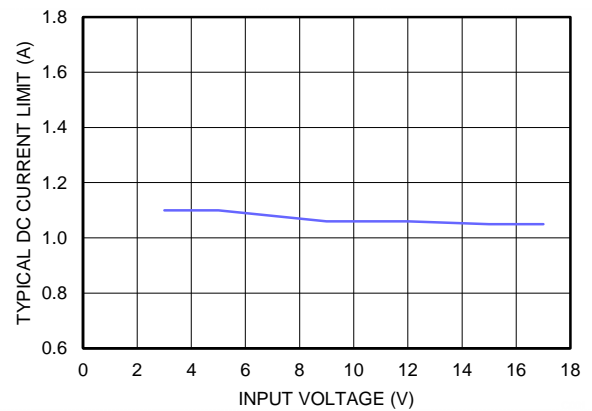

Figure 54. Typical Current Limit  $V_{OUT} = 2.5\text{ V}$ ,  $T_A = 85\text{ }^\circ\text{C}$

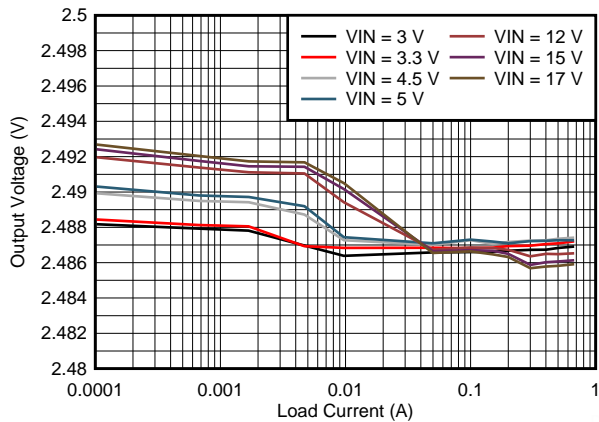

Figure 55. Line and Load Regulation  $V_{OUT} = 2.5\text{ V}$

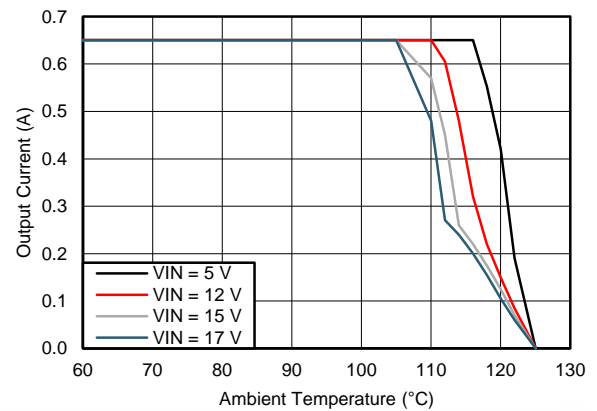

Figure 56. Thermal Derating for  $\theta_{JA}=47^\circ\text{C/W}$ ,  $V_{OUT} = 2.5\text{ V}$

# LMZ21700

SNVS872C – AUGUST 2012 – REVISED NOVEMBER 2014

www.ti.com

## 9.2.3.4 $V_{OUT} = 3.3\text{ V}$

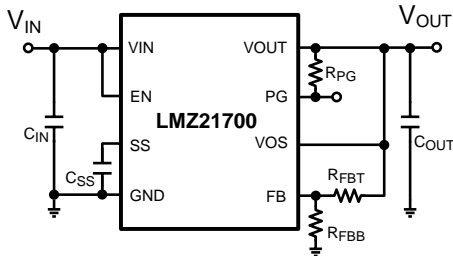

Figure 57. Typical Applications Circuit

COMPONENT VALUES FOR $V_{OUT}=3.3\text{V}$			
$C_{IN}$	22 $\mu\text{F}$	$\geq 25\text{V}$	X7R or X5R
$C_{OUT}$	22 $\mu\text{F}$	$\geq 10\text{V}$	X7R or X5R
$C_{SS}$	3300pF	$\geq 10\text{V}$	X7R or X5R
$R_{FBT}$	1.21M $\Omega$	1%	
$R_{FBB}$	383k $\Omega$	1%	
$R_{PG}$	10k $\Omega$	1%	

Figure 58. External Component Values ( $V_{OUT} = 3.3\text{V}$ )

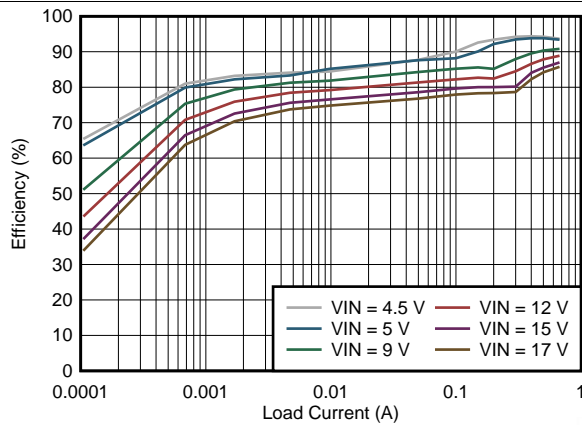

Figure 59. Efficiency  $V_{OUT} = 3.3\text{ V}$

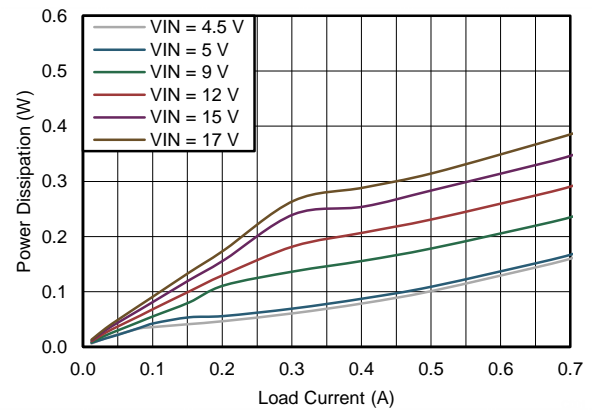

Figure 60. Power Dissipation  $V_{OUT} = 3.3\text{ V}$

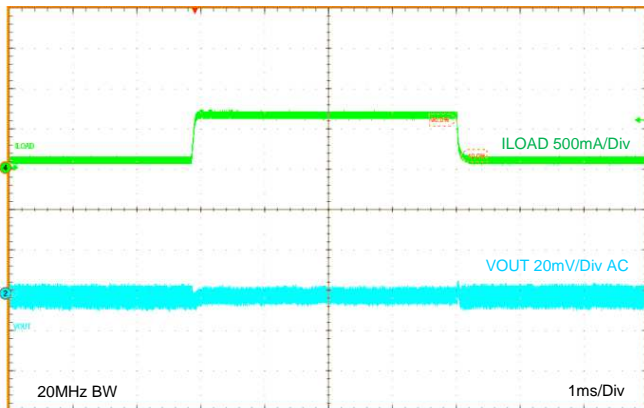

Figure 61. Load Transient  $V_{OUT} = 3.3\text{ V}$

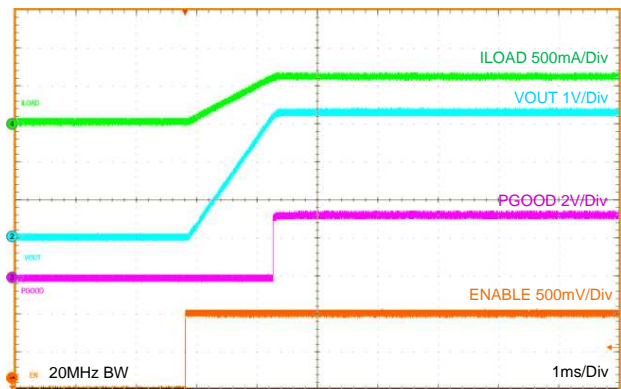

Figure 62. Startup  $V_{OUT} = 3.3\text{ V}$

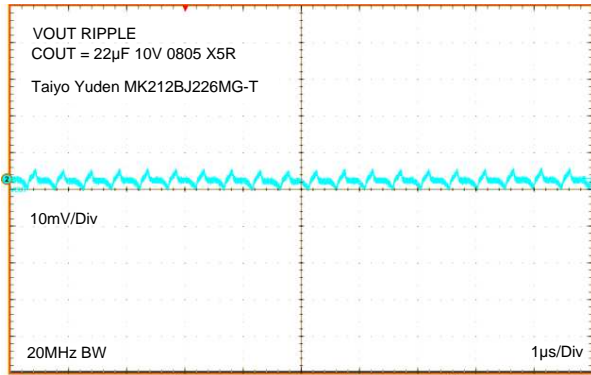

Figure 63. 20 MHz Oscilloscope Bandwidth Output Voltage Ripple  $V_{OUT} = 3.3\text{ V}$

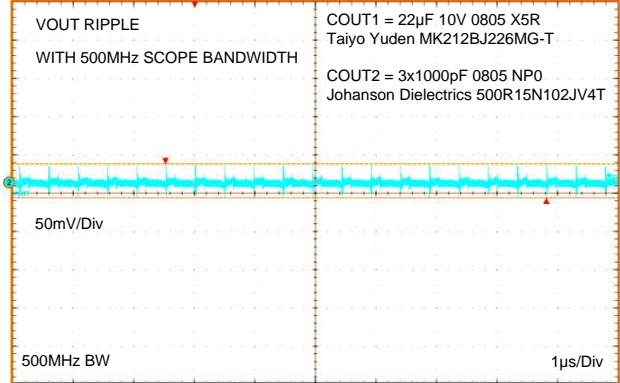

Figure 64. 500MHz Oscilloscope Bandwidth, 3x1000 pF additional output capacitance Output Voltage Ripple and HF Noise  $V_{OUT} = 3.3\text{ V}$

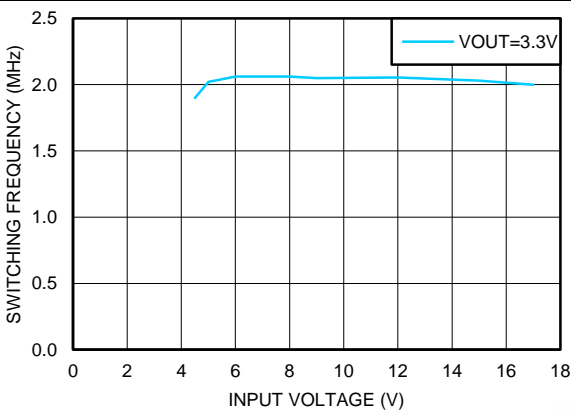

Figure 65. Typical Switching Frequency at 650mA Load  $V_{OUT} = 3.3\text{ V}$

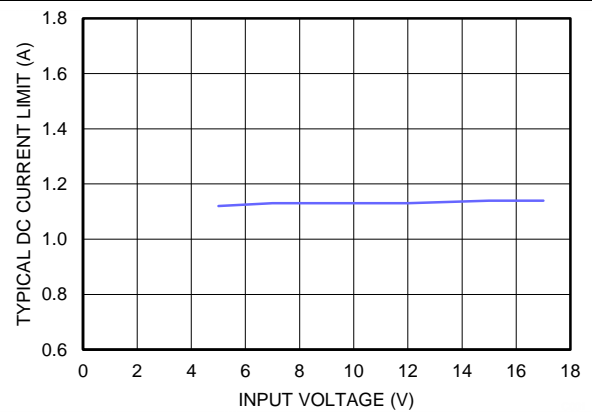

Figure 66. Typical Current Limit  $V_{OUT} = 3.3\text{ V}$ ,  $T_A = 85^\circ\text{C}$

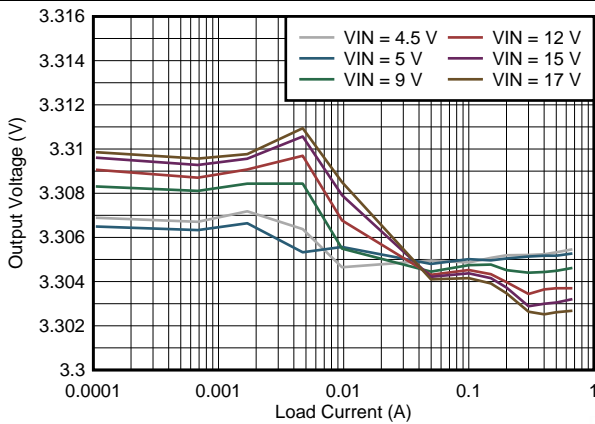

Figure 67. Line and Load Regulation  $V_{OUT} = 3.3\text{ V}$

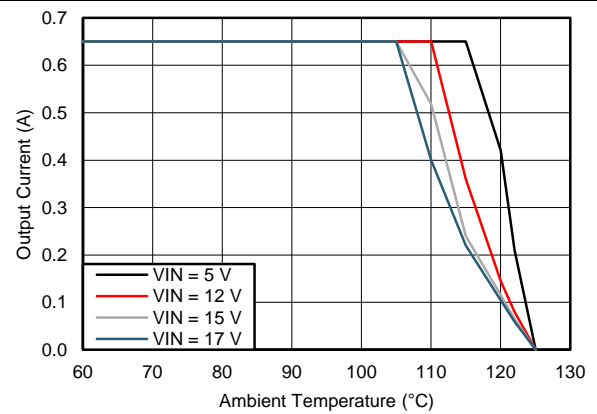

Figure 68. Thermal Derating for  $\theta_{JA} = 47^\circ\text{C/W}$ ,  $V_{OUT} = 3.3\text{ V}$

# LMZ21700

SNVS872C – AUGUST 2012 – REVISED NOVEMBER 2014

www.ti.com

## 9.2.3.5 $V_{OUT} = 5.0\text{ V}$

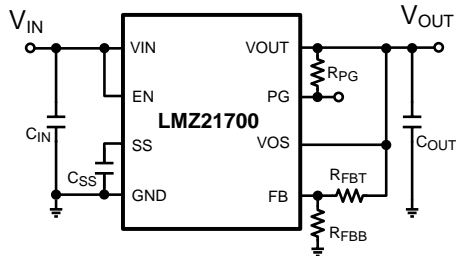

Figure 69. Typical Applications Circuit

COMPONENT VALUES FOR $V_{OUT}=5.0\text{V}$			
$C_{IN}$	22 $\mu\text{F}$	$\geq 25\text{V}$	X7R or X5R
$C_{OUT}$	22 $\mu\text{F}$	$\geq 10\text{V}$	X7R or X5R
$C_{SS}$	3300pF	$\geq 10\text{V}$	X7R or X5R
$R_{FBT}$	232k $\Omega$	1%	
$R_{FBB}$	44.2k $\Omega$	1%	
$R_{PG}$	10k $\Omega$	1%	

Figure 70. External Component Values ( $V_{OUT} = 5.0\text{V}$ )

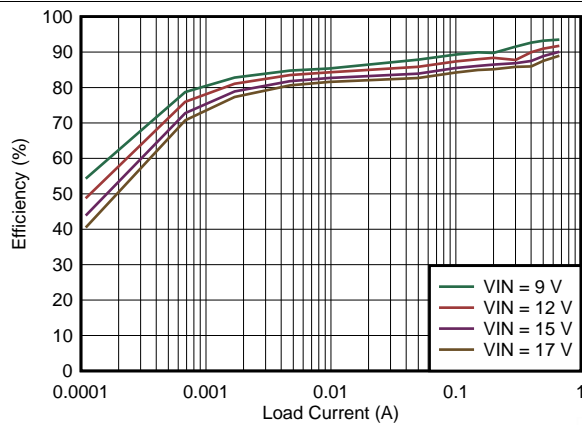

Figure 71. Efficiency  $V_{OUT} = 5.0\text{ V}$

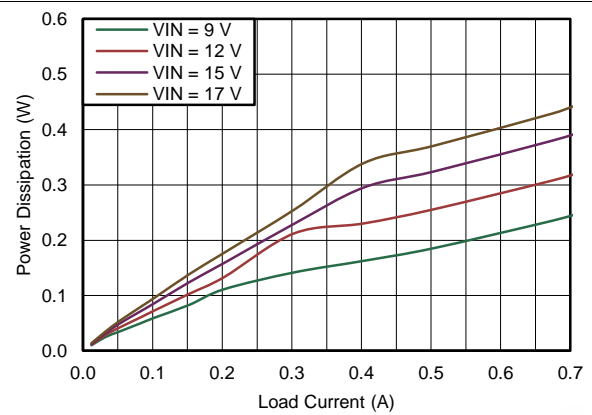

Figure 72. Power Dissipation  $V_{OUT} = 5.0\text{ V}$

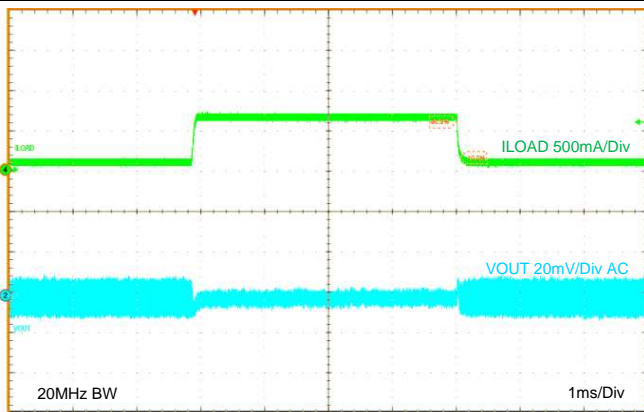

Figure 73. Load Transient  $V_{OUT} = 5.0\text{ V}$

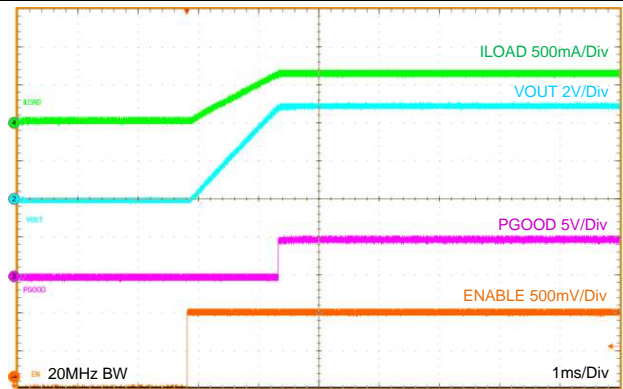

Figure 74. Startup  $V_{OUT} = 5.0\text{ V}$

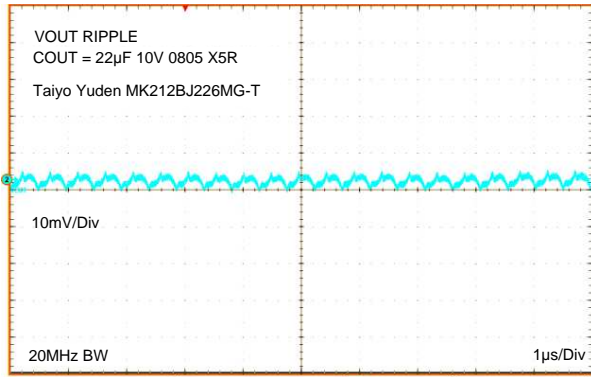

Figure 75. 20 MHz Oscilloscope Bandwidth Output Voltage Ripple  $V_{OUT} = 5.0\text{ V}$

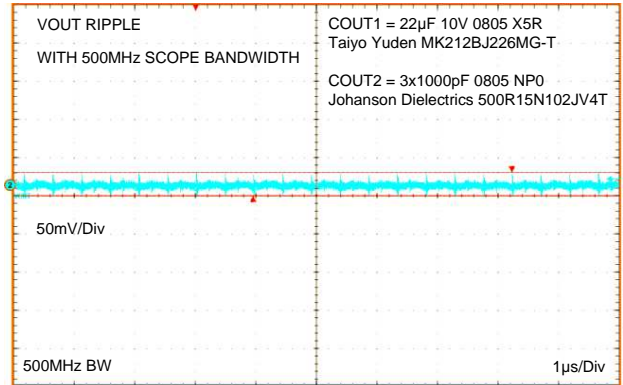

Figure 76. 500 MHz Oscilloscope Bandwidth, 3x1000 pF additional output capacitance Output Voltage Ripple and HF Noise  $V_{OUT} = 5.0\text{ V}$

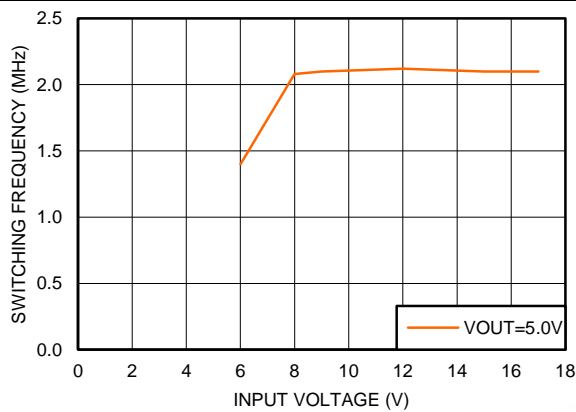

Figure 77. Typical Switching Frequency at 650 mA Load  $V_{OUT} = 5.0\text{ V}$

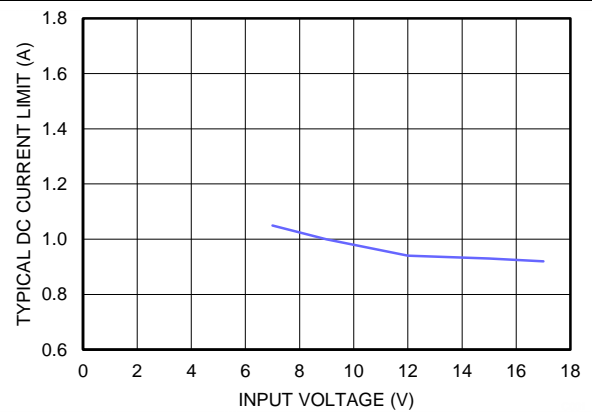

Figure 78. Typical Current Limit  $V_{OUT} = 5.0\text{ V}$ ,  $T_A = 85\text{ }^\circ\text{C}$

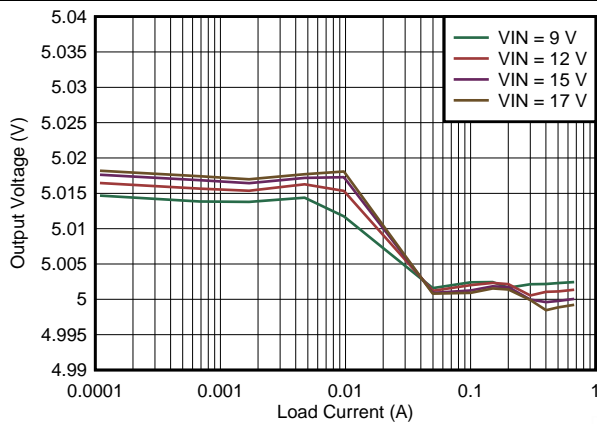

Figure 79. Line and Load Regulation  $V_{OUT} = 5.0\text{ V}$

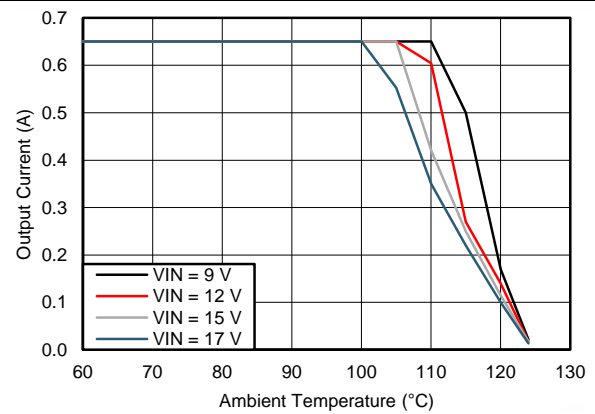

Figure 80. Thermal Derating for  $\theta_{JA} = 47^\circ\text{C/W}$ ,  $V_{OUT} = 5.0\text{ V}$

### 9.3 Do's and Don'ts

- DO NOT exceed the [Absolute Maximum Ratings](#).
- DO NOT exceed the [Recommended Operating Conditions](#).
- DO NOT exceed the [Handling Ratings](#).
- DO follow the [Detailed Design Procedure](#).
- DO follow the PCB [Layout Guidelines](#) and [Layout Example](#).
- DO follow the [Power Supply Recommendations](#).
- DO visit the [TI E2E Community Support Forum](#) to have your questions answered and designs reviewed.

## 10 Power Supply Recommendations

### 10.1 Voltage Range

The voltage of the input supply must not exceed the [Absolute Maximum Ratings](#) and the [Recommended Operating Conditions](#) of the LMZ21700.

### 10.2 Current Capability

The input supply must be able to supply the required input current to the LMZ21700 converter. The required input current depends on the application's minimum required input voltage ( $V_{IN-MIN}$ ), the required output power ( $V_{OUT} \times I_{OUT-MAX}$ ), and the converter efficiency ( $\eta$ ).

$$I_{IN} = V_{OUT} \times I_{OUT-MAX} / (V_{IN-MIN} \times \eta)$$

For example, for a design with 10 V minimum input voltage, 5 V output, and 0.5 A maximum load, considering 90 % conversion efficiency, the required input current is 0.278 A.

### 10.3 Input Connection

Long input connection cables can cause issues with the normal operation of any buck converter.

#### 10.3.1 Voltage Drops

Using long input wires to connect the supply to the input of any converter adds impedance in series with the input supply. This impedance can cause a voltage drop at the VIN pin of the converter when the output of the converter is loaded. If the input voltage is near the minimum operating voltage, this added voltage drop can cause the converter to drop out or reset. If long wires are used during testing, it is recommended to add some bulk (i.e. electrolytic) capacitance at the input of the converter.

#### 10.3.2 Stability

The added inductance of long input cables together with the ceramic (and low ESR) input capacitor can result in an under damped RLC network at the input of the Buck converter. This can cause oscillations on the input and instability. If long wires are used, it is recommended to add some electrolytic capacitance in parallel with the ceramic input capacitor. The electrolytic capacitor's ESR will improve the damping.

Use an electrolytic capacitor with  $C_{ELECTROLYTIC} \geq 4 \times C_{CERAMIC}$  and  $ESR_{ELECTROLYTIC} \approx \sqrt{L_{CABLE} / C_{CERAMIC}}$

For example, two cables (one for  $V_{IN}$  and one for GND), each 1 meter (~ 3 ft) long with ~1.0 mm diameter (18 AWG), placed 1 cm (~0.4 in) apart will form a rectangular loop resulting in about 1.2  $\mu$ H of inductance. The inductance in this example can be decreased to almost half if the input wires are twisted. Based on a 22  $\mu$ F ceramic input capacitor, the recommended parallel  $C_{ELECTROLYTIC}$  is  $\geq 88 \mu$ F. Using a 100  $\mu$ F capacitor will be sufficient. The recommended  $ESR_{ELECTROLYTIC} \approx 0.23 \Omega$  or larger, based on about 1.2  $\mu$ H of inductance and 22  $\mu$ F of ceramic input capacitance.

See application note [SNVA489C](#) for more details on input filter design.

## 11 Layout

### 11.1 Layout Guidelines

The PCB layout is critical for the proper operation of any DC-DC switching converter. Although using modules can simplify the PCB layout process, care should still be taken to minimize the inductance in the high di/dt loops and to protect sensitive nodes. The following guidelines should be followed when designing a board layout with the LMZ21700:

#### 11.1.1 Minimize the High di/dt Loop Area

The input capacitor, the  $V_{IN}$  terminal, and the GND terminal of the LMZ21700 form a high di/dt loop. Place the input capacitor as close as possible to the  $V_{IN}$  and GND terminals of the module IC. This minimizes the area of the high di/dt loop and results in lower inductance in the switching current path. Lower inductance in the switching current path translates to lower voltage spikes on the internal switch node and lower noise on the output voltage. Make the copper traces between the input capacitor and the  $V_{IN}$  and GND terminals wide and short for better current handling and minimized parasitic inductance.

#### 11.1.2 Protect the Sensitive Nodes in the Circuit

The feedback node is a sensitive circuit which can pick up noise. Make the feedback node as small as possible. This can be achieved by placing the feedback divider as close as possible to the IC. Use thin traces to the feedback pin in order to minimize the parasitic capacitance to other nodes. The feedback network carries very small current and thick traces are not necessary. Another sensitive node to protect is the VOS pin. Use a thin and short trace from the  $V_{OUT}$  terminal of the output capacitor to the VOS pin. The VOS pin is right next to the GND terminal. For very noisy systems, a small (0402 or 0201) 0.1  $\mu$ F capacitor can be placed from VOS to GND to filter high frequency noise on the VOS line.

#### 11.1.3 Provide Thermal Path and Shielding

Using the available layers in the PCB can help provide additional shielding and improved thermal performance. Large unbroken GND copper areas provide good thermal and return current paths. Flood unused PCB area with GND copper. Use thermal vias to connect the GND copper between layers.

The required board area for proper thermal dissipation can be estimated using the power dissipation curves for the desired output voltage and the package thermal resistance vs. board area curve. Refer to the power dissipation graphs in the [Typical Characteristics](#) section. Using the power dissipation ( $P_{DISS}$ ) for the designed input and output voltage and the max operating ambient temperature  $T_A$  for the application, estimate the required thermal resistance  $R_{\theta JA}$  with the following expression.

$$R_{\theta JA - \text{REQUIRED}} \leq (125 \text{ }^\circ\text{C} - T_A) / P_{DISS} \quad (8)$$

Then use [Figure 81](#) to estimate the board copper area required to achieve the calculated thermal resistance.

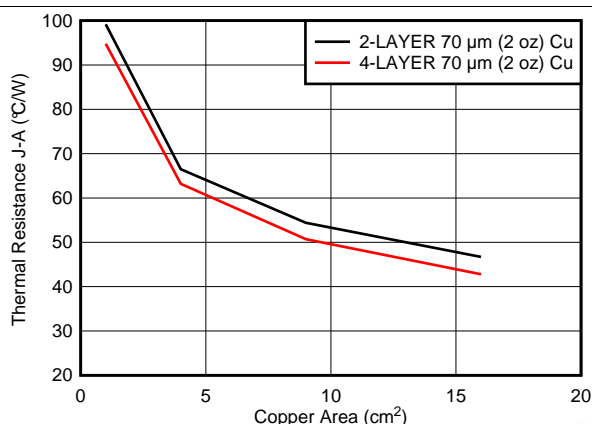

Figure 81. Package Thermal Resistance vs. Board Copper Area, No Air Flow

## Layout Guidelines (continued)

For example, for a design with 17 V input and 5 V output and 0.65 A load the power dissipation according to [Figure 8](#) is 0.43 W.

For 85 °C ambient temperature, the  $R_{\theta JA-REQUIRED}$  is  $\leq (125\text{ °C} - 85\text{ °C}) / 0.43\text{ W}$ , or  $\leq 93\text{ °C/W}$ . Looking at [Figure 81](#) the minimum copper area required to achieve this thermal resistance with a 4-layer board and 70  $\mu\text{m}$  (2 oz) copper is approximately 1  $\text{cm}^2$ .

### 11.2 Layout Example

The following example is for a 4-layer board. Layers 2 and 4 provide additional shielding and thermal path. If a 2-layer board is used, apply the Layer 1 and Layer 3 copper patterns for the top and bottom layers, respectively.

Layout Example (continued)

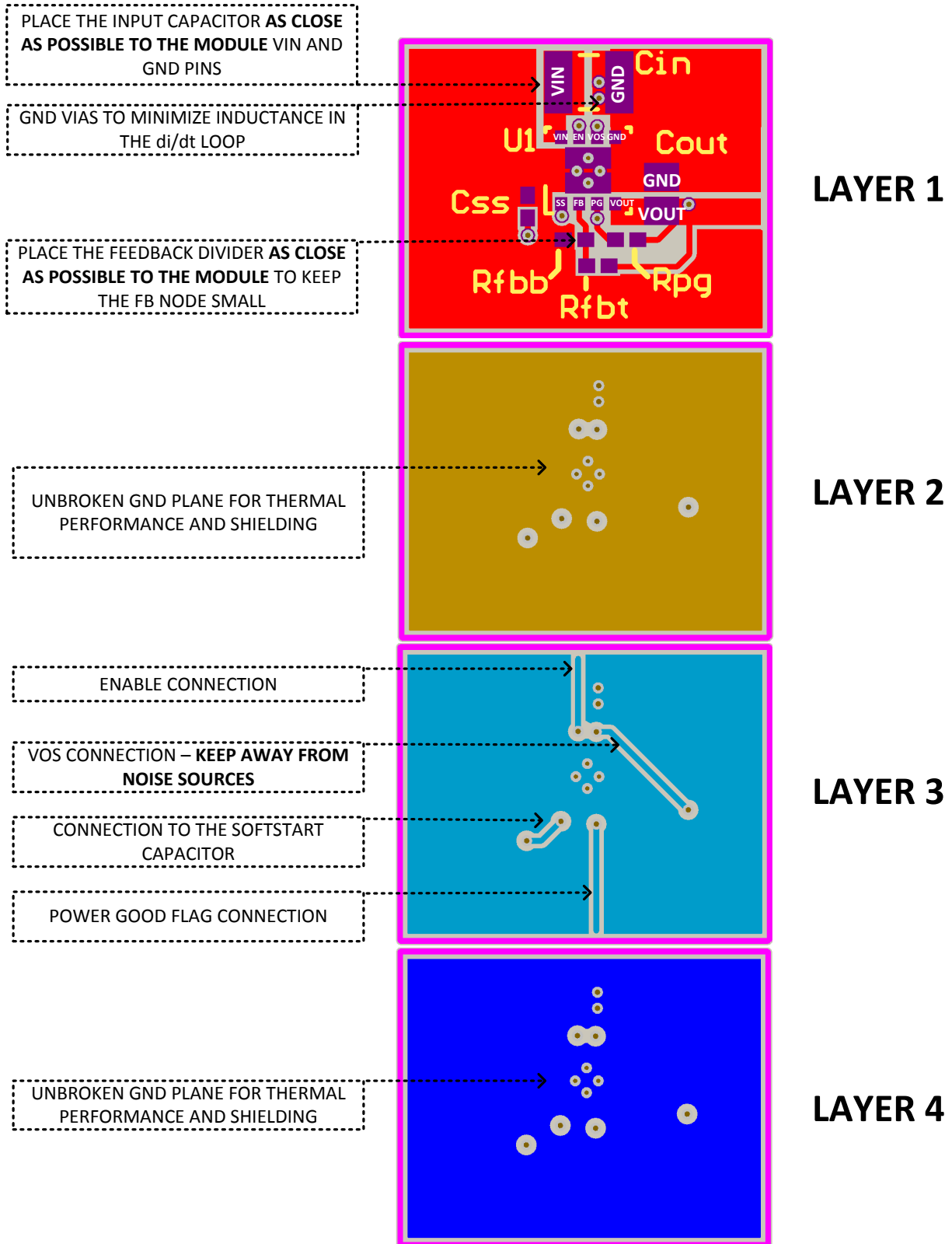
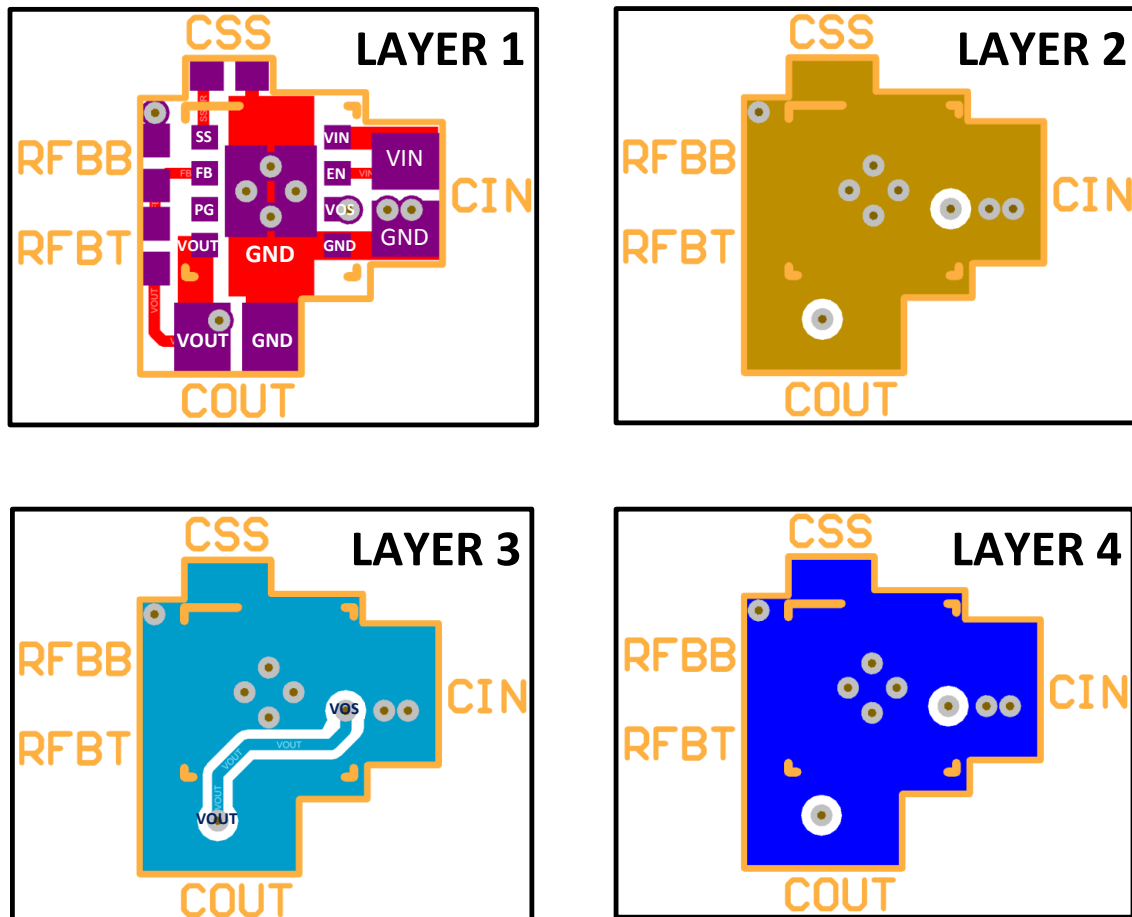

Figure 82. Layout example

**Layout Example (continued)**
**11.2.1 High Density Layout Example for Space Constrained Applications**
**11.2.1.1 35 mm<sup>2</sup> Solution Size (Single Sided)**

The following layout example uses 0805 case size components for the input and output capacitors and 0402 case size components for the rest of the passives.



**Figure 83. 35mm<sup>2</sup> Solution Size (Single Sided)**

## 12 Device and Documentation Support

### 12.1 Device Support

Visit the [TI E2E Community Support Forum](#) to have your questions answered and designs reviewed.

### 12.2 Trademarks

DCS-Control, MicroSiP are trademarks of Texas Instruments.

SIMPLE SWITCHER, WEBENCH are registered trademarks of Texas Instruments.

### 12.3 Electrostatic Discharge Caution



These devices have limited built-in ESD protection. The leads should be shorted together or the device placed in conductive foam during storage or handling to prevent electrostatic damage to the MOS gates.

### 12.4 Glossary

[SLYZ022](#) — *TI Glossary*.

This glossary lists and explains terms, acronyms, and definitions.

## 13 Mechanical, Packaging, and Orderable Information

The following pages include mechanical, packaging, and orderable information. This information is the most current data available for the designated devices. This data is subject to change without notice and revision of this document. For browser-based versions of this data sheet, refer to the left-hand navigation.

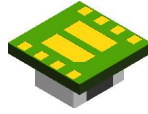

# PACKAGE OUTLINE

SIL0008E

MicroSiP™ - 1.75 mm max height

MICRO SYSTEM IN PACKAGE

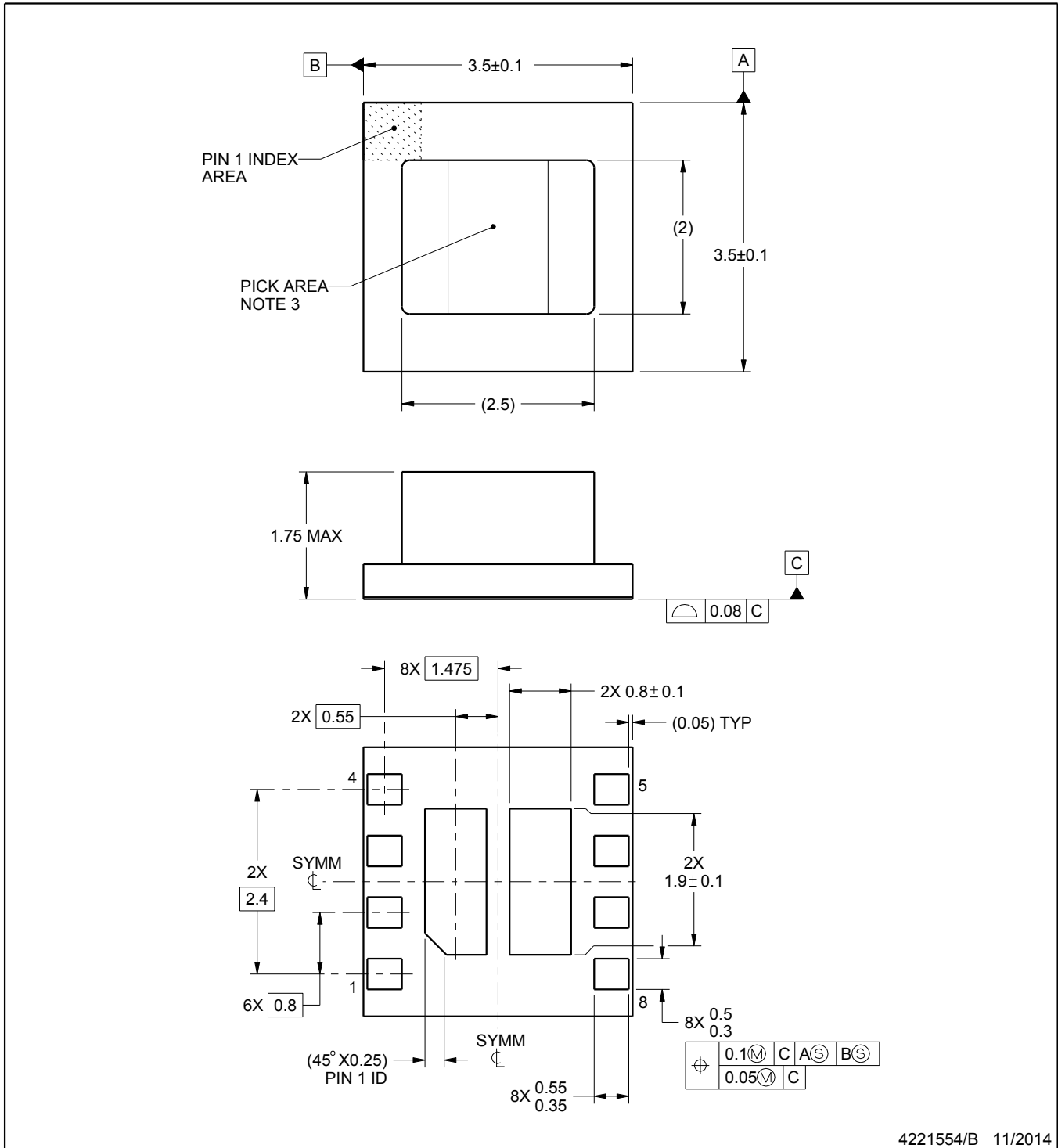

4221554/B 11/2014

MicroSiP is a trademark of Texas Instruments.

NOTES:

1. All linear dimensions are in millimeters. Any dimensions in parenthesis are for reference only. Dimensioning and tolerancing per ASME Y14.5M.
2. This drawing is subject to change without notice.
3. Pick and place nozzle  $\phi$  1.3 mm or smaller recommended.



# EXAMPLE STENCIL DESIGN

SIL0008E

MicroSiP™ - 1.75 mm max height

MICRO SYSTEM IN PACKAGE

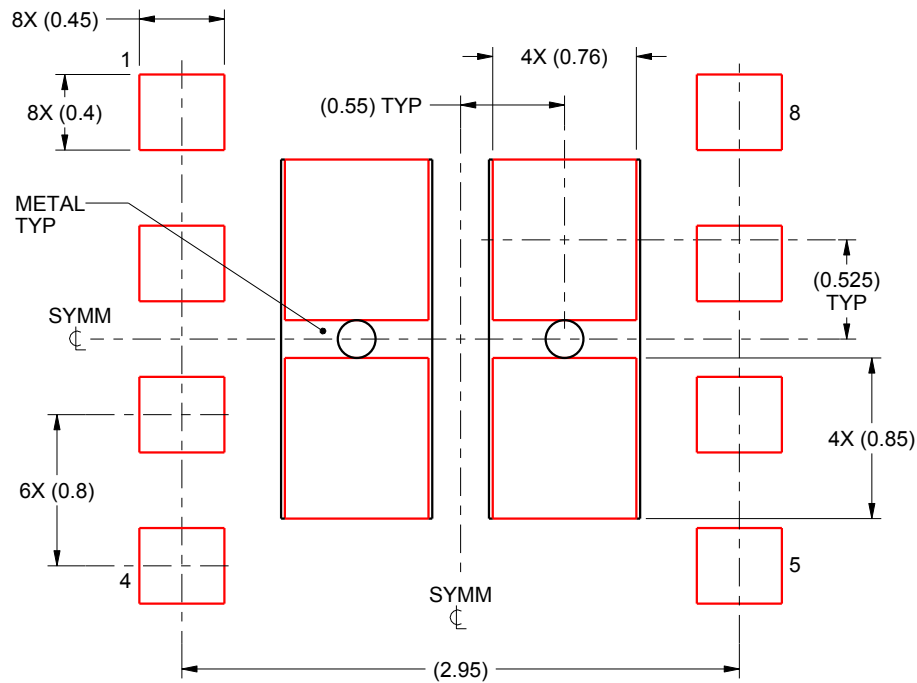

SOLDER PASTE EXAMPLE  
BASED ON 0.125 mm THICK STENCIL



EXPOSED PAD  
85% PRINTED SOLDER COVERAGE BY AREA  
SCALE:25X

4221554/B 11/2014

NOTES: (continued)

5. Laser cutting apertures with trapezoidal walls and rounded corners may offer better paste release. IPC-7525 may have alternate design recommendations.

**PACKAGING INFORMATION**

Orderable Device	Status (1)	Package Type	Package Drawing	Pins	Package Qty	Eco Plan (2)	Lead/Ball Finish (6)	MSL Peak Temp (3)	Op Temp (°C)	Device Marking (4/5)	Samples
LMZ21700SILR	ACTIVE	uSiP	SIL	8	3000	Green (RoHS & no Sb/Br)	Call TI	Level-5A-260C-24 HR	-40 to 125	TXN7204EC D9 7485 1700 1700 7485 D9	
LMZ21700SILT	ACTIVE	uSiP	SIL	8	250	Green (RoHS & no Sb/Br)	Call TI	Level-5A-260C-24 HR	-40 to 125	TXN7204EC D9 7485 1700 1700 7485 D9	

(1) The marketing status values are defined as follows:

**ACTIVE:** Product device recommended for new designs.

**LIFEBUY:** TI has announced that the device will be discontinued, and a lifetime-buy period is in effect.

**NRND:** Not recommended for new designs. Device is in production to support existing customers, but TI does not recommend using this part in a new design.

**PREVIEW:** Device has been announced but is not in production. Samples may or may not be available.

**OBSELETE:** TI has discontinued the production of the device.

(2) Eco Plan - The planned eco-friendly classification: Pb-Free (RoHS), Pb-Free (RoHS Exempt), or Green (RoHS & no Sb/Br) - please check <http://www.ti.com/productcontent> for the latest availability information and additional product content details.

**TBD:** The Pb-Free/Green conversion plan has not been defined.

**Pb-Free (RoHS):** TI's terms "Lead-Free" or "Pb-Free" mean semiconductor products that are compatible with the current RoHS requirements for all 6 substances, including the requirement that lead not exceed 0.1% by weight in homogeneous materials. Where designed to be soldered at high temperatures, TI Pb-Free products are suitable for use in specified lead-free processes.

**Pb-Free (RoHS Exempt):** This component has a RoHS exemption for either 1) lead-based flip-chip solder bumps used between the die and package, or 2) lead-based die adhesive used between the die and leadframe. The component is otherwise considered Pb-Free (RoHS compatible) as defined above.

**Green (RoHS & no Sb/Br):** TI defines "Green" to mean Pb-Free (RoHS compatible), and free of Bromine (Br) and Antimony (Sb) based flame retardants (Br or Sb do not exceed 0.1% by weight in homogeneous material)

(3) MSL, Peak Temp. - The Moisture Sensitivity Level rating according to the JEDEC industry standard classifications, and peak solder temperature.

(4) There may be additional marking, which relates to the logo, the lot trace code information, or the environmental category on the device.

(5) Multiple Device Markings will be inside parentheses. Only one Device Marking contained in parentheses and separated by a "~" will appear on a device. If a line is indented then it is a continuation of the previous line and the two combined represent the entire Device Marking for that device.

(6) Lead/Ball Finish - Orderable Devices may have multiple material finish options. Finish options are separated by a vertical ruled line. Lead/Ball Finish values may wrap to two lines if the finish value exceeds the maximum column width.

**Important Information and Disclaimer:** The information provided on this page represents TI's knowledge and belief as of the date that it is provided. TI bases its knowledge and belief on information provided by third parties, and makes no representation or warranty as to the accuracy of such information. Efforts are underway to better integrate information from third parties. TI has taken and continues to take reasonable steps to provide representative and accurate information but may not have conducted destructive testing or chemical analysis on incoming materials and chemicals. TI and TI suppliers consider certain information to be proprietary, and thus CAS numbers and other limited information may not be available for release.

In no event shall TI's liability arising out of such information exceed the total purchase price of the TI part(s) at issue in this document sold by TI to Customer on an annual basis.

**TAPE AND REEL INFORMATION**

**QUADRANT ASSIGNMENTS FOR PIN 1 ORIENTATION IN TAPE**

\*All dimensions are nominal

Device	Package Type	Package Drawing	Pins	SPQ	Reel Diameter (mm)	Reel Width W1 (mm)	A0 (mm)	B0 (mm)	K0 (mm)	P1 (mm)	W (mm)	Pin1 Quadrant
LMZ21700SILR	uSiP	SIL	8	3000	330.0	12.4	3.75	3.75	2.2	8.0	12.0	Q2
LMZ21700SILT	uSiP	SIL	8	250	330.0	12.4	3.75	3.75	2.2	8.0	12.0	Q2

**TAPE AND REEL BOX DIMENSIONS**

\*All dimensions are nominal

Device	Package Type	Package Drawing	Pins	SPQ	Length (mm)	Width (mm)	Height (mm)
LMZ21700SILR	uSiP	SIL	8	3000	383.0	353.0	58.0
LMZ21700SILT	uSiP	SIL	8	250	383.0	353.0	58.0

## IMPORTANT NOTICE

Texas Instruments Incorporated and its subsidiaries (TI) reserve the right to make corrections, enhancements, improvements and other changes to its semiconductor products and services per JESD46, latest issue, and to discontinue any product or service per JESD48, latest issue. Buyers should obtain the latest relevant information before placing orders and should verify that such information is current and complete. All semiconductor products (also referred to herein as "components") are sold subject to TI's terms and conditions of sale supplied at the time of order acknowledgment.

TI warrants performance of its components to the specifications applicable at the time of sale, in accordance with the warranty in TI's terms and conditions of sale of semiconductor products. Testing and other quality control techniques are used to the extent TI deems necessary to support this warranty. Except where mandated by applicable law, testing of all parameters of each component is not necessarily performed.

TI assumes no liability for applications assistance or the design of Buyers' products. Buyers are responsible for their products and applications using TI components. To minimize the risks associated with Buyers' products and applications, Buyers should provide adequate design and operating safeguards.

TI does not warrant or represent that any license, either express or implied, is granted under any patent right, copyright, mask work right, or other intellectual property right relating to any combination, machine, or process in which TI components or services are used. Information published by TI regarding third-party products or services does not constitute a license to use such products or services or a warranty or endorsement thereof. Use of such information may require a license from a third party under the patents or other intellectual property of the third party, or a license from TI under the patents or other intellectual property of TI.

Reproduction of significant portions of TI information in TI data books or data sheets is permissible only if reproduction is without alteration and is accompanied by all associated warranties, conditions, limitations, and notices. TI is not responsible or liable for such altered documentation. Information of third parties may be subject to additional restrictions.

Resale of TI components or services with statements different from or beyond the parameters stated by TI for that component or service voids all express and any implied warranties for the associated TI component or service and is an unfair and deceptive business practice. TI is not responsible or liable for any such statements.

Buyer acknowledges and agrees that it is solely responsible for compliance with all legal, regulatory and safety-related requirements concerning its products, and any use of TI components in its applications, notwithstanding any applications-related information or support that may be provided by TI. Buyer represents and agrees that it has all the necessary expertise to create and implement safeguards which anticipate dangerous consequences of failures, monitor failures and their consequences, lessen the likelihood of failures that might cause harm and take appropriate remedial actions. Buyer will fully indemnify TI and its representatives against any damages arising out of the use of any TI components in safety-critical applications.

In some cases, TI components may be promoted specifically to facilitate safety-related applications. With such components, TI's goal is to help enable customers to design and create their own end-product solutions that meet applicable functional safety standards and requirements. Nonetheless, such components are subject to these terms.

No TI components are authorized for use in FDA Class III (or similar life-critical medical equipment) unless authorized officers of the parties have executed a special agreement specifically governing such use.

Only those TI components which TI has specifically designated as military grade or "enhanced plastic" are designed and intended for use in military/aerospace applications or environments. Buyer acknowledges and agrees that any military or aerospace use of TI components which have **not** been so designated is solely at the Buyer's risk, and that Buyer is solely responsible for compliance with all legal and regulatory requirements in connection with such use.

TI has specifically designated certain components as meeting ISO/TS16949 requirements, mainly for automotive use. In any case of use of non-designated products, TI will not be responsible for any failure to meet ISO/TS16949.

### Products

Audio	<a href="http://www.ti.com/audio">www.ti.com/audio</a>
Amplifiers	<a href="http://amplifier.ti.com">amplifier.ti.com</a>
Data Converters	<a href="http://dataconverter.ti.com">dataconverter.ti.com</a>
DLP® Products	<a href="http://www.dlp.com">www.dlp.com</a>
DSP	<a href="http://dsp.ti.com">dsp.ti.com</a>
Clocks and Timers	<a href="http://www.ti.com/clocks">www.ti.com/clocks</a>
Interface	<a href="http://interface.ti.com">interface.ti.com</a>
Logic	<a href="http://logic.ti.com">logic.ti.com</a>
Power Mgmt	<a href="http://power.ti.com">power.ti.com</a>
Microcontrollers	<a href="http://microcontroller.ti.com">microcontroller.ti.com</a>
RFID	<a href="http://www.ti-rfid.com">www.ti-rfid.com</a>
OMAP Applications Processors	<a href="http://www.ti.com/omap">www.ti.com/omap</a>
Wireless Connectivity	<a href="http://www.ti.com/wirelessconnectivity">www.ti.com/wirelessconnectivity</a>

### Applications

Automotive and Transportation	<a href="http://www.ti.com/automotive">www.ti.com/automotive</a>
Communications and Telecom	<a href="http://www.ti.com/communications">www.ti.com/communications</a>
Computers and Peripherals	<a href="http://www.ti.com/computers">www.ti.com/computers</a>
Consumer Electronics	<a href="http://www.ti.com/consumer-apps">www.ti.com/consumer-apps</a>
Energy and Lighting	<a href="http://www.ti.com/energy">www.ti.com/energy</a>
Industrial	<a href="http://www.ti.com/industrial">www.ti.com/industrial</a>
Medical	<a href="http://www.ti.com/medical">www.ti.com/medical</a>
Security	<a href="http://www.ti.com/security">www.ti.com/security</a>
Space, Avionics and Defense	<a href="http://www.ti.com/space-avionics-defense">www.ti.com/space-avionics-defense</a>
Video and Imaging	<a href="http://www.ti.com/video">www.ti.com/video</a>

### TI E2E Community

[e2e.ti.com](http://e2e.ti.com)