

Distributed by:

**JAMECO**<sup>®</sup>  
ELECTRONICS

**www.Jameco.com ♦ 1-800-831-4242**

The content and copyrights of the attached  
material are the property of its owner.

Jameco Part Number 1995089

# LMV771/LMV772/LMV774

## Single/Dual/Quad, Low Offset, Low Noise, RRO Operational Amplifiers

### General Description

The LMV771/LMV772/LMV774 are Single, Dual, and Quad low noise precision operational amplifiers intended for use in a wide range of applications. Other important characteristics of the family include: an extended operating temperature range of  $-40^{\circ}\text{C}$  to  $125^{\circ}\text{C}$ , the tiny SC70-5 package for the LMV771, and low input bias current.

The extended temperature range of  $-40^{\circ}\text{C}$  to  $125^{\circ}\text{C}$  allows the LMV771/LMV772/LMV774 to accommodate a broad range of applications. The LMV771 expands National Semiconductor's Silicon Dust™ amplifier portfolio offering enhancements in size, speed, and power savings. The LMV771/LMV772/LMV774 are guaranteed to operate over the voltage range of 2.7V to 5.0V and all have rail-to-rail output.

The LMV771/LMV772/LMV774 family is designed for precision, low noise, low voltage, and miniature systems. These amplifiers provide rail-to-rail output swing into heavy loads. The maximum input offset voltage for the LMV771 is  $850\ \mu\text{V}$  at room temperature and the input common mode voltage range includes ground.

The LMV771 is offered in the tiny SC70-5 package, LMV772 in the space saving MSOP-8 and SOIC-8, and the LMV774 in TSSOP-14.

### Features

(Unless otherwise noted, typical values at  $V_S = 2.7\text{V}$ )

- Guaranteed 2.7V and 5V specifications
- Maximum  $V_{OS}$  (LMV771) 850 $\mu\text{V}$  (limit)
- Voltage noise
  - $f = 100\ \text{Hz}$  12.5nV/ $\sqrt{\text{Hz}}$
  - $f = 10\ \text{kHz}$  7.5nV/ $\sqrt{\text{Hz}}$
- Rail-to-Rail output swing
  - $R_L = 600\ \Omega$  100mV from rail
  - $R_L = 2\ \text{k}\Omega$  50mV from rail
- Open loop gain with  $R_L = 2\ \text{k}\Omega$  100dB
- $V_{CM}$  0 to  $V^+ - 0.9\text{V}$
- Supply current (per amplifier) 550 $\mu\text{A}$
- Gain bandwidth product 3.5MHz
- Temperature range  $-40^{\circ}\text{C}$  to  $125^{\circ}\text{C}$

### Applications

- Transducer amplifier
- Instrumentation amplifier
- Precision current sensing
- Data acquisition systems
- Active filters and buffers
- Sample and hold
- Portable/battery powered electronics

### Connection Diagram

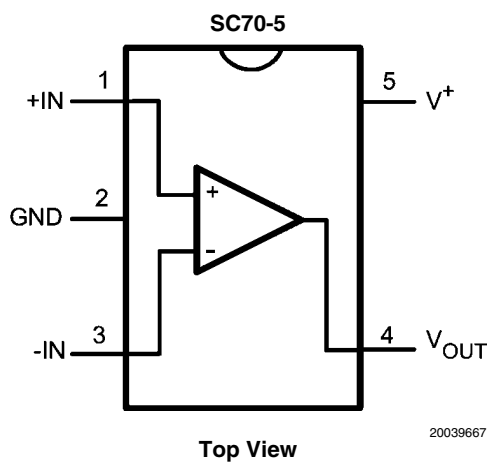

20039667

### Instrumentation Amplifier

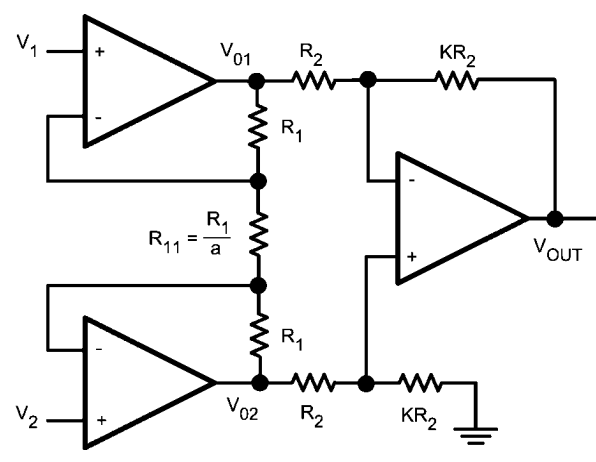

20039636

$$V_O = -K(2a + 1)(V_1 - V_2)$$

**Absolute Maximum Ratings** (Note 1)

If Military/Aerospace specified devices are required, please contact the National Semiconductor Sales Office/Distributors for availability and specifications.

ESD Tolerance (Note 2)	
Machine Model	200V
Human Body Model	2000V
Differential Input Voltage	$\pm$ Supply Voltage
Voltage at Input Pins	(V <sup>+</sup> ) + 0.3V, (V <sup>-</sup> ) - 0.3V
Current at Input Pins	$\pm$ 10 mA
Supply Voltage (V <sup>+</sup> -V <sup>-</sup> )	5.75V
Output Short Circuit to V <sup>+</sup>	(Note 3)
Output Short Circuit to V <sup>-</sup>	(Note 4)
Mounting Temperature	

Infrared or Convection (20 sec)	235°C
Wave Soldering Lead Temp (10 sec)	260°C
Storage Temperature Range	-65°C to 150°C
Junction Temperature (Note 5)	150°C

**Operating Ratings** (Note 1)

Supply Voltage	2.7V to 5.5V
Temperature Range	-40°C to 125°C
Thermal Resistance ( $\theta_{JA}$ )	
SC70-5 Package	440 °C/W
8-Pin MSOP	235°C/W
8-Pin SOIC	190°C/W
14-Pin TSSOP	155°C/W

**2.7V DC Electrical Characteristics** (Note 13)

Unless otherwise specified, all limits are guaranteed for T<sub>A</sub> = 25°C. V<sup>+</sup> = 2.7V, V<sup>-</sup> = 0V, V<sub>CM</sub> = V<sup>+</sup>/2, V<sub>O</sub> = V<sup>+</sup>/2 and R<sub>L</sub> > 1M $\Omega$ . **Boldface** limits apply at the temperature extremes.

Symbol	Parameter	Condition	Min (Note 7)	Typ (Note 6)	Max (Note 7)	Units
V <sub>OS</sub>	Input Offset Voltage	LMV771		0.3	0.85 <b>1.0</b>	mV
		LMV772/LMV774		0.3	1.0 <b>1.2</b>	
TCV <sub>OS</sub>	Input Offset Voltage Average Drift			-0.45		$\mu$ V/°C
I <sub>B</sub>	Input Bias Current (Note 8)	V <sub>CM</sub> = 1V		-0.1	100 <b>250</b>	pA
I <sub>OS</sub>	Input Offset Current (Note 8)			0.004	100	pA
I <sub>S</sub>	Supply Current (Per Amplifier)			550	900 <b>910</b>	$\mu$ A
CMRR	Common Mode Rejection Ratio	0.5 $\leq$ V <sub>CM</sub> $\leq$ 1.2V	74 <b>72</b>	80		dB
PSSR	Power Supply Rejection Ratio	2.7V $\leq$ V <sup>+</sup> $\leq$ 5V	82 <b>76</b>	90		dB
V <sub>CM</sub>	Input Common-Mode Voltage Range	For CMRR $\geq$ 50dB	0		1.8	V
A <sub>V</sub>	Large Signal Voltage Gain (Note 9)	R <sub>L</sub> = 600 $\Omega$ to 1.35V, V <sub>O</sub> = 0.2V to 2.5V, (Note 10)	92 <b>80</b>	100		dB
		R <sub>L</sub> = 2k $\Omega$ to 1.35V, V <sub>O</sub> = 0.2V to 2.5V, (Note 11)	98 <b>86</b>	100		
V <sub>O</sub>	Output Swing	R <sub>L</sub> = 600 $\Omega$ to 1.35V, V <sub>IN</sub> = $\pm$ 100mV, (Note 10)	0.11 <b>0.14</b>	0.084 to 2.62	2.59 <b>2.56</b>	V
		R <sub>L</sub> = 2k $\Omega$ to 1.35V, V <sub>IN</sub> = $\pm$ 100mV, (Note 11)	0.05 <b>0.06</b>	0.026 to 2.68	2.65 <b>2.64</b>	
I <sub>O</sub>	Output Short Circuit Current	Sourcing, V <sub>O</sub> = 0V, V <sub>IN</sub> = 100mV	18 <b>11</b>	24		mA
		Sinking, V <sub>O</sub> = 2.7V, V <sub>IN</sub> = -100mV	18 <b>11</b>	22		

## 2.7V AC Electrical Characteristics (Note 13)

Unless otherwise specified, all limits are guaranteed for  $T_A = 25^\circ\text{C}$ .  $V^+ = 5.0\text{V}$ ,  $V^- = 0\text{V}$ ,  $V_{CM} = V^+/2$ ,  $V_O = V^+/2$  and  $R_L > 1\text{M}\Omega$ .

**Boldface** limits apply at the temperature extremes.

Symbol	Parameter	Conditions	Min (Note 7)	Typ (Note 6)	Max (Note 7)	Units
SR	Slew Rate (Note 12)	$A_V = +1$ , $R_L = 10\text{ k}\Omega$		1.4		V/ $\mu\text{s}$
GBW	Gain-Bandwidth Product			3.5		MHz
$\phi_m$	Phase Margin			79		Deg
$G_m$	Gain Margin			-15		dB
$e_n$	Input-Referred Voltage Noise (Flatband)	$f = 10\text{kHz}$		7.5		$\text{nV}/\sqrt{\text{Hz}}$
$e_n$	Input-Referred Voltage Noise (1/f)	$f = 100\text{Hz}$		12.5		$\text{nV}/\sqrt{\text{Hz}}$
$i_n$	Input-Referred Current Noise	$f = 1\text{kHz}$		0.001		$\text{pA}/\sqrt{\text{Hz}}$
THD	Total Harmonic Distortion	$f = 1\text{kHz}$ , $A_V = +1$ $R_L = 600\Omega$ , $V_{IN} = 1\text{ V}_{PP}$		0.007		%

## 5.0V DC Electrical Characteristics (Note 13)

Unless otherwise specified, all limits are guaranteed for  $T_A = 25^\circ\text{C}$ .  $V^+ = 5.0\text{V}$ ,  $V^- = 0\text{V}$ ,  $V_{CM} = V^+/2$ ,  $V_O = V^+/2$  and  $R_L > 1\text{M}\Omega$ . **Boldface** limits apply at the temperature extremes.

**Boldface** limits apply at the temperature extremes.

Symbol	Parameter	Condition	Min (Note 7)	Typ (Note 6)	Max (Note 7)	Units
$V_{OS}$	Input Offset Voltage	LMV771		0.25	0.85	mV
		LMV772/LMV774		0.25	1.0 <b>1.2</b>	
$TCV_{OS}$	Input Offset Voltage Average Drift			-0.35		$\mu\text{V}/^\circ\text{C}$
$I_B$	Input Bias Current (Note 8)	$V_{CM} = 1\text{V}$		-0.23	100 <b>250</b>	$\mu\text{A}$
$I_{OS}$	Input Offset Current (Note 8)			0.017	100	$\mu\text{A}$
$I_S$	Supply Current (Per Amplifier)			600	950 <b>960</b>	$\mu\text{A}$
CMRR	Common Mode Rejection Ratio	$0.5 \leq V_{CM} \leq 3.5\text{V}$	80 <b>79</b>	90		dB
PSRR	Power Supply Rejection Ratio	$2.7\text{V} \leq V^+ \leq 5\text{V}$	82 <b>76</b>	90		dB
$V_{CM}$	Input Common-Mode Voltage Range	For CMRR $\geq 50\text{dB}$	0		4.1	V
$A_V$	Large Signal Voltage Gain (Note 9)	$R_L = 600\Omega$ to 2.5V, $V_O = 0.2\text{V}$ to 4.8V, (Note 10)	92 <b>89</b>	100		dB
		$R_L = 2\text{k}\Omega$ to 2.5V, $V_O = 0.2\text{V}$ to 4.8V, (Note 11)	98 <b>95</b>	100		
$V_O$	Output Swing	$R_L = 600\Omega$ to 2.5V $V_{IN} = \pm 100\text{mV}$ , (Note 10)	0.15 <b>0.23</b>	0.112 to 4.9	4.85 <b>4.77</b>	V
		$R_L = 2\text{k}\Omega$ to 2.5V $V_{IN} = \pm 100\text{mV}$ , (Note 11)	0.06 <b>0.07</b>	0.035 to 4.97	4.94 <b>4.93</b>	
$I_O$	Output Short Circuit Current (Note 8),(Note 14)	Sourcing, $V_O = 0\text{V}$ $V_{IN} = 100\text{mV}$	35 <b>35</b>	75		mA
		Sinking, $V_O = 2.7\text{V}$ $V_{IN} = -100\text{mV}$	35 <b>35</b>	66		

## 5.0V AC Electrical Characteristics (Note 13)

Unless otherwise specified, all limits are guaranteed for  $T_A = 25^\circ\text{C}$ .  $V^+ = 5.0\text{V}$ ,  $V^- = 0\text{V}$ ,  $V_{\text{CM}} = V^+/2$ ,  $V_O = V^+/2$  and  $R_L > 1\text{M}\Omega$ .

**Boldface** limits apply at the temperature extremes.

Symbol	Parameter	Conditions	Min (Note 7)	Typ (Note 6)	Max (Note 7)	Units
SR	Slew Rate (Note 12)	$A_V = +1$ , $R_L = 10\text{ k}\Omega$		1.4		V/ $\mu\text{s}$
GBW	Gain-Bandwidth Product			3.5		MHz
$\Phi_m$	Phase Margin			79		Deg
$G_m$	Gain Margin			-15		dB
$e_n$	Input-Referred Voltage Noise (Flatband)	$f = 10\text{kHz}$		6.5		$\text{nV}/\sqrt{\text{Hz}}$
$e_n$	Input-Referred Voltage Noise (1/f)	$f = 100\text{Hz}$		12		$\text{nV}/\sqrt{\text{Hz}}$
$i_n$	Input-Referred Current Noise	$f = 1\text{kHz}$		0.001		$\text{pA}/\sqrt{\text{Hz}}$
THD	Total Harmonic Distortion	$f = 1\text{kHz}$ , $A_V = +1$ $R_L = 600\Omega$ , $V_{\text{IN}} = 1\text{ V}_{\text{PP}}$		0.007		%

**Note 1:** Absolute Maximum Ratings indicate limits beyond which damage to the device may occur. Operating Ratings indicate conditions for which the device is intended to be functional, but specific performance is not guaranteed. For guaranteed specifications and the test conditions, see the Electrical Characteristics.

**Note 2:** Human Body Model is  $1.5\text{ k}\Omega$  in series with  $100\text{ pF}$ . Machine Model is  $0\Omega$  in series with  $20\text{ pF}$ .

**Note 3:** Shorting output to  $V^+$  will adversely affect reliability.

**Note 4:** Shorting output to  $V^-$  will adversely affect reliability.

**Note 5:** The maximum power dissipation is a function of  $T_{\text{J(MAX)}}$ ,  $\theta_{\text{JA}}$ , and  $T_A$ . The maximum allowable power dissipation at any ambient temperature is  $P_D = (T_{\text{J(MAX)}} - T_A) / \theta_{\text{JA}}$ . All numbers apply for packages soldered directly into a PC board.

**Note 6:** Typical values represent the most likely parametric norm.

**Note 7:** All limits are guaranteed by testing or statistical analysis.

**Note 8:** Limits guaranteed by design.

**Note 9:**  $R_L$  is connected to mid-supply. The output voltage is set at  $200\text{mV}$  from the rails.  $V_O = \text{GND} + 0.2\text{V}$  and  $V_O = V^+ - 0.2\text{V}$

**Note 10:** For LMV772/LMV774, temperature limits apply to  $-40^\circ\text{C}$  to  $85^\circ\text{C}$ .

**Note 11:** For LMV772/LMV774, temperature limits apply to  $-40^\circ\text{C}$  to  $85^\circ\text{C}$ . If  $R_L$  is relaxed to  $10\text{ k}\Omega$ , then for LMV772/LMV774 temperature limits apply to  $-40^\circ\text{C}$  to  $125^\circ\text{C}$ .

**Note 12:** The number specified is the slower of positive and negative slew rates.

**Note 13:** Electrical Table values apply only for factory testing conditions at the temperature indicated. Factory testing conditions result in very limited self-heating of the device such that  $T_J = T_A$ .

**Note 14:** Continuous operation of the device with an output short circuit current larger than  $35\text{mA}$  may cause permanent damage to the device.

## Connection Diagrams

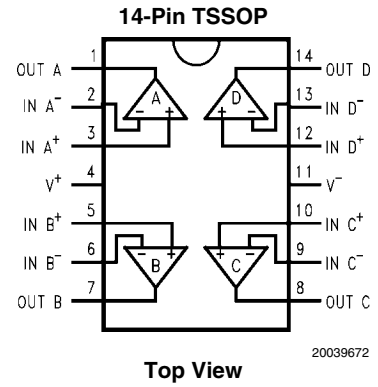
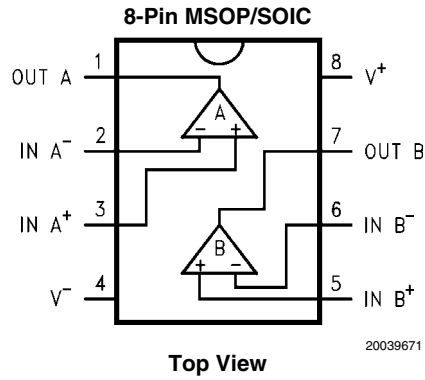
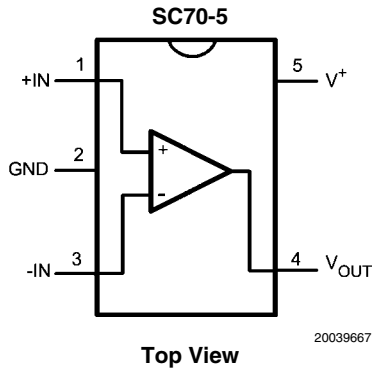

## Ordering Information

Package	Part Number	Package Marking	Transport Media	NSC Drawing
SC70-5	LMV771MG	A75	1k Units Tape and Reel	MAA05A
	LMV771MGX		3k Units Tape and Reel	
8-Pin SOIC	LMV772MA	LMV772MA	95 Units/Rail	M08A
	LMV772MAX		2.5k Units Tape and Reel	
8-Pin MSOP	LMV772MM	A91A	1k Units Tape and Reel	MUA08A
	LMV772MMX		3.5k Units Tape and Reel	
14-Pin TSSOP	LMV774MT	LMV774MT	94 Units/Rail	MTC14
	LMV774MTX		2.5k Units Tape and Reel	

# Typical Performance Characteristics

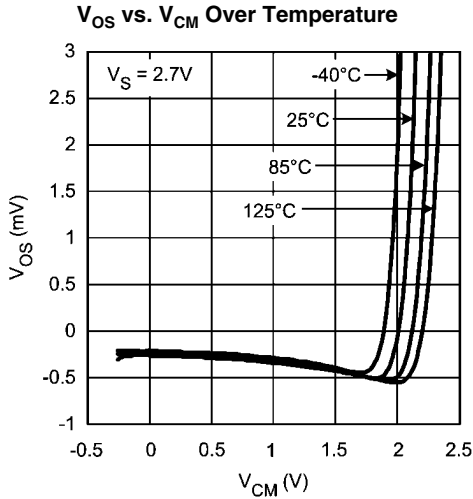

20039627

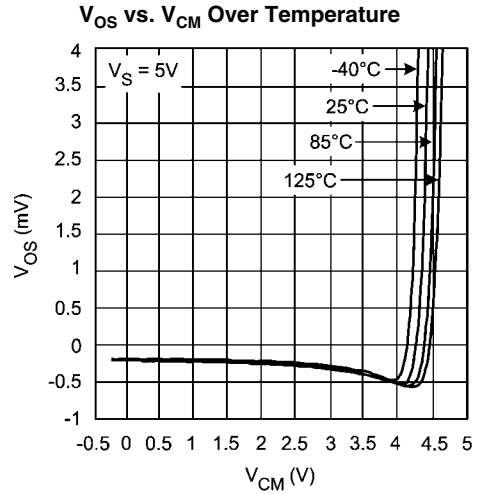

20039626

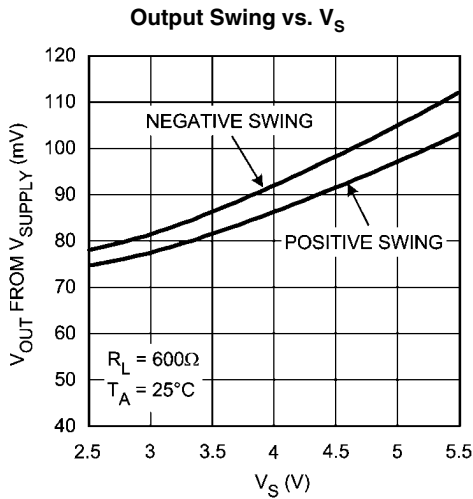

20039625

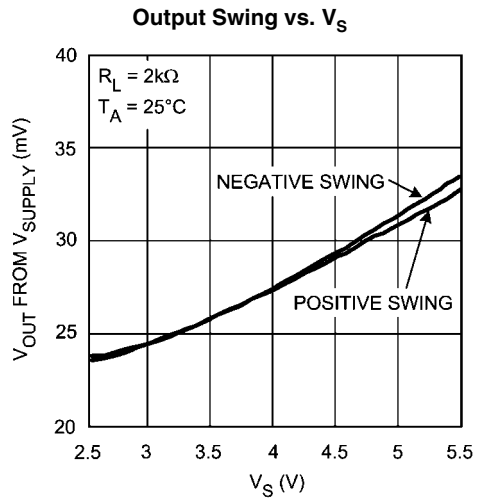

20039624

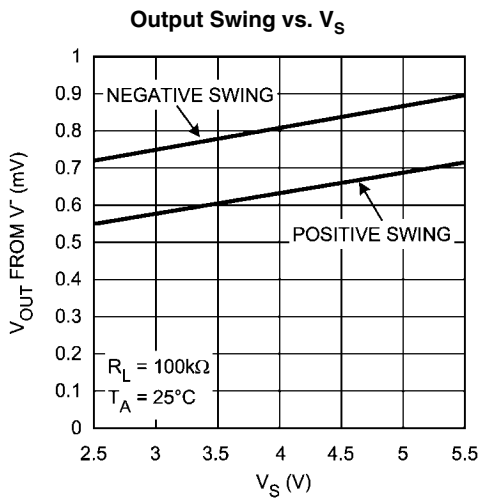

20039623

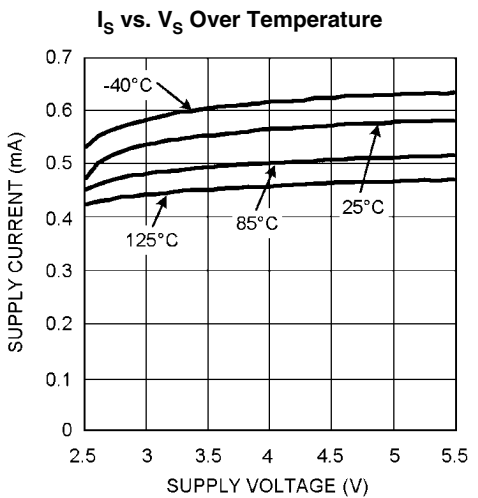

20039630

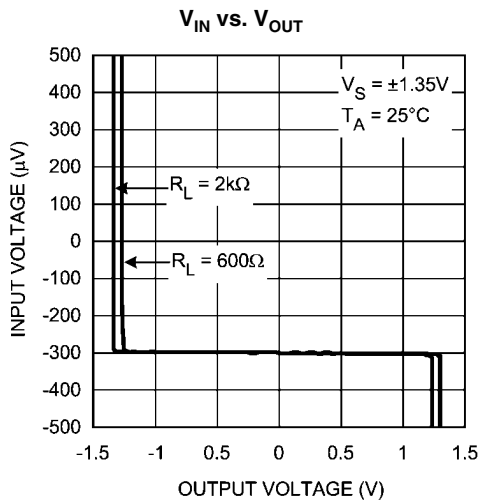

20039628

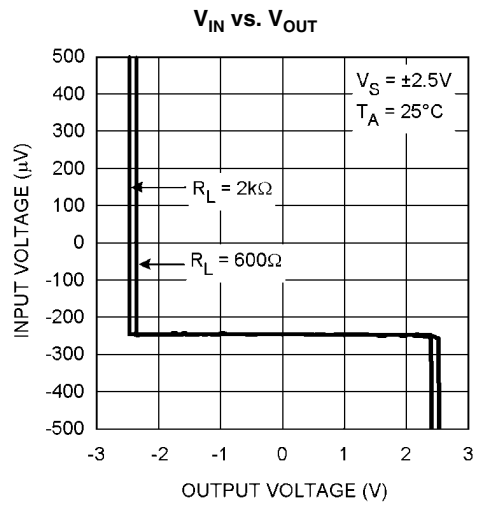

20039629

Sourcing Current vs. V<sub>OUT</sub> (Note 14)

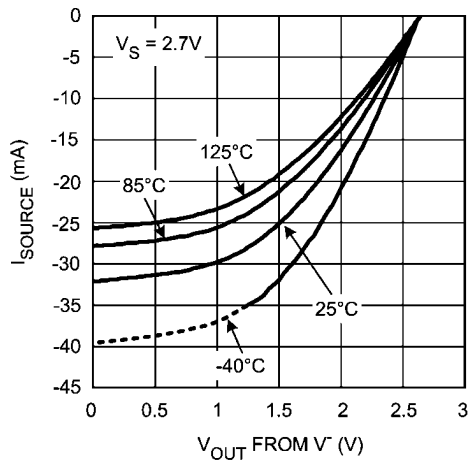

20039631

Sourcing Current vs. V<sub>OUT</sub> (Note 14)

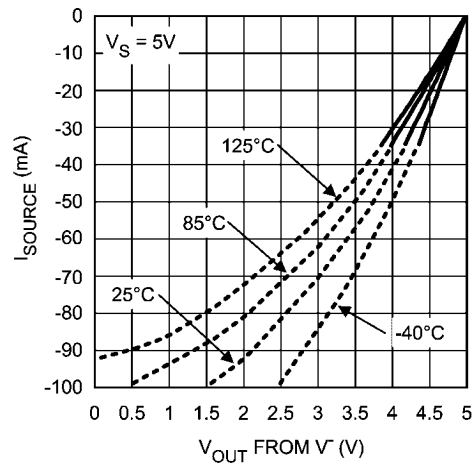

20039664

Sinking Current vs. V<sub>OUT</sub> (Note 14)

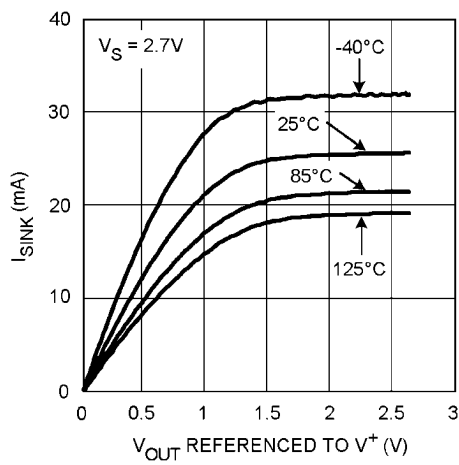

20039632

Sinking Current vs. V<sub>OUT</sub> (Note 14)

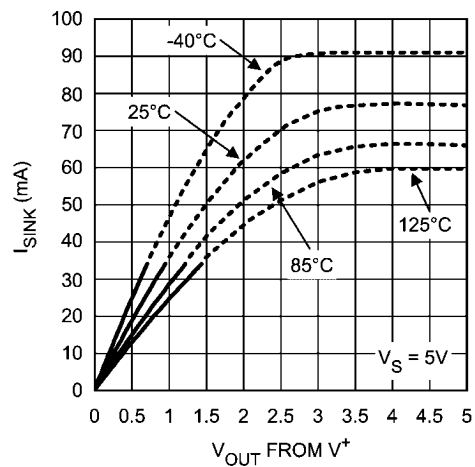

20039663

Input Voltage Noise vs. Frequency

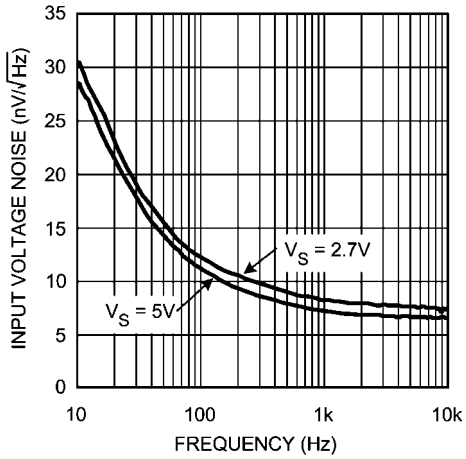

20039608

Input Bias Current Over Temperature

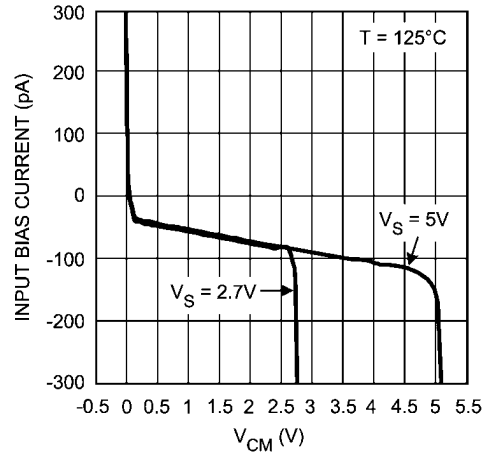

20039635

Input Bias Current Over Temperature

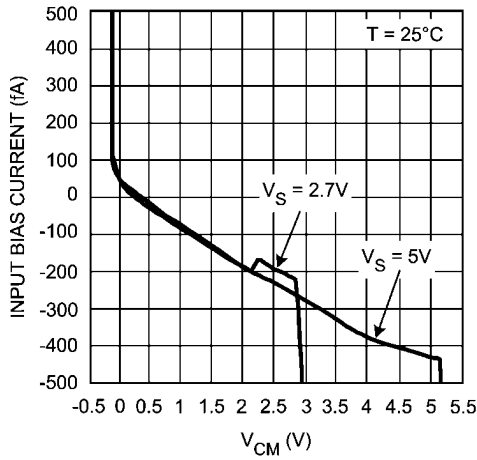

20039634

Input Bias Current Over Temperature

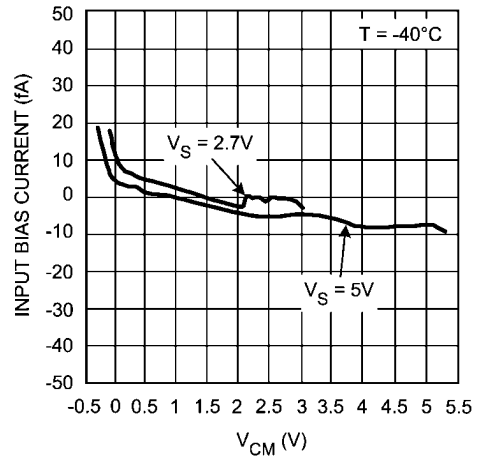

20039633

THD+N vs. Frequency

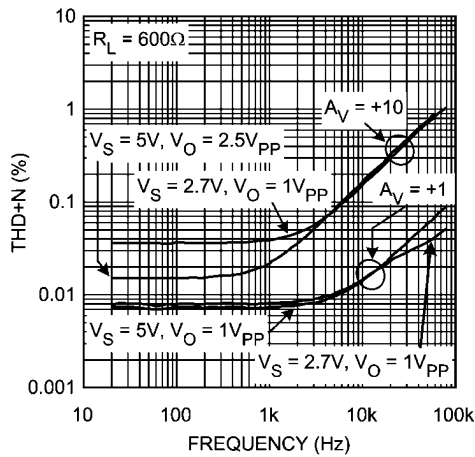

20039607

THD+N vs. VOUT

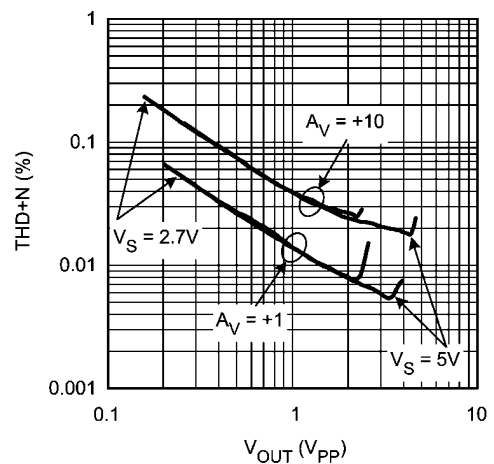

20039666

Slew Rate vs. Supply Voltage

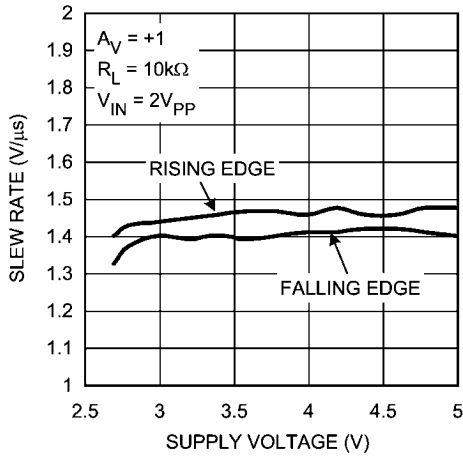

20039601

Open Loop Frequency Response Over Temperature

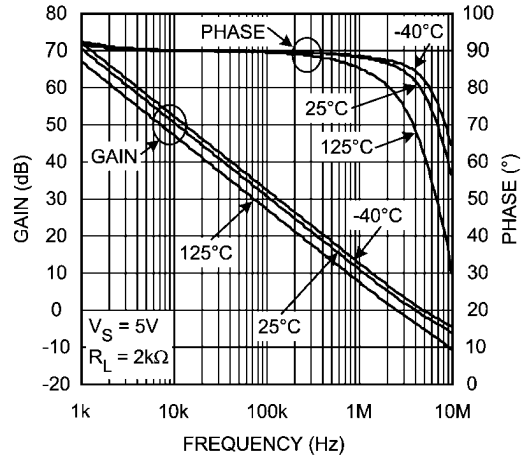

20039602

Open Loop Frequency Response

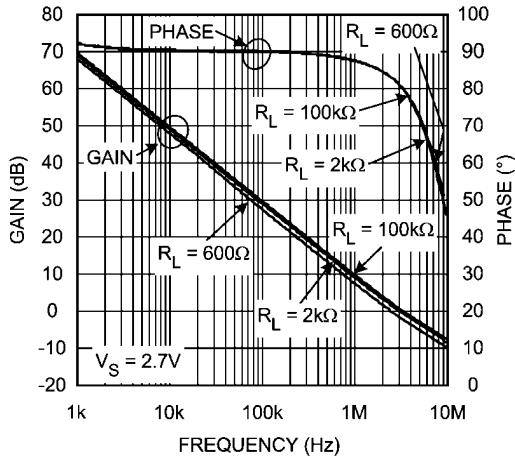

20039603

Open Loop Frequency Response

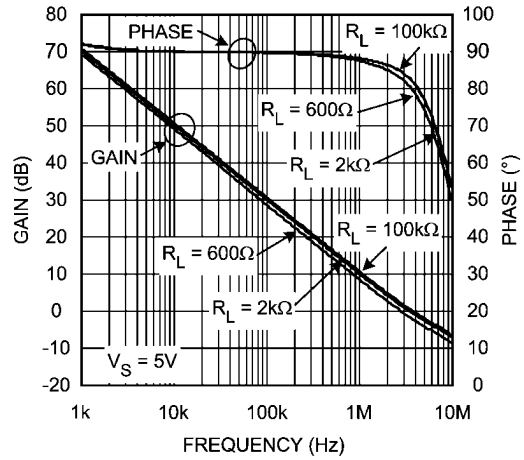

20039604

Open Loop Gain & Phase with Cap. Loading

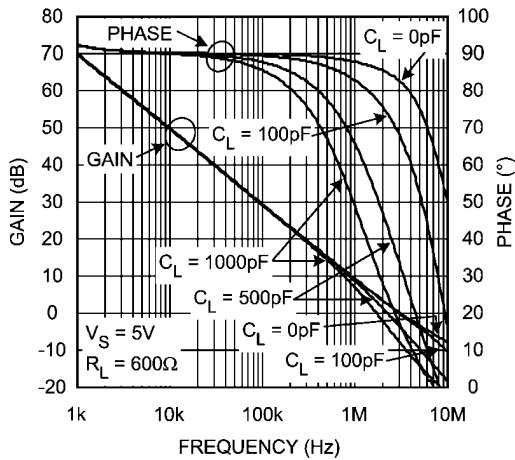

20039605

Open Loop Gain & Phase with Cap. Loading

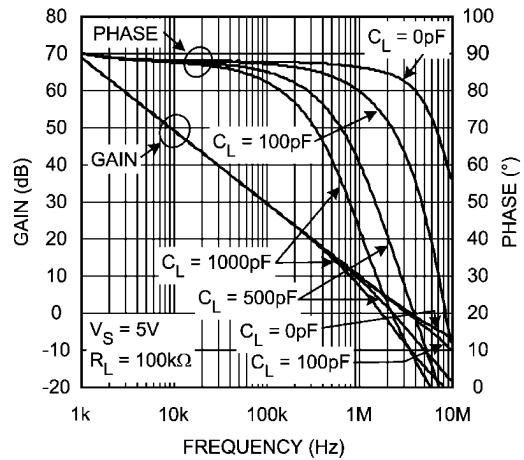

20039606

**Non-Inverting Small Signal Pulse Response**

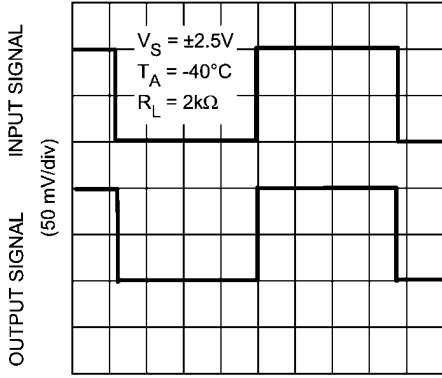

TIME (10  $\mu s$ /div)

20039617

**Non-Inverting Large Signal Pulse Response**

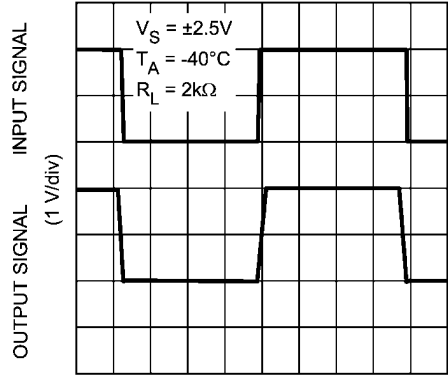

TIME (10  $\mu s$ /div)

20039611

**Non-Inverting Small Signal Pulse Response**

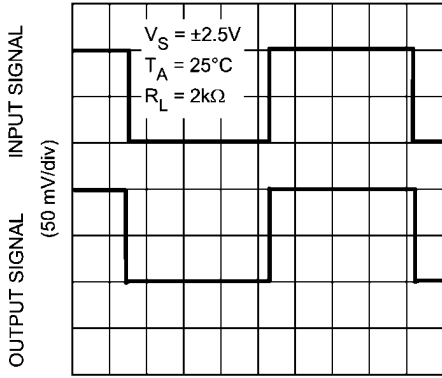

TIME (10  $\mu s$ /div)

20039616

**Non-Inverting Large Signal Pulse Response**

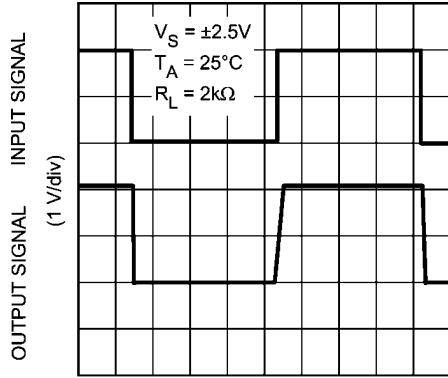

TIME (10  $\mu s$ /div)

20039610

**Non-Inverting Small Signal Pulse Response**

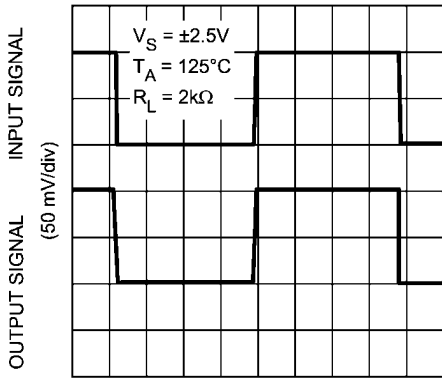

TIME (10  $\mu s$ /div)

20039615

**Non-Inverting Large Signal Pulse Response**

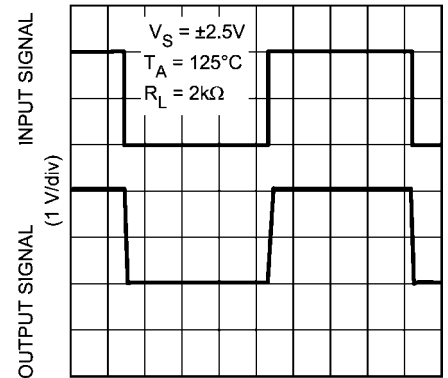

TIME (10  $\mu s$ /div)

20039609

**Inverting Small Signal Pulse Response**

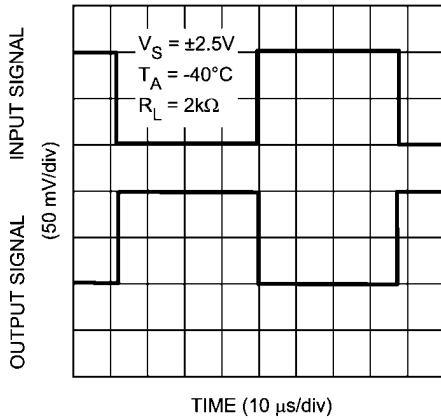

20039619

**Inverting Large Signal Pulse Response**

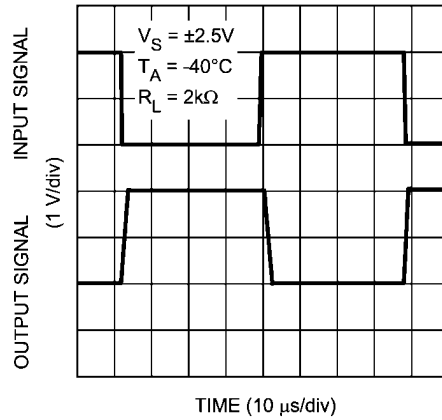

20039614

**Inverting Small Signal Pulse Response**

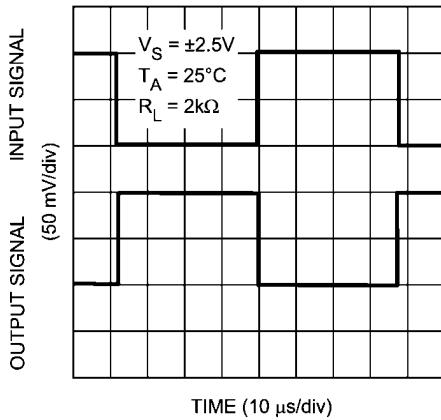

20039620

**Inverting Large Signal Pulse Response**

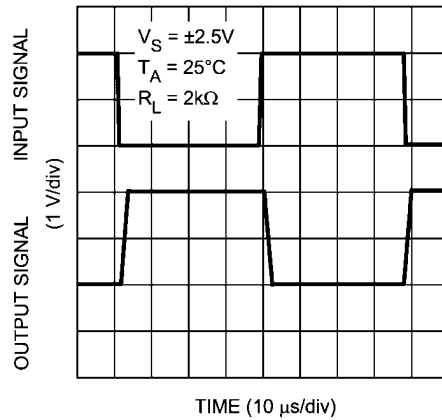

20039613

**Inverting Small Signal Pulse Response**

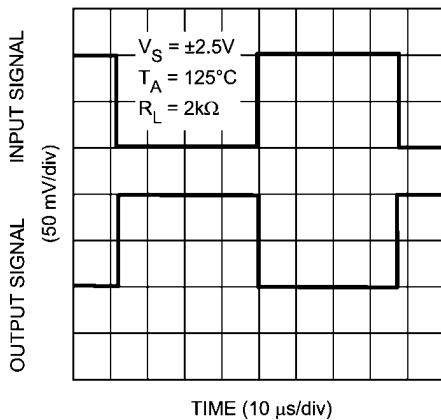

20039618

**Inverting Large Signal Pulse Response**

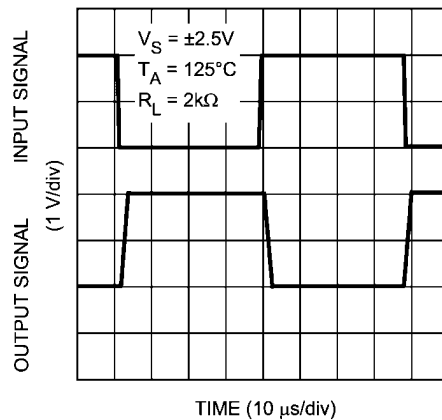

20039612

Stability vs.  $V_{CM}$

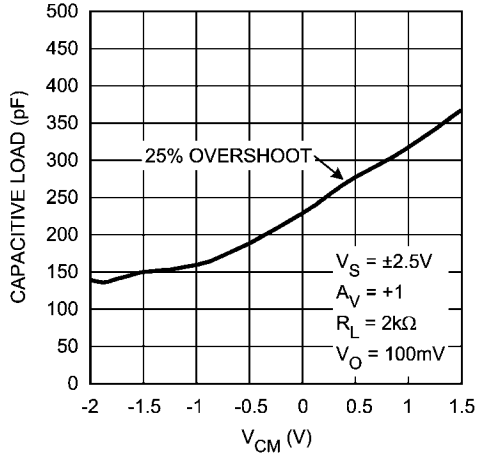

20039621

Stability vs.  $V_{CM}$

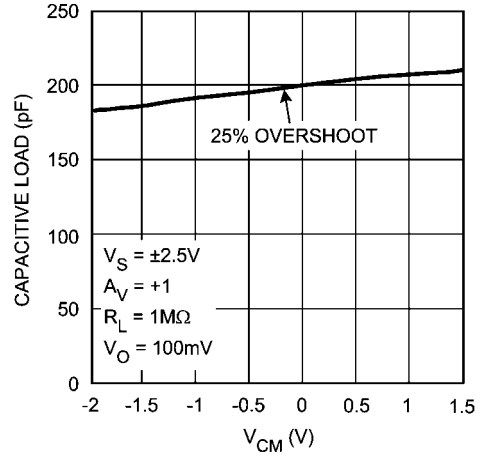

20039622

PSRR vs. Frequency

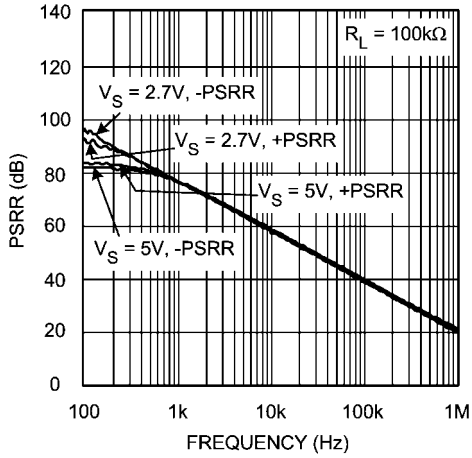

20039668

CMRR vs. Frequency

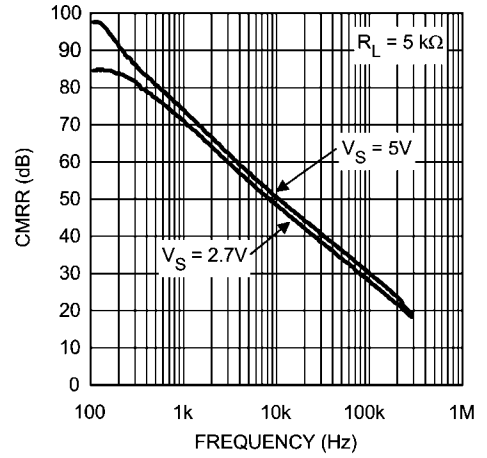

20039665

Crosstalk Rejection vs. Frequency (LMV772/LMV774)

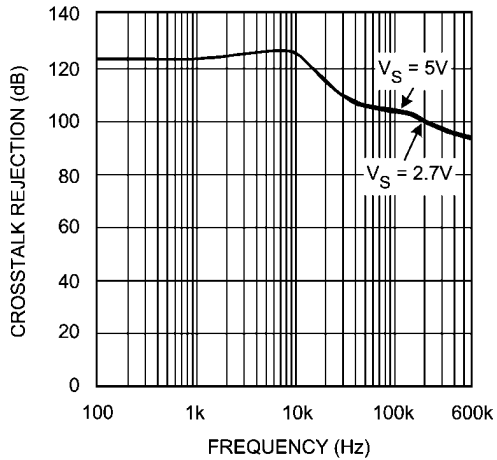

20039694

## Application Note

### LMV771/LMV772/LMV774

The LMV771/LMV772/LMV774 are a family of precision amplifiers with very low noise and ultra low offset voltage. LMV771/LMV772/LMV774's extended temperature range of -40°C to 125°C enables the user to design this family of products into a variety of applications including automotive.

The LMV771 has a maximum offset voltage of 1mV over the extended temperature range. This makes the LMV771 ideal for applications where precision is important.

The LMV772/LMV774 have a maximum offset voltage of 1mV at room temperature and 1.2mV over the extended temperature range of -40°C to 125°C. Care must be taken when the LMV772/LMV774 are designed into applications with heavy loads under extreme temperature conditions. As indicated in the DC tables, the LMV772/LMV774's gain and output swing may be reduced at temperatures between 85°C and 125°C with loads heavier than 2kΩ.

### INSTRUMENTATION AMPLIFIER

Measurement of very small signals with an amplifier requires close attention to the input impedance of the amplifier, gain of the overall signal on the inputs, and the gain on each input since we are only interested in the difference of the two inputs and the common signal is considered noise. A classic solution is an instrumentation amplifier. Instrumentation amplifiers have a finite, accurate, and stable gain. Also they have extremely high input impedances and very low output impedances. Finally they have an extremely high CMRR so that the amplifier can only respond to the differential signal. A typical instrumentation amplifier is shown in *Figure 1*.

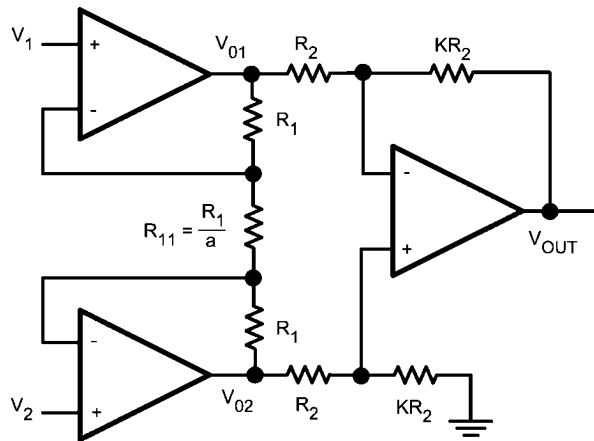

20039636

**FIGURE 1. Instrumentation Amplifier**

There are two stages in this amplifier. The last stage, output stage, is a differential amplifier. In an ideal case the two amplifiers of the first stage, input stage, would be set up as buffers to isolate the inputs. However they cannot be connected as followers because of real amplifier's mismatch. That is why there is a balancing resistor between the two. The product of the two stages of gain will give the gain of the instrumentation amplifier. Ideally, the CMRR should be infinite. However the output stage has a small non-zero common mode gain which results from resistor mismatch.

In the input stage of the circuit, current is the same across all resistors. This is due to the high input impedance and low input bias current of the LMV771. With the node equations we have:

$$\text{GIVEN: } I_{R_1} = I_{R_{11}} \quad (1)$$

By Ohm's Law:

$$\begin{aligned} V_{O1} - V_{O2} &= (2R_1 + R_{11}) I_{R_{11}} \\ &= (2a + 1) R_{11} \cdot I_{R_{11}} \\ &= (2a + 1) V_{R_{11}} \end{aligned} \quad (2)$$

However:

$$V_{R_{11}} = V_1 - V_2 \quad (3)$$

So we have:

$$V_{O1} - V_{O2} = (2a + 1) (V_1 - V_2) \quad (4)$$

Now looking at the output of the instrumentation amplifier:

$$\begin{aligned} V_O &= \frac{KR_2}{R_2} (V_{O2} - V_{O1}) \\ &= -K (V_{O1} - V_{O2}) \end{aligned} \quad (5)$$

Substituting from *Equation 4*:

$$V_O = -K (2a + 1) (V_1 - V_2) \quad (6)$$

This shows the gain of the instrumentation amplifier to be:

$$-K(2a+1)$$

Typical values for this circuit can be obtained by setting: a = 12 and K = 4. This results in an overall gain of -100.

*Figure 2* shows typical CMRR characteristics of this Instrumentation amplifier over frequency. Three LMV771 amplifiers are used along with 1% resistors to minimize resistor mismatch. Resistors used to build the circuit are: R<sub>1</sub> = 21.6kΩ, R<sub>11</sub> = 1.8kΩ, R<sub>2</sub> = 2.5kΩ with K = 40 and a = 12. This results in an overall gain of -1000, -K(2a+1) = -1000.

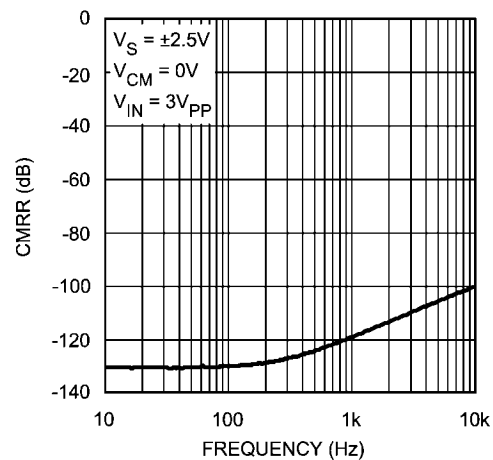

20039673

**FIGURE 2. CMRR vs. Frequency**

**ACTIVE FILTER**

Active filters are circuits with amplifiers, resistors, and capacitors. The use of amplifiers instead of inductors, which are used in passive filters, enhances the circuit performance while reducing the size and complexity of the filter.

The simplest active filters are designed using an inverting op amp configuration where at least one reactive element has been added to the configuration. This means that the op amp will provide "frequency-dependent" amplification, since reactive elements are frequency dependent devices.

**LOW PASS FILTER**

The following shows a very simple low pass filter.

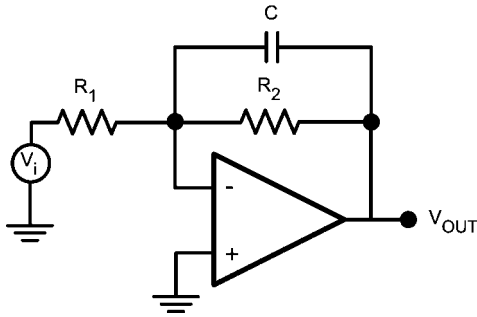

20039647

**FIGURE 3. Lowpass Filter**

The transfer function can be expressed as follows:  
By KCL:

$$\frac{-V_i}{R_1} - \frac{V_O}{\left[\frac{1}{j\omega C}\right]} - \frac{V_O}{R_2} = 0 \tag{7}$$

Simplifying this further results in:

$$V_O = \frac{-R_2}{R_1} \left[ \frac{1}{j\omega C R_2 + 1} \right] V_i \tag{8}$$

or

$$\frac{V_O}{V_i} = \frac{-R_2}{R_1} \left[ \frac{1}{j\omega C R_2 + 1} \right] \tag{9}$$

Now, substituting  $\omega=2\pi f$ , so that the calculations are in f(Hz) and not  $\omega(\text{rad/s})$ , and setting the DC gain  $H_O = -R_2/R_1$  and  $H = V_O/V_i$

$$H = H_O \left[ \frac{1}{j2\pi f C R_2 + 1} \right] \tag{10}$$

Set:  $f_o = 1/(2\pi R_1 C)$

$$H = H_O \left[ \frac{1}{1 + j(f/f_o)} \right] \tag{11}$$

Low pass filters are known as lossy integrators because they only behave as an integrator at higher frequencies. Just by looking at the transfer function one can predict the general form of the bode plot. When the  $f/f_o$  ratio is small, the capacitor is in effect an open circuit and the amplifier behaves at a set DC gain. Starting at  $f_o$ , -3dB corner, the capacitor will have the dominant impedance and hence the circuit will behave as an integrator and the signal will be attenuated and eventually cut. The bode plot for this filter is shown in the following picture:

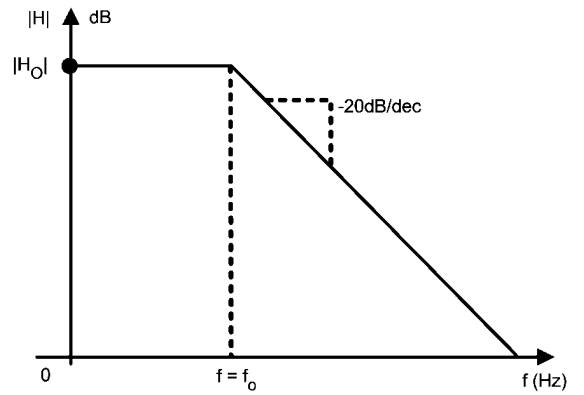

20039653

**FIGURE 4. Lowpass Filter Transfer Function**

**HIGH PASS FILTER**

In a similar approach, one can derive the transfer function of a high pass filter. A typical first order high pass filter is shown below:

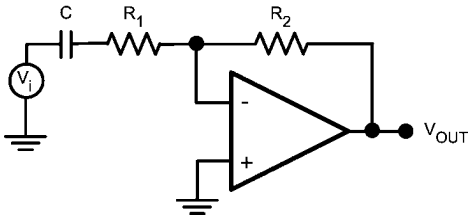

20039654

**FIGURE 5. Highpass Filter**

Writing the KCL for this circuit :

( $V_1$  denotes the voltage between C and  $R_1$ )

$$\frac{V_1 - V_i}{\frac{1}{j\omega C}} = \frac{V_1 - V^-}{R_1} \tag{12}$$

$$\frac{V^- + V_1}{R_1} = \frac{V^- + V_O}{R_2} \tag{13}$$

Solving these two equations to find the transfer function and using:

$$f_o = \frac{1}{2\pi R_1 C}$$

(high frequency gain)  $H_O = \frac{-R_2}{R_1}$  and  $H = \frac{V_O}{V_i}$

Which results:

$$H = H_O \frac{j(f/f_o)}{1 + j(f/f_o)} \tag{14}$$

Looking at the transfer function, it is clear that when  $f/f_o$  is small, the capacitor is open and hence no signal is getting in to the amplifier. As the frequency increases the amplifier starts operating. At  $f = f_o$  the capacitor behaves like a short circuit and the amplifier will have a constant, high frequency, gain of  $H_O$ . *Figure 6* shows the transfer function of this high pass filter:

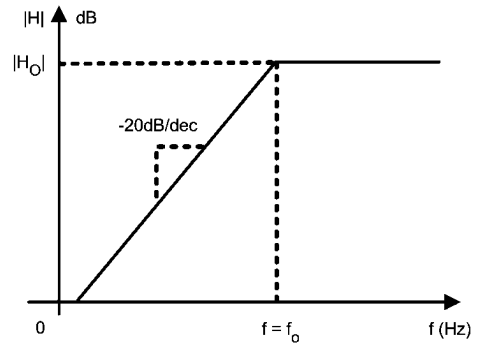

20039658

**FIGURE 6. Highpass Filter Transfer Function**

**BAND PASS FILTER**

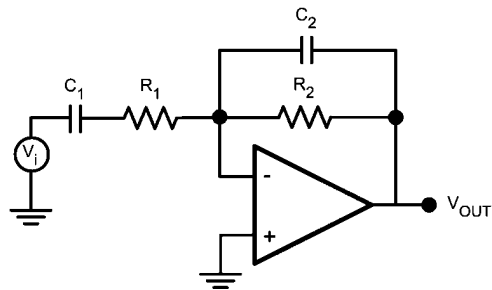

20039660

**FIGURE 7. Bandpass Filter**

Combining a low pass filter and a high pass filter will generate a band pass filter. In this network the input impedance forms the high pass filter while the feedback impedance forms the low pass filter. Choosing the corner frequencies so that  $f_1 < f_2$ , then all the frequencies in between,  $f_1 \leq f \leq f_2$ , will pass through the filter while frequencies below  $f_1$  and above  $f_2$  will be cut off.

The transfer function can be easily calculated using the same methodology as before.

$$H = H_O \frac{j(f/f_1)}{[1 + j(f/f_1)] [1 + j(f/f_2)]} \tag{15}$$

Where

$$f_1 = \frac{1}{2\pi R_1 C_1}$$

$$f_2 = \frac{1}{2\pi R_2 C_2}$$

$$H_O = \frac{-R_2}{R_1}$$

The transfer function is presented in the following figure.

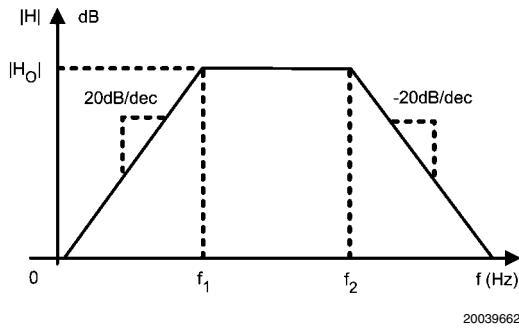

FIGURE 8. Bandpass filter Transfer Function

**STATE VARIABLE ACTIVE FILTER**

State variable active filters are circuits that can simultaneously represent high pass, band pass, and low pass filters. The state variable active filter uses three separate amplifiers to achieve this task. A typical state variable active filter is shown in Figure 9. The first amplifier in the circuit is connected as a gain stage. The second and third amplifiers are connected as integrators, which means they behave as low pass filters. The feedback path from the output of the third amplifier to the first amplifier enables this low frequency signal to be fed back with a finite and fairly low closed loop gain. This is while the high frequency signal on the input is still gained up by the open loop gain of the 1st amplifier. This makes the first amplifier a high pass filter. The high pass signal is then fed into a low pass filter. The outcome is a band pass signal, meaning the second amplifier is a band pass filter. This signal is then fed into the third amplifiers input and so, the third amplifier behaves as a simple low pass filter.

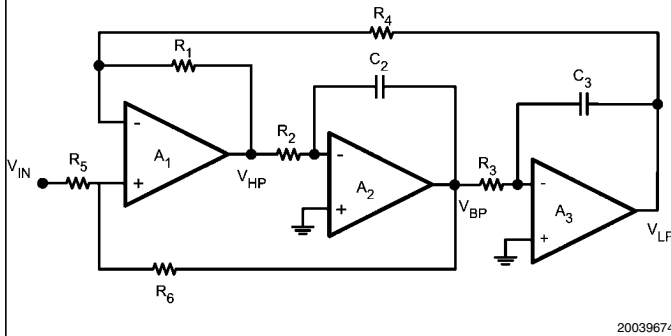
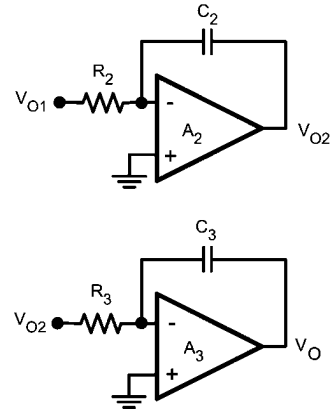
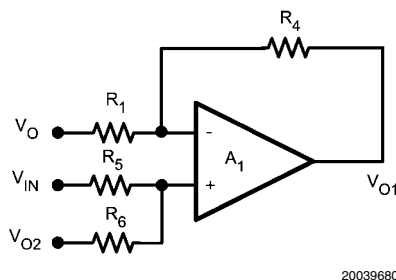

FIGURE 9. State Variable Active Filter

The transfer function of each filter needs to be calculated. The derivations will be more trivial if each stage of the filter is shown on its own.

The three components are:



For A<sub>1</sub> the relationship between input and output is:

$$V_{O1} = \frac{-R_4}{R_1} V_0 + \left[ \frac{R_6}{R_5 + R_6} \right] \left[ \frac{R_1 + R_4}{R_1} \right] V_{IN} + \left[ \frac{R_5}{R_5 + R_6} \right] \left[ \frac{R_1 + R_4}{R_1} \right] V_{O2}$$

This relationship depends on the output of all the filters. The input-output relationship for A<sub>2</sub> can be expressed as:

$$V_{O2} = \frac{-1}{s C_2 R_2} V_{O1}$$

And finally this relationship for A<sub>3</sub> is as follows:

$$V_0 = \frac{-1}{s C_3 R_3} V_{O2}$$

Re-arranging these equations, one can find the relationship between V<sub>0</sub> and V<sub>IN</sub> (transfer function of the lowpass filter), V<sub>O1</sub> and V<sub>IN</sub> (transfer function of the highpass filter), and V<sub>O2</sub> and V<sub>IN</sub> (transfer function of the bandpass filter) These relationships are as follows:

**Lowpass Filter**

$$\frac{V_0}{V_{IN}} = \frac{\left[ \frac{R_1 + R_4}{R_1} \right] \left[ \frac{R_6}{R_5 + R_6} \right] \left[ \frac{1}{C_2 C_3 R_2 R_3} \right]}{s^2 + s \left[ \frac{1}{C_2 R_2} \right] \left[ \frac{R_5}{R_5 + R_6} \right] \left[ \frac{R_1 + R_4}{R_1} \right] + \left[ \frac{1}{C_2 C_3 R_2 R_3} \right]}$$

**Highpass Filter**

$$\frac{V_{O1}}{V_{IN}} = \frac{s^2 \left[ \frac{R_1 + R_4}{R_1} \right] \left[ \frac{R_6}{R_5 + R_6} \right]}{s^2 + s \left[ \frac{1}{C_2 R_2} \right] \left[ \frac{R_5}{R_5 + R_6} \right] \left[ \frac{R_1 + R_4}{R_1} \right] + \left[ \frac{1}{C_2 C_3 R_2 R_3} \right]}$$

**Bandpass Filter**

$$\frac{V_{O2}}{V_{IN}} = \frac{s \left[ \frac{1}{C_2 R_2} \right] \left[ \frac{R_1 + R_4}{R_1} \right] \left[ \frac{R_6}{R_5 + R_6} \right]}{s^2 + s \left[ \frac{1}{C_2 R_2} \right] \left[ \frac{R_5 + R_6}{R_5 + R_6} \right] \left[ \frac{R_1 + R_4}{R_1} \right] + \left[ \frac{1}{C_2 C_3 R_2 R_3} \right]}$$

The center frequency and Quality Factor for all of these filters is the same. The values can be calculated in the following manner:

$$\omega_c = \sqrt{\frac{1}{C_2 C_3 R_2 R_3}}$$

and

$$Q = \sqrt{\frac{C_2 R_2}{C_3 R_3} \left[ \frac{R_5 + R_6}{R_6} \right] \left[ \frac{R_1}{R_1 + R_4} \right]}$$

A design example is shown here:

Designing a bandpass filter with center frequency of 10kHz and Quality Factor of 5.5

To do this, first consider the Quality Factor. It is best to pick convenient values for the capacitors.  $C_2 = C_3 = 1000\text{pF}$ . Also, choose  $R_1 = R_4 = 30\text{k}\Omega$ . Now values of  $R_5$  and  $R_6$  need to be calculated. With the chosen values for the capacitors and resistors, Q reduces to:

$$Q = \frac{11}{2} = \frac{1}{2} \left[ \frac{R_5 + R_6}{R_6} \right]$$

or

$$\begin{aligned} R_5 &= 10R_6 \\ R_6 &= 1.5\text{k}\Omega \\ R_5 &= 15\text{k}\Omega \end{aligned}$$

Also, for  $f = 10\text{kHz}$ , the center frequency is  $\omega_c = 2\pi f = 62.8\text{kHz}$ .

Using the expressions above, the appropriate resistor values will be  $R_2 = R_3 = 16\text{k}\Omega$ .

The following graphs show the transfer function of each of the filters. The DC gain of this circuit is:

$$\text{DC GAIN} = \left[ \frac{R_1 + R_4}{R_1} \right] \left[ \frac{R_6}{R_5 + R_6} \right] = -14.8 \text{ dB}$$

20039690

The frequency responses of each stage of the state variable active filter when implemented with the LMV774 are shown in the following figures:

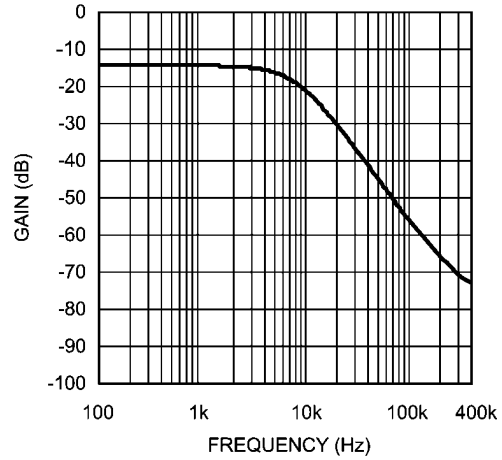

20039691

**FIGURE 10. Lowpass Filter Frequency Response**

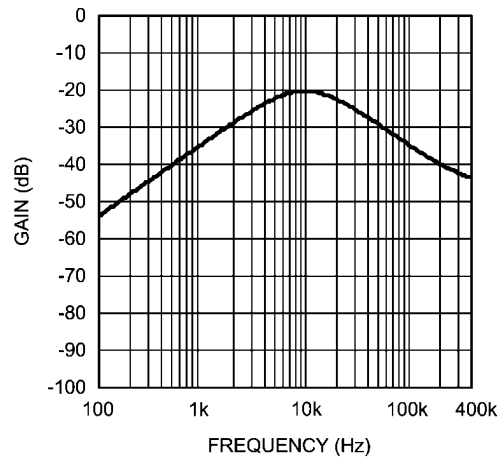

20039692

**FIGURE 11. Bandpass Filter Frequency Response**

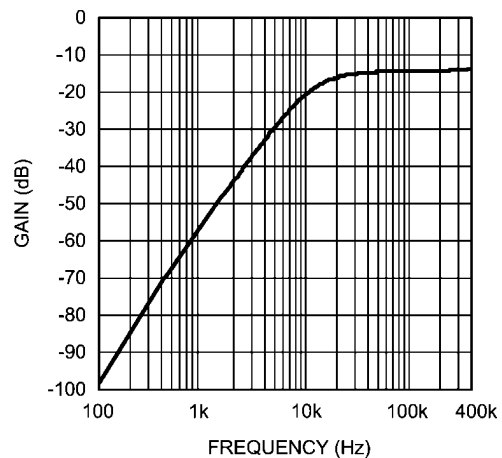

20039693

**FIGURE 12. Highpass Filter Frequency Response**

**Physical Dimensions** inches (millimeters) unless otherwise noted

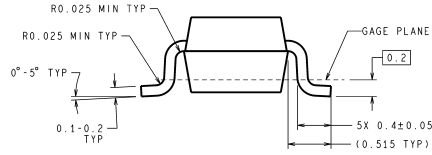
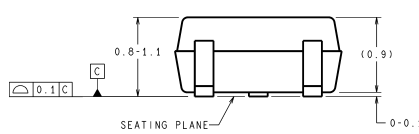
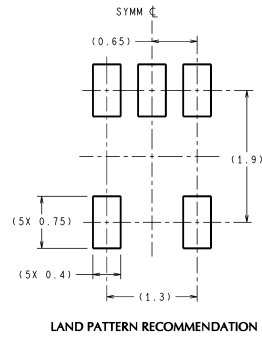
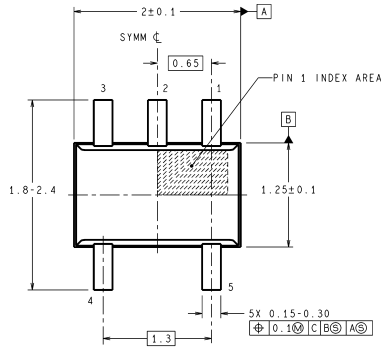

DIMENSIONS ARE IN MILLIMETERS  
DIMENSIONS IN ( ) FOR REFERENCE ONLY

MAA05A (Rev D)

**SC70-5**  
**NS Package Number MAA05A**

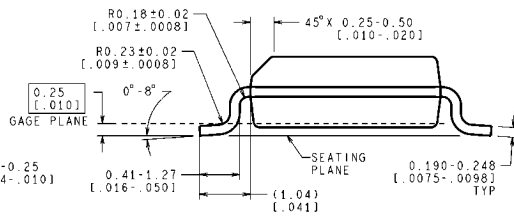
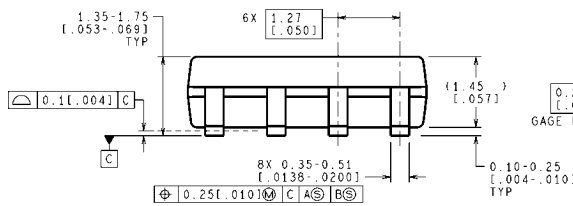
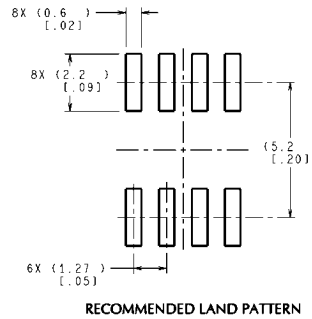
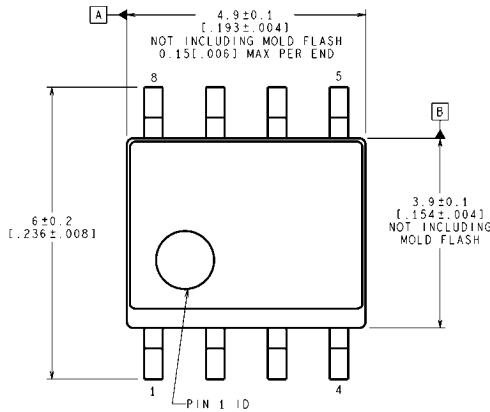

CONTROLLING DIMENSION IS MILLIMETER  
VALUES IN [ ] ARE INCHES  
DIMENSIONS IN ( ) FOR REFERENCE ONLY

M08A (Rev L)

**8-Pin SOIC**  
**NS Package Number M08A**

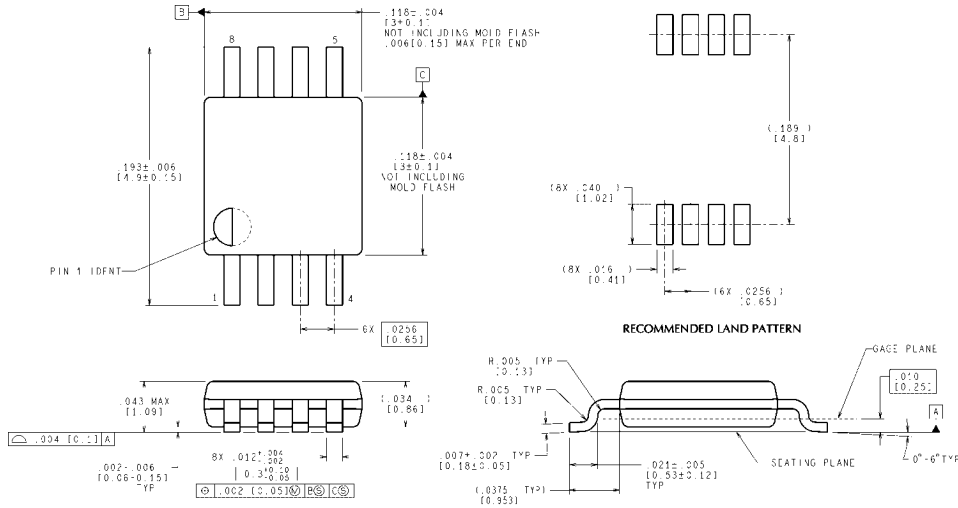

CONTROLLING DIMENSION IS INCH  
VALUES IN [ ] ARE MILLIMETERS

MUA08A (Rev F)

**8-Pin MSOP  
NS Package Number MUA08A**

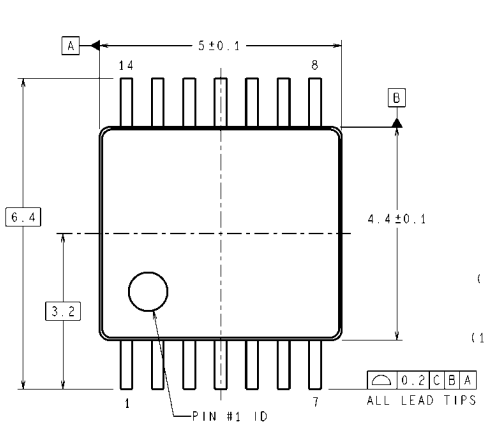

DIMENSIONS ARE IN MILLIMETERS  
DIMENSIONS IN ( ) FOR REFERENCE ONLY

MTC14 (Rev D)

**14-Pin TSSOP  
NS Package Number MTC14**

## Notes

For more National Semiconductor product information and proven design tools, visit the following Web sites at:

Products		Design Support	
Amplifiers	<a href="http://www.national.com/amplifiers">www.national.com/amplifiers</a>	WEBENCH	<a href="http://www.national.com/webench">www.national.com/webench</a>
Audio	<a href="http://www.national.com/audio">www.national.com/audio</a>	Analog University	<a href="http://www.national.com/AU">www.national.com/AU</a>
Clock Conditioners	<a href="http://www.national.com/timing">www.national.com/timing</a>	App Notes	<a href="http://www.national.com/appnotes">www.national.com/appnotes</a>
Data Converters	<a href="http://www.national.com/adc">www.national.com/adc</a>	Distributors	<a href="http://www.national.com/contacts">www.national.com/contacts</a>
Displays	<a href="http://www.national.com/displays">www.national.com/displays</a>	Green Compliance	<a href="http://www.national.com/quality/green">www.national.com/quality/green</a>
Ethernet	<a href="http://www.national.com/ethernet">www.national.com/ethernet</a>	Packaging	<a href="http://www.national.com/packaging">www.national.com/packaging</a>
Interface	<a href="http://www.national.com/interface">www.national.com/interface</a>	Quality and Reliability	<a href="http://www.national.com/quality">www.national.com/quality</a>
LVDS	<a href="http://www.national.com/lvds">www.national.com/lvds</a>	Reference Designs	<a href="http://www.national.com/refdesigns">www.national.com/refdesigns</a>
Power Management	<a href="http://www.national.com/power">www.national.com/power</a>	Feedback	<a href="http://www.national.com/feedback">www.national.com/feedback</a>
Switching Regulators	<a href="http://www.national.com/switchers">www.national.com/switchers</a>		
LDOs	<a href="http://www.national.com/lido">www.national.com/lido</a>		
LED Lighting	<a href="http://www.national.com/led">www.national.com/led</a>		
PowerWise	<a href="http://www.national.com/powerwise">www.national.com/powerwise</a>		
Serial Digital Interface (SDI)	<a href="http://www.national.com/sdi">www.national.com/sdi</a>		
Temperature Sensors	<a href="http://www.national.com/tempsensors">www.national.com/tempsensors</a>		
Wireless (PLL/VCO)	<a href="http://www.national.com/wireless">www.national.com/wireless</a>		

THE CONTENTS OF THIS DOCUMENT ARE PROVIDED IN CONNECTION WITH NATIONAL SEMICONDUCTOR CORPORATION ("NATIONAL") PRODUCTS. NATIONAL MAKES NO REPRESENTATIONS OR WARRANTIES WITH RESPECT TO THE ACCURACY OR COMPLETENESS OF THE CONTENTS OF THIS PUBLICATION AND RESERVES THE RIGHT TO MAKE CHANGES TO SPECIFICATIONS AND PRODUCT DESCRIPTIONS AT ANY TIME WITHOUT NOTICE. NO LICENSE, WHETHER EXPRESS, IMPLIED, ARISING BY ESTOPPEL OR OTHERWISE, TO ANY INTELLECTUAL PROPERTY RIGHTS IS GRANTED BY THIS DOCUMENT.

TESTING AND OTHER QUALITY CONTROLS ARE USED TO THE EXTENT NATIONAL DEEMS NECESSARY TO SUPPORT NATIONAL'S PRODUCT WARRANTY. EXCEPT WHERE MANDATED BY GOVERNMENT REQUIREMENTS, TESTING OF ALL PARAMETERS OF EACH PRODUCT IS NOT NECESSARILY PERFORMED. NATIONAL ASSUMES NO LIABILITY FOR APPLICATIONS ASSISTANCE OR BUYER PRODUCT DESIGN. BUYERS ARE RESPONSIBLE FOR THEIR PRODUCTS AND APPLICATIONS USING NATIONAL COMPONENTS. PRIOR TO USING OR DISTRIBUTING ANY PRODUCTS THAT INCLUDE NATIONAL COMPONENTS, BUYERS SHOULD PROVIDE ADEQUATE DESIGN, TESTING AND OPERATING SAFEGUARDS.

EXCEPT AS PROVIDED IN NATIONAL'S TERMS AND CONDITIONS OF SALE FOR SUCH PRODUCTS, NATIONAL ASSUMES NO LIABILITY WHATSOEVER, AND NATIONAL DISCLAIMS ANY EXPRESS OR IMPLIED WARRANTY RELATING TO THE SALE AND/OR USE OF NATIONAL PRODUCTS INCLUDING LIABILITY OR WARRANTIES RELATING TO FITNESS FOR A PARTICULAR PURPOSE, MERCHANTABILITY, OR INFRINGEMENT OF ANY PATENT, COPYRIGHT OR OTHER INTELLECTUAL PROPERTY RIGHT.

### LIFE SUPPORT POLICY

**NATIONAL'S PRODUCTS ARE NOT AUTHORIZED FOR USE AS CRITICAL COMPONENTS IN LIFE SUPPORT DEVICES OR SYSTEMS WITHOUT THE EXPRESS PRIOR WRITTEN APPROVAL OF THE CHIEF EXECUTIVE OFFICER AND GENERAL COUNSEL OF NATIONAL SEMICONDUCTOR CORPORATION.** As used herein:

Life support devices or systems are devices which (a) are intended for surgical implant into the body, or (b) support or sustain life and whose failure to perform when properly used in accordance with instructions for use provided in the labeling can be reasonably expected to result in a significant injury to the user. A critical component is any component in a life support device or system whose failure to perform can be reasonably expected to cause the failure of the life support device or system or to affect its safety or effectiveness.

National Semiconductor and the National Semiconductor logo are registered trademarks of National Semiconductor Corporation. All other brand or product names may be trademarks or registered trademarks of their respective holders.

Copyright© 2008 National Semiconductor Corporation

For the most current product information visit us at [www.national.com](http://www.national.com)



**National Semiconductor Americas Technical Support Center**  
Email: [support@nsc.com](mailto:support@nsc.com)  
Tel: 1-800-272-9959

**National Semiconductor Europe Technical Support Center**  
Email: [europe.support@nsc.com](mailto:europe.support@nsc.com)  
German Tel: +49 (0) 180 5010 771  
English Tel: +44 (0) 870 850 4288

**National Semiconductor Asia Pacific Technical Support Center**  
Email: [ap.support@nsc.com](mailto:ap.support@nsc.com)

**National Semiconductor Japan Technical Support Center**  
Email: [jpn.feedback@nsc.com](mailto:jpn.feedback@nsc.com)