

LMH6640 TFT-LCD Single, 16V Rail-to-Rail High Output Operational Amplifier

Check for Samples: [LMH6640](#)

FEATURES

- ($V_S = 16V$, $R_L = 2\text{ k}\Omega$ to $V^+/2$, 25°C , Typical Values Unless Specified)
- Supply current (no load) 4 mA
- Output resistance (closed loop 1 MHz) 0.35 Ω
- -3 dB BW ($A_V = 1$) 190 MHz
- Settling time ($\pm 0.1\%$, $2 V_{PP}$) 35 ns
- Input common mode voltage -0.3V to 15.1V
- Output voltage swing 100 mV from rails
- Linear output current $\pm 100\text{ mA}$
- Total harmonic distortion ($2 V_{PP}$, 5 MHz) -64 dBc
- Fully characterized for: 5V & 16V
- No output phase reversal with CMVR exceeded
- Differential gain ($R_L = 150\Omega$) 0.12%
- Differential phase ($R_L = 150\Omega$) 0.12°

APPLICATIONS

- TFT panel V_{COM} buffer amplifier
- Active filters
- CD/DVD ROM
- ADC buffer amplifier
- Portable video
- Current sense buffer

DESCRIPTION

The LMH™6640 is a voltage feedback operational amplifier with a rail-to-rail output drive capability of 100 mA. Employing TI's patented VIP10 process, the LMH6640 delivers a bandwidth of 190 MHz at a current consumption of only 4mA. An input common mode voltage range extending to 0.3V below the V^- and to within 0.9V of V^+ , makes the LMH6640 a true single supply op-amp. The output voltage range extends to within 100 mV of either supply rail providing the user with a dynamic range that is especially desirable in low voltage applications.

The LMH6640 offers a slew rate of 170 V/ μs resulting in a full power bandwidth of approximately 28 MHz with 5V single supply ($2 V_{PP}$, -1 dB). Careful attention has been paid to ensure device stability under all operating voltages and modes. The result is a very well behaved frequency response characteristic for any gain setting including +1, and excellent specifications for driving video cables including total harmonic distortion of -64 dBc @ 5 MHz, differential gain of 0.12% and differential phase of 0.12°.

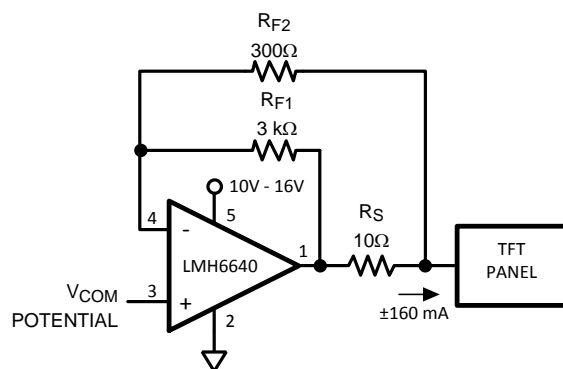

Figure 1. Typical Application as a TFT Panel V_{COM} Driver



Please be aware that an important notice concerning availability, standard warranty, and use in critical applications of Texas Instruments semiconductor products and disclaimers thereto appears at the end of this data sheet.

LMH is a trademark of Texas Instruments.

All other trademarks are the property of their respective owners.



These devices have limited built-in ESD protection. The leads should be shorted together or the device placed in conductive foam during storage or handling to prevent electrostatic damage to the MOS gates.

Absolute Maximum Ratings ⁽¹⁾

ESD Tolerance ⁽²⁾	
Human Body Model	2 KV
Machine Model	200V
V _{IN} Differential	±2.5V
Input Current	±10 mA
Supply Voltages (V ⁺ – V ⁻)	18V
Voltage at Input/Output Pins	V ⁺ +0.8V, V ⁻ -0.8V
Storage Temperature Range	-65°C to +150°C
Junction Temperature ⁽³⁾	+150°C
Soldering Information	
Infrared or Convection (20 sec.)	235°C
Wave Soldering (10 sec.)	260°C

- (1) Absolute maximum Ratings indicate limits beyond which damage to the device may occur. Operating Ratings indicate conditions for which the device is intended to be functional, but specific performance is not ensured. For specifications and the test conditions, see the Electrical Characteristics.
- (2) Human body model, 1.5 kΩ in series with 100 pF. Machine Model, 0Ω in series with 200 pF.
- (3) The maximum power dissipation is a function of T_{J(MAX)}, θ_{JA}, and T_A. The maximum allowable power dissipation at any ambient temperature is P_D = (T_{J(MAX)} - T_A) / θ_{JA}. All numbers apply for packages soldered directly onto a PC board.

Operating Ratings ⁽¹⁾

Supply Voltage (V ⁺ – V ⁻)	4.5V to 16V
Operating Temperature Range ⁽²⁾	-40°C to +85°C
Package Thermal Resistance ⁽²⁾	
5-Pin SOT-23	265°C/W

- (1) Applies to both single-supply and split-supply operation. Continuous short circuit operation at elevated ambient temperature can result in exceeding the maximum allowed junction temperature of 150 °C Short circuit test is a momentary test. Output short circuit duration is infinite for V_S < 6V at room temperature and below. For V_S > 6V, allowable short circuit duration is 1.5 ms.
- (2) The maximum power dissipation is a function of T_{J(MAX)}, θ_{JA}, and T_A. The maximum allowable power dissipation at any ambient temperature is P_D = (T_{J(MAX)} - T_A) / θ_{JA}. All numbers apply for packages soldered directly onto a PC board.

5V Electrical Characteristics

Unless otherwise specified, All limits specified for $T_J = 25^\circ\text{C}$, $V^+ = 5\text{V}$, $V^- = 0\text{V}$, $V_O = V_{\text{CM}} = V^+/2$ and $R_L = 2\text{ k}\Omega$ to $V^+/2$.

Boldface limits apply at temperature extremes. ⁽¹⁾

Symbol	Parameter	Conditions	Min ⁽²⁾	Typ ⁽³⁾	Max ⁽²⁾	Units
BW	-3 dB Bandwidth	$A_V = +1$ ($R_L = 100\Omega$)		150		MHz
		$A_V = -1$ ($R_L = 100\Omega$)		58		
$BW_{0.1\text{ dB}}$	0.1 dB Gain Flatness	$A_V = -3$		18		MHz
FPBW	Full Power Bandwidth	$A_V = +1$, $V_{\text{OUT}} = 2 V_{\text{PP}}$, -1 dB		28		MHz
LSBW	-3 dB Bandwidth	$A_V = +1$, $V_O = 2 V_{\text{PP}}$ ($R_L = 100\Omega$)		32		MHz
GBW	Gain Bandwidth Product	$A_V = +1$, ($R_L = 100\Omega$)		59		MHz
SR	Slew Rate ⁽⁴⁾	$A_V = -1$		170		V/ μs
e_n	Input Referred Voltage Noise		f = 10 kHz	23		nV/ $\sqrt{\text{Hz}}$
			f = 1 MHz	15		
i_n	Input Referred Current Noise		f = 10 kHz	1.1		pA/ $\sqrt{\text{Hz}}$
			f = 1 MHz	0.7		
THD	Total Harmonic Distortion	f = 5 MHz, $V_O = 2 V_{\text{PP}}$, $A_V = +2$ $R_L = 1\text{ k}\Omega$ to $V^+/2$		-65		dBc
t_s	Settling Time	$V_O = 2 V_{\text{PP}}$, $\pm 0.1\%$, $A_V = -1$		35		ns
V_{OS}	Input Offset Voltage			1	5 7	mV
I_B	Input Bias Current ⁽⁵⁾			-1.2	-2.6 -3.25	μA
I_{OS}	Input Offset Current			34	800 1400	nA
CMVR	Common Mode Input Voltage Range	CMRR $\geq 50\text{ dB}$		-0.3	-0.2 -0.1	V
			4.0 3.6	4.1		
CMRR	Common Mode Rejection Ratio	$V^- \leq V_{\text{CM}} \leq V^+ - 1.5\text{V}$	72	90		dB
A_{VOL}	Large Signal Voltage Gain	$V_O = 4 V_{\text{PP}}$, $R_L = 2\text{ k}\Omega$ to $V^+/2$	86 82	95		dB
		$V_O = 3.75 V_{\text{PP}}$, $R_L = 150\Omega$ to $V^+/2$	74 70	78		
V_O	Output Swing High	$R_L = 2\text{ k}\Omega$ to $V^+/2$	4.90	4.94		V
		$R_L = 150\Omega$ to $V^+/2$	4.75	4.80		
	Output Swing Low	$R_L = 2\text{ k}\Omega$ to $V^+/2$		0.06	0.10	
		$R_L = 150\Omega$ to $V^+/2$		0.20	0.25	
I_{SC}	Output Short Circuit Current ⁽⁶⁾	Sourcing to $V^+/2$	100 75	130		mA
		Sinking from $V^+/2$	100 70	130		
I_{OUT}	Output Current	$V_O = 0.5\text{V}$ from either Supply		+75/-90		mA
PSRR	Power Supply Rejection Ratio	$4\text{V} \leq V^+ \leq 6\text{V}$	72	80		dB
I_S	Supply Current	No Load		3.7	5.5 8.0	mA
R_{IN}	Common Mode Input Resistance	$A_V = +1$, f = 1 kHz, $R_S = 1\text{ M}\Omega$		15		$\text{M}\Omega$

(1) Electrical Table values apply only for factory testing conditions at the temperature indicated. Factory testing conditions result in very limited self-heating of the device such that $T_J = T_A$. Parametric performance is indicated in the electrical tables under conditions of internal self-heating where $T_J > T_A$.

(2) All limits are specified by testing or statistical analysis.

(3) Typical Values represent the most likely parametric norm.

(4) Slew rate is the average of the rising and falling slew rates

(5) Positive current corresponds to current flowing into the device.

(6) Applies to both single-supply and split-supply operation. Continuous short circuit operation at elevated ambient temperature can result in exceeding the maximum allowed junction temperature of 150°C . Short circuit test is a momentary test. Output short circuit duration is infinite for $V_S < 6\text{V}$ at room temperature and below. For $V_S > 6\text{V}$, allowable short circuit duration is 1.5 ms.

5V Electrical Characteristics (continued)

Unless otherwise specified, All limits specified for $T_J = 25^\circ\text{C}$, $V^+ = 5\text{V}$, $V^- = 0\text{V}$, $V_O = V_{\text{CM}} = V^+/2$ and $R_L = 2\text{ k}\Omega$ to $V^+/2$.

Boldface limits apply at temperature extremes. ⁽¹⁾

Symbol	Parameter	Conditions	Min ⁽²⁾	Typ ⁽³⁾	Max ⁽²⁾	Units
C_{IN}	Common Mode Input Capacitance	$A_V = +1$, $R_S = 100\text{ k}\Omega$		1.7		pF
R_{OUT}	Output Resistance Closed Loop	$R_F = 10\text{ k}\Omega$, $f = 1\text{ kHz}$, $A_V = -1$		0.1		Ω
		$R_F = 10\text{ k}\Omega$, $f = 1\text{ MHz}$, $A_V = -1$		0.4		
DG	Differential Gain	NTSC, $A_V = +2$ $R_L = 150\Omega$ to $V^+/2$		0.13		%
DP	Differential Phase	NTSC, $A_V = +2$ $R_L = 150\Omega$ to $V^+/2$		0.10		deg

16V Electrical Characteristics

Unless otherwise specified, All limits specified for $T_J = 25^\circ\text{C}$, $V^+ = 16\text{V}$, $V^- = 0\text{V}$, $V_O = V_{CM} = V^+/2$ and $R_L = 2\text{ k}\Omega$ to $V^+/2$.

Boldface limits apply at temperature extremes. ⁽¹⁾

Symbol	Parameter	Conditions	Min ⁽²⁾	Typ ⁽³⁾	Max ⁽²⁾	Units
BW	-3 dB Bandwidth	$A_V = +1$ ($R_L = 100\Omega$)		190		MHz
		$A_V = -1$ ($R_L = 100\Omega$)		60		
BW _{0.1 dB}	0.1 dB Gain Flatness	$A_V = -2.7$		20		MHz
LSBW	-3 dB Bandwidth	$A_V = +1$, $V_O = 2 V_{PP}$ ($R_L = 100\Omega$)		35		MHz
GBW	Gain Bandwidth Product	$A_V = +1$, ($R_L = 100\Omega$)		62		MHz
SR	Slew Rate ⁽⁴⁾	$A_V = -1$		170		V/ μs
e_n	Input Referred Voltage Noise		f = 10 kHz	23		nV/ $\sqrt{\text{Hz}}$
			f = 1 MHz	15		
i_n	Input Referred Current Noise		f = 10 kHz	1.1		pA/ $\sqrt{\text{Hz}}$
			f = 1 MHz	0.7		
THD	Total Harmonic Distortion	f = 5 MHz, $V_O = 2 V_{PP}$, $A_V = +2$ $R_L = 1\text{ k}\Omega$ to $V^+/2$		-64		dBc
t_s	Settling Time	$V_O = 2 V_{PP}$, $\pm 0.1\%$, $A_V = -1$		35		ns
V_{OS}	Input Offset Voltage			1	5 7	mV
I_B	Input Bias Current ⁽⁵⁾			-1	-2.6 -3.5	μA
I_{OS}	Input Offset Current			34	800 1800	nA
CMVR	Common Mode Input Voltage Range	CMRR $\geq 50\text{ dB}$		-0.3	-0.2 -0.1	V
			15.0 14.6	15.1		
CMRR	Common Mode Rejection Ratio	$V^- \leq V_{CM} \leq V^+ - 1.5\text{V}$	72	90		dB
A_{VOL}	Large Signal Voltage Gain	$V_O = 15 V_{PP}$, $R_L = 2\text{ k}\Omega$ to $V^+/2$	86 82	95		dB
		$V_O = 14 V_{PP}$, $R_L = 150\Omega$ to $V^+/2$	74 70	78		
V_O	Output Swing High	$R_L = 2\text{ k}\Omega$ to $V^+/2$	15.85	15.90		V
		$R_L = 150\Omega$ to $V^+/2$	15.45	15.78		
	Output Swing Low	$R_L = 2\text{ k}\Omega$ to $V^+/2$		0.10	0.15	
		$R_L = 150\Omega$ to $V^+/2$		0.21	0.55	
I_{SC}	Output Short Circuit Current ⁽⁶⁾	Sourcing to $V^+/2$	60 30	95		mA
		Sinking from $V^+/2$	50 15	75		
I_{OUT}	Output Current	$V_O = 0.5\text{V}$ from either Supply		± 100		mA
PSRR	Power Supply Rejection Ratio	$15\text{V} \leq V^+ \leq 17\text{V}$	72	80		dB
I_S	Supply Current	No Load		4	6.5 7.8	mA
R_{IN}	Common Mode Input Resistance	$A_V = +1$, f = 1 kHz, $R_S = 1\text{ M}\Omega$		32		$\text{M}\Omega$
C_{IN}	Common Mode Input Capacitance	$A_V = +1$, $R_S = 100\text{ k}\Omega$		1.7		pF

(1) Electrical Table values apply only for factory testing conditions at the temperature indicated. Factory testing conditions result in very limited self-heating of the device such that $T_J = T_A$. Parametric performance is indicated in the electrical tables under conditions of internal self-heating where $T_J > T_A$.

(2) All limits are specified by testing or statistical analysis.

(3) Typical Values represent the most likely parametric norm.

(4) Slew rate is the average of the rising and falling slew rates

(5) Positive current corresponds to current flowing into the device.

(6) Applies to both single-supply and split-supply operation. Continuous short circuit operation at elevated ambient temperature can result in exceeding the maximum allowed junction temperature of 150°C . Short circuit test is a momentary test. Output short circuit duration is infinite for $V_S < 6\text{V}$ at room temperature and below. For $V_S > 6\text{V}$, allowable short circuit duration is 1.5 ms.

16V Electrical Characteristics (continued)

Unless otherwise specified, All limits specified for $T_J = 25^\circ\text{C}$, $V^+ = 16\text{V}$, $V^- = 0\text{V}$, $V_O = V_{CM} = V^+/2$ and $R_L = 2\text{ k}\Omega$ to $V^+/2$.

Boldface limits apply at temperature extremes. ⁽¹⁾

Symbol	Parameter	Conditions	Min ⁽²⁾	Typ ⁽³⁾	Max ⁽²⁾	Units
R_{OUT}	Output Resistance Closed Loop	$R_F = 10\text{ k}\Omega$, $f = 1\text{ kHz}$, $A_V = -1$		0.1		Ω
		$R_F = 10\text{ k}\Omega$, $f = 1\text{ MHz}$, $A_V = -1$		0.3		
DG	Differential Gain	NTSC, $A_V = +2$ $R_L = 150\Omega$ to $V^+/2$		0.12		%
DP	Differential Phase	NTSC, $A_V = +2$ $R_L = 150\Omega$ to $V^+/2$		0.12		deg

CONNECTION DIAGRAM

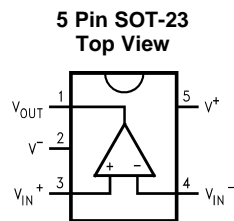

See Package Number DBV0005A

Typical Performance Characteristics

At $T_J = 25^\circ\text{C}$, $V^+ = 16\text{ V}$, $V^- = 0\text{ V}$, $R_F = 330\Omega$ for $A_V = +2$, $R_F = 1\text{ k}\Omega$ for $A_V = -1$. R_L tied to $V^+/2$. Unless otherwise specified.

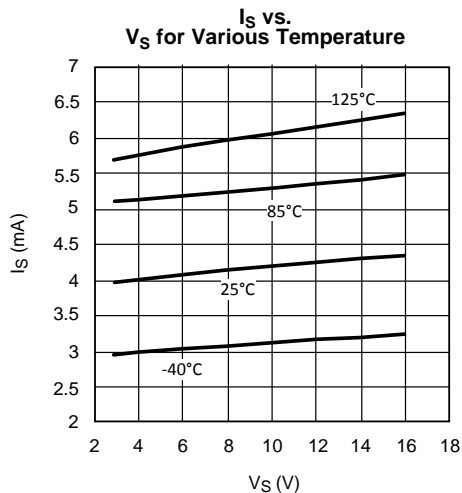

Figure 2.

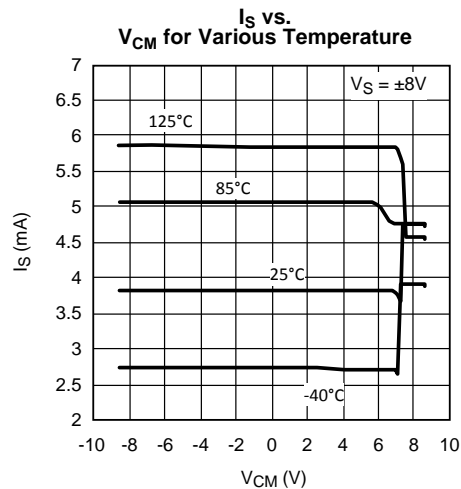

Figure 3.

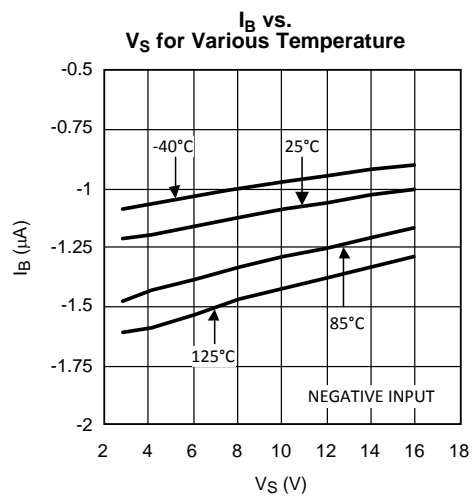

Figure 4.

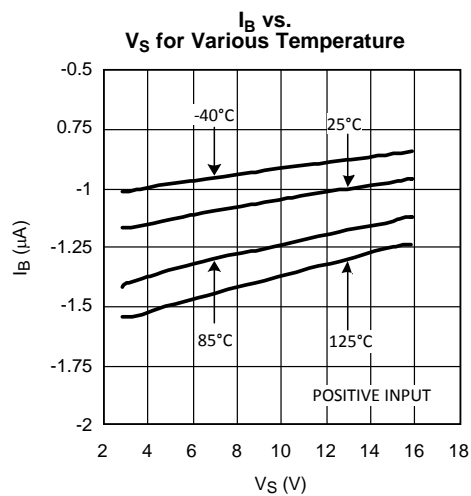

Figure 5.

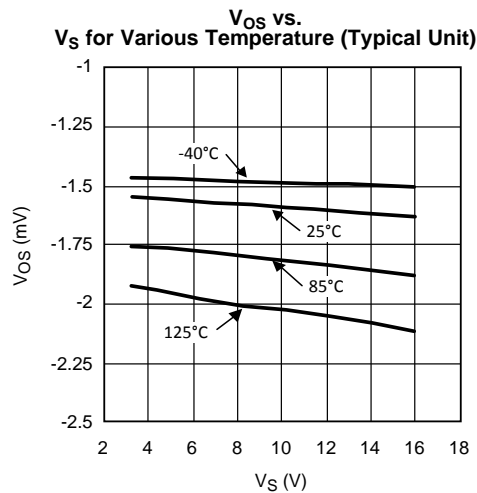

Figure 6.

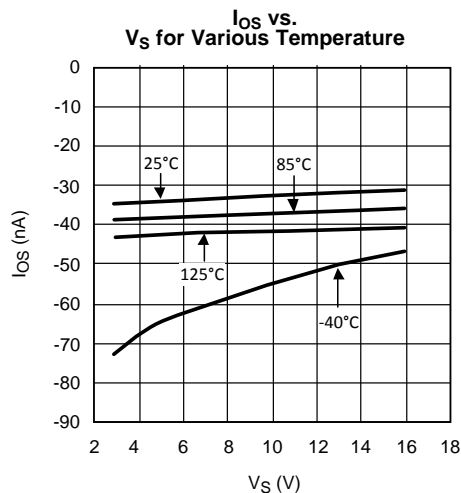

Figure 7.

Typical Performance Characteristics (continued)

At $T_J = 25^\circ\text{C}$, $V^+ = 16\text{ V}$, $V^- = 0\text{ V}$, $R_F = 330\Omega$ for $A_V = +2$, $R_F = 1\text{ k}\Omega$ for $A_V = -1$. R_L tied to $V^+/2$. Unless otherwise specified.

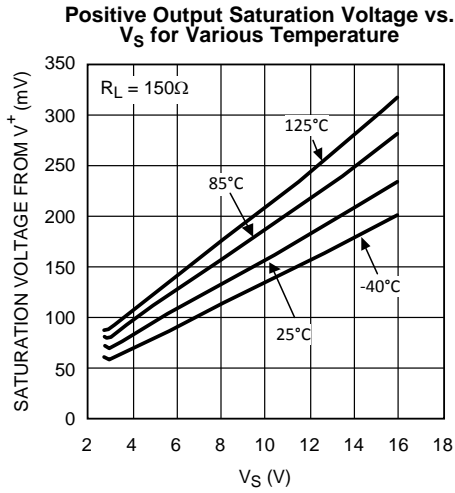

Figure 8.

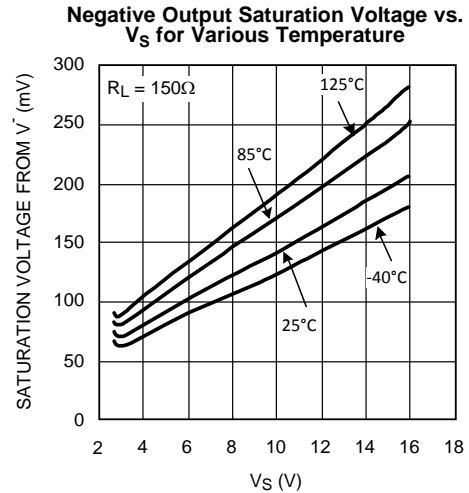

Figure 9.

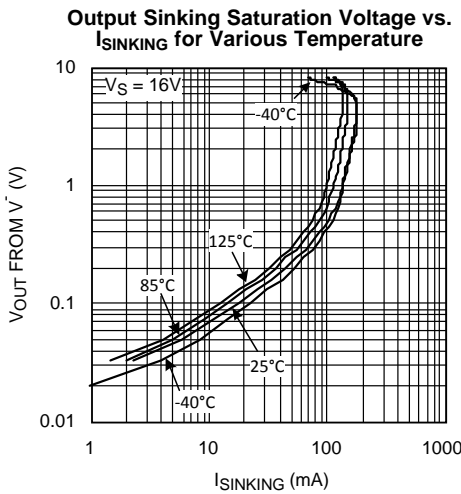

Figure 10.

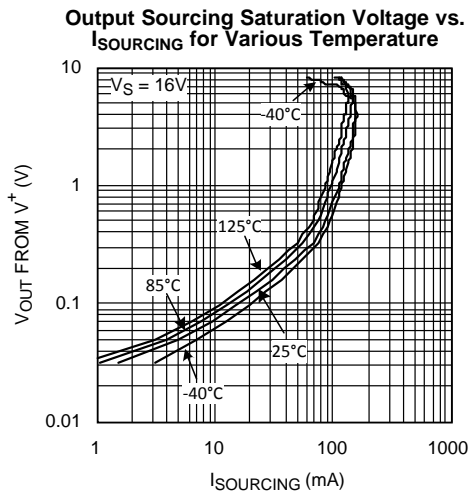

Figure 11.

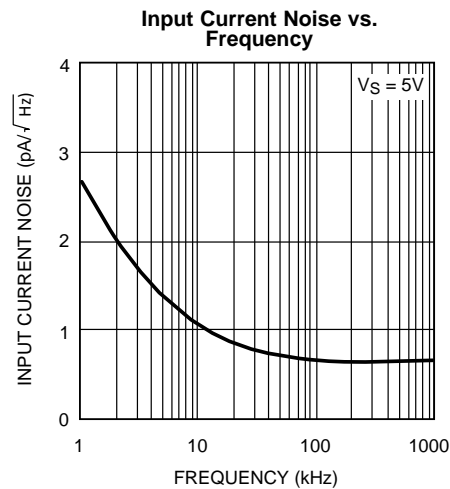

Figure 12.

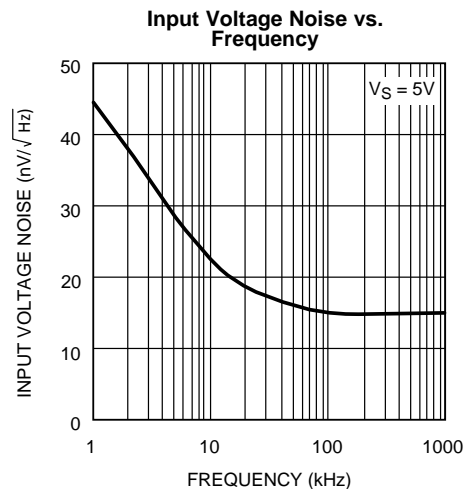

Figure 13.

Typical Performance Characteristics (continued)

At $T_J = 25^\circ\text{C}$, $V^+ = 16\text{ V}$, $V^- = 0\text{ V}$, $R_F = 330\Omega$ for $A_V = +2$, $R_F = 1\text{ k}\Omega$ for $A_V = -1$. R_L tied to $V^+/2$. Unless otherwise specified.

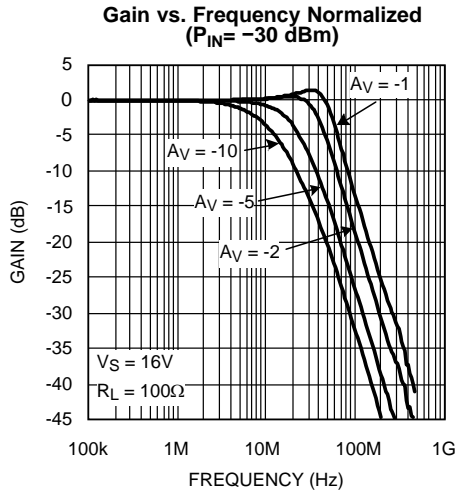

Figure 14.

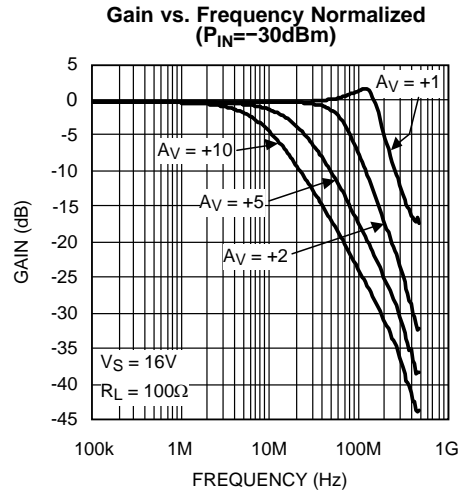

Figure 15.

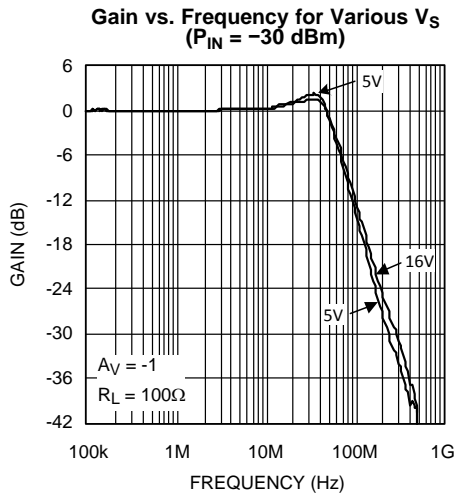

Figure 16.

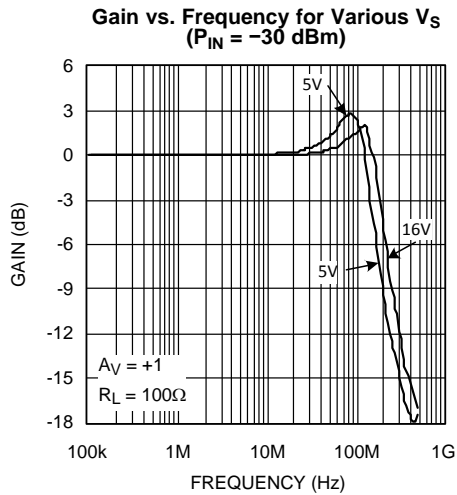

Figure 17.

Open Loop Gain & Phase vs. Frequency for Various Temperature ($P_{IN} = -30\text{ dBm}$)

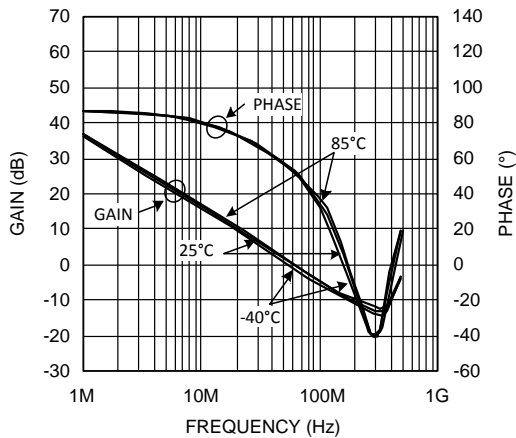

Figure 18.

Relative Gain vs. Frequency for Various Temperature ($P_{IN} = -10\text{ dBm}$)

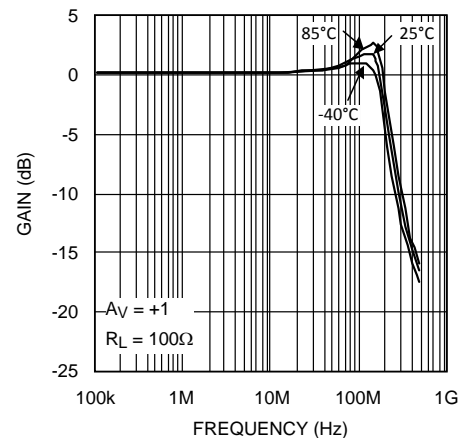

Figure 19.

Typical Performance Characteristics (continued)

At $T_J = 25^\circ\text{C}$, $V^+ = 16\text{ V}$, $V^- = 0\text{ V}$, $R_F = 330\Omega$ for $A_V = +2$, $R_F = 1\text{ k}\Omega$ for $A_V = -1$. R_L tied to $V^+/2$. Unless otherwise specified.

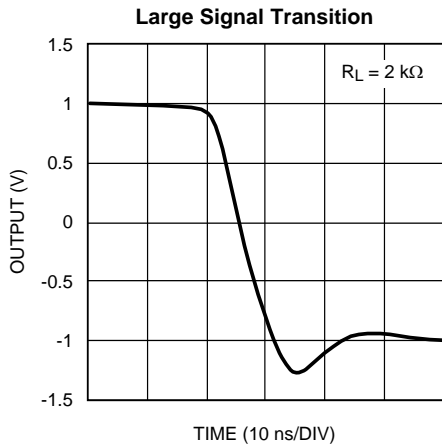

Figure 20.

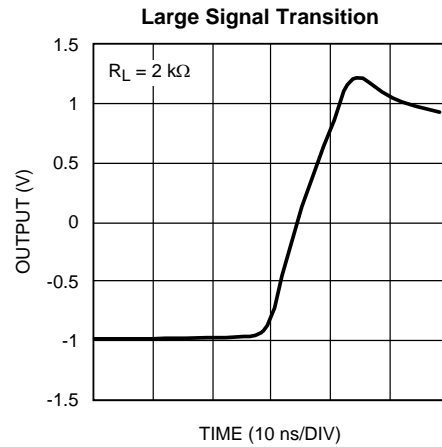

Figure 21.

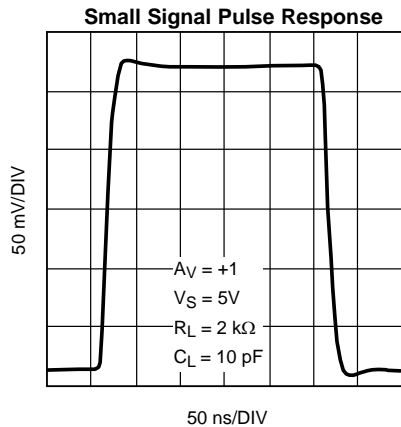

Figure 22.

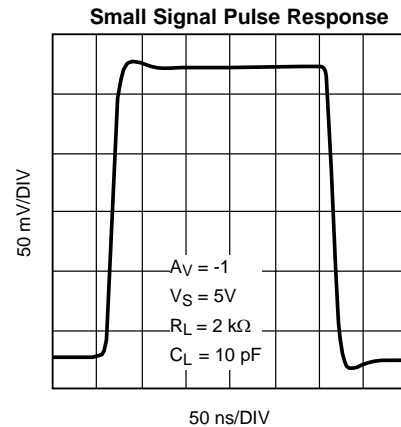

Figure 23.

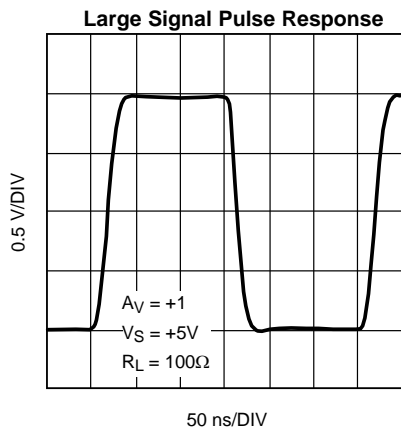

Figure 24.

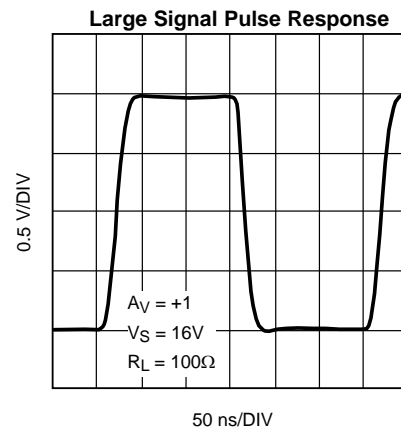

Figure 25.

Typical Performance Characteristics (continued)

At $T_J = 25^\circ\text{C}$, $V^+ = 16\text{ V}$, $V^- = 0\text{ V}$, $R_F = 330\Omega$ for $A_V = +2$, $R_F = 1\text{ k}\Omega$ for $A_V = -1$. R_L tied to $V^+/2$. Unless otherwise specified.

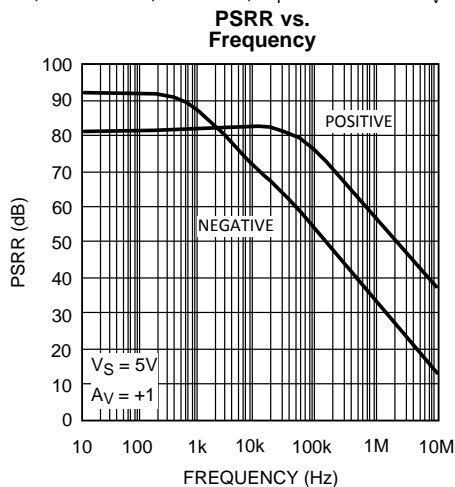

Figure 26.

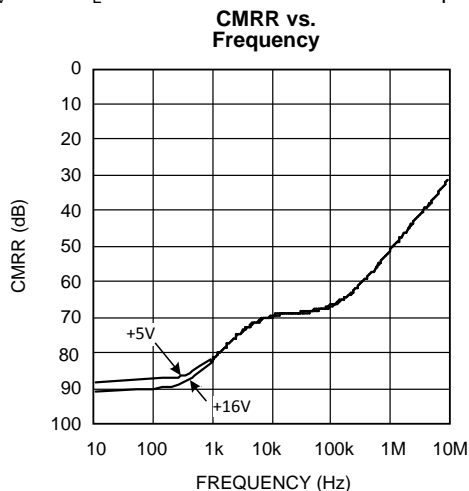

Figure 27.

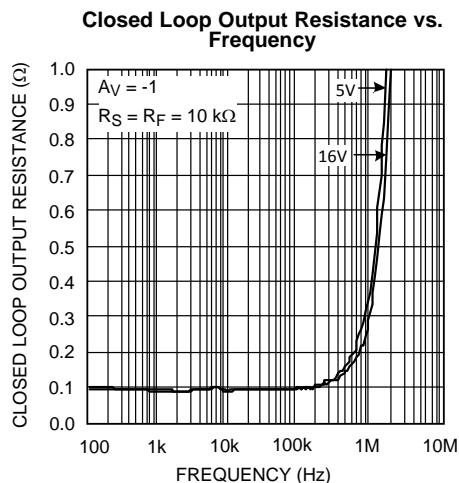

Figure 28.

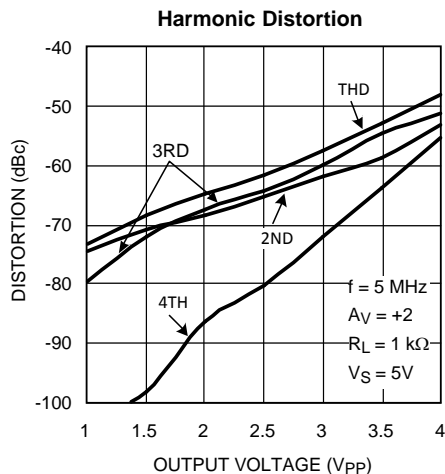

Figure 29.

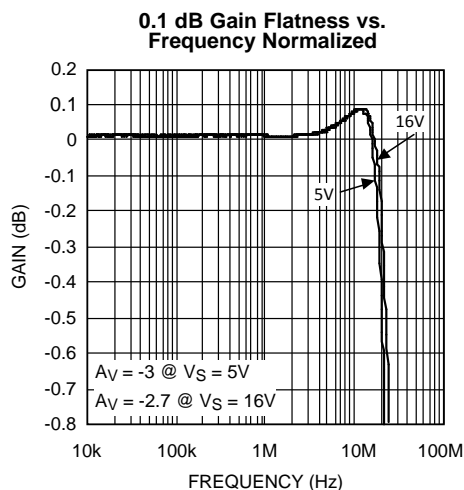

Figure 30.

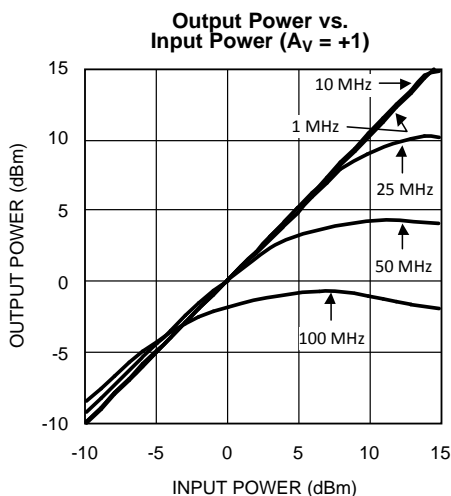
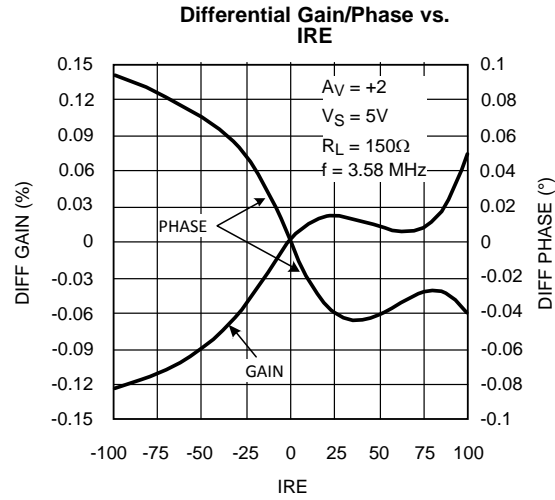

Figure 31.

Typical Performance Characteristics (continued)

At $T_J = 25^\circ\text{C}$, $V^+ = 16\text{ V}$, $V^- = 0\text{ V}$, $R_F = 330\Omega$ for $A_V = +2$, $R_F = 1\text{ k}\Omega$ for $A_V = -1$. R_L tied to $V^+/2$. Unless otherwise specified.



APPLICATION INFORMATION

Application Notes

With its high output current and speed, one of the major applications for the LMH6640 is the V_{COM} driver in a TFT panel. This application is a specially taxing one because of the demands it places on the operational amplifier's output to drive a large amount of bi-directional current into a heavy capacitive load while operating under unity gain condition, which is a difficult challenge due to loop stability reasons. For a more detailed explanation of what a TFT panel is and what its amplifier requirements are, please see the Application Notes section of the LM6584 found on the web at: <http://www.ti.com/lit/pdf/sn0sb08>

Because of the complexity of the TFT V_{COM} waveform and the wide variation in characteristics between different TFT panels, it is difficult to decipher the results of circuit testing in an actual panel. The ability to make simplifying assumptions about the load in order to test the amplifier on the bench allows testing using standard equipment and provides familiar results which could be interpreted using standard loop analysis techniques. This is what has been done in this application note with regard to the LMH6640's performance when subjected to the conditions found in a TFT V_{COM} application.

Figure 33, shows a typical simplified V_{COM} application with the LMH6640 buffering the V_{COM} potential (which is usually around $\frac{1}{2}$ of panel supply voltage) and looking into the simplified model of the load. The load represents the cumulative effect of all stray capacitances between the V_{COM} node and both row and column lines. Associated with the capacitances shown, is the distributed resistance of the lines to each individual transistor switch. The other end of this R-C ladder is driven by the column driver in an actual panel and here is driven with a low impedance MOSFET driver (labeled "High Current Driver") for the purposes of this bench test to simulate the effect that the column driver exerts on the V_{COM} load.

The modeled TFT V_{COM} load, shown in Figure 33, is based on the following simplifying assumptions in order to allow for easy bench testing and yet allow good matching results obtained in the actual application:

- The sum of all the capacitors and resistors in the R-C ladder is the total V_{COM} capacitance and resistance respectively. This total varies from panel to panel; capacitance could range from 50 nF-200 nF and the resistance could be anywhere from 20 Ω -100 Ω .
- The number of ladder sections has been reduced to a number (4 sections in this case) which can easily be put together in the lab and which behaves reasonably close to the actual load.

In this example, the LMH6640 was tested under the simulated conditions of total 209 nF capacitance and 54 Ω as shown in Figure 33.

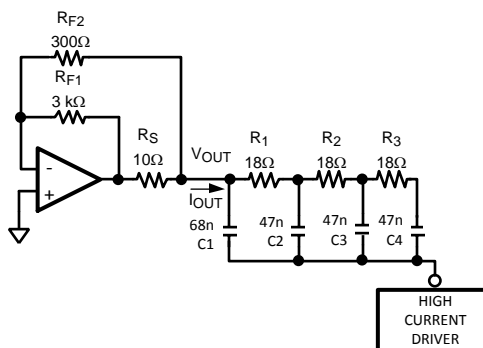

Figure 33. LMH6640 in a V_{COM} Buffer Application with Simulated TFT Load

R_S is sometimes used in the panel to provide additional isolation from the load while R_{F2} provides a more direct feedback from the V_{COM} . R_{F1} , R_{F2} , and R_S are trimmed in the actual circuit with settling time and stability trade-offs considered and evaluated. When tested under simulated load conditions of Figure 33, here are the resultant voltage and current waveforms at the LMH6640 output:

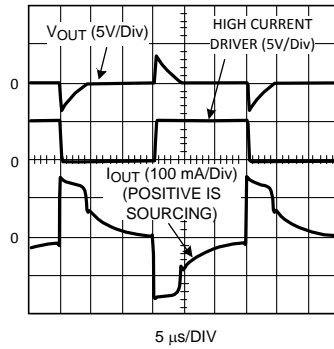

Figure 34. V_{COM} Output, High Current Drive Waveform, & LMH6640 Output Current Waveforms

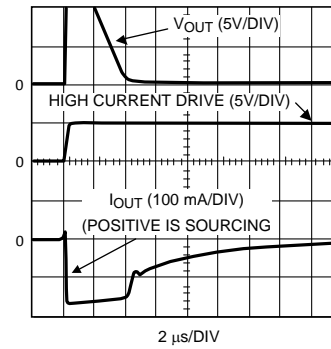

Figure 35. Expanded View of Figure 34 Waveforms showing LMH6640 Current Sinking $\frac{1}{2}$ Cycle

As can be seen, the LMH6640 is capable of supplying up to 160 mA of output current and can settle the output in 4.4 μ s.

The LMH6640 is a cost effective amplifier for use in the TFT V_{COM} application and is made even more attractive by its large supply voltage range and high output current. The combination of all these features is not readily available in the market, especially in the space saving SOT-23 5 pin package. All this performance is achieved at the low power consumption of 65 mW which is of utmost importance in today's battery driven TFT panels.

REVISION HISTORY

Changes from Revision A (March 2013) to Revision B	Page
<hr/> <ul style="list-style-type: none">• Changed layout of National Data Sheet to TI format	<hr/> 14

PACKAGING INFORMATION

Orderable Device	Status (1)	Package Type	Package Drawing	Pins	Package Qty	Eco Plan (2)	Lead/Ball Finish (6)	MSL Peak Temp (3)	Op Temp (°C)	Device Marking (4/5)	Samples
LMH6640MF	NRND	SOT-23	DBV	5		TBD	Call TI	Call TI	-40 to 85	AH1A	
LMH6640MF/NOPB	NRND	SOT-23	DBV	5	1000	Green (RoHS & no Sb/Br)	CU SN	Level-1-260C-UNLIM	-40 to 85	AH1A	
LMH6640MFX/NOPB	NRND	SOT-23	DBV	5	3000	Green (RoHS & no Sb/Br)	CU SN	Level-1-260C-UNLIM	-40 to 85	AH1A	

(1) The marketing status values are defined as follows:

ACTIVE: Product device recommended for new designs.

LIFEBUY: TI has announced that the device will be discontinued, and a lifetime-buy period is in effect.

NRND: Not recommended for new designs. Device is in production to support existing customers, but TI does not recommend using this part in a new design.

PREVIEW: Device has been announced but is not in production. Samples may or may not be available.

OBSOLETE: TI has discontinued the production of the device.

(2) Eco Plan - The planned eco-friendly classification: Pb-Free (RoHS), Pb-Free (RoHS Exempt), or Green (RoHS & no Sb/Br) - please check <http://www.ti.com/productcontent> for the latest availability information and additional product content details.

TBD: The Pb-Free/Green conversion plan has not been defined.

Pb-Free (RoHS): TI's terms "Lead-Free" or "Pb-Free" mean semiconductor products that are compatible with the current RoHS requirements for all 6 substances, including the requirement that lead not exceed 0.1% by weight in homogeneous materials. Where designed to be soldered at high temperatures, TI Pb-Free products are suitable for use in specified lead-free processes.

Pb-Free (RoHS Exempt): This component has a RoHS exemption for either 1) lead-based flip-chip solder bumps used between the die and package, or 2) lead-based die adhesive used between the die and leadframe. The component is otherwise considered Pb-Free (RoHS compatible) as defined above.

Green (RoHS & no Sb/Br): TI defines "Green" to mean Pb-Free (RoHS compatible), and free of Bromine (Br) and Antimony (Sb) based flame retardants (Br or Sb do not exceed 0.1% by weight in homogeneous material)

(3) MSL, Peak Temp. - The Moisture Sensitivity Level rating according to the JEDEC industry standard classifications, and peak solder temperature.

(4) There may be additional marking, which relates to the logo, the lot trace code information, or the environmental category on the device.

(5) Multiple Device Markings will be inside parentheses. Only one Device Marking contained in parentheses and separated by a "~" will appear on a device. If a line is indented then it is a continuation of the previous line and the two combined represent the entire Device Marking for that device.

(6) Lead/Ball Finish - Orderable Devices may have multiple material finish options. Finish options are separated by a vertical ruled line. Lead/Ball Finish values may wrap to two lines if the finish value exceeds the maximum column width.

Important Information and Disclaimer: The information provided on this page represents TI's knowledge and belief as of the date that it is provided. TI bases its knowledge and belief on information provided by third parties, and makes no representation or warranty as to the accuracy of such information. Efforts are underway to better integrate information from third parties. TI has taken and

continues to take reasonable steps to provide representative and accurate information but may not have conducted destructive testing or chemical analysis on incoming materials and chemicals. TI and TI suppliers consider certain information to be proprietary, and thus CAS numbers and other limited information may not be available for release.

In no event shall TI's liability arising out of such information exceed the total purchase price of the TI part(s) at issue in this document sold by TI to Customer on an annual basis.

TAPE AND REEL INFORMATION



QUADRANT ASSIGNMENTS FOR PIN 1 ORIENTATION IN TAPE



*All dimensions are nominal

Device	Package Type	Package Drawing	Pins	SPQ	Reel Diameter (mm)	Reel Width W1 (mm)	A0 (mm)	B0 (mm)	K0 (mm)	P1 (mm)	W (mm)	Pin1 Quadrant
LMH6640MF/NOPB	SOT-23	DBV	5	1000	178.0	8.4	3.2	3.2	1.4	4.0	8.0	Q3
LMH6640MFX/NOPB	SOT-23	DBV	5	3000	178.0	8.4	3.2	3.2	1.4	4.0	8.0	Q3

TAPE AND REEL BOX DIMENSIONS

*All dimensions are nominal

Device	Package Type	Package Drawing	Pins	SPQ	Length (mm)	Width (mm)	Height (mm)
LMH6640MF/NOPB	SOT-23	DBV	5	1000	210.0	185.0	35.0
LMH6640MFX/NOPB	SOT-23	DBV	5	3000	210.0	185.0	35.0

DBV (R-PDSO-G5)

PLASTIC SMALL-OUTLINE PACKAGE

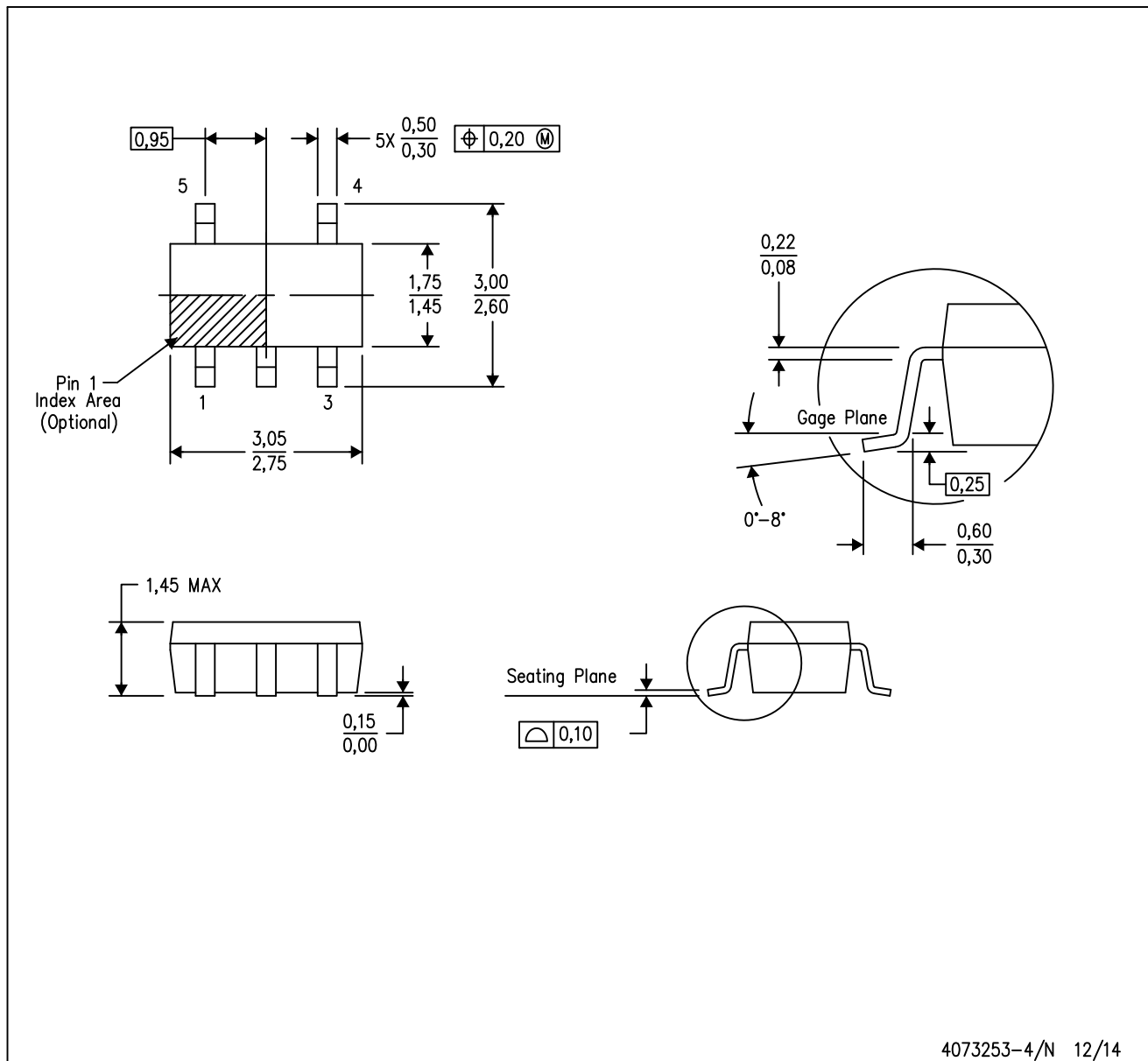

- NOTES:
- A. All linear dimensions are in millimeters.
 - B. This drawing is subject to change without notice.
 - C. Body dimensions do not include mold flash or protrusion. Mold flash and protrusion shall not exceed 0.15 per side.
 - D. Falls within JEDEC MO-178 Variation AA.

DBV (R-PDSO-G5)

PLASTIC SMALL OUTLINE



- NOTES:
- A. All linear dimensions are in millimeters.
 - B. This drawing is subject to change without notice.
 - C. Customers should place a note on the circuit board fabrication drawing not to alter the center solder mask defined pad.
 - D. Publication IPC-7351 is recommended for alternate designs.
 - E. Laser cutting apertures with trapezoidal walls and also rounding corners will offer better paste release. Customers should contact their board assembly site for stencil design recommendations. Example stencil design based on a 50% volumetric metal load solder paste. Refer to IPC-7525 for other stencil recommendations.

IMPORTANT NOTICE

Texas Instruments Incorporated and its subsidiaries (TI) reserve the right to make corrections, enhancements, improvements and other changes to its semiconductor products and services per JESD46, latest issue, and to discontinue any product or service per JESD48, latest issue. Buyers should obtain the latest relevant information before placing orders and should verify that such information is current and complete. All semiconductor products (also referred to herein as "components") are sold subject to TI's terms and conditions of sale supplied at the time of order acknowledgment.

TI warrants performance of its components to the specifications applicable at the time of sale, in accordance with the warranty in TI's terms and conditions of sale of semiconductor products. Testing and other quality control techniques are used to the extent TI deems necessary to support this warranty. Except where mandated by applicable law, testing of all parameters of each component is not necessarily performed.

TI assumes no liability for applications assistance or the design of Buyers' products. Buyers are responsible for their products and applications using TI components. To minimize the risks associated with Buyers' products and applications, Buyers should provide adequate design and operating safeguards.

TI does not warrant or represent that any license, either express or implied, is granted under any patent right, copyright, mask work right, or other intellectual property right relating to any combination, machine, or process in which TI components or services are used. Information published by TI regarding third-party products or services does not constitute a license to use such products or services or a warranty or endorsement thereof. Use of such information may require a license from a third party under the patents or other intellectual property of the third party, or a license from TI under the patents or other intellectual property of TI.

Reproduction of significant portions of TI information in TI data books or data sheets is permissible only if reproduction is without alteration and is accompanied by all associated warranties, conditions, limitations, and notices. TI is not responsible or liable for such altered documentation. Information of third parties may be subject to additional restrictions.

Resale of TI components or services with statements different from or beyond the parameters stated by TI for that component or service voids all express and any implied warranties for the associated TI component or service and is an unfair and deceptive business practice. TI is not responsible or liable for any such statements.

Buyer acknowledges and agrees that it is solely responsible for compliance with all legal, regulatory and safety-related requirements concerning its products, and any use of TI components in its applications, notwithstanding any applications-related information or support that may be provided by TI. Buyer represents and agrees that it has all the necessary expertise to create and implement safeguards which anticipate dangerous consequences of failures, monitor failures and their consequences, lessen the likelihood of failures that might cause harm and take appropriate remedial actions. Buyer will fully indemnify TI and its representatives against any damages arising out of the use of any TI components in safety-critical applications.

In some cases, TI components may be promoted specifically to facilitate safety-related applications. With such components, TI's goal is to help enable customers to design and create their own end-product solutions that meet applicable functional safety standards and requirements. Nonetheless, such components are subject to these terms.

No TI components are authorized for use in FDA Class III (or similar life-critical medical equipment) unless authorized officers of the parties have executed a special agreement specifically governing such use.

Only those TI components which TI has specifically designated as military grade or "enhanced plastic" are designed and intended for use in military/aerospace applications or environments. Buyer acknowledges and agrees that any military or aerospace use of TI components which have **not** been so designated is solely at the Buyer's risk, and that Buyer is solely responsible for compliance with all legal and regulatory requirements in connection with such use.

TI has specifically designated certain components as meeting ISO/TS16949 requirements, mainly for automotive use. In any case of use of non-designated products, TI will not be responsible for any failure to meet ISO/TS16949.

Products

Audio	www.ti.com/audio
Amplifiers	amplifier.ti.com
Data Converters	dataconverter.ti.com
DLP® Products	www.dlp.com
DSP	dsp.ti.com
Clocks and Timers	www.ti.com/clocks
Interface	interface.ti.com
Logic	logic.ti.com
Power Mgmt	power.ti.com
Microcontrollers	microcontroller.ti.com
RFID	www.ti-rfid.com
OMAP Applications Processors	www.ti.com/omap
Wireless Connectivity	www.ti.com/wirelessconnectivity

Applications

Automotive and Transportation	www.ti.com/automotive
Communications and Telecom	www.ti.com/communications
Computers and Peripherals	www.ti.com/computers
Consumer Electronics	www.ti.com/consumer-apps
Energy and Lighting	www.ti.com/energy
Industrial	www.ti.com/industrial
Medical	www.ti.com/medical
Security	www.ti.com/security
Space, Avionics and Defense	www.ti.com/space-avionics-defense
Video and Imaging	www.ti.com/video

TI E2E Community

e2e.ti.com