

LM340-N/LM78XX Series 3-Terminal Positive Regulators

 Check for Samples: [LM340-N](#), [LM78xx](#)

FEATURES

- Complete Specifications at 1A Load
- Output Voltage Tolerances of $\pm 2\%$ at $T_j = 25^\circ\text{C}$ and $\pm 4\%$ Over the Temperature Range (LM340A)
- Line Regulation of 0.01% of V_{OUT}/V of ΔV_{IN} at 1A Load (LM340A)
- Load Regulation of 0.3% of V_{OUT}/A (LM340A)
- Internal Thermal Overload Protection
- Internal Short-circuit Current Limit
- Output Transistor Safe Area Protection
- P* Product Enhancement Tested

DESCRIPTION

The LM140/LM340A/LM340-N/LM78XXC monolithic 3-terminal positive voltage regulators employ internal current-limiting, thermal shutdown and safe-area compensation, making them essentially indestructible. If adequate heat sinking is provided, they can deliver over 1.0A output current. They are intended as fixed voltage regulators in a wide range of applications including local (on-card) regulation for elimination of noise and distribution problems associated with single-point regulation. In addition to use as fixed voltage regulators, these devices can be used with external components to obtain adjustable output voltages and currents.

Considerable effort was expended to make the entire series of regulators easy to use and minimize the number of external components. It is not necessary to bypass the output, although this does improve transient response. Input bypassing is needed only if the regulator is located far from the filter capacitor of the power supply.

The 5V, 12V, and 15V regulator options are available in the steel TO-3 power package. The LM340A/LM340-N/LM78XXC series is available in the TO-220 plastic power package, and the LM340-N-5.0 is available in the SOT-223 package, as well as the LM340-5.0 and LM340-12 in the surface-mount DPAK/TO-263 package.

Typical Applications

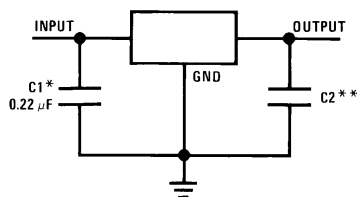

*Required if the regulator is located far from the power supply filter.

**Although no output capacitor is needed for stability, it does help transient response. (If needed, use 0.1 μF , ceramic disc).

Figure 1. Fixed Output Regulator

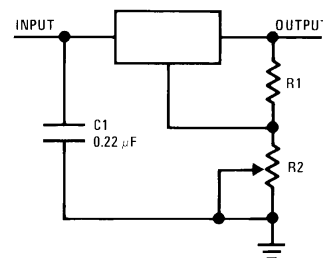

$$V_{\text{OUT}} = 5V + (5V/R1 + I_Q) R2 \quad 5V/R1 > 3 I_Q,$$

$$\text{load regulation } (L_r) \approx [(R1 + R2)/R1] \quad (L_r \text{ of LM340-5}).$$

Figure 2. Adjustable Output Regulator



Please be aware that an important notice concerning availability, standard warranty, and use in critical applications of Texas Instruments semiconductor products and disclaimers thereto appears at the end of this data sheet.

All trademarks are the property of their respective owners.

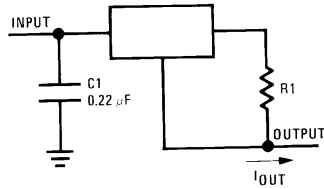

$$I_{OUT} = \frac{V_{2-3}}{R_1} + I_Q$$

$\Delta I_Q = 1.3 \text{ mA}$ over line and load changes.

Figure 3. Current Regulator

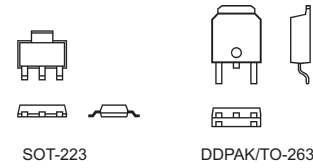

Figure 4. Comparison between SOT-223 and DDPAK/TO-263 Packages Scale 1:1

Connection Diagrams

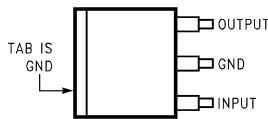

Figure 5. DDPAK/TO-263 Surface-Mount Package Top View See Package Number KTT0003B

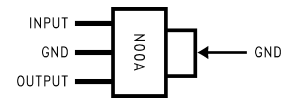

Figure 6. 3-Lead SOT-223 Top View See Package Number DCY



These devices have limited built-in ESD protection. The leads should be shorted together or the device placed in conductive foam during storage or handling to prevent electrostatic damage to the MOS gates.

Absolute Maximum Ratings⁽¹⁾⁽²⁾⁽³⁾

DC Input Voltage		35V
Internal Power Dissipation ⁽⁴⁾		Internally Limited
Maximum Junction Temperature		150°C
Storage Temperature Range		-65°C to +150°C
Lead Temperature (Soldering, 10 sec.)	TO-3 Package (NDS)	300°C
	TO-220 Package (NDE), DDPAK/TO-263 Package (KTT)	230°C
ESD Susceptibility ⁽⁵⁾		2 kV

- (1) Absolute Maximum Ratings are limits beyond which damage to the device may occur. Operating Conditions are conditions under which the device functions but the specifications might not be ensured. For ensured specifications and test conditions see the Electrical Characteristics.
- (2) Military datasheets are available upon request. At the time of printing, the military datasheet specifications for the LM140K-5.0/883, LM140K-12/883, and LM140K-15/883 complied with the min and max limits for the respective versions of the LM140. The LM140H and LM140K may also be procured as JAN devices on slash sheet JM38510/107.
- (3) If Military/Aerospace specified devices are required, please contact the Texas Instruments Sales Office/Distributors for availability and specifications.
- (4) The maximum allowable power dissipation at any ambient temperature is a function of the maximum junction temperature for operation ($T_{JMAX} = 125^\circ\text{C}$ or 150°C), the junction-to-ambient thermal resistance (θ_{JA}), and the ambient temperature (T_A). $P_{DMAX} = (T_{JMAX} - T_A)/\theta_{JA}$. If this dissipation is exceeded, the die temperature will rise above T_{JMAX} and the electrical specifications do not apply. If the die temperature rises above 150°C , the device will go into thermal shutdown. For the TO-3 package (NDS), the junction-to-ambient thermal resistance (θ_{JA}) is 39°C/W . When using a heatsink, θ_{JA} is the sum of the 4°C/W junction-to-case thermal resistance (θ_{JC}) of the TO-3 package and the case-to-ambient thermal resistance of the heatsink. For the TO-220 package (NDE), θ_{JA} is 54°C/W and θ_{JC} is 4°C/W . If SOT-223 is used, the junction-to-ambient thermal resistance is 174°C/W and can be reduced by a heatsink (see Applications Hints on heatsinking). If the DDPAK/TO-263 package is used, the thermal resistance can be reduced by increasing the PC board copper area thermally connected to the package: Using 0.5 square inches of copper area, θ_{JA} is 50°C/W ; with 1 square inch of copper area, θ_{JA} is 37°C/W ; and with 1.6 or more inches of copper area, θ_{JA} is 32°C/W .
- (5) ESD rating is based on the human body model, 100 pF discharged through 1.5 kΩ.

Operating Conditions⁽¹⁾

- (1) Absolute Maximum Ratings are limits beyond which damage to the device may occur. Operating Conditions are conditions under which the device functions but the specifications might not be ensured. For ensured specifications and test conditions see the Electrical Characteristics.

Operating Conditions⁽¹⁾ (continued)

Temperature Range (T _A) ⁽²⁾	LM140	-55°C to +125°C
	LM340A, LM340-N	0°C to +125°C
	LM7808C	0°C to +125°C

- (2) The maximum allowable power dissipation at any ambient temperature is a function of the maximum junction temperature for operation (T_{JMAX} = 125°C or 150°C), the junction-to-ambient thermal resistance (θ_{JA}), and the ambient temperature (T_A). $P_{DMAX} = (T_{JMAX} - T_A) / \theta_{JA}$. If this dissipation is exceeded, the die temperature will rise above T_{JMAX} and the electrical specifications do not apply. If the die temperature rises above 150°C, the device will go into thermal shutdown. For the TO-3 package (NDS), the junction-to-ambient thermal resistance (θ_{JA}) is 39°C/W. When using a heatsink, θ_{JA} is the sum of the 4°C/W junction-to-case thermal resistance (θ_{JC}) of the TO-3 package and the case-to-ambient thermal resistance of the heatsink. For the TO-220 package (NDE), θ_{JA} is 54°C/W and θ_{JC} is 4°C/W. If SOT-223 is used, the junction-to-ambient thermal resistance is 174°C/W and can be reduced by a heatsink (see Applications Hints on heatsinking). If the DDPAK\TO-263 package is used, the thermal resistance can be reduced by increasing the PC board copper area thermally connected to the package: Using 0.5 square inches of copper area, θ_{JA} is 50°C/W; with 1 square inch of copper area, θ_{JA} is 37°C/W; and with 1.6 or more inches of copper area, θ_{JA} is 32°C/W.

LM340A Electrical Characteristics

 $I_{OUT} = 1A, 0^{\circ}C \leq T_J \leq +125^{\circ}C$ (LM340A) unless otherwise specified⁽¹⁾

Symbol	Output Voltage		5V			12V			15V			Units	
	Input Voltage (unless otherwise noted)		10V			19V			23V				
	Parameter	Conditions	Min	Typ	Max	Min	Typ	Max	Min	Typ	Max		
V_O	Output Voltage	$T_J = 25^{\circ}C$	4.9	5	5.1	11.75	12	12.25	14.7	15	15.3	V	
		$P_D \leq 15W, 5 mA \leq I_O \leq 1A$	4.8		5.2	11.5		12.5	14.4		15.6	V	
		$V_{MIN} \leq V_{IN} \leq V_{MAX}$	(7.5 $\leq V_{IN} \leq 20$)			(14.8 $\leq V_{IN} \leq 27$)			(17.9 $\leq V_{IN} \leq 30$)			V	
ΔV_O	Line Regulation	$I_O = 500 mA$	10			18			22			mV	
		ΔV_{IN}	(7.5 $\leq V_{IN} \leq 20$)			(14.8 $\leq V_{IN} \leq 27$)			(17.9 $\leq V_{IN} \leq 30$)			V	
		$T_J = 25^{\circ}C$	3 10			4 18			4 22			mV	
		ΔV_{IN}	(7.5 $\leq V_{IN} \leq 20$)			(14.5 $\leq V_{IN} \leq 27$)			(17.5 $\leq V_{IN} \leq 30$)			V	
ΔV_O	Load Regulation	$T_J = 25^{\circ}C$	10 25			12 32			12 35			mV	
		$5 mA \leq I_O \leq 1.5A$							21			mV	
		$250 mA \leq I_O \leq 750 mA$	15			19			21			mV	
ΔV_O	Over Temperature, $5 mA \leq I_O \leq 1A$	ΔV_{IN}	25			60			75			mV	
		ΔV_{IN}	(8 $\leq V_{IN} \leq 12$)			(16 $\leq V_{IN} \leq 22$)			(20 $\leq V_{IN} \leq 26$)			V	
I_Q	Quiescent Current	$T_J = 25^{\circ}C$	6			6			6			mA	
		Over Temperature	6.5			6.5			6.5			mA	
ΔI_Q	Quiescent Current Change	$5 mA \leq I_O \leq 1A$	0.5			0.5			0.5			mA	
		$T_J = 25^{\circ}C, I_O = 1A$	0.8			0.8			0.8			mA	
		$V_{MIN} \leq V_{IN} \leq V_{MAX}$	(7.5 $\leq V_{IN} \leq 20$)			(14.8 $\leq V_{IN} \leq 27$)			(17.9 $\leq V_{IN} \leq 30$)			V	
		$I_O = 500 mA$	0.8			0.8			0.8			mA	
V_N	Output Noise Voltage	$T_A = 25^{\circ}C, 10 Hz \leq f \leq 100 kHz$	40			75			90			μV	
		ΔV_{IN} ΔV_{OUT}	68 80			61 72			60 70			dB	
R_O	Dropout Voltage	$T_J = 25^{\circ}C, I_O = 1A$	2.0			2.0			2.0			V	
		$f = 1 kHz$	8			18			19			m Ω	
		Short-Circuit Current	2.1			1.5			1.2			A	
		Peak Output Current	2.4			2.4			2.4			A	
		Average TC of V_O	Min, $T_J = 0^{\circ}C, I_O = 5 mA$			-0.6			-1.5			-1.8	
V_{IN}	Input Voltage Required to Maintain Line Regulation	$T_J = 25^{\circ}C$	7.5			14.5			17.5			V	

(1) All characteristics are measured with a 0.22 μF capacitor from input to ground and a 0.1 μF capacitor from output to ground. All characteristics except noise voltage and ripple rejection ratio are measured using pulse techniques ($t_w \leq 10 ms$, duty cycle $\leq 5\%$). Output voltage changes due to changes in internal temperature must be taken into account separately.

LM140 Electrical Characteristics⁽¹⁾

 –55°C ≤ T_J ≤ +150°C unless otherwise specified

Symbol	Output Voltage		5V			12V			15V			Units
	Input Voltage (unless otherwise noted)		10V			19V			23V			
	Parameter	Conditions	Min	Typ	Max	Min	Typ	Max	Min	Typ	Max	
V _O	Output Voltage	T _J = 25°C, 5 mA ≤ I _O ≤ 1 A	4.8	5	5.2	11.5	12	12.5	14.4	15	15.6	V
		P _D ≤ 15W, 5 mA ≤ I _O ≤ 1 A	4.75		5.25	11.4		12.6	14.25		15.75	V
		V _{MIN} ≤ V _{IN} ≤ V _{MAX}	(8 ≤ V _{IN} ≤ 20)			(15.5 ≤ V _{IN} ≤ 27)			(18.5 ≤ V _{IN} ≤ 30)			V
ΔV _O	Line Regulation	I _O = 500 mA	T _J = 25°C	3 50		4 120		4 150		mV		
			ΔV _{IN}	(7 ≤ V _{IN} ≤ 25)		(14.5 ≤ V _{IN} ≤ 30)		(17.5 ≤ V _{IN} ≤ 30)		V		
			–55°C ≤ T _J ≤ +150°C	50		120		150		mV		
			ΔV _{IN}	(8 ≤ V _{IN} ≤ 20)		(15 ≤ V _{IN} ≤ 27)		(18.5 ≤ V _{IN} ≤ 30)		V		
		I _O ≤ 1 A	T _J = 25°C	50		120		150		mV		
			ΔV _{IN}	(7.5 ≤ V _{IN} ≤ 20)		(14.6 ≤ V _{IN} ≤ 27)		(17.7 ≤ V _{IN} ≤ 30)		V		
			–55°C ≤ T _J ≤ +150°C	25		60		75		mV		
			ΔV _{IN}	(8 ≤ V _{IN} ≤ 12)		(16 ≤ V _{IN} ≤ 22)		(20 ≤ V _{IN} ≤ 26)		V		
ΔV _O	Load Regulation	T _J = 25°C	5 mA ≤ I _O ≤ 1.5 A	10 50		12 120		12 150		mV		
			250 mA ≤ I _P ≤ 750 mA	25		60		75		mV		
		–55°C ≤ T _J ≤ +150°C, 5 mA ≤ I _O ≤ 1 A	50		120		150		mV			
I _Q	Quiescent Current	I _O ≤ 1 A	T _J = 25°C	6		6		6		mA		
			–55°C ≤ T _J ≤ +150°C	7		7		7		mA		
ΔI _Q	Quiescent Current Change	5 mA ≤ I _O ≤ 1 A		0.5		0.5		0.5		mA		
		T _J = 25°C, I _O ≤ 1 A		0.8		0.8		0.8		mA		
		V _{MIN} ≤ V _{IN} ≤ V _{MAX}		(8 ≤ V _{IN} ≤ 20)		(15 ≤ V _{IN} ≤ 27)		(18.5 ≤ V _{IN} ≤ 30)		V		
		I _O = 500 mA, –55°C ≤ T _J ≤ +150°C		0.8		0.8		0.8		mA		
V _N	Output Noise Voltage	T _A = 25°C, 10 Hz ≤ f ≤ 100 kHz		40		75		90		μV		
		V _{MIN} ≤ V _{IN} ≤ V _{MAX}		(8 ≤ V _{IN} ≤ 25)		(15 ≤ V _{IN} ≤ 30)		(18.5 ≤ V _{IN} ≤ 30)		V		
ΔV _{IN} / ΔV _{OUT}	Ripple Rejection	f = 120 Hz	I _O ≤ 1 A, T _J = 25°C or	68	80	61	72	60	70	dB		
			I _O ≤ 500 mA, –55°C ≤ T _J ≤ +150°C	68		61		60		dB		
		V _{MIN} ≤ V _{IN} ≤ V _{MAX}		(8 ≤ V _{IN} ≤ 18)		(15 ≤ V _{IN} ≤ 25)		(18.5 ≤ V _{IN} ≤ 28.5)		V		
R _O	Dropout Voltage	T _J = 25°C, I _O = 1 A		2.0		2.0		2.0		V		
	Output Resistance	f = 1 kHz		8		18		19		mΩ		
	Short-Circuit Current	T _J = 25°C		2.1		1.5		1.2		A		
	Peak Output Current	T _J = 25°C		2.4		2.4		2.4		A		
	Average TC of V _{OUT}	0°C ≤ T _J ≤ +150°C, I _O = 5 mA		–0.6		–1.5		–1.8		mV/°C		

(1) All characteristics are measured with a 0.22 μF capacitor from input to ground and a 0.1 μF capacitor from output to ground. All characteristics except noise voltage and ripple rejection ratio are measured using pulse techniques (t_w ≤ 10 ms, duty cycle ≤ 5%). Output voltage changes due to changes in internal temperature must be taken into account separately.

LM140 Electrical Characteristics⁽¹⁾ (continued)

–55°C ≤ T_J ≤ +150°C unless otherwise specified

Symbol	Output Voltage		5V			12V			15V			Units
	Input Voltage (unless otherwise noted)		10V			19V			23V			
	Parameter	Conditions	Min	Typ	Max	Min	Typ	Max	Min	Typ	Max	
V _{IN}	Input Voltage Required to Maintain Line Regulation	T _J = 25°C, I _O ≤ 1A	7.5			14.6			17.7			V

LM340-N Electrical Characteristics⁽¹⁾

0°C ≤ T_J ≤ +125°C unless otherwise specified

Symbol	Output Voltage		5V			12V			15V			Units
	Input Voltage (unless otherwise noted)		10V			19V			23V			
	Parameter	Conditions	Min	Typ	Max	Min	Typ	Max	Min	Typ	Max	
V _O	Output Voltage	T _J = 25°C, 5 mA ≤ I _O ≤ 1A	4.8	5	5.2	11.5	12	12.5	14.4	15	15.6	V
		P _D ≤ 15W, 5 mA ≤ I _O ≤ 1A	4.75		5.25	11.4		12.6	14.25		15.75	V
		V _{MIN} ≤ V _{IN} ≤ V _{MAX}	(7.5 ≤ V _{IN} ≤ 20)			(14.5 ≤ V _{IN} ≤ 27)			(17.5 ≤ V _{IN} ≤ 30)			V
ΔV _O	Line Regulation	I _O = 500 mA	T _J = 25°C	3 50		4 120		4 150		mV		
			ΔV _{IN}	(7 ≤ V _{IN} ≤ 25)		(14.5 ≤ V _{IN} ≤ 30)		(17.5 ≤ V _{IN} ≤ 30)		V		
			0°C ≤ T _J ≤ +125°C	50		120		150		mV		
		I _O ≤ 1A	T _J = 25°C	50		120		150		mV		
			ΔV _{IN}	(7.5 ≤ V _{IN} ≤ 20)		(14.6 ≤ V _{IN} ≤ 27)		(17.7 ≤ V _{IN} ≤ 30)		V		
			0°C ≤ T _J ≤ +125°C	25		60		75		mV		
ΔV _{IN}	(8 ≤ V _{IN} ≤ 12)		(16 ≤ V _{IN} ≤ 22)		(20 ≤ V _{IN} ≤ 26)		V					
ΔV _O	Load Regulation	T _J = 25°C	5 mA ≤ I _O ≤ 1.5A	10 50		12 120		12 150		mV		
			250 mA ≤ I _O ≤ 750 mA	25		60		75		mV		
		5 mA ≤ I _O ≤ 1A, 0°C ≤ T _J ≤ +125°C	50		120		150		mV			
I _Q	Quiescent Current	I _O ≤ 1A	T _J = 25°C	8		8		8		mA		
			0°C ≤ T _J ≤ +125°C	8.5		8.5		8.5		mA		
ΔI _Q	Quiescent Current Change	5 mA ≤ I _O ≤ 1A		0.5		0.5		0.5		mA		
		T _J = 25°C, I _O ≤ 1A		1.0		1.0		1.0		mA		
		V _{MIN} ≤ V _{IN} ≤ V _{MAX}		(7.5 ≤ V _{IN} ≤ 20)		(14.8 ≤ V _{IN} ≤ 27)		(17.9 ≤ V _{IN} ≤ 30)		V		
		I _O ≤ 500 mA, 0°C ≤ T _J ≤ +125°C		1.0		1.0		1.0		mA		
V _N	Output Noise Voltage	T _A = 25°C, 10 Hz ≤ f ≤ 100 kHz		40		75		90		μV		
		V _{MIN} ≤ V _{IN} ≤ V _{MAX}		(8 ≤ V _{IN} ≤ 18)		(15 ≤ V _{IN} ≤ 25)		(18.5 ≤ V _{IN} ≤ 28.5)		V		
$\frac{\Delta V_{IN}}{\Delta V_{OUT}}$	Ripple Rejection	f = 120 Hz	I _O ≤ 1A, T _J = 25°C	62	80	55	72	54	70	dB		
			or I _O ≤ 500 mA, 0°C ≤ T _J ≤ +125°C	62		55		54		dB		
		V _{MIN} ≤ V _{IN} ≤ V _{MAX}		(8 ≤ V _{IN} ≤ 18)		(15 ≤ V _{IN} ≤ 25)		(18.5 ≤ V _{IN} ≤ 28.5)		V		

(1) All characteristics are measured with a 0.22 μF capacitor from input to ground and a 0.1 μF capacitor from output to ground. All characteristics except noise voltage and ripple rejection ratio are measured using pulse techniques (t_w ≤ 10 ms, duty cycle ≤ 5%). Output voltage changes due to changes in internal temperature must be taken into account separately.

LM340-N Electrical Characteristics⁽¹⁾ (continued)
 $0^{\circ}\text{C} \leq T_J \leq +125^{\circ}\text{C}$ unless otherwise specified

Symbol	Output Voltage		5V			12V			15V			Units
	Input Voltage (unless otherwise noted)		10V			19V			23V			
	Parameter	Conditions	Min	Typ	Max	Min	Typ	Max	Min	Typ	Max	
R _O	Dropout Voltage	T _J = 25°C, I _O = 1A	2.0			2.0			2.0			V
	Output Resistance	f = 1 kHz	8			18			19			mΩ
	Short-Circuit Current	T _J = 25°C	2.1			1.5			1.2			A
	Peak Output Current	T _J = 25°C	2.4			2.4			2.4			A
	Average TC of V _{OUT}	0°C ≤ T _J ≤ +125°C, I _O = 5 mA	-0.6			-1.5			-1.8			mV/°C
V _{IN}	Input Voltage Required to Maintain Line Regulation	T _J = 25°C, I _O ≤ 1A	7.5			14.6			17.7			V

**LM7808C
Electrical Characteristics**
 $0^{\circ}\text{C} \leq T_J \leq +150^{\circ}\text{C}$, V_I = 14V, I_O = 500 mA, C_I = 0.33 μF, C_O = 0.1 μF, unless otherwise specified

Symbol	Parameter		Conditions ⁽¹⁾	LM7808C			Units
				Min	Typ	Max	
V _O	Output Voltage		T _J = 25°C	7.7	8.0	8.3	V
ΔV _O	Line Regulation		T _J = 25°C	10.5V ≤ V _I ≤ 25V	6.0	160	mV
				11.0V ≤ V _I ≤ 17V	2.0	80	
ΔV _O	Load Regulation		T _J = 25°C	5.0 mA ≤ I _O ≤ 1.5A	12	160	mV
				250 mA ≤ I _O ≤ 750 mA	4.0	80	
V _O	Output Voltage		11.5V ≤ V _I ≤ 23V, 5.0 mA ≤ I _O ≤ 1.0A, P ≤ 15W	7.6		8.4	V
I _Q	Quiescent Current		T _J = 25°C		4.3	8.0	mA
ΔI _Q	Quiescent Current Change	With Line	11.5V ≤ V _I ≤ 25V			1.0	mA
		With Load	5.0 mA ≤ I _O ≤ 1.0A			0.5	
V _N	Noise		T _A = 25°C, 10 Hz ≤ f ≤ 100 kHz		52		μV
ΔV _I /ΔV _O	Ripple Rejection		f = 120 Hz, I _O = 350 mA, T _J = 25°C	56	72		dB
V _{DO}	Dropout Voltage		I _O = 1.0A, T _J = 25°C		2.0		V
R _O	Output Resistance		f = 1.0 kHz		16		mΩ
I _{OS}	Output Short Circuit Current		T _J = 25°C, V _I = 35V		0.45		A
I _{PK}	Peak Output Current		T _J = 25°C		2.2		A
ΔV _O /ΔT	Average Temperature Coefficient of Output Voltage		I _O = 5.0 mA		0.8		mV/°C

- (1) All characteristics are measured with a 0.22 μF capacitor from input to ground and a 0.1 μF capacitor from output to ground. All characteristics except noise voltage and ripple rejection ratio are measured using pulse techniques (t_w ≤ 10 ms, duty cycle ≤ 5%). Output voltage changes due to changes in internal temperature must be taken into account separately.

Typical Performance Characteristics

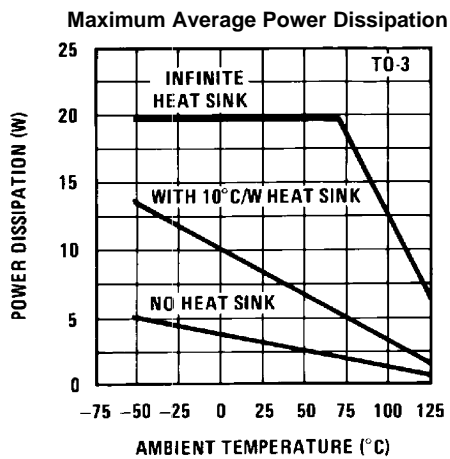

Figure 7.

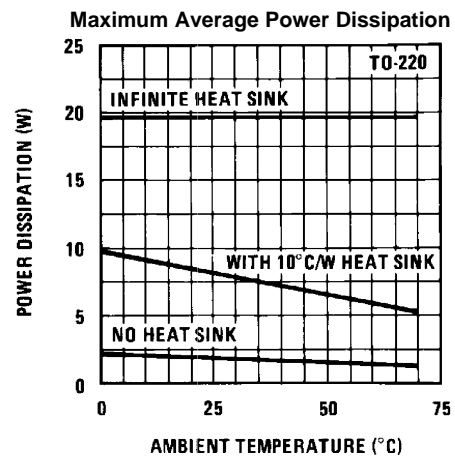

Figure 8.

Maximum Power Dissipation (DDPAK/TO-263)
(See Note 2)

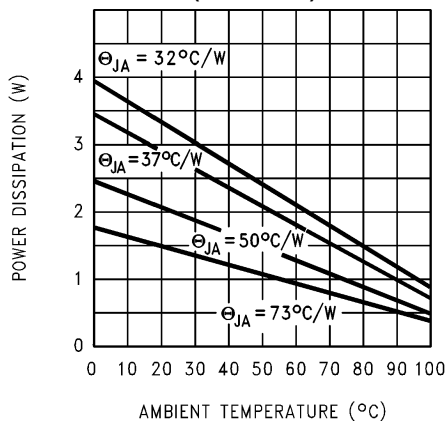
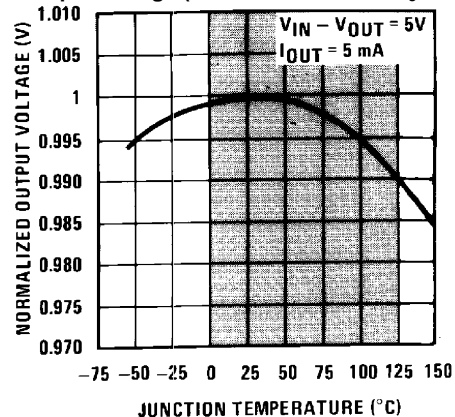

Figure 9.

Output Voltage (Normalized to 1V at T_J = 25°C)



Shaded area refers to LM340A/LM340-N, LM7805C, LM7812C and LM7815C.

Figure 10.

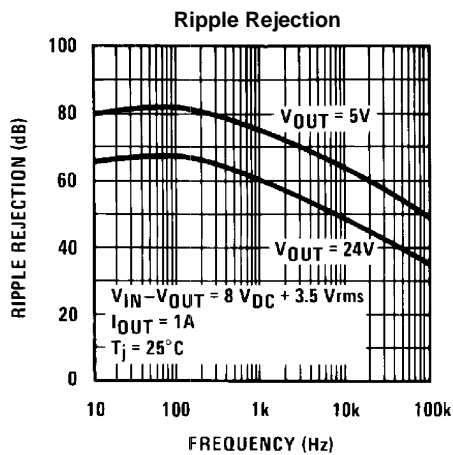

Figure 11.

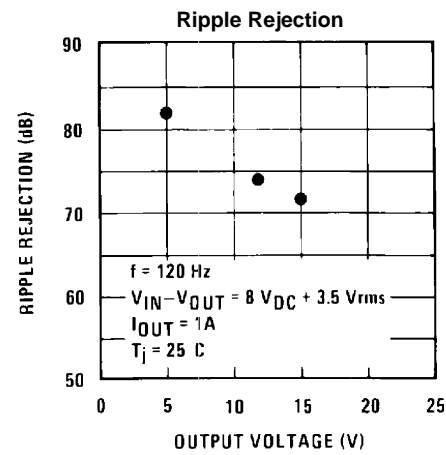

Figure 12.

Typical Performance Characteristics (continued)

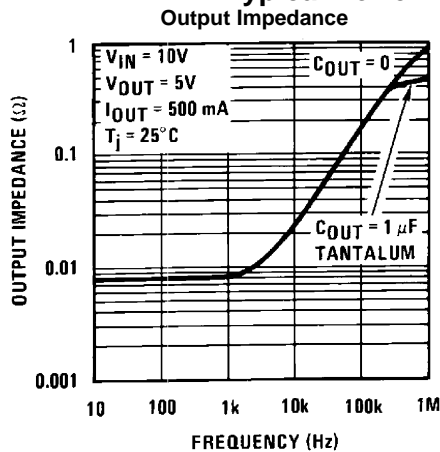

Figure 13.

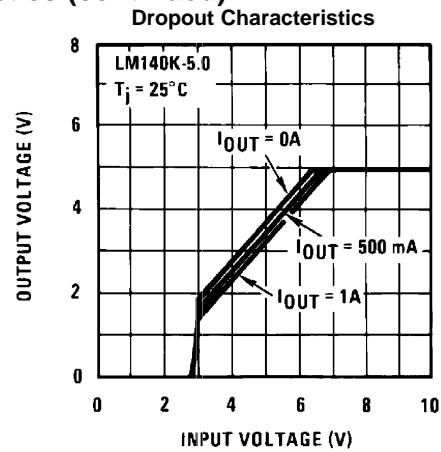
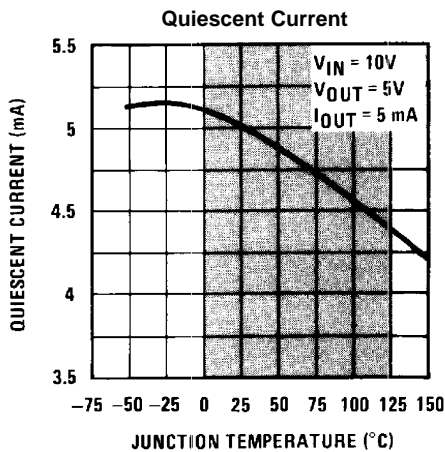

Figure 14.



Shaded area refers to LM340A/LM340-N, LM7805C, LM7812C and LM7815C.

Figure 15.

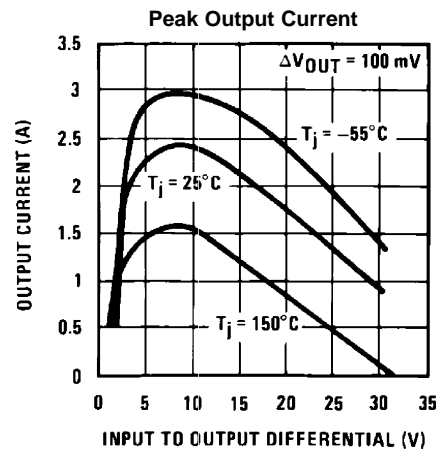
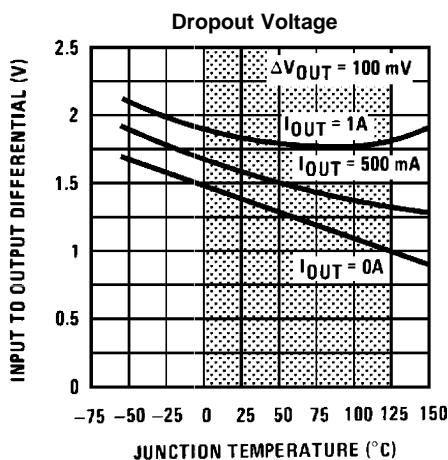

Figure 16.



Shaded area refers to LM340A/LM340-N, LM7805C, LM7812C and LM7815C.

Figure 17.

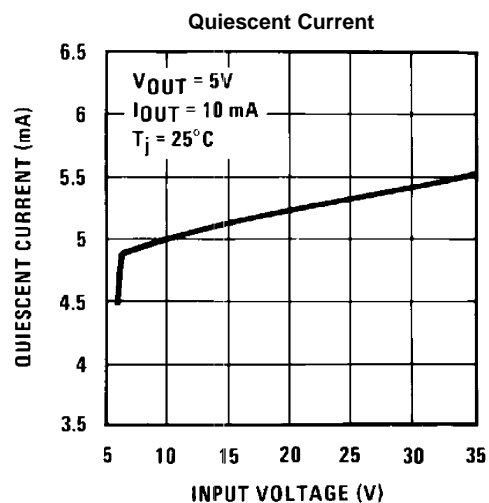

Figure 18.

Typical Performance Characteristics (continued)

Line Regulation
140AK-5.0, I_{OUT} = 1A, T_A = 25°C

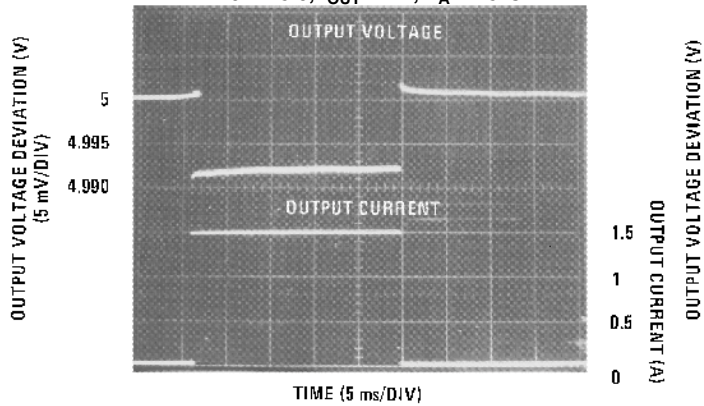

Figure 19.

Line Regulation
140AK-5.0, V_{IN} = 10V, T_A = 25°C

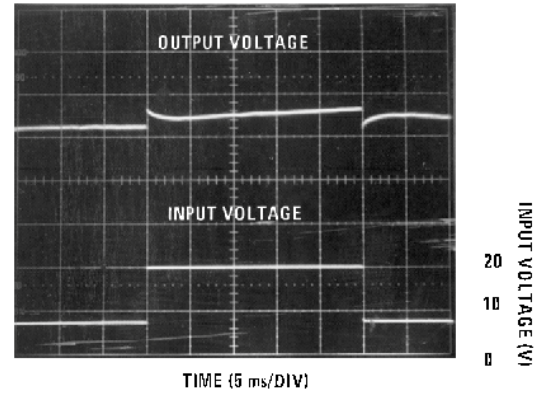
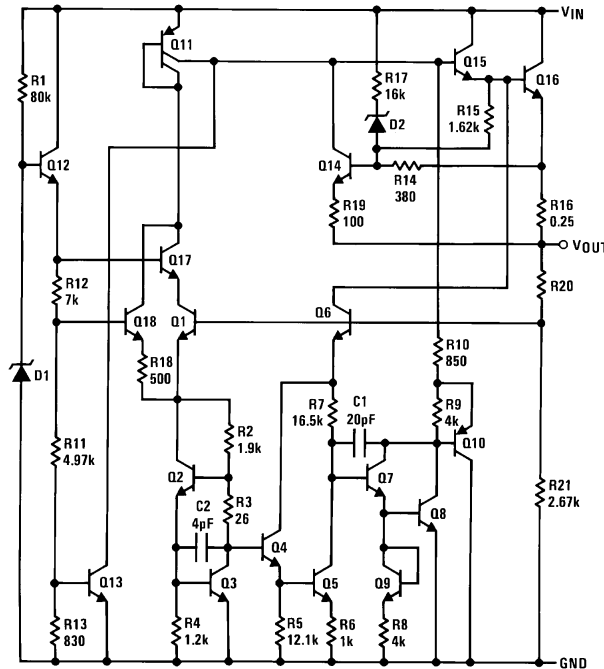

Figure 20.

Equivalent Schematic



APPLICATION HINTS

The LM340-N/LM78XX series is designed with thermal protection, output short-circuit protection and output transistor safe area protection. However, as with *any* IC regulator, it becomes necessary to take precautions to assure that the regulator is not inadvertently damaged. The following describes possible misapplications and methods to prevent damage to the regulator.

SHORTING THE REGULATOR INPUT

When using large capacitors at the output of these regulators, a protection diode connected input to output (Figure 21) may be required if the input is shorted to ground. Without the protection diode, an input short will cause the input to rapidly approach ground potential, while the output remains near the initial V_{OUT} because of the stored charge in the large output capacitor. The capacitor will then discharge through a large internal input to output diode and parasitic transistors. If the energy released by the capacitor is large enough, this diode, low current metal and the regulator will be destroyed. The fast diode in Figure 21 will shunt most of the capacitors discharge current around the regulator. Generally no protection diode is required for values of output capacitance $\leq 10 \mu\text{F}$.

RAISING THE OUTPUT VOLTAGE ABOVE THE INPUT VOLTAGE

Since the output of the device does not sink current, forcing the output high can cause damage to internal low current paths in a manner similar to that just described in the “Shorting the Regulator Input” section.

REGULATOR FLOATING GROUND (Figure 22)

When the ground pin alone becomes disconnected, the output approaches the unregulated input, causing possible damage to other circuits connected to V_{OUT} . If ground is reconnected with power “ON”, damage may also occur to the regulator. This fault is most likely to occur when plugging in regulators or modules with on card regulators into powered up sockets. Power should be turned off first, thermal limit ceases operating, or ground should be connected first if power must be left on.

TRANSIENT VOLTAGES

If transients exceed the maximum rated input voltage of the device, or reach more than 0.8V below ground and have sufficient energy, they will damage the regulator. The solution is to use a large input capacitor, a series input breakdown diode, a choke, a transient suppressor or a combination of these.

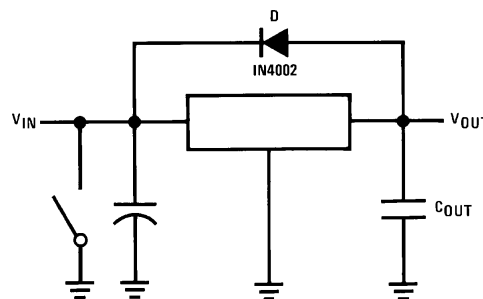

Figure 21. Input Short

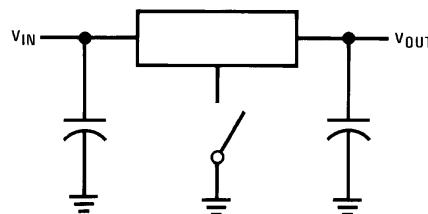

Figure 22. Regulator Floating Ground

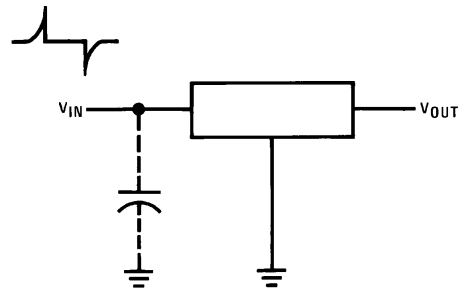

Figure 23. Transients

When a value for $\theta_{(H-A)}$ is found using the equation shown, a heatsink must be selected that has a value that is less than or equal to this number.

$\theta_{(H-A)}$ is specified numerically by the heatsink manufacturer in this catalog, or shown in a curve that plots temperature rise vs power dissipation for the heatsink.

HEATSINKING DDPAK/TO-263 AND SOT-223 PACKAGE PARTS

Both the DDPAK/TO-263 (KTT) and SOT-223 (DCY) packages use a copper plane on the PCB and the PCB itself as a heatsink. To optimize the heat sinking ability of the plane and PCB, solder the tab of the plane.

shows for the DDPAK/TO-263 the measured values of $\theta_{(J-A)}$ for different copper area sizes using a typical PCB with 1 ounce copper and no solder mask over the copper area used for heatsinking.

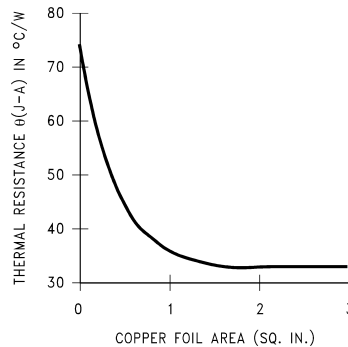

Figure 24. $\theta_{(J-A)}$ vs Copper (1 ounce) Area for the DDPAK/TO-263 Package

As shown in the figure, increasing the copper area beyond 1 square inch produces very little improvement. It should also be observed that the minimum value of $\theta_{(J-A)}$ for the DDPAK/TO-263 package mounted to a PCB is 32°C/W.

As a design aid, [Figure 25](#) shows the maximum allowable power dissipation compared to ambient temperature for the DDPAK/TO-263 device (assuming $\theta_{(J-A)}$ is 35°C/W and the maximum junction temperature is 125°C).

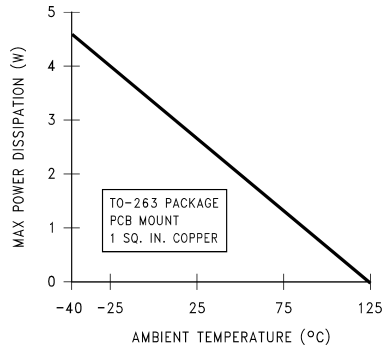

Figure 25. Maximum Power Dissipation vs T_{AMB} for the DPAK/TO-263 Package

Figure 26 and Figure 27 show the information for the SOT-223 package. Figure 26 assumes a $\theta_{(J-A)}$ of 74°C/W for 1 ounce copper and 51°C/W for 2 ounce copper and a maximum junction temperature of 125°C.

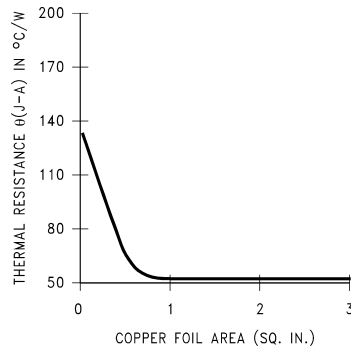

Figure 26. $\theta_{(J-A)}$ vs Copper (2 ounce) Area for the SOT-223 Package

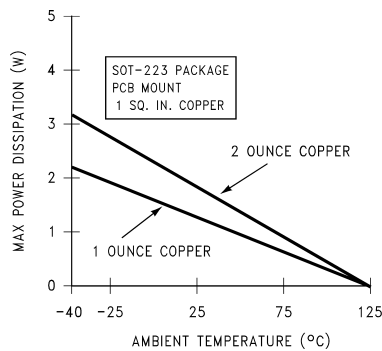
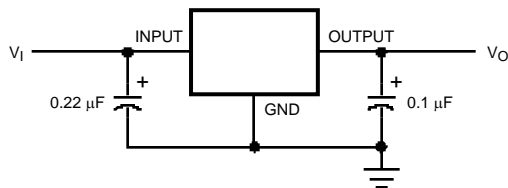

Figure 27. Maximum Power Dissipation vs T_{AMB} for the SOT-223 Package

Please see AN-1028 (SNVA036) for power enhancement techniques to be used with the SOT-223 package.

Typical Applications



Bypass capacitors are recommended for optimum stability and transient response, and should be located as close as possible to the regulator.

Figure 28. Fixed Output Regulator

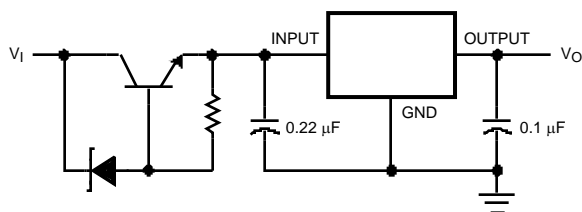
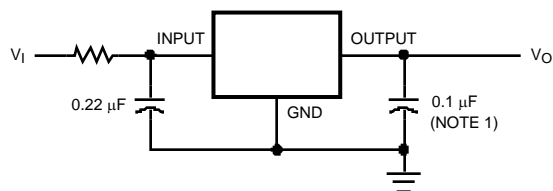
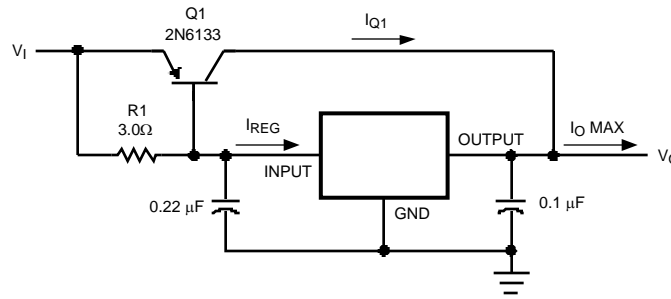

Figure 29. High Input Voltage Circuits



$$\beta(Q1) \geq \frac{I_{O \text{ Max}}}{I_{REG \text{ Max}}}$$

$$R1 = \frac{0.9}{I_{REG}} = \frac{\beta(Q1) V_{BE}(Q1)}{I_{REG \text{ Max}} (\beta + 1) - I_{O \text{ Max}}}$$

Figure 30. High Current Voltage Regulator

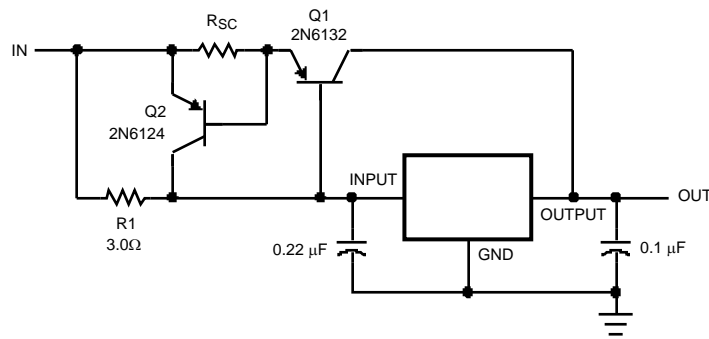

$$R_{SC} = \frac{0.8}{I_{SC}}$$

$$R1 = \frac{\beta V_{BE}(Q1)}{I_{REG \text{ Max}} (\beta + 1) - I_{O \text{ Max}}}$$

Figure 31. High Output Current, Short Circuit Protected

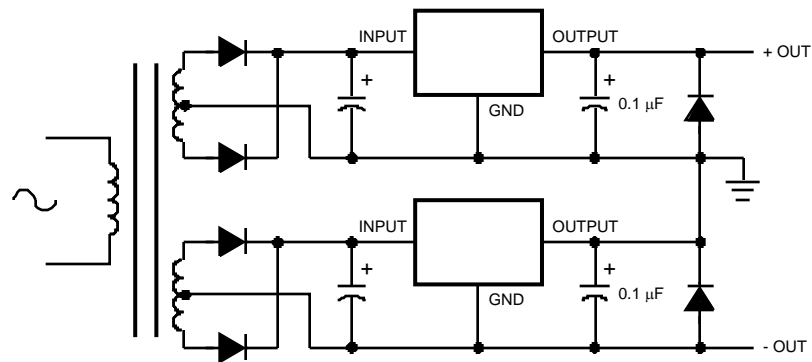

Figure 32. Positive and Negative Regulator

REVISION HISTORY

Changes from Revision H (March 2013) to Revision I	Page
<hr/> <ul style="list-style-type: none">• Changed layout of National Data Sheet to TI format	<hr/> 16

PACKAGING INFORMATION

Orderable Device	Status (1)	Package Type	Package Drawing	Pins	Package Qty	Eco Plan (2)	Lead/Ball Finish	MSL Peak Temp (3)	Op Temp (°C)	Top-Side Markings (4)	Samples
LM340AT-5.0	ACTIVE	TO-220	NDE	3	45	TBD	Call TI	Call TI	0 to 70	LM340AT 5.0 P+	Samples
LM340AT-5.0/NOPB	ACTIVE	TO-220	NDE	3	45	Pb-Free (RoHS Exempt)	CU SN	Level-1-NA-UNLIM	0 to 70	LM340AT 5.0 P+	Samples
LM340K-5.0	ACTIVE	TO-3	NDS	2	50	TBD	Call TI	Call TI	0 to 70	LM340K -5.0 7805P+	Samples
LM340K-5.0/NOPB	ACTIVE	TO-3	NDS	2	50	Green (RoHS & no Sb/Br)	POST-PLATE	Level-1-NA-UNLIM	0 to 70	LM340K -5.0 7805P+	Samples
LM340MP-5.0	ACTIVE	SOT-223	DCY	4	1000	TBD	Call TI	Call TI	0 to 70	N00A	Samples
LM340MP-5.0/NOPB	ACTIVE	SOT-223	DCY	4	1000	Green (RoHS & no Sb/Br)	CU SN	Level-1-260C-UNLIM	0 to 70	N00A	Samples
LM340MPX-5.0/NOPB	ACTIVE	SOT-223	DCY	4	2000	Green (RoHS & no Sb/Br)	CU SN	Level-1-260C-UNLIM	0 to 70	N00A	Samples
LM340S-12/NOPB	ACTIVE	DDPAK/ TO-263	KTT	3	45	Pb-Free (RoHS Exempt)	CU SN	Level-3-245C-168 HR	0 to 70	LM340S -12 P+	Samples
LM340S-5.0	ACTIVE	DDPAK/ TO-263	KTT	3	45	TBD	Call TI	Call TI	0 to 70	LM340S -5.0 P+	Samples
LM340S-5.0/NOPB	ACTIVE	DDPAK/ TO-263	KTT	3	45	Pb-Free (RoHS Exempt)	CU SN	Level-3-245C-168 HR	0 to 70	LM340S -5.0 P+	Samples
LM340SX-12	ACTIVE	DDPAK/ TO-263	KTT	3	500	TBD	Call TI	Call TI	0 to 70	LM340S -12 P+	Samples
LM340SX-12/NOPB	ACTIVE	DDPAK/ TO-263	KTT	3	500	Pb-Free (RoHS Exempt)	CU SN	Level-3-245C-168 HR	0 to 70	LM340S -12 P+	Samples
LM340SX-5.0	ACTIVE	DDPAK/ TO-263	KTT	3	500	TBD	Call TI	Call TI	0 to 70	LM340S -5.0 P+	Samples
LM340SX-5.0/NOPB	ACTIVE	DDPAK/ TO-263	KTT	3	500	Pb-Free (RoHS Exempt)	CU SN	Level-3-245C-168 HR	0 to 70	LM340S -5.0 P+	Samples
LM340T-12	ACTIVE	TO-220	NDE	3	45	TBD	Call TI	Call TI	0 to 70	LM340T12 7812 P+	Samples
LM340T-12/NOPB	ACTIVE	TO-220	NDE	3	45	Green (RoHS & no Sb/Br)	CU SN	Level-1-NA-UNLIM	0 to 70	LM340T12 7812 P+	Samples
LM340T-15	ACTIVE	TO-220	NDE	3	45	TBD	Call TI	Call TI	0 to 70	LM340T15 7815 P+	Samples

Orderable Device	Status (1)	Package Type	Package Drawing	Pins	Package Qty	Eco Plan (2)	Lead/Ball Finish	MSL Peak Temp (3)	Op Temp (°C)	Top-Side Markings (4)	Samples
LM340T-15/NOPB	ACTIVE	TO-220	NDE	3	45	Green (RoHS & no Sb/Br)	CU SN	Level-1-NA-UNLIM	0 to 70	LM340T15 7815 P+	Samples
LM340T-5.0	ACTIVE	TO-220	NDE	3	45	TBD	Call TI	Call TI	0 to 70	LM340T5 7805 P+	Samples
LM340T-5.0/LB01	ACTIVE	TO-220	NDG	3	45	TBD	Call TI	Call TI		LM340T5 7805 P+	Samples
LM340T-5.0/LF01	ACTIVE	TO-220	NDG	3	45	Pb-Free (RoHS Exempt)	CU SN	Level-4-260C-72 HR		LM340T5 7805 P+	Samples
LM340T-5.0/NOPB	ACTIVE	TO-220	NDE	3	45	Pb-Free (RoHS Exempt)	CU SN	Level-1-NA-UNLIM	0 to 70	LM340T5 7805 P+	Samples
LM7812CT	ACTIVE	TO-220	NDE	3	45	TBD	Call TI	Call TI	0 to 70	LM340T12 7812 P+	Samples
LM7812CT/NOPB	ACTIVE	TO-220	NDE	3	45	Green (RoHS & no Sb/Br)	CU SN	Level-1-NA-UNLIM	0 to 70	LM340T12 7812 P+	Samples

(1) The marketing status values are defined as follows:

ACTIVE: Product device recommended for new designs.

LIFEBUY: TI has announced that the device will be discontinued, and a lifetime-buy period is in effect.

NRND: Not recommended for new designs. Device is in production to support existing customers, but TI does not recommend using this part in a new design.

PREVIEW: Device has been announced but is not in production. Samples may or may not be available.

OBSOLETE: TI has discontinued the production of the device.

(2) Eco Plan - The planned eco-friendly classification: Pb-Free (RoHS), Pb-Free (RoHS Exempt), or Green (RoHS & no Sb/Br) - please check <http://www.ti.com/productcontent> for the latest availability information and additional product content details.

TBD: The Pb-Free/Green conversion plan has not been defined.

Pb-Free (RoHS): TI's terms "Lead-Free" or "Pb-Free" mean semiconductor products that are compatible with the current RoHS requirements for all 6 substances, including the requirement that lead not exceed 0.1% by weight in homogeneous materials. Where designed to be soldered at high temperatures, TI Pb-Free products are suitable for use in specified lead-free processes.

Pb-Free (RoHS Exempt): This component has a RoHS exemption for either 1) lead-based flip-chip solder bumps used between the die and package, or 2) lead-based die adhesive used between the die and leadframe. The component is otherwise considered Pb-Free (RoHS compatible) as defined above.

Green (RoHS & no Sb/Br): TI defines "Green" to mean Pb-Free (RoHS compatible), and free of Bromine (Br) and Antimony (Sb) based flame retardants (Br or Sb do not exceed 0.1% by weight in homogeneous material)

(3) MSL, Peak Temp. -- The Moisture Sensitivity Level rating according to the JEDEC industry standard classifications, and peak solder temperature.

(4) Only one of markings shown within the brackets will appear on the physical device.

Important Information and Disclaimer: The information provided on this page represents TI's knowledge and belief as of the date that it is provided. TI bases its knowledge and belief on information provided by third parties, and makes no representation or warranty as to the accuracy of such information. Efforts are underway to better integrate information from third parties. TI has taken and

continues to take reasonable steps to provide representative and accurate information but may not have conducted destructive testing or chemical analysis on incoming materials and chemicals. TI and TI suppliers consider certain information to be proprietary, and thus CAS numbers and other limited information may not be available for release.

In no event shall TI's liability arising out of such information exceed the total purchase price of the TI part(s) at issue in this document sold by TI to Customer on an annual basis.

TAPE AND REEL INFORMATION

QUADRANT ASSIGNMENTS FOR PIN 1 ORIENTATION IN TAPE

*All dimensions are nominal

Device	Package Type	Package Drawing	Pins	SPQ	Reel Diameter (mm)	Reel Width W1 (mm)	A0 (mm)	B0 (mm)	K0 (mm)	P1 (mm)	W (mm)	Pin1 Quadrant
LM340MP-5.0	SOT-223	DCY	4	1000	330.0	16.4	7.0	7.5	2.2	12.0	16.0	Q3
LM340MP-5.0/NOPB	SOT-223	DCY	4	1000	330.0	16.4	7.0	7.5	2.2	12.0	16.0	Q3
LM340MPX-5.0/NOPB	SOT-223	DCY	4	2000	330.0	16.4	7.0	7.5	2.2	12.0	16.0	Q3
LM340SX-12	DDPAK/ TO-263	KTT	3	500	330.0	24.4	10.75	14.85	5.0	16.0	24.0	Q2
LM340SX-12/NOPB	DDPAK/ TO-263	KTT	3	500	330.0	24.4	10.75	14.85	5.0	16.0	24.0	Q2
LM340SX-5.0	DDPAK/ TO-263	KTT	3	500	330.0	24.4	10.75	14.85	5.0	16.0	24.0	Q2
LM340SX-5.0/NOPB	DDPAK/ TO-263	KTT	3	500	330.0	24.4	10.75	14.85	5.0	16.0	24.0	Q2

TAPE AND REEL BOX DIMENSIONS



*All dimensions are nominal

Device	Package Type	Package Drawing	Pins	SPQ	Length (mm)	Width (mm)	Height (mm)
LM340MP-5.0	SOT-223	DCY	4	1000	349.0	337.0	45.0
LM340MP-5.0/NOPB	SOT-223	DCY	4	1000	349.0	337.0	45.0
LM340MPX-5.0/NOPB	SOT-223	DCY	4	2000	354.0	340.0	35.0
LM340SX-12	DDPAK/TO-263	KTT	3	500	358.0	343.0	63.0
LM340SX-12/NOPB	DDPAK/TO-263	KTT	3	500	358.0	343.0	63.0
LM340SX-5.0	DDPAK/TO-263	KTT	3	500	358.0	343.0	63.0
LM340SX-5.0/NOPB	DDPAK/TO-263	KTT	3	500	358.0	343.0	63.0

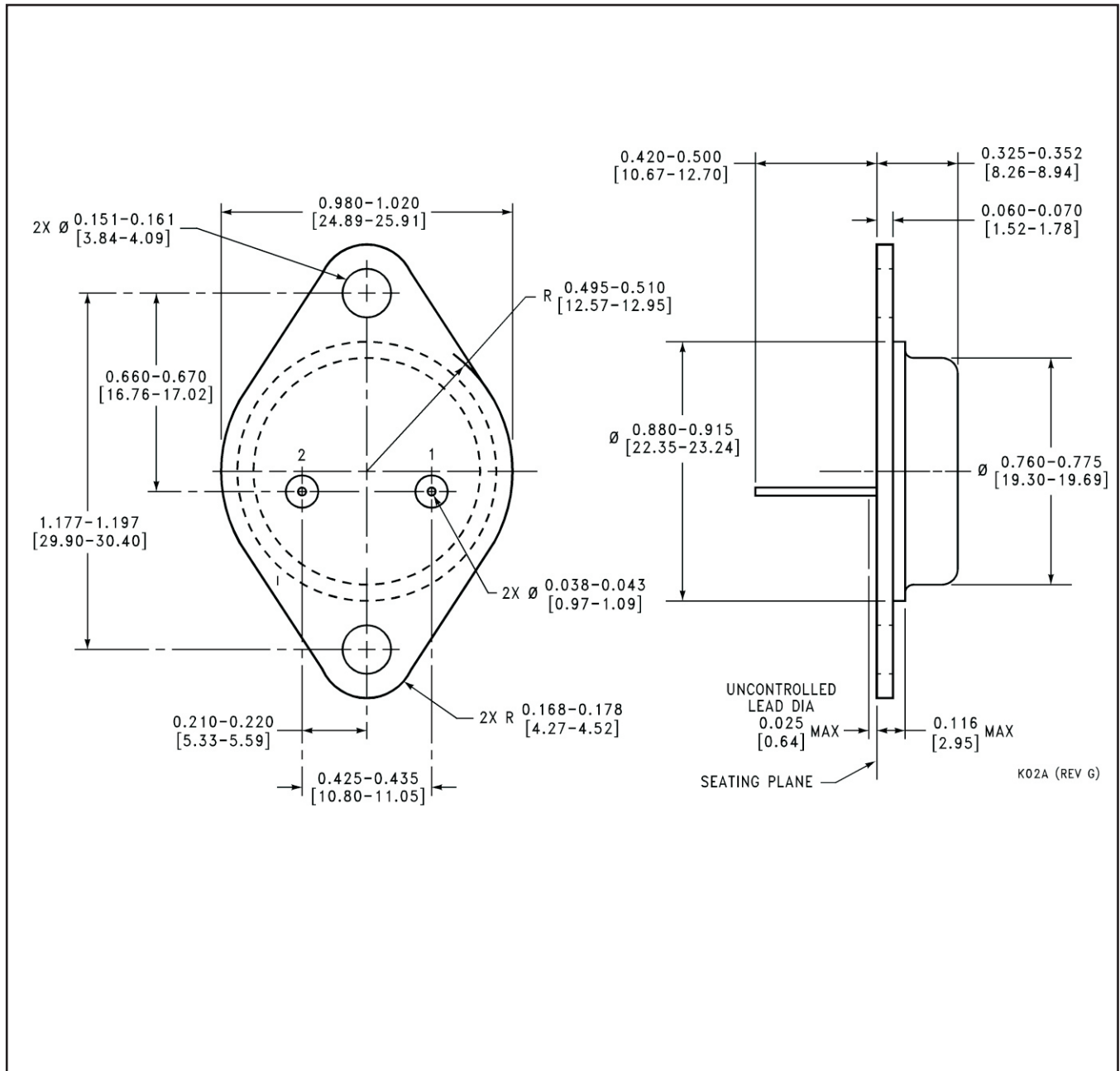
NDS0002A

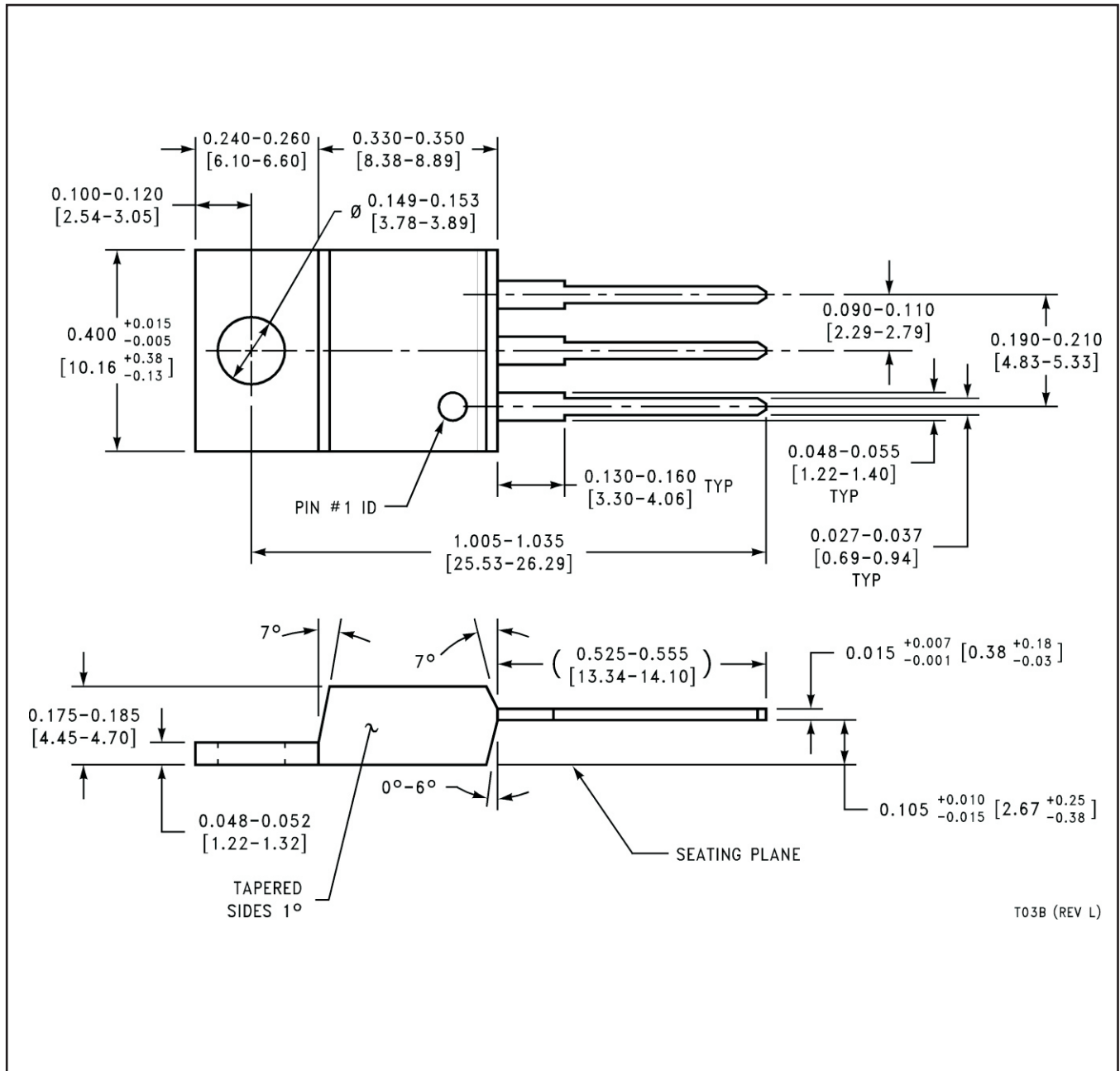

NDE0003B



DCY (R-PDSO-G4)

PLASTIC SMALL-OUTLINE

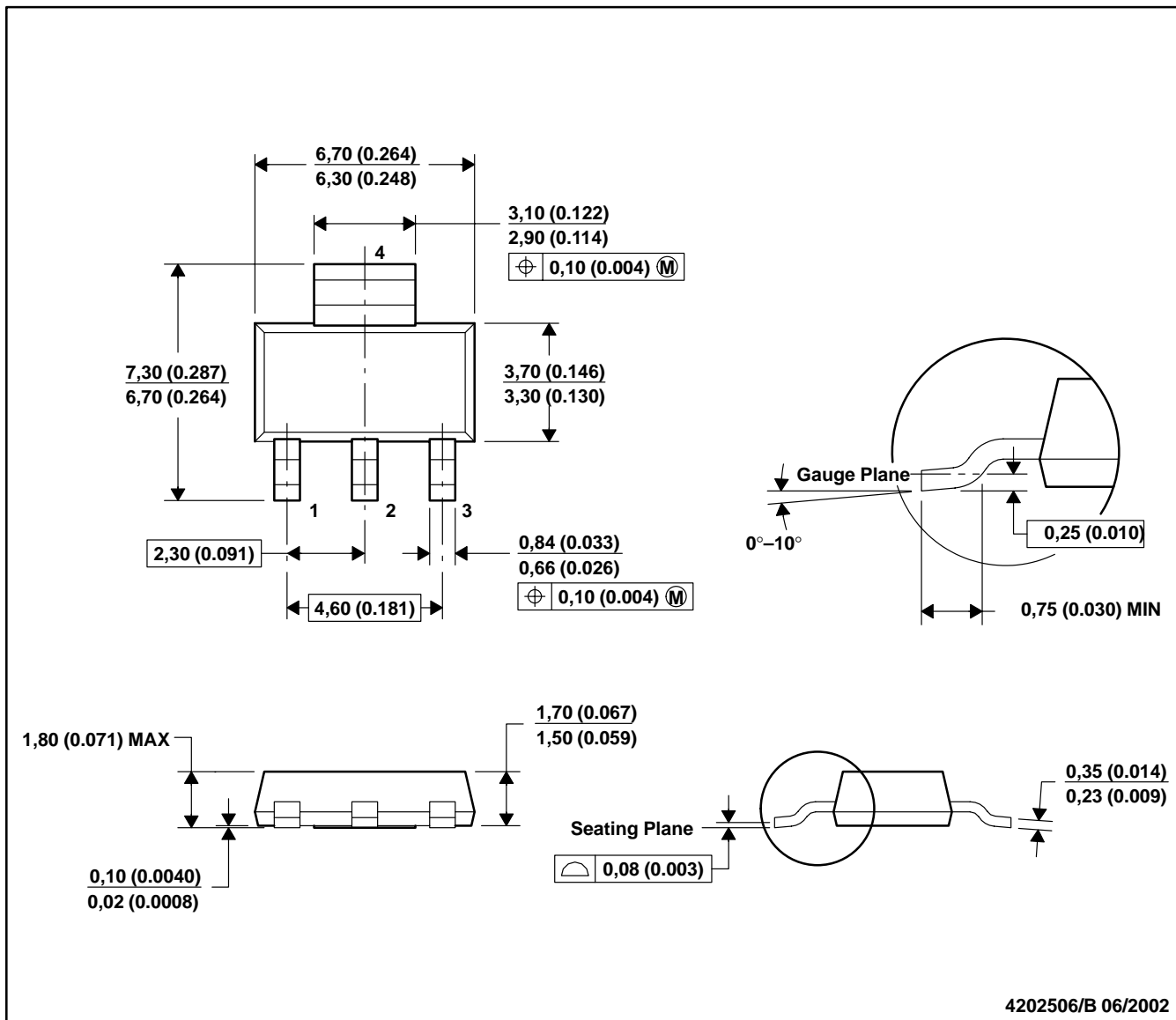

- NOTES: A. All linear dimensions are in millimeters (inches).
 B. This drawing is subject to change without notice.
 C. Body dimensions do not include mold flash or protrusion.
 D. Falls within JEDEC TO-261 Variation AA.

KTT0003B

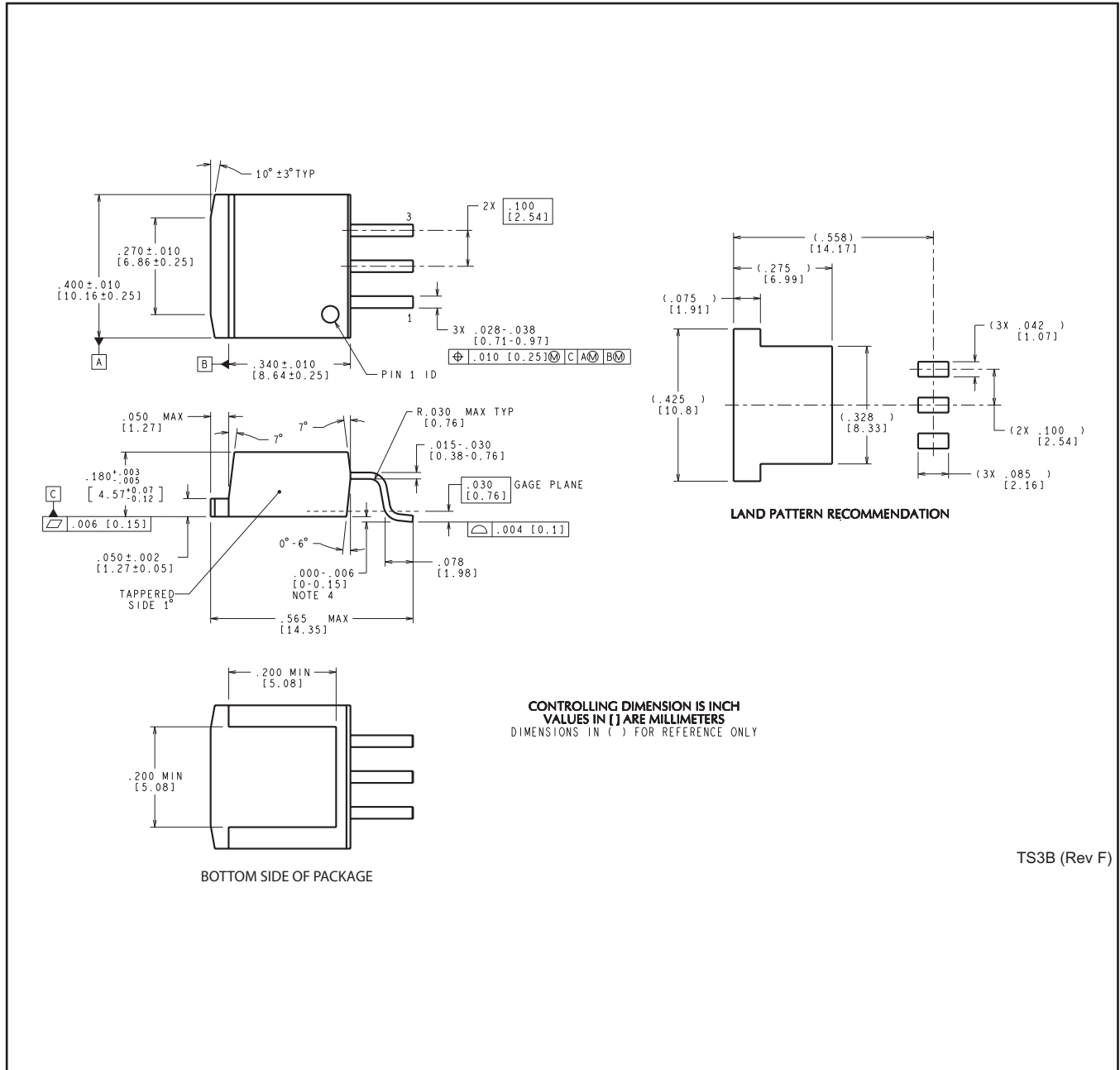

TS3B (Rev F)

IMPORTANT NOTICE

Texas Instruments Incorporated and its subsidiaries (TI) reserve the right to make corrections, enhancements, improvements and other changes to its semiconductor products and services per JESD46, latest issue, and to discontinue any product or service per JESD48, latest issue. Buyers should obtain the latest relevant information before placing orders and should verify that such information is current and complete. All semiconductor products (also referred to herein as "components") are sold subject to TI's terms and conditions of sale supplied at the time of order acknowledgment.

TI warrants performance of its components to the specifications applicable at the time of sale, in accordance with the warranty in TI's terms and conditions of sale of semiconductor products. Testing and other quality control techniques are used to the extent TI deems necessary to support this warranty. Except where mandated by applicable law, testing of all parameters of each component is not necessarily performed.

TI assumes no liability for applications assistance or the design of Buyers' products. Buyers are responsible for their products and applications using TI components. To minimize the risks associated with Buyers' products and applications, Buyers should provide adequate design and operating safeguards.

TI does not warrant or represent that any license, either express or implied, is granted under any patent right, copyright, mask work right, or other intellectual property right relating to any combination, machine, or process in which TI components or services are used. Information published by TI regarding third-party products or services does not constitute a license to use such products or services or a warranty or endorsement thereof. Use of such information may require a license from a third party under the patents or other intellectual property of the third party, or a license from TI under the patents or other intellectual property of TI.

Reproduction of significant portions of TI information in TI data books or data sheets is permissible only if reproduction is without alteration and is accompanied by all associated warranties, conditions, limitations, and notices. TI is not responsible or liable for such altered documentation. Information of third parties may be subject to additional restrictions.

Resale of TI components or services with statements different from or beyond the parameters stated by TI for that component or service voids all express and any implied warranties for the associated TI component or service and is an unfair and deceptive business practice. TI is not responsible or liable for any such statements.

Buyer acknowledges and agrees that it is solely responsible for compliance with all legal, regulatory and safety-related requirements concerning its products, and any use of TI components in its applications, notwithstanding any applications-related information or support that may be provided by TI. Buyer represents and agrees that it has all the necessary expertise to create and implement safeguards which anticipate dangerous consequences of failures, monitor failures and their consequences, lessen the likelihood of failures that might cause harm and take appropriate remedial actions. Buyer will fully indemnify TI and its representatives against any damages arising out of the use of any TI components in safety-critical applications.

In some cases, TI components may be promoted specifically to facilitate safety-related applications. With such components, TI's goal is to help enable customers to design and create their own end-product solutions that meet applicable functional safety standards and requirements. Nonetheless, such components are subject to these terms.

No TI components are authorized for use in FDA Class III (or similar life-critical medical equipment) unless authorized officers of the parties have executed a special agreement specifically governing such use.

Only those TI components which TI has specifically designated as military grade or "enhanced plastic" are designed and intended for use in military/aerospace applications or environments. Buyer acknowledges and agrees that any military or aerospace use of TI components which have **not** been so designated is solely at the Buyer's risk, and that Buyer is solely responsible for compliance with all legal and regulatory requirements in connection with such use.

TI has specifically designated certain components as meeting ISO/TS16949 requirements, mainly for automotive use. In any case of use of non-designated products, TI will not be responsible for any failure to meet ISO/TS16949.

Products

Audio	www.ti.com/audio
Amplifiers	amplifier.ti.com
Data Converters	dataconverter.ti.com
DLP® Products	www.dlp.com
DSP	dsp.ti.com
Clocks and Timers	www.ti.com/clocks
Interface	interface.ti.com
Logic	logic.ti.com
Power Mgmt	power.ti.com
Microcontrollers	microcontroller.ti.com
RFID	www.ti-rfid.com
OMAP Applications Processors	www.ti.com/omap
Wireless Connectivity	www.ti.com/wirelessconnectivity

Applications

Automotive and Transportation	www.ti.com/automotive
Communications and Telecom	www.ti.com/communications
Computers and Peripherals	www.ti.com/computers
Consumer Electronics	www.ti.com/consumer-apps
Energy and Lighting	www.ti.com/energy
Industrial	www.ti.com/industrial
Medical	www.ti.com/medical
Security	www.ti.com/security
Space, Avionics and Defense	www.ti.com/space-avionics-defense
Video and Imaging	www.ti.com/video

TI E2E Community

e2e.ti.com