

LM317M

3-TERMINAL ADJUSTABLE REGULATOR

SLVS297K – APRIL 2000 – REVISED NOVEMBER 2003

- Output Voltage Range Adjustable From 1.25 V to 37 V
- Output Current Greater Than 500 mA
- Internal Short-Circuit Current Limiting
- Thermal-Overload Protection
- Output Safe-Area Compensation
- Q Devices Meet Automotive Performance Requirements
- Customer-Specific Configuration Control Can Be Supported for Q Devices Along With Major-Change Approval

description/ordering information

The LM317M is an adjustable 3-terminal positive-voltage regulator capable of supplying more than 500 mA over an output-voltage range of 1.25 V to 37 V. The LM317M is exceptionally easy to use and requires only two external resistors to set the output voltage. Furthermore, both line and load regulation are better than standard fixed regulators.

In addition to having higher performance than fixed regulators, the device includes on-chip current limiting, thermal-overload protection, and safe-operating-area protection. All overload protection remains fully functional if the ADJUST terminal is disconnected.

Normally, no capacitors are needed unless the device is more than 6 inches from the input filter capacitors, in which case an input bypass capacitor is needed. An optional output capacitor can be added to improve transient response. The ADJUST terminal can be bypassed to achieve very high ripple-rejection ratios, which are difficult to achieve with standard three-terminal regulators.

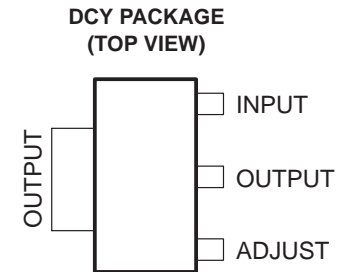
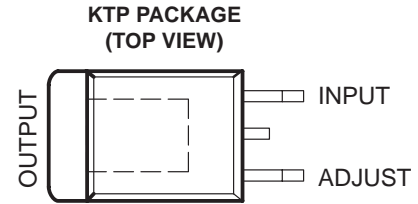

ORDERING INFORMATION

T _J	PACKAGE†		ORDERABLE PART NUMBER	TOP-SIDE MARKING
0°C to 125°C	POWER-FLEX (KTP)	Reel of 2000	LM317MKTTPR	LM317M
	SOT (DCY)	Tube of 80	LM317MDCY	L4
		Reel of 2500	LM317MDCYR	
-40°C to 125°C	POWER-FLEX (KTP)	Reel of 2000	LM317MQKTTPR	317MQ
	SOT (DCY)	Reel of 2500	LM317MQDCYR	L5

† Package drawings, standard packing quantities, thermal data, symbolization, and PCB design guidelines are available at www.ti.com/sc/package.



Please be aware that an important notice concerning availability, standard warranty, and use in critical applications of Texas Instruments semiconductor products and disclaimers thereto appears at the end of this data sheet.

PRODUCTION DATA information is current as of publication date. Products conform to specifications per the terms of Texas Instruments standard warranty. Production processing does not necessarily include testing of all parameters.

 **TEXAS
INSTRUMENTS**

POST OFFICE BOX 655303 • DALLAS, TEXAS 75265

Copyright © 2003, Texas Instruments Incorporated

LM317M

3-TERMINAL ADJUSTABLE REGULATOR

SLVS297K – APRIL 2000 – REVISED NOVEMBER 2003

absolute maximum ratings over operating temperature range (unless otherwise noted)†

Input-to-output differential voltage, $V_I - V_O$	40 V
Operating virtual junction temperature, T_J	150°C
Lead temperature (within 5 mils of the plastic body for 10 seconds): KTP, DCY packages	260°C
Storage temperature range, T_{stg}	-65°C to 150°C

† Stresses beyond those listed under “absolute maximum ratings” may cause permanent damage to the device. These are stress ratings only, and functional operation of the device at these or any other conditions beyond those indicated under “recommended operating conditions” is not implied. Exposure to absolute-maximum-rated conditions for extended periods may affect device reliability.

package thermal data (see Note 1)

PACKAGE	BOARD	θ_{JC}	θ_{JCB}	θ_{JA}
POWER-FLEX (KTP)	High K, JESD 51-5		3°C/W	28°C/W
SOT-223 (DCY)	High K, JESD 51-7	4°C/W		53°C/W

NOTE 1: Maximum power dissipation is a function of $T_J(\max)$, θ_{JA} , and T_A . The maximum allowable power dissipation at any allowable ambient temperature is $P_D = (T_J(\max) - T_A)/\theta_{JA}$. Operating at the absolute maximum T_J of 150°C can affect reliability.

recommended operating conditions

	MIN	MAX	UNIT
$V_I - V_O$ Input-to-output voltage differential		37	V
I_O Output current		0.5	A
T_J Operating virtual junction temperature	No suffix	0 125	°C
	Q suffix	-40 125	

electrical characteristics over recommended operating virtual-junction temperature range, $V_I - V_O = 5$ V, $I_O = 0.1$ A (unless otherwise noted)

PARAMETER	TEST CONDITIONS‡		MIN	TYP	MAX	UNIT
Line regulation§	$V_I - V_O = 3$ V to 40 V	$T_J = 25^\circ\text{C}$		0.01	0.04	%V
		Full temperature range		0.02	0.07	
Load regulation	$I_O = 10$ mA to 500 mA	$T_J = 25^\circ\text{C}$		0.1	0.5	% V_O
		Full temperature range		0.3	1.5	
ADJUST terminal current				50	100	μA
Change in ADJUST terminal current	$V_I - V_O = 3$ V to 40 V,	$I_O = 10$ mA to 500 mA		0.2	5	μA
Reference voltage	$V_I - V_O = 3$ V to 40 V,	$I_O = 10$ mA to 500 mA	1.2	1.25	1.3	V
Output-voltage temperature stability				0.7%		
Minimum load current to maintain regulation				3.5	10	mA
Maximum output current	$V_I - V_O \leq 15$ V		500	900		mA
	$V_I - V_O = 40$ V, $P_D \leq P_{D(\max)}$	$T_J = 25^\circ\text{C}$	150	250		
RMS output noise voltage (% of V_O)	$f = 10$ Hz to 10 kHz,	$T_J = 25^\circ\text{C}$		0.003		% V_O
Ripple rejection	$V_O = 10$ V, $f = 120$ Hz, $T_J = 25^\circ\text{C}$	$C_{ADJ} = 0$ ¶		65		dB
		$C_{ADJ} = 10$ μF ¶		66	80	
Long-term stability		$T_J = 125^\circ\text{C}$		0.3	1	%/ 1k Hrs

‡ Pulse-testing techniques are used to maintain the junction temperature as close to the ambient temperature as possible.

§ Line voltage regulation is expressed here as the percentage change in output voltage per 1-V change at the input.

¶ C_{ADJ} is connected between the ADJUST terminal and ground.



TYPICAL CHARACTERISTICS

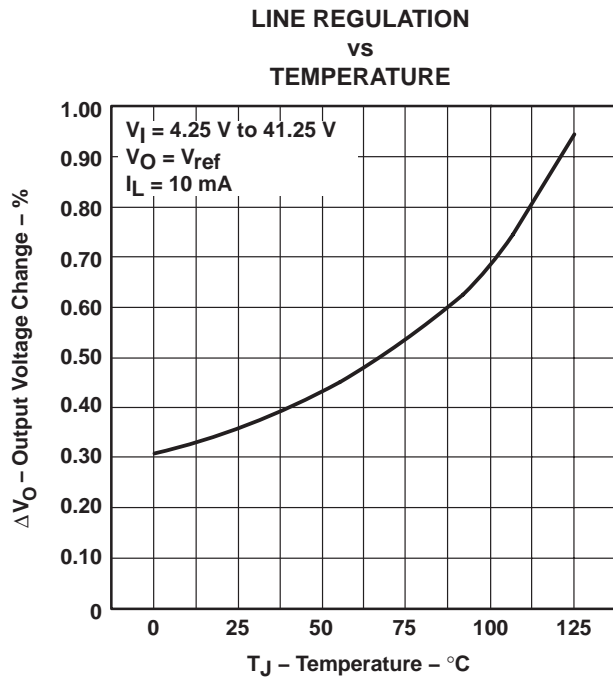

Figure 1

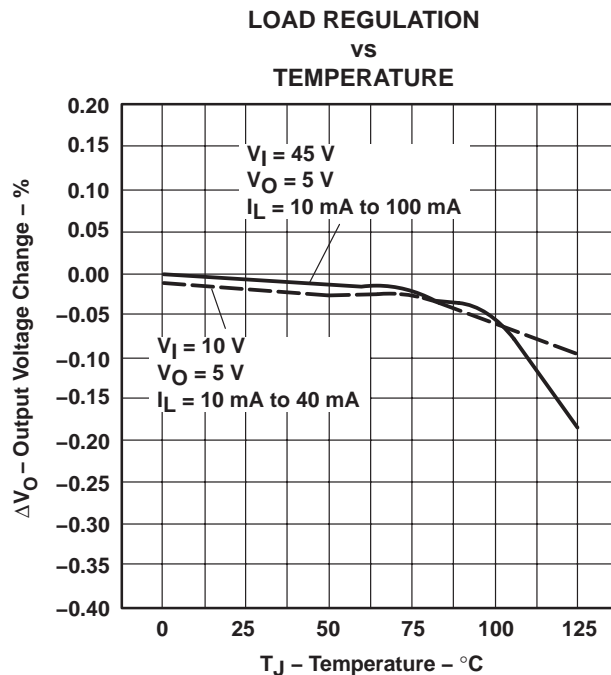

Figure 2

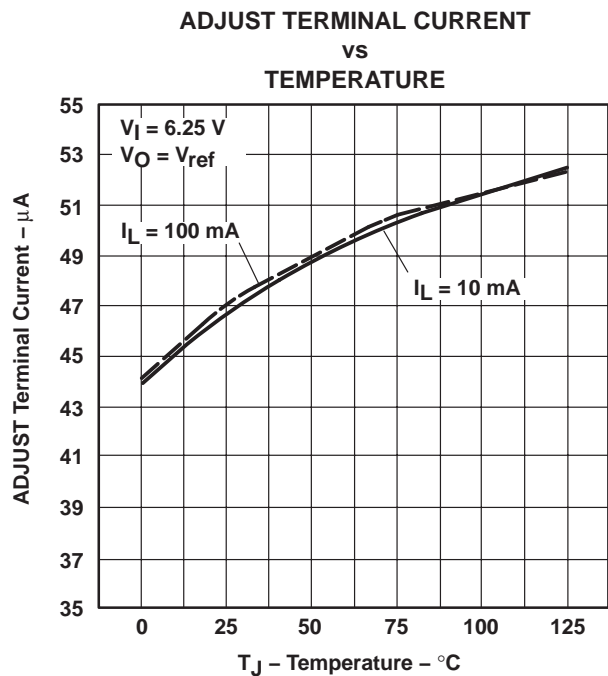

Figure 3

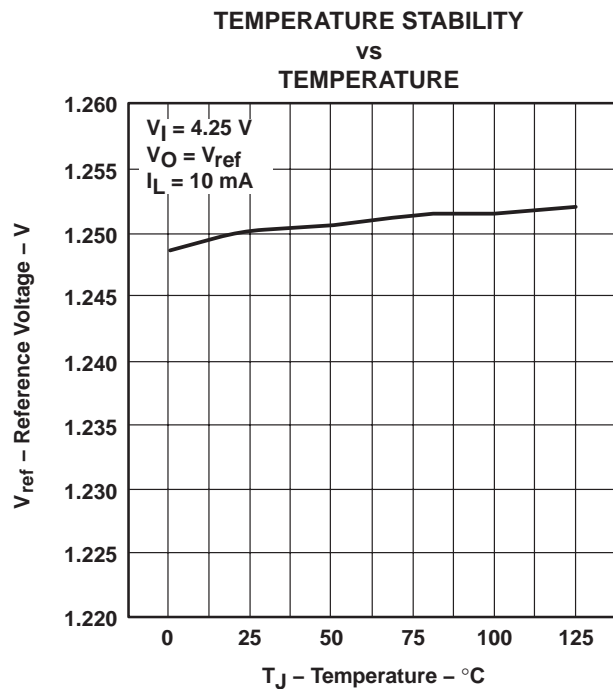

Figure 4

LM317M

3-TERMINAL ADJUSTABLE REGULATOR

SLVS297K – APRIL 2000 – REVISED NOVEMBER 2003

TYPICAL CHARACTERISTICS

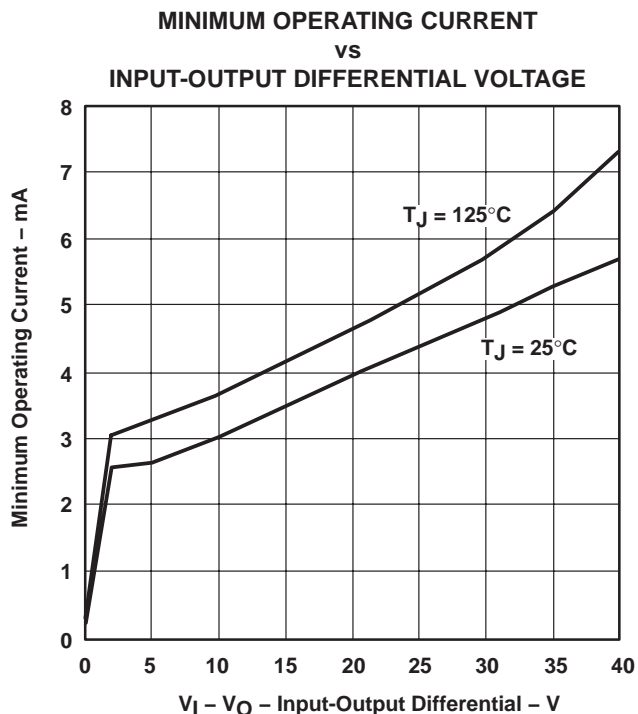

Figure 5

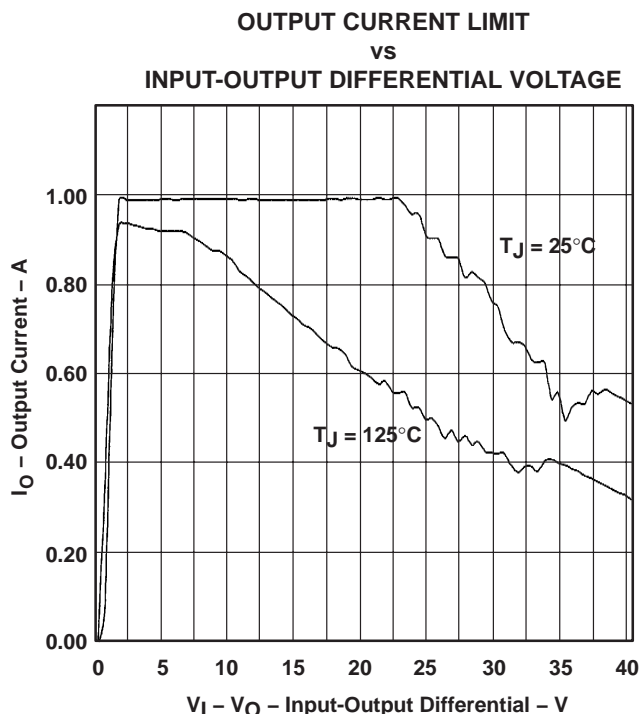

Figure 6

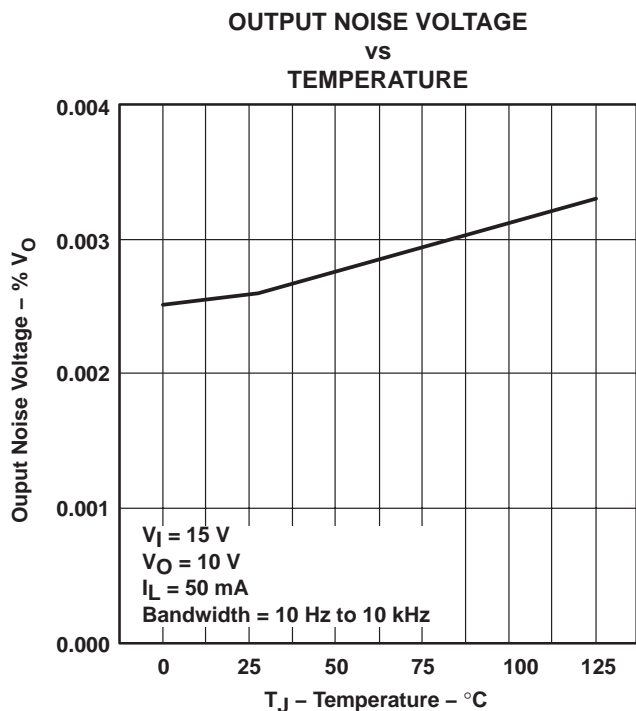

Figure 7

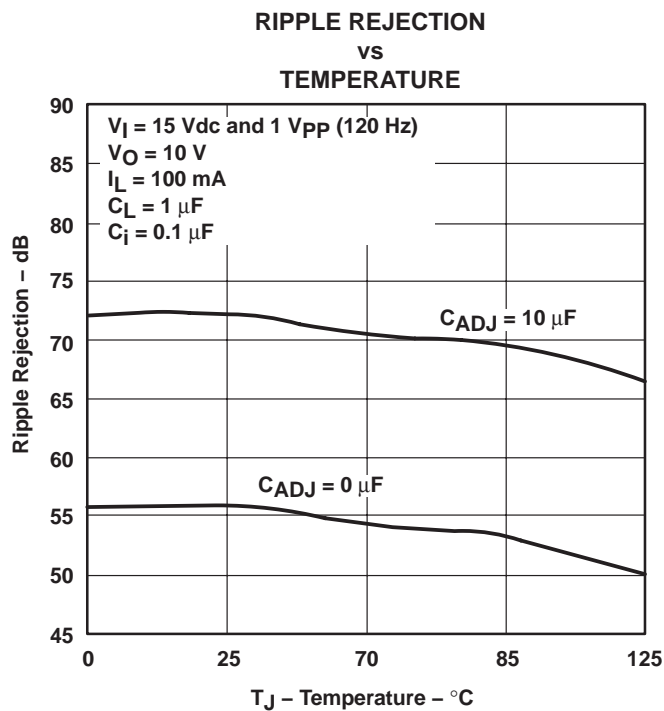
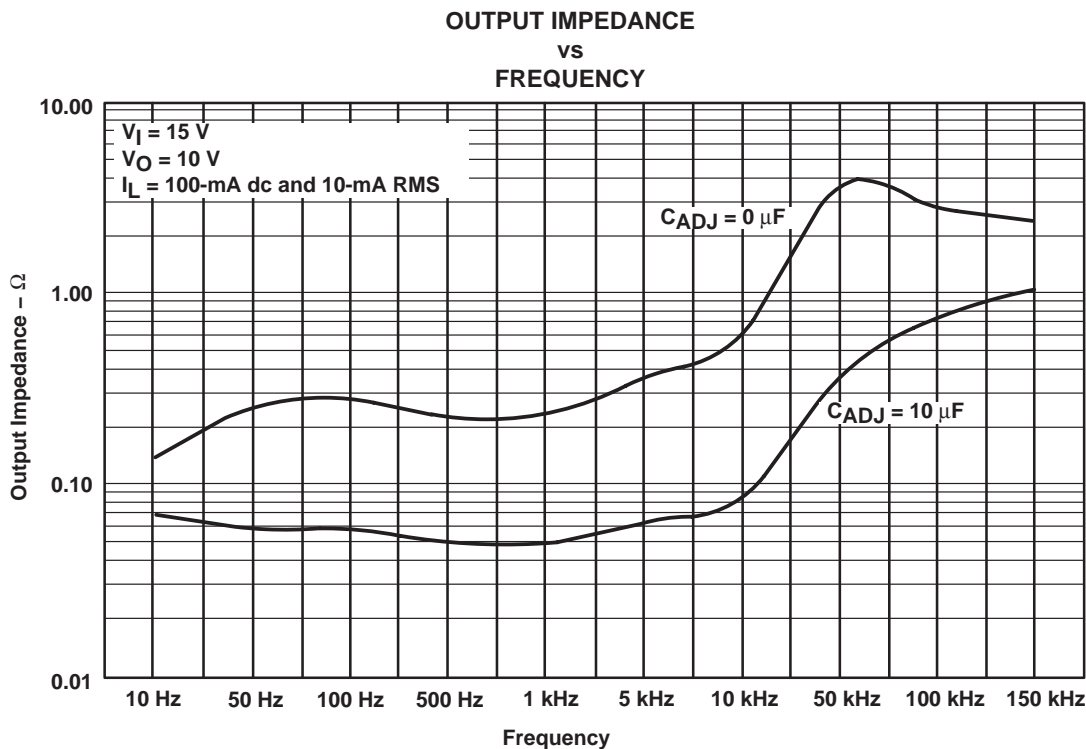
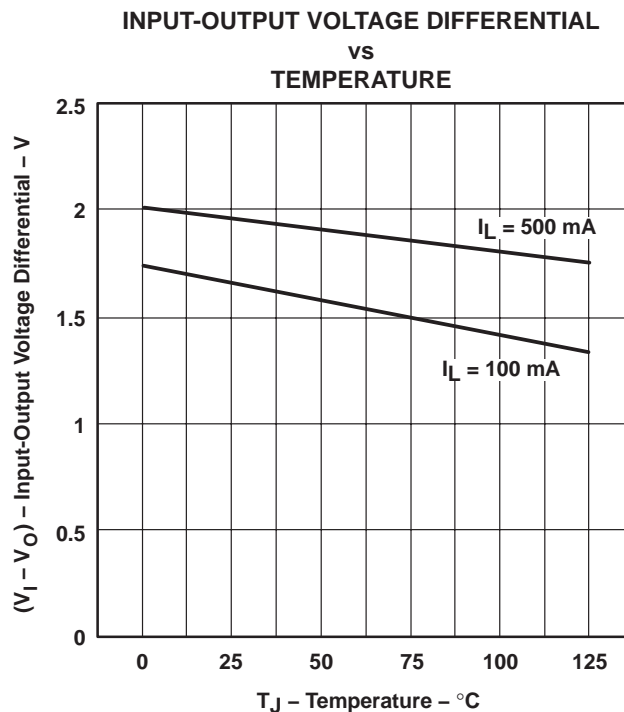
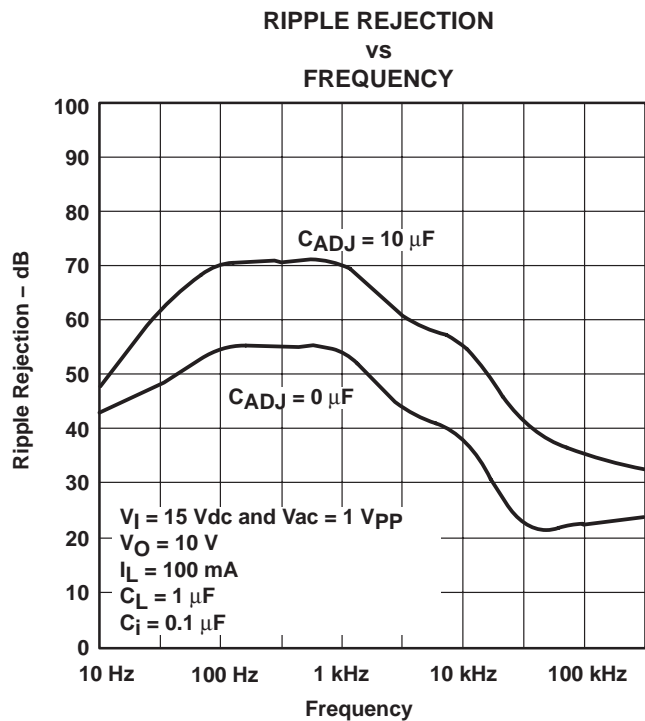

Figure 8



TYPICAL CHARACTERISTICS



LM317M 3-TERMINAL ADJUSTABLE REGULATOR

SLVS297K – APRIL 2000 – REVISED NOVEMBER 2003

TYPICAL CHARACTERISTICS

LINE TRANSIENT RESPONSE vs TIME

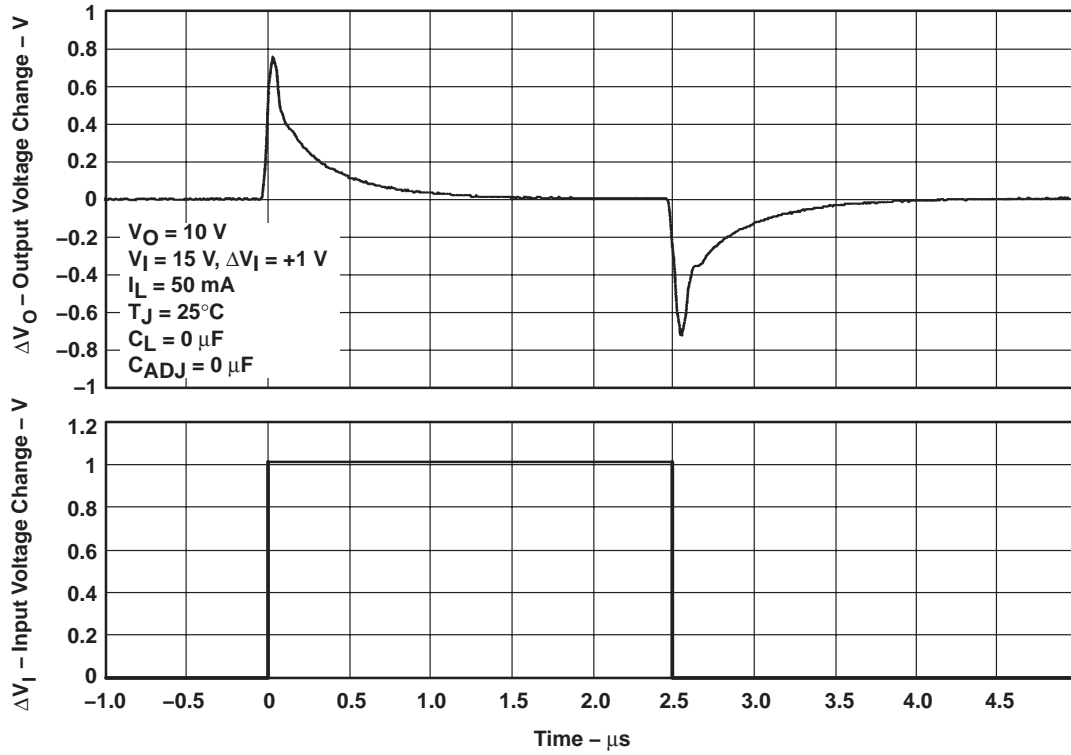

Figure 12

TYPICAL CHARACTERISTICS

LOAD TRANSIENT RESPONSE
vs
TIME

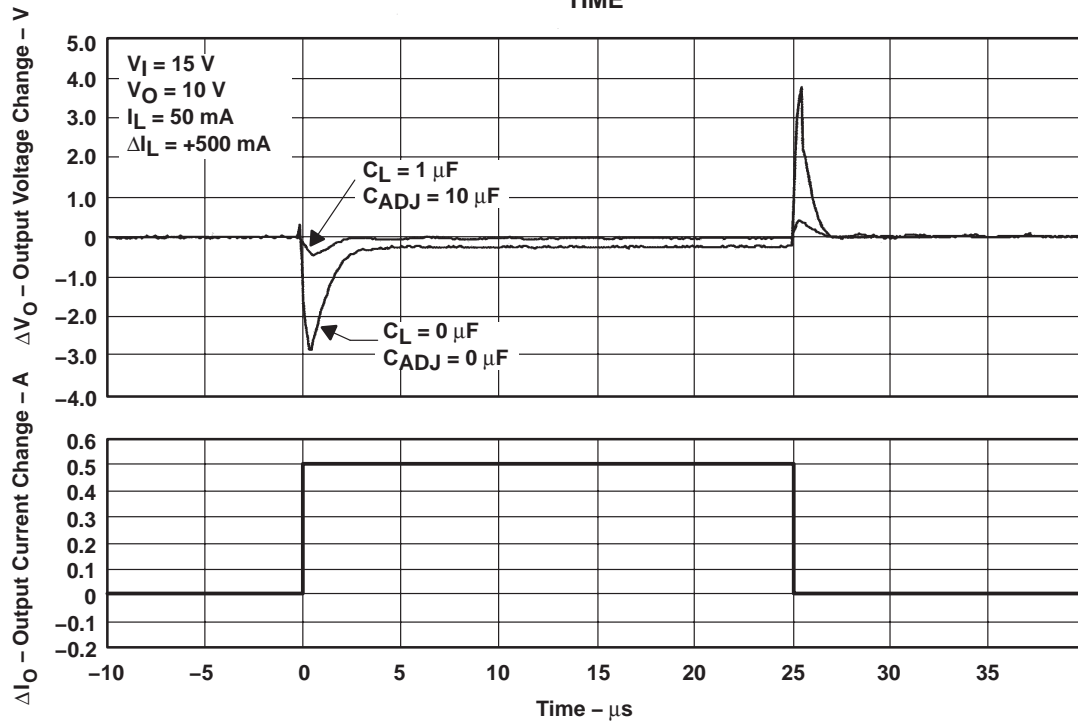

Figure 13

LM317M

3-TERMINAL ADJUSTABLE REGULATOR

SLVS297K – APRIL 2000 – REVISED NOVEMBER 2003

APPLICATION INFORMATION

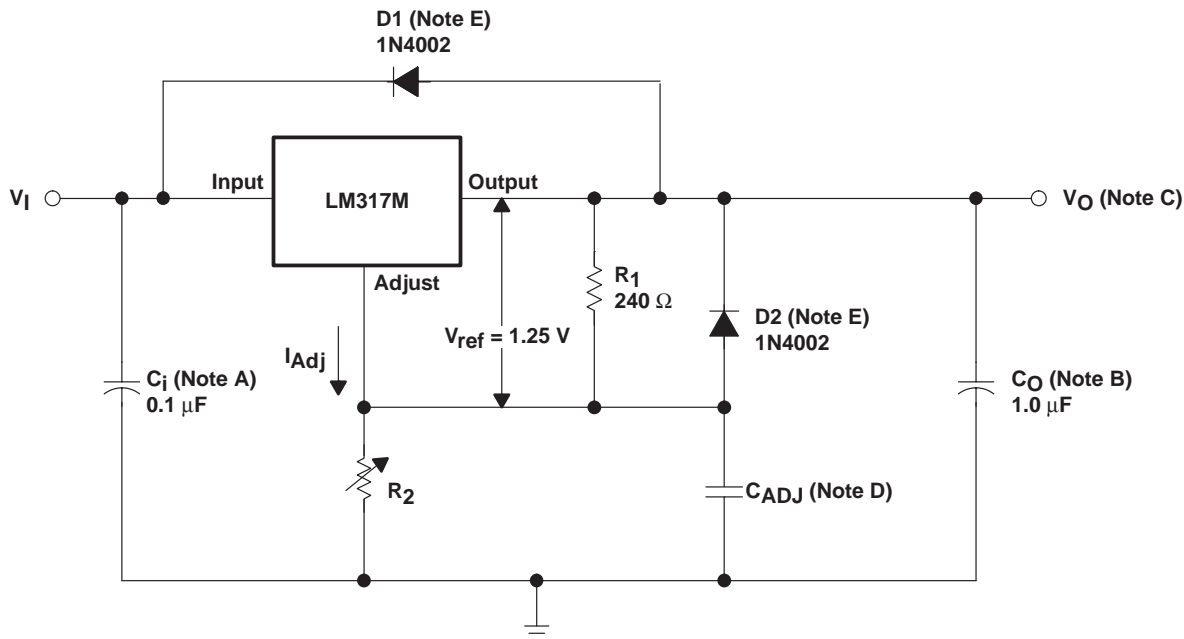

NOTES: A. C_i is not required, but is recommended, particularly if the regulator is not in close proximity to the power-supply filter capacitors. A 0.1- μF disc or 1- μF tantalum provides sufficient bypassing for most applications, especially when adjustment and output capacitors are used.

B. C_O improves transient response, but is not needed for stability.

C. V_O is calculated as shown:

$$V_O = V_{\text{ref}} \left(1 + \frac{R_2}{R_1} \right) + (I_{\text{Adj}} \times R_2)$$

Because I_{Adj} typically is 50 μA , it is negligible in most applications.

D. C_{ADJ} is used to improve ripple rejection; it prevents amplification of the ripple as the output voltage is adjusted higher. If C_{ADJ} is used, it is best to include protection diodes.

E. If the input is shorted to ground during a fault condition, protection diodes provide measures to prevent the possibility of external capacitors discharging through low-impedance paths in the IC. By providing low-impedance discharge paths for C_O and C_{ADJ} , respectively, D1 and D2 prevent the capacitors from discharging into the output of the regulator.

Figure 14. Adjustable Voltage Regulator

DCY (R-PDSO-G4)

PLASTIC SMALL-OUTLINE

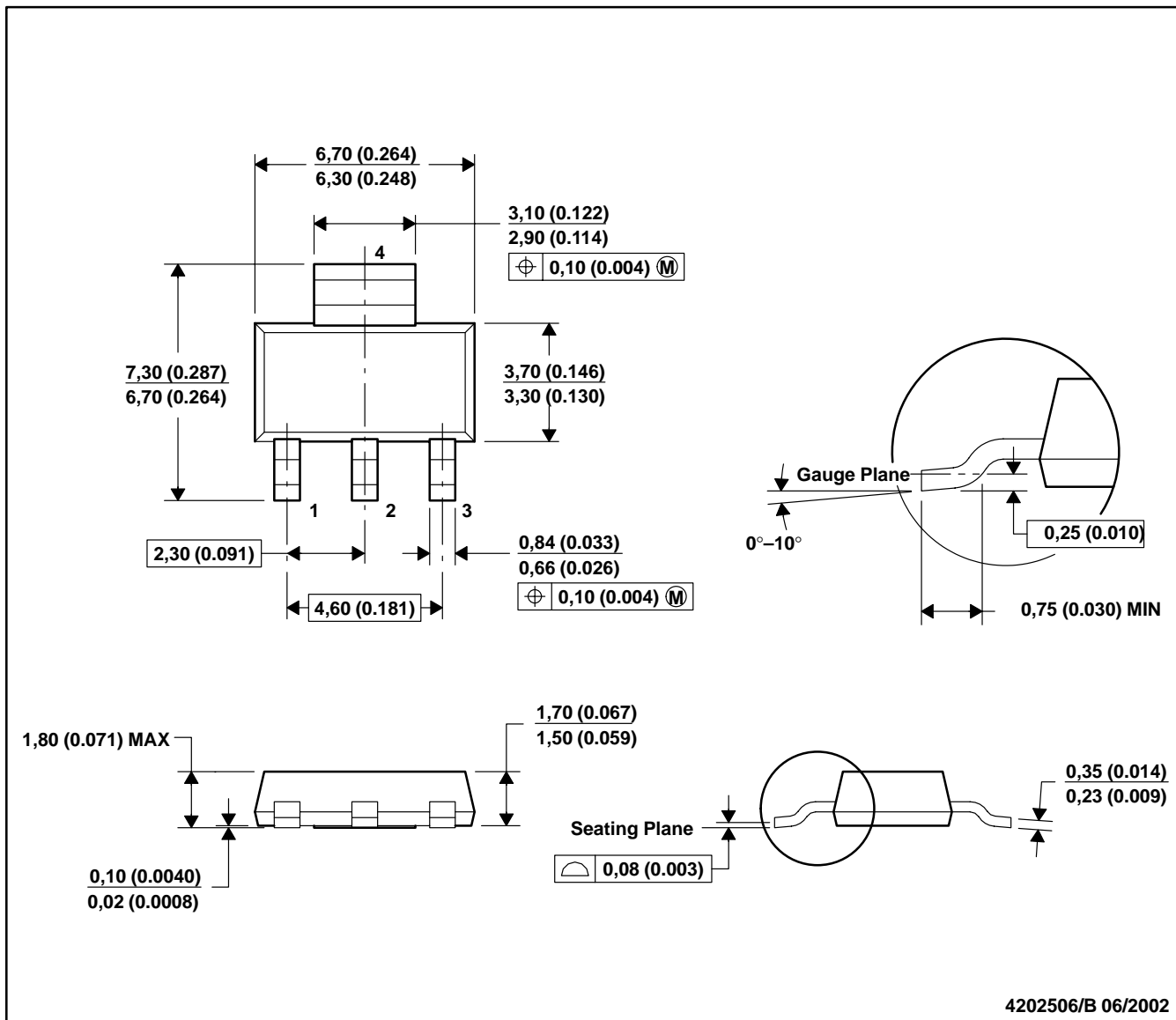

- NOTES: A. All linear dimensions are in millimeters (inches).
 B. This drawing is subject to change without notice.
 C. Body dimensions do not include mold flash or protrusion.
 D. Falls within JEDEC TO-261 Variation AA.

KTP (R-PSFM-G2)

PowerFLEX™ PLASTIC FLANGE-MOUNT PACKAGE

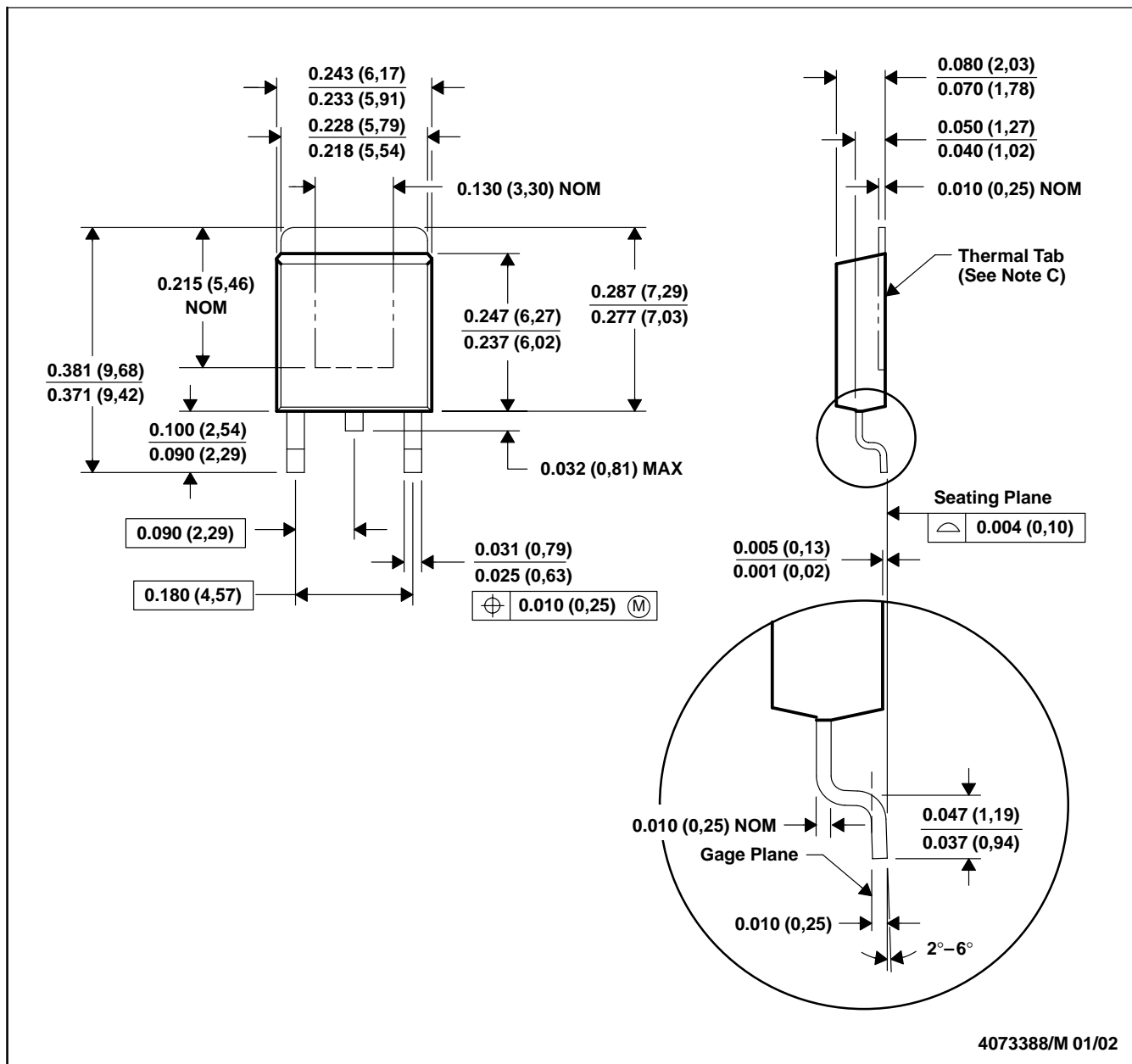

- NOTES: A. All linear dimensions are in inches (millimeters).
 B. This drawing is subject to change without notice.
 C. The center lead is in electrical contact with the thermal tab.
 D. Dimensions do not include mold protrusions, not to exceed 0.006 (0,15).
 E. Falls within JEDEC TO-252 variation AC.

PowerFLEX is a trademark of Texas Instruments.



IMPORTANT NOTICE

Texas Instruments Incorporated and its subsidiaries (TI) reserve the right to make corrections, modifications, enhancements, improvements, and other changes to its products and services at any time and to discontinue any product or service without notice. Customers should obtain the latest relevant information before placing orders and should verify that such information is current and complete. All products are sold subject to TI's terms and conditions of sale supplied at the time of order acknowledgment.

TI warrants performance of its hardware products to the specifications applicable at the time of sale in accordance with TI's standard warranty. Testing and other quality control techniques are used to the extent TI deems necessary to support this warranty. Except where mandated by government requirements, testing of all parameters of each product is not necessarily performed.

TI assumes no liability for applications assistance or customer product design. Customers are responsible for their products and applications using TI components. To minimize the risks associated with customer products and applications, customers should provide adequate design and operating safeguards.

TI does not warrant or represent that any license, either express or implied, is granted under any TI patent right, copyright, mask work right, or other TI intellectual property right relating to any combination, machine, or process in which TI products or services are used. Information published by TI regarding third-party products or services does not constitute a license from TI to use such products or services or a warranty or endorsement thereof. Use of such information may require a license from a third party under the patents or other intellectual property of the third party, or a license from TI under the patents or other intellectual property of TI.

Reproduction of information in TI data books or data sheets is permissible only if reproduction is without alteration and is accompanied by all associated warranties, conditions, limitations, and notices. Reproduction of this information with alteration is an unfair and deceptive business practice. TI is not responsible or liable for such altered documentation.

Resale of TI products or services with statements different from or beyond the parameters stated by TI for that product or service voids all express and any implied warranties for the associated TI product or service and is an unfair and deceptive business practice. TI is not responsible or liable for any such statements.

Following are URLs where you can obtain information on other Texas Instruments products and application solutions:

Products		Applications	
Amplifiers	amplifier.ti.com	Audio	www.ti.com/audio
Data Converters	dataconverter.ti.com	Automotive	www.ti.com/automotive
DSP	dsp.ti.com	Broadband	www.ti.com/broadband
Interface	interface.ti.com	Digital Control	www.ti.com/digitalcontrol
Logic	logic.ti.com	Military	www.ti.com/military
Power Mgmt	power.ti.com	Optical Networking	www.ti.com/opticalnetwork
Microcontrollers	microcontroller.ti.com	Security	www.ti.com/security
		Telephony	www.ti.com/telephony
		Video & Imaging	www.ti.com/video
		Wireless	www.ti.com/wireless

Mailing Address: Texas Instruments
Post Office Box 655303 Dallas, Texas 75265

Copyright © 2003, Texas Instruments Incorporated