

FEATURES

- Output Voltage Range Adjustable From 1.25 V to 37 V
- Output Current Greater Than 500 mA
- Internal Short-Circuit Current Limiting
- Thermal-Overload Protection
- Output Safe-Area Compensation
- Q Devices Meet Automotive Performance Requirements
- Customer-Specific Configuration Control Can Be Supported for Q Devices Along With Major-Change Approval

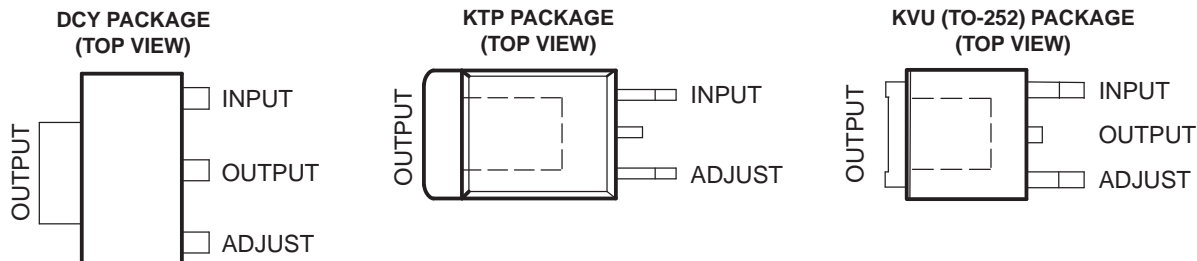

DESCRIPTION/ORDERING INFORMATION

The LM317M is an adjustable 3-terminal positive-voltage regulator capable of supplying more than 500 mA over an output-voltage range of 1.25 V to 37 V. The LM317M is exceptionally easy to use and requires only two external resistors to set the output voltage. Furthermore, both line and load regulation are better than standard fixed regulators.

In addition to having higher performance than fixed regulators, the device includes on-chip current limiting, thermal-overload protection, and safe-operating-area protection. All overload protection remains fully functional if the ADJUST terminal is disconnected.

Normally, no capacitors are needed unless the device is more than six inches from the input filter capacitors, in which case an input bypass capacitor is needed. An optional output capacitor can be added to improve transient response. The ADJUST terminal can be bypassed to achieve high ripple-rejection ratios, which are difficult to achieve with standard three-terminal regulators.

ORDERING INFORMATION

T _J	PACKAGE (1)		ORDERABLE PART NUMBER	TOP-SIDE MARKING
0°C to 125°C	PowerFLEX™ – KTP	Reel of 2000	LM317MKTPR	LM317M
	SOT – DCY	Tube of 80	LM317MDCY	L4
		Reel of 2500	LM317MDCYR	
	TO-252 – KVU	Reel of 2500	LM317MKVURG3	LM317M
–40°C to 125°C	PowerFLEX – KTP	Reel of 2000	LM317MQKTPR	317MQ
	SOT – DCY	Reel of 2500	LM317MQDCYR	L5
			LM317MQDCYRG3	L8

(1) Package drawings, standard packing quantities, thermal data, symbolization, and PCB design guidelines are available at www.ti.com/sc/package.



Please be aware that an important notice concerning availability, standard warranty, and use in critical applications of Texas Instruments semiconductor products and disclaimers thereto appears at the end of this data sheet.

PowerFLEX is a trademark of Texas Instruments.

LM317M

3-TERMINAL ADJUSTABLE REGULATOR

SLVS2970–APRIL 2000–REVISED JULY 2006

Absolute Maximum Ratings⁽¹⁾

over operating temperature range (unless otherwise noted)

		MIN	MAX	UNIT
$V_I - V_O$	Input-to-output differential voltage		40	V
T_J	Operating virtual junction temperature		150	°C
	Lead temperature (within 5 mils of the plastic body for 10 s)		260	°C
		KTP, DCY packages		
T_{stg}	Storage temperature range	–65	150	°C

(1) Stresses beyond those listed under "absolute maximum ratings" may cause permanent damage to the device. These are stress ratings only, and functional operation of the device at these or any other conditions beyond those indicated under "recommended operating conditions" is not implied. Exposure to absolute-maximum-rated conditions for extended periods may affect device reliability.

Package Thermal Data⁽¹⁾

PACKAGE	BOARD	θ_{JC}	θ_{JCB}	θ_{JA}
PowerFLEX (KTP)	High K, JESD 51-5		3°C/W	28°C/W
SOT-223 (DCY)	High K, JESD 51-7	30.6°C/W		53°C/W
TO-252 (KVU)	High K, JESD 51-5			30.3°C/W

(1) Maximum power dissipation is a function of $T_J(\max)$, θ_{JA} , and T_A . The maximum allowable power dissipation at any allowable ambient temperature is $P_D = (T_J(\max) - T_A)/\theta_{JA}$. Operating at the absolute maximum T_J of 150°C can affect reliability.

Recommended Operating Conditions

		MIN	MAX	UNIT
$V_I - V_O$	Input-to-output voltage differential		37	V
I_O	Output current		0.5	A
T_J	Operating virtual junction temperature	No suffix	0	125
		Q suffix	–40	125

Electrical Characteristics

over recommended operating virtual-junction temperature range, $V_I - V_O = 5\text{ V}$, $I_O = 0.1\text{ A}$ (unless otherwise noted)

PARAMETER	TEST CONDITIONS ⁽¹⁾		MIN	TYP	MAX	UNIT
Line regulation ⁽²⁾	$V_I - V_O = 3\text{ V to }40\text{ V}$	$T_J = 25^\circ\text{C}$		0.01	0.04	%V
		Full temperature range		0.02	0.07	
Load regulation	$I_O = 10\text{ mA to }500\text{ mA}$	$T_J = 25^\circ\text{C}$		0.1	0.5	%V _O
		Full temperature range		0.3	1.5	
ADJUST terminal current				50	100	μA
Change in ADJUST terminal current	$V_I - V_O = 3\text{ V to }40\text{ V}$,	$I_O = 10\text{ mA to }500\text{ mA}$		0.2	5	μA
Reference voltage	$V_I - V_O = 3\text{ V to }40\text{ V}$,	$I_O = 10\text{ mA to }500\text{ mA}$	1.2	1.25	1.3	V
Output-voltage temperature stability				0.7		%
Minimum load current to maintain regulation				3.5	10	mA
Maximum output current	$V_I - V_O \leq 15\text{ V}$		500	900		mA
	$V_I - V_O = 40\text{ V}$, $P_D \leq P_{D(\max)}$,	$T_J = 25^\circ\text{C}$	150	250		
RMS output noise voltage (% of V _O)	$f = 10\text{ Hz to }10\text{ kHz}$,	$T_J = 25^\circ\text{C}$		0.003		%V _O
Ripple rejection	$V_O = 10\text{ V}$, $f = 120\text{ Hz}$, $T_J = 25^\circ\text{C}$	$C_{ADJ} = 0^{(3)}$		65		dB
		$C_{ADJ} = 10\text{ }\mu\text{F}^{(3)}$	66	80		
Long-term stability	$T_J = 25^\circ\text{C}$			0.3	1	%/1k hrs

- (1) Pulse-testing techniques are used to maintain the junction temperature as close to the ambient temperature as possible.
 (2) Line voltage regulation is expressed here as the percentage change in output voltage per 1-V change at the input.
 (3) CADJ is connected between the ADJUST terminal and ground.

TYPICAL CHARACTERISTICS

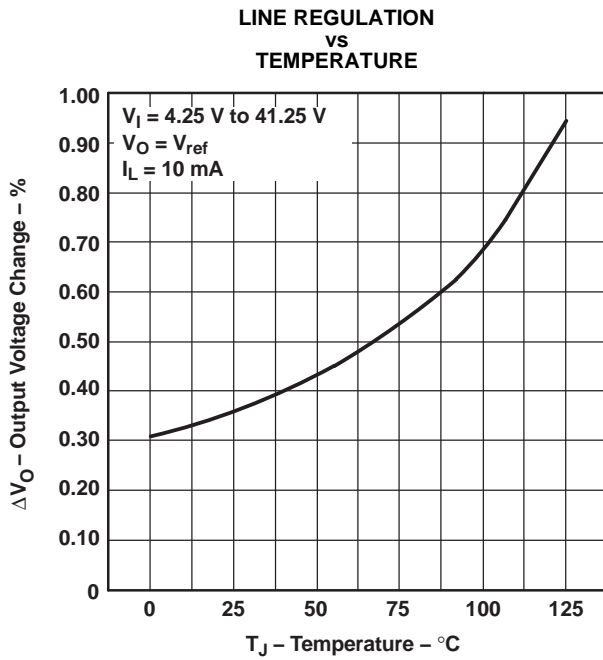

Figure 1.

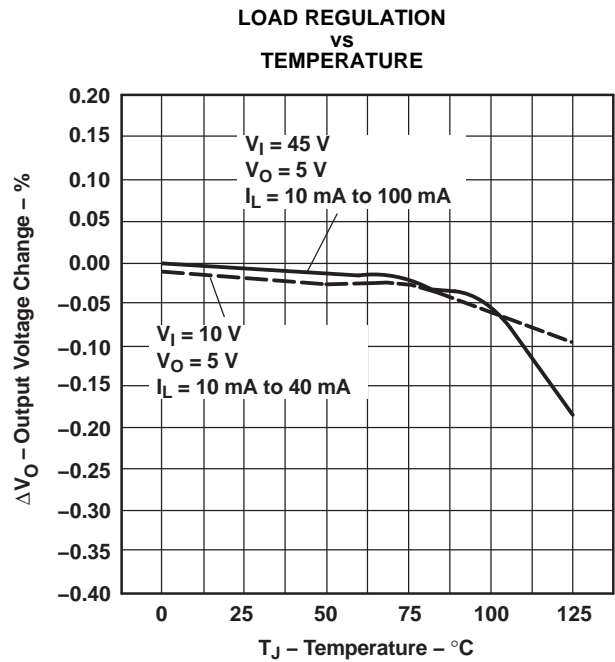

Figure 2.

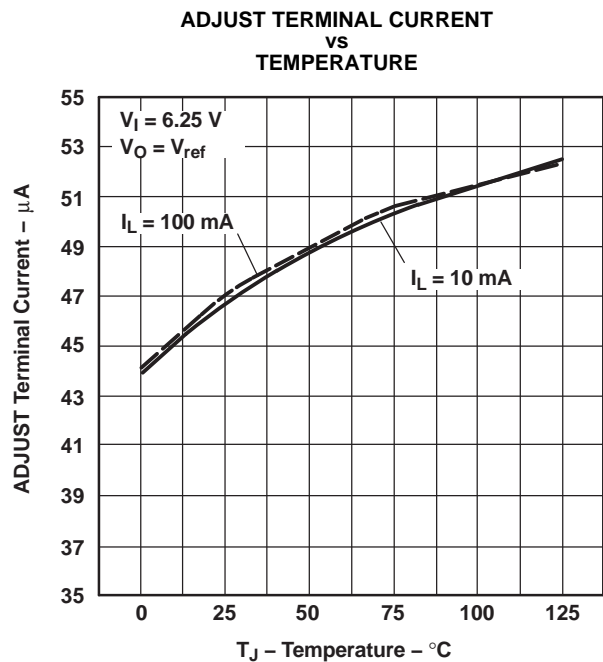

Figure 3.

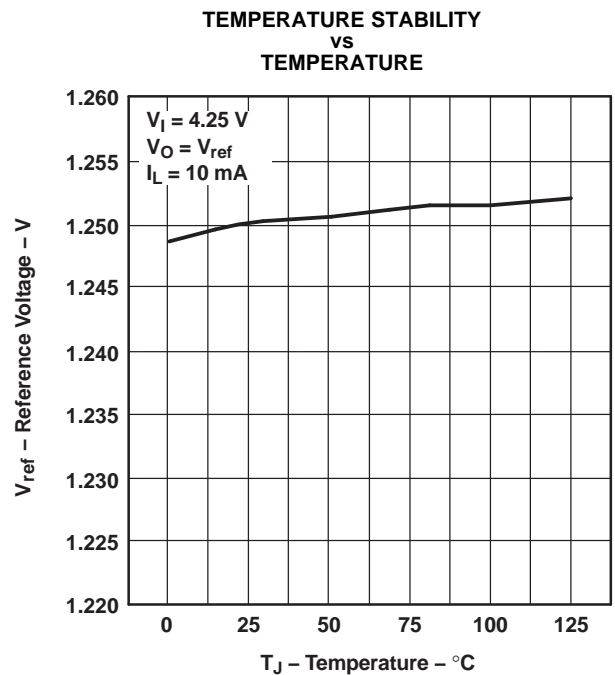

Figure 4.

TYPICAL CHARACTERISTICS (continued)

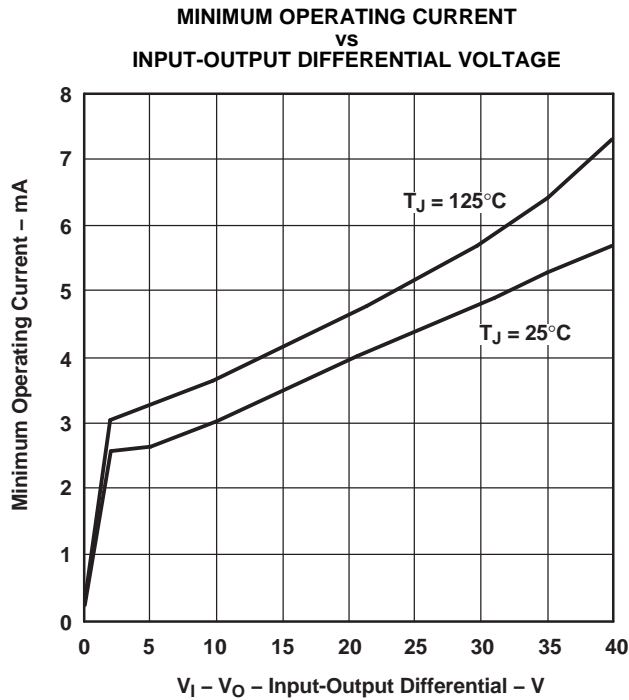

Figure 5.

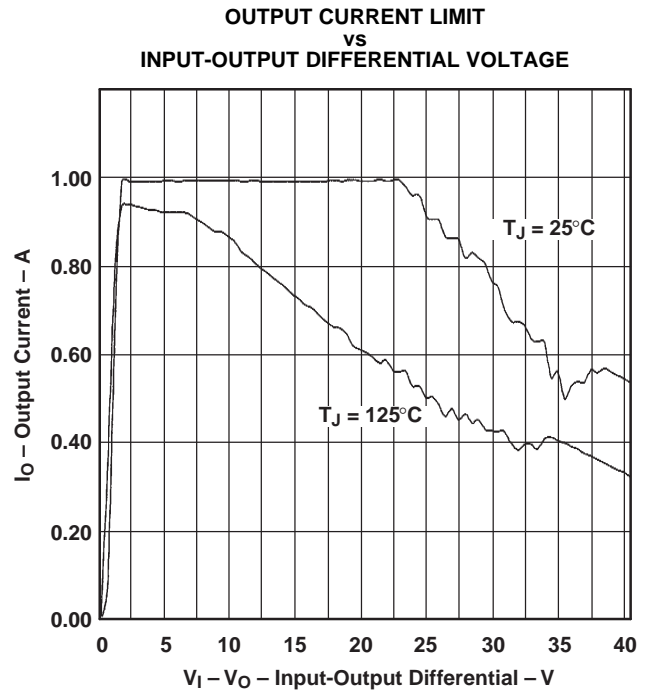

Figure 6.

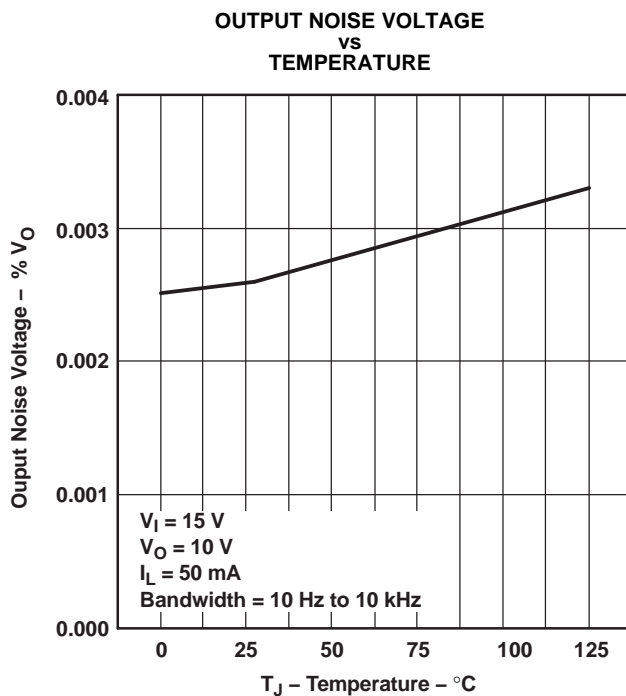

Figure 7.

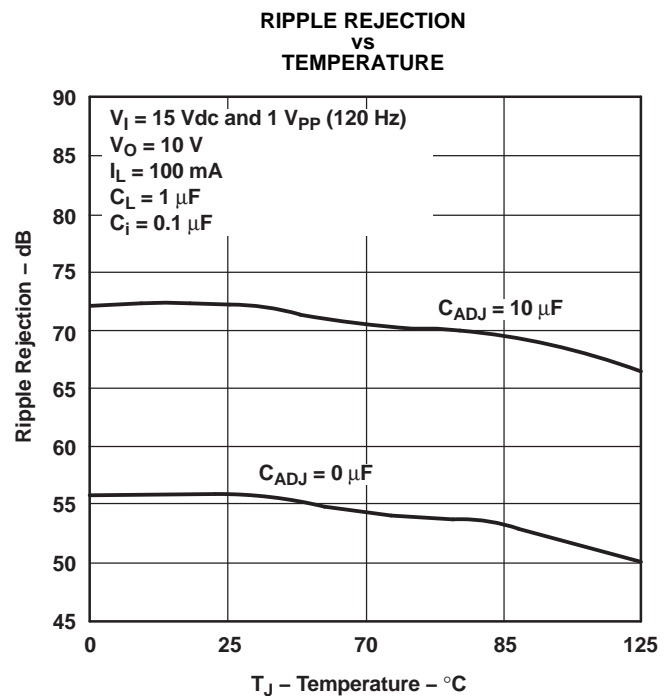

Figure 8.

TYPICAL CHARACTERISTICS (continued)

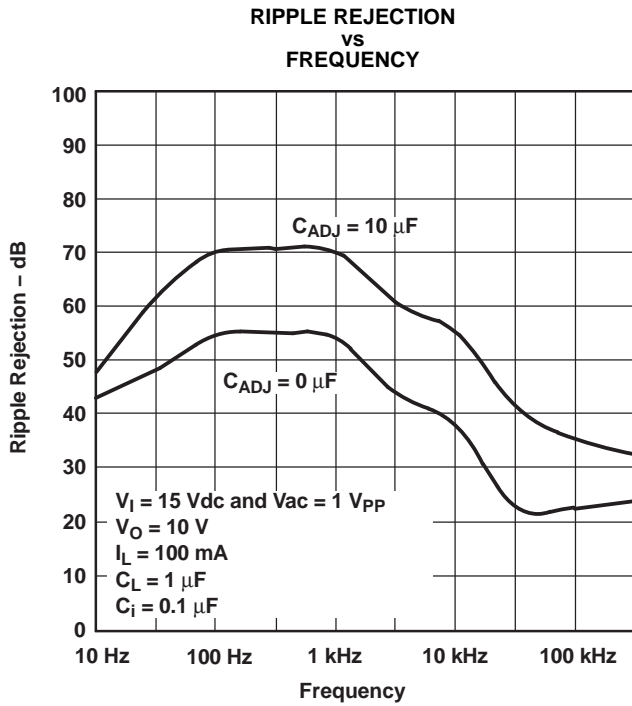

Figure 9.

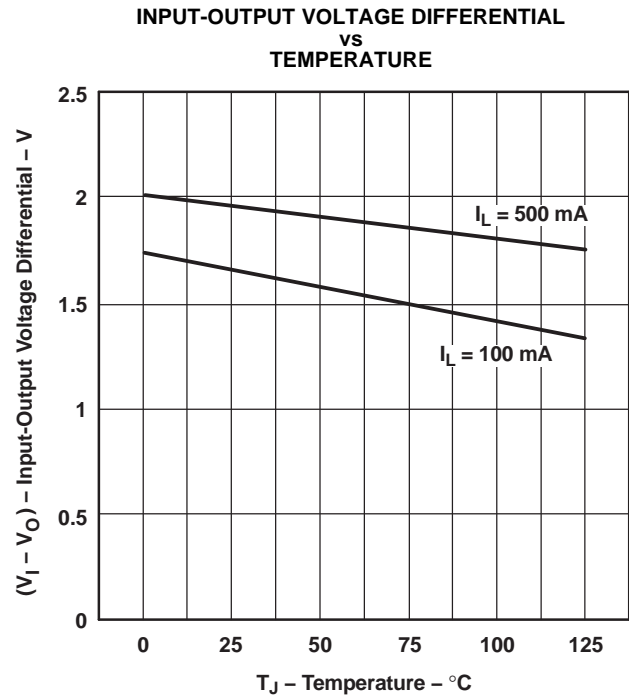

Figure 10.

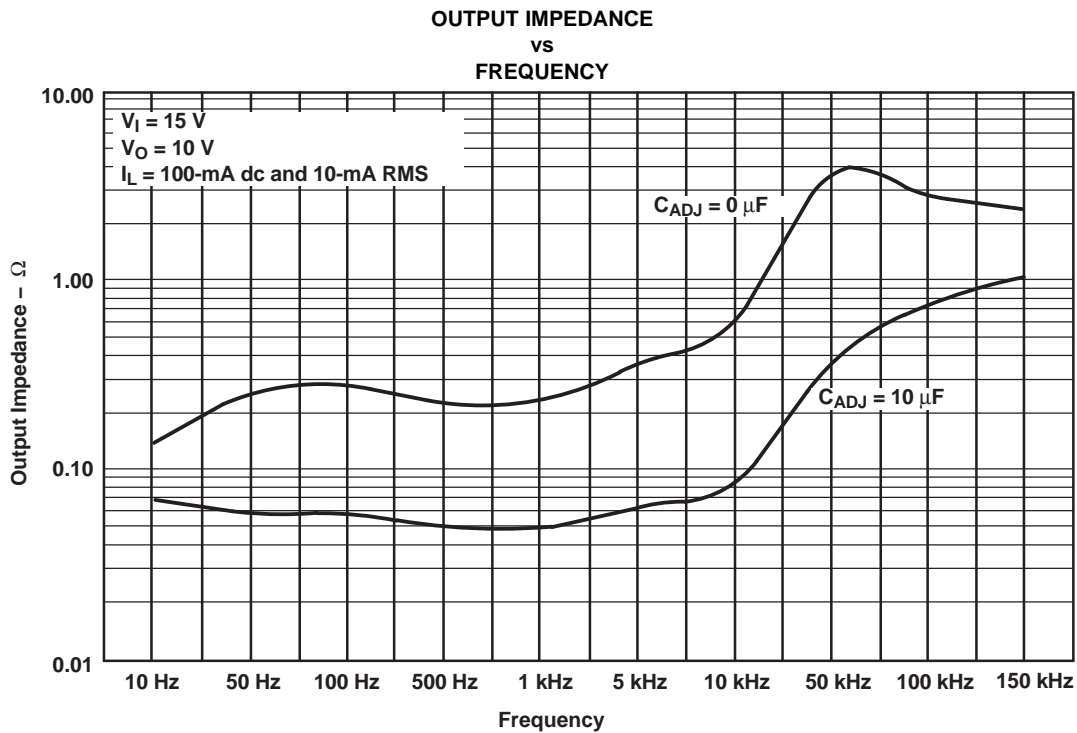

Figure 11.

TYPICAL CHARACTERISTICS (continued)

LINE TRANSIENT RESPONSE
vs
TIME

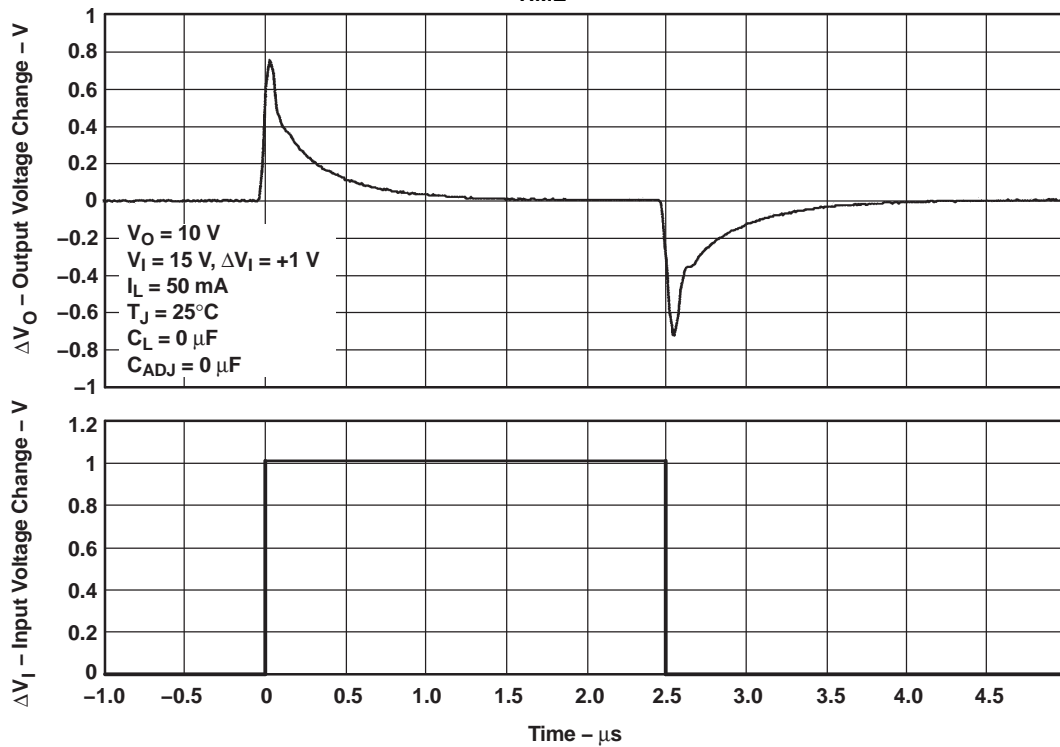

Figure 12.

LOAD TRANSIENT RESPONSE
vs
TIME

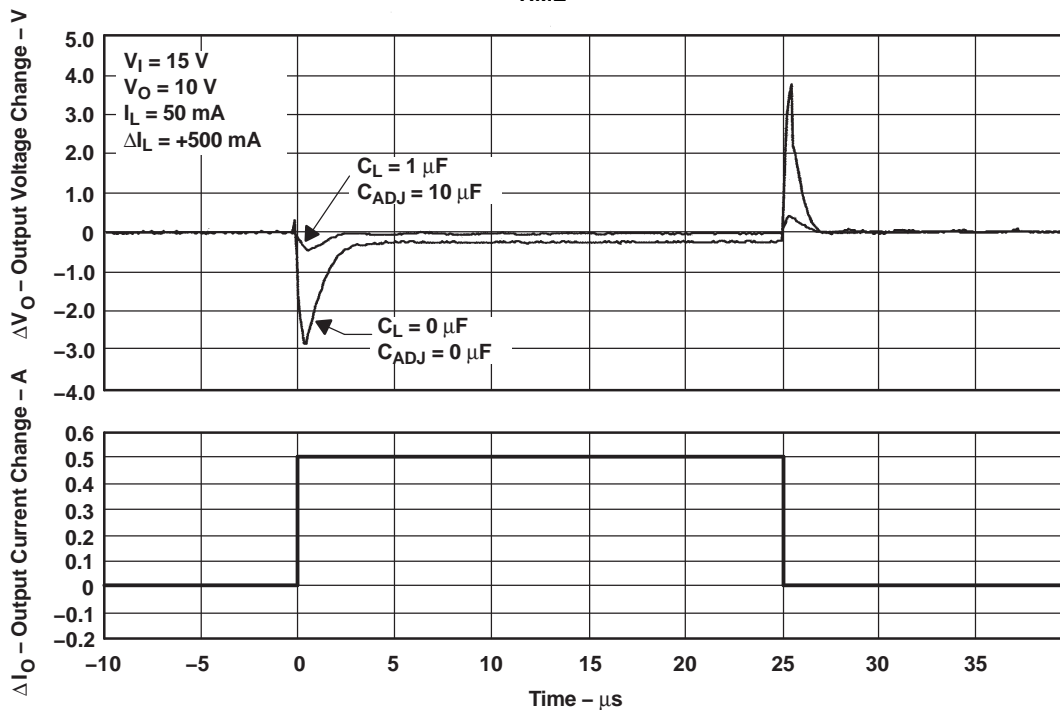
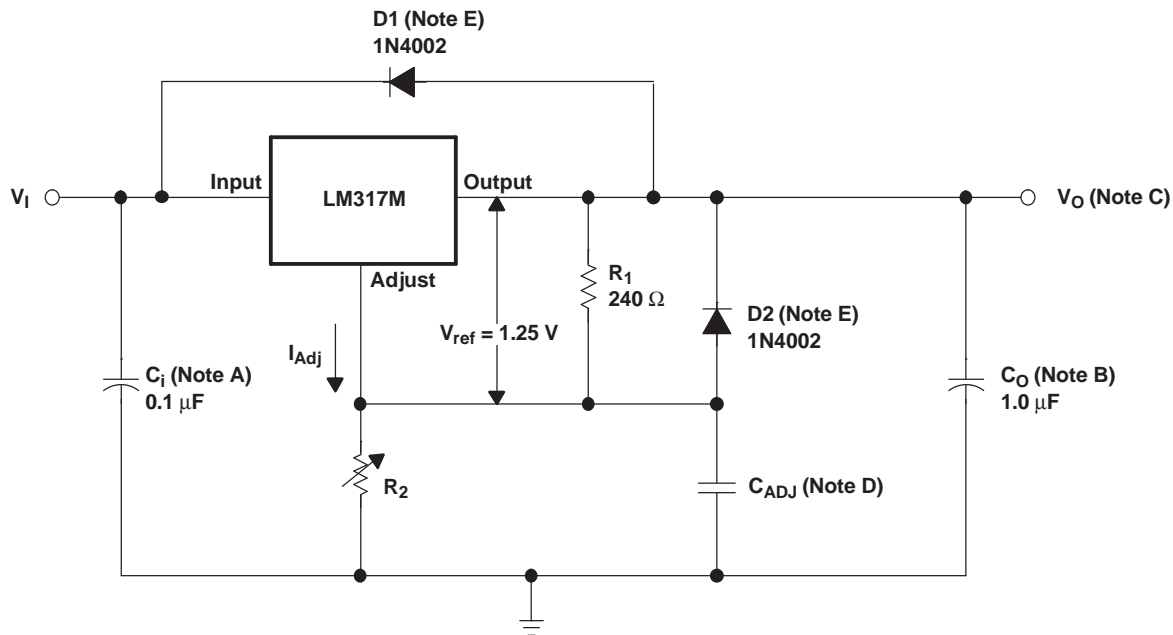

Figure 13.

APPLICATION INFORMATION



- NOTES:
- A. C_i is not required, but is recommended, particularly if the regulator is not in close proximity to the power-supply filter capacitors. A 0.1- μ F disc or 1- μ F tantalum provides sufficient bypassing for most applications, especially when adjustment and output capacitors are used.
 - B. C_o improves transient response, but is not needed for stability.
 - C. V_o is calculated as shown:

$$V_o = V_{ref} \left(1 + \frac{R_2}{R_1} \right) + (I_{Adj} \times R_2)$$

Because I_{Adj} typically is 50 μ A, it is negligible in most applications.

- D. C_{ADJ} is used to improve ripple rejection; it prevents amplification of the ripple as the output voltage is adjusted higher. If C_{ADJ} is used, it is best to include protection diodes.
- E. If the input is shorted to ground during a fault condition, protection diodes provide measures to prevent the possibility of external capacitors discharging through low-impedance paths in the IC. By providing low-impedance discharge paths for C_o and C_{ADJ} , respectively, D1 and D2 prevent the capacitors from discharging into the output of the regulator.

Figure 14. Adjustable Voltage Regulator

PACKAGING INFORMATION

Orderable Device	Status ⁽¹⁾	Package Type	Package Drawing	Pins	Package Qty	Eco Plan ⁽²⁾	Lead/ Ball Finish	MSL Peak Temp ⁽³⁾	Samples (Requires Login)
LM317MDCY	ACTIVE	SOT-223	DCY	4	80	Green (RoHS & no Sb/Br)	CU SN	Level-2-260C-1 YEAR	Contact TI Distributor or Sales Office
LM317MDCYG3	ACTIVE	SOT-223	DCY	4	80	Green (RoHS & no Sb/Br)	CU SN	Level-2-260C-1 YEAR	Contact TI Distributor or Sales Office
LM317MDCYR	ACTIVE	SOT-223	DCY	4	2500	Green (RoHS & no Sb/Br)	CU SN	Level-2-260C-1 YEAR	Contact TI Distributor or Sales Office
LM317MDCYRG3	ACTIVE	SOT-223	DCY	4	2500	Green (RoHS & no Sb/Br)	CU SN	Level-2-260C-1 YEAR	Contact TI Distributor or Sales Office
LM317MKTPR	OBSOLETE	PFM	KTP	2		TBD	Call TI	Call TI	Samples Not Available
LM317MKTPRG3	OBSOLETE	PFM	KTP	2		TBD	Call TI	Call TI	Samples Not Available
LM317MKVURG3	ACTIVE	PFM	KVU	3	2500	Green (RoHS & no Sb/Br)	CU SN	Level-3-260C-168 HR	Request Free Samples
LM317MQDCYR	ACTIVE	SOT-223	DCY	4	2500	Green (RoHS & no Sb/Br)	CU NIPDAU	Level-2-260C-1 YEAR	Purchase Samples
LM317MQDCYRG4	ACTIVE	SOT-223	DCY	4	2500	Green (RoHS & no Sb/Br)	CU NIPDAU	Level-2-260C-1 YEAR	Request Free Samples
LM317MQKTPR	OBSOLETE	PFM	KTP	2		TBD	Call TI	Call TI	Samples Not Available

⁽¹⁾ The marketing status values are defined as follows:

ACTIVE: Product device recommended for new designs.

LIFEBUY: TI has announced that the device will be discontinued, and a lifetime-buy period is in effect.

NRND: Not recommended for new designs. Device is in production to support existing customers, but TI does not recommend using this part in a new design.

PREVIEW: Device has been announced but is not in production. Samples may or may not be available.

OBSOLETE: TI has discontinued the production of the device.

⁽²⁾ Eco Plan - The planned eco-friendly classification: Pb-Free (RoHS), Pb-Free (RoHS Exempt), or Green (RoHS & no Sb/Br) - please check <http://www.ti.com/productcontent> for the latest availability information and additional product content details.

TBD: The Pb-Free/Green conversion plan has not been defined.

Pb-Free (RoHS): TI's terms "Lead-Free" or "Pb-Free" mean semiconductor products that are compatible with the current RoHS requirements for all 6 substances, including the requirement that lead not exceed 0.1% by weight in homogeneous materials. Where designed to be soldered at high temperatures, TI Pb-Free products are suitable for use in specified lead-free processes.

Pb-Free (RoHS Exempt): This component has a RoHS exemption for either 1) lead-based flip-chip solder bumps used between the die and package, or 2) lead-based die adhesive used between the die and leadframe. The component is otherwise considered Pb-Free (RoHS compatible) as defined above.

Green (RoHS & no Sb/Br): TI defines "Green" to mean Pb-Free (RoHS compatible), and free of Bromine (Br) and Antimony (Sb) based flame retardants (Br or Sb do not exceed 0.1% by weight in homogeneous material)

⁽³⁾ MSL, Peak Temp. -- The Moisture Sensitivity Level rating according to the JEDEC industry standard classifications, and peak solder temperature.

Important Information and Disclaimer: The information provided on this page represents TI's knowledge and belief as of the date that it is provided. TI bases its knowledge and belief on information provided by third parties, and makes no representation or warranty as to the accuracy of such information. Efforts are underway to better integrate information from third parties. TI has taken and continues to take reasonable steps to provide representative and accurate information but may not have conducted destructive testing or chemical analysis on incoming materials and chemicals. TI and TI suppliers consider certain information to be proprietary, and thus CAS numbers and other limited information may not be available for release.

In no event shall TI's liability arising out of such information exceed the total purchase price of the TI part(s) at issue in this document sold by TI to Customer on an annual basis.

TAPE AND REEL INFORMATION

REEL DIMENSIONS



TAPE DIMENSIONS



A0	Dimension designed to accommodate the component width
B0	Dimension designed to accommodate the component length
K0	Dimension designed to accommodate the component thickness
W	Overall width of the carrier tape
P1	Pitch between successive cavity centers

TAPE AND REEL INFORMATION

*All dimensions are nominal

Device	Package Type	Package Drawing	Pins	SPQ	Reel Diameter (mm)	Reel Width W1 (mm)	A0 (mm)	B0 (mm)	K0 (mm)	P1 (mm)	W (mm)	Pin1 Quadrant
LM317MDCYR	SOT-223	DCY	4	2500	330.0	12.4	7.05	7.4	1.9	8.0	12.0	Q3
LM317MKVURG3	PFM	KVU	3	2500	330.0	16.4	6.9	10.5	2.7	8.0	16.0	Q2
LM317MQDCYR	SOT-223	DCY	4	2500	330.0	12.4	6.83	7.42	1.88	8.0	12.0	Q3

TAPE AND REEL BOX DIMENSIONS



*All dimensions are nominal

Device	Package Type	Package Drawing	Pins	SPQ	Length (mm)	Width (mm)	Height (mm)
LM317MDCYR	SOT-223	DCY	4	2500	340.0	340.0	38.0
LM317MKVURG3	PFM	KVU	3	2500	340.0	340.0	38.0
LM317MQDCYR	SOT-223	DCY	4	2500	358.0	335.0	35.0

DCY (R-PDSO-G4)

PLASTIC SMALL-OUTLINE

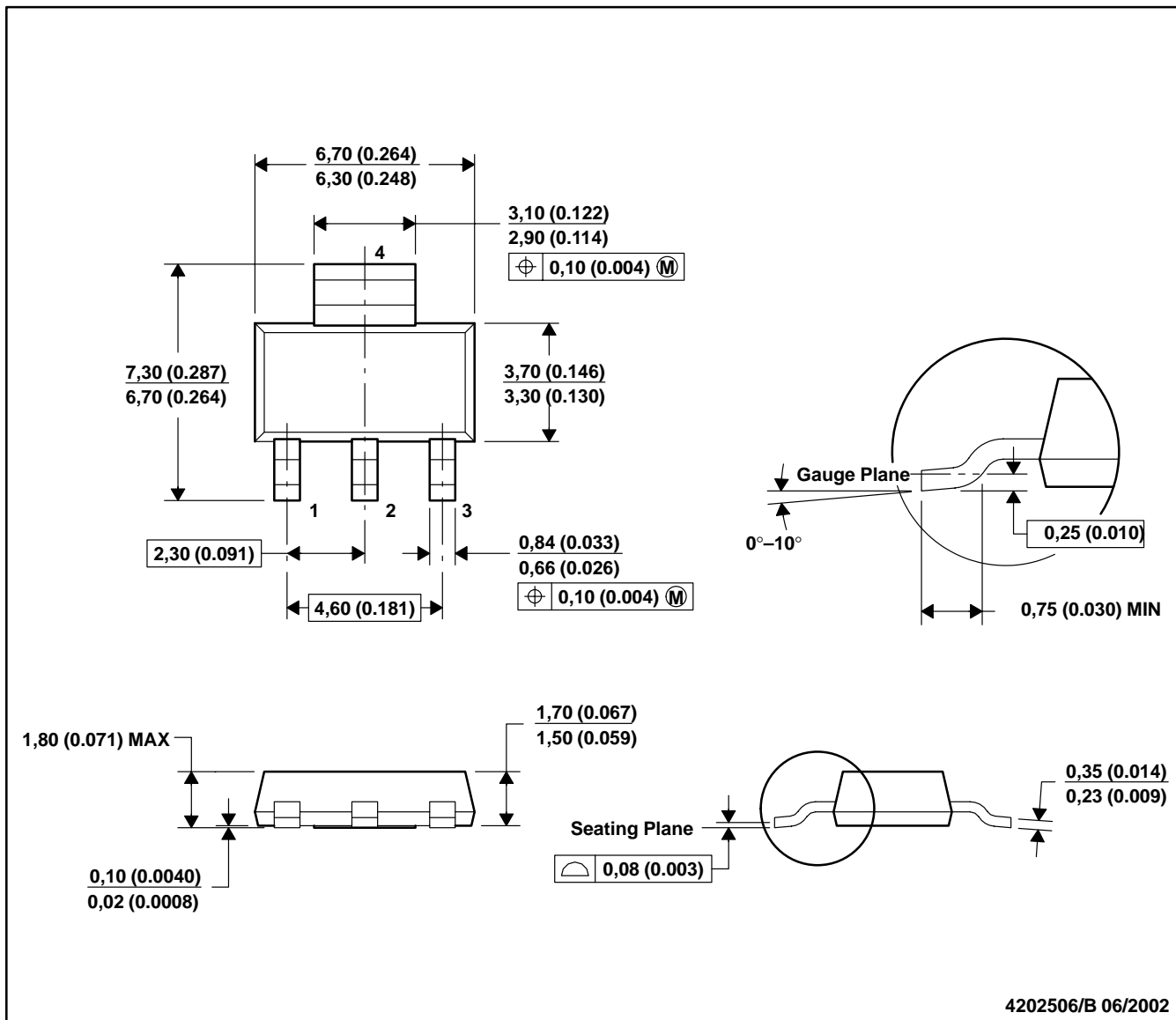

- NOTES: A. All linear dimensions are in millimeters (inches).
 B. This drawing is subject to change without notice.
 C. Body dimensions do not include mold flash or protrusion.
 D. Falls within JEDEC TO-261 Variation AA.

DCY (R-PDSO-G4)

PLASTIC SMALL OUTLINE

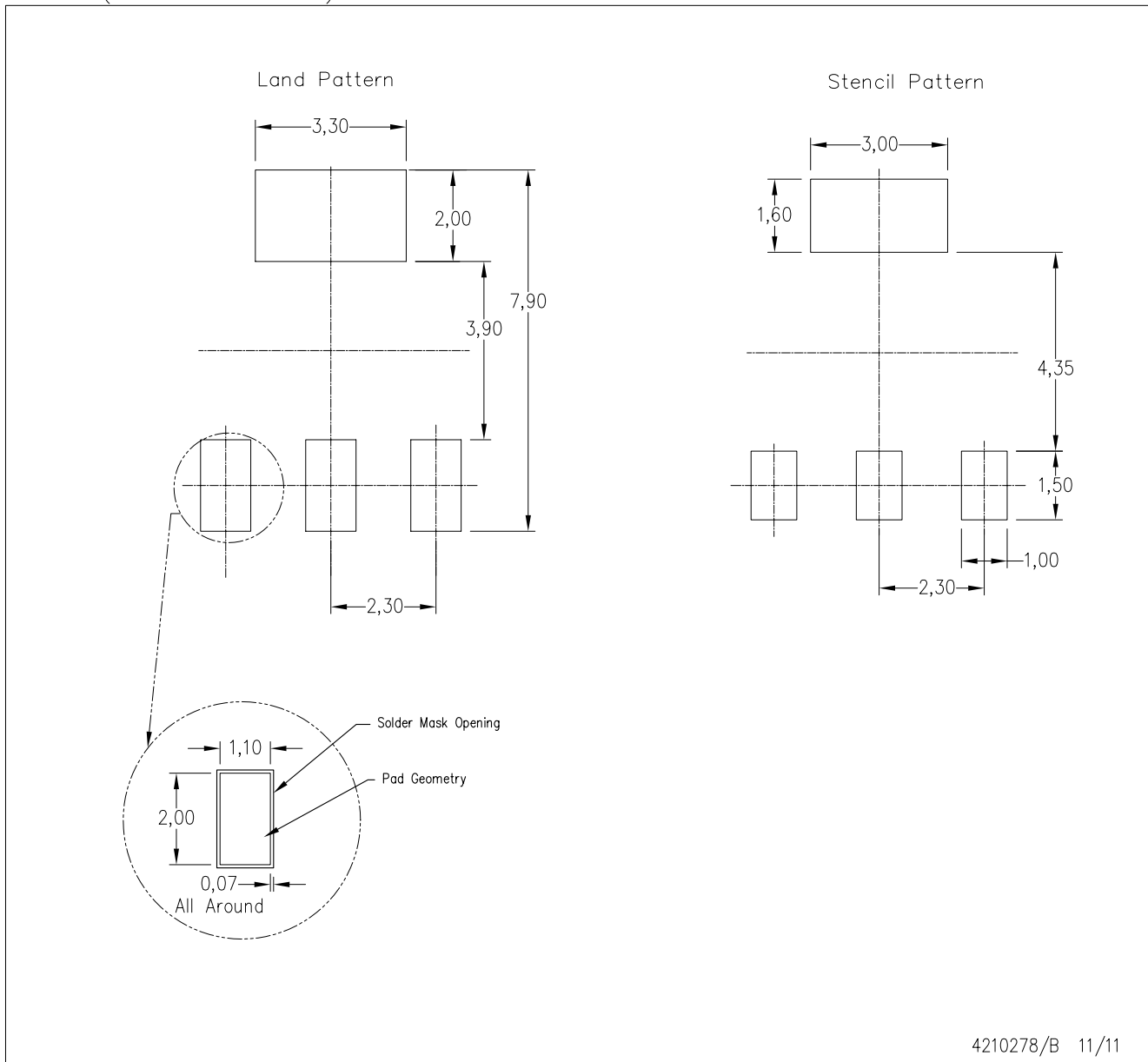

- NOTES:
- A. All linear dimensions are in millimeters.
 - B. This drawing is subject to change without notice.
 - C. Customers should place a note on the circuit board fabrication drawing not to alter the center solder mask defined pad.
 - D. Publication IPC-7351 is recommended for alternate designs.
 - E. Laser cutting apertures with trapezoidal walls and also rounding corners will offer better paste release. Customers should contact their board assembly site for stencil design recommendations.

KTP (R-PSFM-G2)

PowerFLEX™ PLASTIC FLANGE-MOUNT PACKAGE

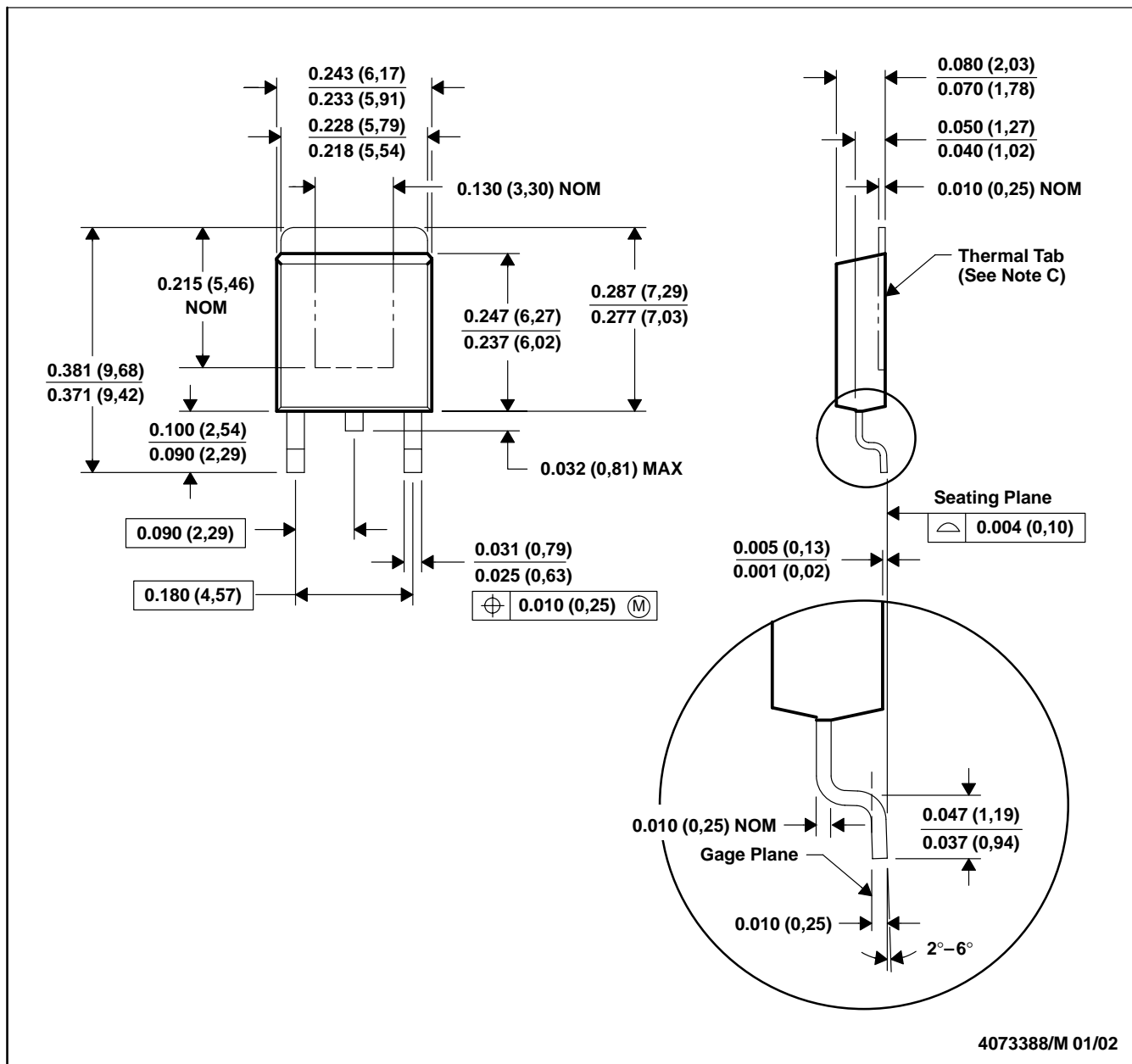

- NOTES: A. All linear dimensions are in inches (millimeters).
 B. This drawing is subject to change without notice.
 C. The center lead is in electrical contact with the thermal tab.
 D. Dimensions do not include mold protrusions, not to exceed 0.006 (0,15).
 E. Falls within JEDEC TO-252 variation AC.

PowerFLEX is a trademark of Texas Instruments.

IMPORTANT NOTICE

Texas Instruments Incorporated and its subsidiaries (TI) reserve the right to make corrections, modifications, enhancements, improvements, and other changes to its products and services at any time and to discontinue any product or service without notice. Customers should obtain the latest relevant information before placing orders and should verify that such information is current and complete. All products are sold subject to TI's terms and conditions of sale supplied at the time of order acknowledgment.

TI warrants performance of its hardware products to the specifications applicable at the time of sale in accordance with TI's standard warranty. Testing and other quality control techniques are used to the extent TI deems necessary to support this warranty. Except where mandated by government requirements, testing of all parameters of each product is not necessarily performed.

TI assumes no liability for applications assistance or customer product design. Customers are responsible for their products and applications using TI components. To minimize the risks associated with customer products and applications, customers should provide adequate design and operating safeguards.

TI does not warrant or represent that any license, either express or implied, is granted under any TI patent right, copyright, mask work right, or other TI intellectual property right relating to any combination, machine, or process in which TI products or services are used. Information published by TI regarding third-party products or services does not constitute a license from TI to use such products or services or a warranty or endorsement thereof. Use of such information may require a license from a third party under the patents or other intellectual property of the third party, or a license from TI under the patents or other intellectual property of TI.

Reproduction of TI information in TI data books or data sheets is permissible only if reproduction is without alteration and is accompanied by all associated warranties, conditions, limitations, and notices. Reproduction of this information with alteration is an unfair and deceptive business practice. TI is not responsible or liable for such altered documentation. Information of third parties may be subject to additional restrictions.

Resale of TI products or services with statements different from or beyond the parameters stated by TI for that product or service voids all express and any implied warranties for the associated TI product or service and is an unfair and deceptive business practice. TI is not responsible or liable for any such statements.

TI products are not authorized for use in safety-critical applications (such as life support) where a failure of the TI product would reasonably be expected to cause severe personal injury or death, unless officers of the parties have executed an agreement specifically governing such use. Buyers represent that they have all necessary expertise in the safety and regulatory ramifications of their applications, and acknowledge and agree that they are solely responsible for all legal, regulatory and safety-related requirements concerning their products and any use of TI products in such safety-critical applications, notwithstanding any applications-related information or support that may be provided by TI. Further, Buyers must fully indemnify TI and its representatives against any damages arising out of the use of TI products in such safety-critical applications.

TI products are neither designed nor intended for use in military/aerospace applications or environments unless the TI products are specifically designated by TI as military-grade or "enhanced plastic." Only products designated by TI as military-grade meet military specifications. Buyers acknowledge and agree that any such use of TI products which TI has not designated as military-grade is solely at the Buyer's risk, and that they are solely responsible for compliance with all legal and regulatory requirements in connection with such use.

TI products are neither designed nor intended for use in automotive applications or environments unless the specific TI products are designated by TI as compliant with ISO/TS 16949 requirements. Buyers acknowledge and agree that, if they use any non-designated products in automotive applications, TI will not be responsible for any failure to meet such requirements.

Following are URLs where you can obtain information on other Texas Instruments products and application solutions:

Products

Audio	www.ti.com/audio
Amplifiers	amplifier.ti.com
Data Converters	dataconverter.ti.com
DLP® Products	www.dlp.com
DSP	dsp.ti.com
Clocks and Timers	www.ti.com/clocks
Interface	interface.ti.com
Logic	logic.ti.com
Power Mgmt	power.ti.com
Microcontrollers	microcontroller.ti.com
RFID	www.ti-rfid.com
OMAP Mobile Processors	www.ti.com/omap
Wireless Connectivity	www.ti.com/wirelessconnectivity

Applications

Automotive and Transportation	www.ti.com/automotive
Communications and Telecom	www.ti.com/communications
Computers and Peripherals	www.ti.com/computers
Consumer Electronics	www.ti.com/consumer-apps
Energy and Lighting	www.ti.com/energy
Industrial	www.ti.com/industrial
Medical	www.ti.com/medical
Security	www.ti.com/security
Space, Avionics and Defense	www.ti.com/space-avionics-defense
Video and Imaging	www.ti.com/video

TI E2E Community Home Page

e2e.ti.com

Mailing Address: Texas Instruments, Post Office Box 655303, Dallas, Texas 75265
Copyright © 2012, Texas Instruments Incorporated