



## 高共模电压差动放大器

### 特性

- 共模电压范围: **±275 V**
- 最小 **CMRR**: **-40°C** 至 **125°C** 时为 **90 dB**
- **DC** 规范
  - 最大偏移电压: **1100 μV**
  - 最大偏移电压漂移: **15 μV/°C**
  - 最大增益误差: **0.02%**
  - 最大增益漂移误差: **10 ppm/°C**
  - 最大增益非线性值: **0.001% FSR**
- **AC** 性能:
  - 带宽: **500 kHz**
  - 典型转换率: **5 V/μs**
- 宽电源电压范围: **±2.0 V** 至 **±18 V**
  - 最大静态电流: **900 μA**
  - **±15-V** 电源的输出摆幅: **±13.5 V**
- 输入保护
  - 共模电压: **±500 V**
  - 差分电压: **±500 V**

### 应用

- 高压电流感应
- 电池电压监视
- 电源电流监视
- 电机控制
- 隔离电路的替代产品

### 说明

INA149 是一款高精度单位增益差动放大器，此放大器具有很高的输入共模电压范围。它是一款包含有高精度运算放大器和集成薄膜电阻器网络的单一单片器件。在共模信号电压高达 **±275 V** 时，INA149 可以准确测量较小的差分电压。INA149 输入受到最高 **500 V** 的瞬时共模电压或者的差分负载的保护。

在很多无需电流隔离的应用中，INA149 可以取代隔离放大器。此功能可以省去昂贵的隔离的输入端电源并去除相关纹波、噪音和静态电流。INA149 出色的 **0.0005%** 非线性和 **500-kHz** 带宽特性使之优于传统隔离放大器。

INA149 与 **INA117**-和 **INA148**-类型高共模电压放大器引脚兼容并且提供优于上述两设备的性能。INA149 采用 **SOIC-8** 封装，额定拓展工业工作温度范围为 **-40°C** 至 **+125°C**。

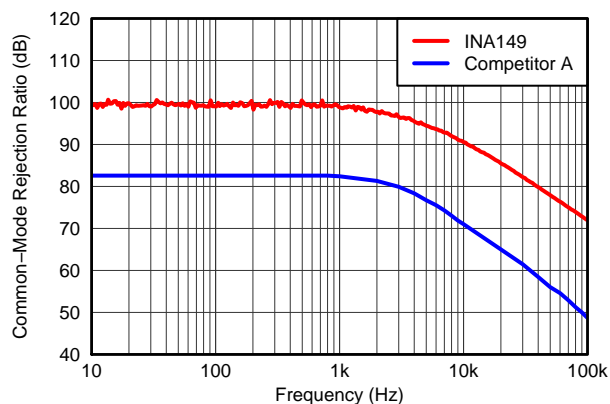

Please be aware that an important notice concerning availability, standard warranty, and use in critical applications of Texas Instruments semiconductor products and disclaimers thereto appears at the end of this data sheet.

All trademarks are the property of their respective owners.



This integrated circuit can be damaged by ESD. Texas Instruments recommends that all integrated circuits be handled with appropriate precautions. Failure to observe proper handling and installation procedures can cause damage.

ESD damage can range from subtle performance degradation to complete device failure. Precision integrated circuits may be more susceptible to damage because very small parametric changes could cause the device not to meet its published specifications.

### PACKAGE/ORDERING INFORMATION<sup>(1)</sup>

| PRODUCT | PACKAGE-LEAD | PACKAGE DESIGNATOR | PACKAGE MARKING |
|---------|--------------|--------------------|-----------------|
| INA149  | SOIC-8       | D                  | INA149A         |

- (1) For the most current package and ordering information, see the Package Option Addendum at the end of this document, or visit the device product folder at [www.ti.com](http://www.ti.com).

### ABSOLUTE MAXIMUM RATINGS<sup>(1)</sup>

Over operating free-air temperature range, unless otherwise noted.

|  |                            | INA149                   | UNIT |
|--|----------------------------|--------------------------|------|
| Supply voltage   | (V+) – (V–)                | 40                       | V    |
| Input voltage range                                      | Continuous                 | 300                      | V    |
| Common-mode and differential, 10 s                       |                            | 500                      | V    |
| Maximum Voltage on REF <sub>A</sub> and REF <sub>B</sub> |                            | (V–) – 0.3 to (V+) + 0.3 | V    |
| Input current on any input pin <sup>(2)</sup>            |                            | 10                       | mA   |
| Output short-circuit current duration                    |                            | Indefinite               |      |
| Operating temperature range                              |                            | –55 to +150              | °C   |
| Storage temperature range                                |                            | –65 to +150              | °C   |
| Junction temperature                                     |                            | +150                     | °C   |
| ESD rating   | Human body model (HBM)     | 1500                     | V    |
|  | Charged device model (CDM) | 1000                     | V    |
|  | Machine model (MM)         | 100                      | V    |

- (1) Stresses above these ratings may cause permanent damage. Exposure to absolute maximum conditions for extended periods may degrade device reliability. These are stress ratings only, and functional operation of the device at these or any other conditions beyond those specified is not implied.
- (2) REF<sub>A</sub> and REF<sub>B</sub> are diode clamped to the power-supply rails. Signals applied to these pins that can swing more than 0.3 V beyond the supply rails should be limited to 10 mA or less.

**ELECTRICAL CHARACTERISTICS:  $V_+ = +15\text{ V}$  and  $V_- = -15\text{ V}$** 

At  $T_A = +25^\circ\text{C}$ ,  $R_L = 2\text{ k}\Omega$  connected to ground, and  $V_{CM} = \text{REF}_A = \text{REF}_B = \text{GND}$ , unless otherwise noted.

| PARAMETER                    | TEST CONDITIONS   | INA149  |              |             | UNIT                         |
|------------------------------|---|---------|--------------|-------------|------------------------------|
|                              |   | MIN     | TYP          | MAX         |                              |
| <b>GAIN</b>                  |   |         |              |             |                              |
| Initial                      | $V_{OUT} = \pm 10.0\text{ V}$   |         | 1            |             | V/V                          |
| Gain error                   | $V_{OUT} = \pm 10.0\text{ V}$   |         | $\pm 0.005$  | $\pm 0.02$  | %FSR                         |
| Gain                         | vs temperature, $T_A = -40^\circ\text{C}$ to $+125^\circ\text{C}$         |         | $\pm 1.5$    | $\pm 10$    | ppm/ $^\circ\text{C}$        |
| Nonlinearity                 |   |         | $\pm 0.0005$ | $\pm 0.001$ | %FSR                         |
| <b>OFFSET VOLTAGE</b>        |   |         |              |             |                              |
| Initial offset               |   |         | 350          | 1100        | $\mu\text{V}$                |
|                              | vs temperature, $T_A = -40^\circ\text{C}$ to $+125^\circ\text{C}$         |         | 3            | 15          | $\mu\text{V}/^\circ\text{C}$ |
|                              | vs supply (PSRR), $V_S = \pm 2\text{ V}$ to $\pm 18\text{ V}$             | 90      | 120          |             | dB                           |
| <b>INPUT</b>                 |   |         |              |             |                              |
| Impedance                    | Differential  |         | 800          |             | k $\Omega$                   |
|                              | Common-mode   |         | 200          |             | k $\Omega$                   |
| Voltage range                | Differential  | -13.5   |              | 13.5        | V                            |
|                              | Common-mode   | -275    |              | 275         | V                            |
| Common-mode rejection (CMRR) | At dc, $V_{CM} = \pm 275\text{ V}$  | 90      | 100          |             | dB                           |
|                              | vs temperature, $T_A = -40^\circ\text{C}$ to $+125^\circ\text{C}$ , at dc | 90      |              |             | dB                           |
|                              | At ac, 500 Hz, $V_{CM} = 500\text{ V}_{PP}$                               | 90      |              |             | dB                           |
|                              | At ac, 1 kHz, $V_{CM} = 500\text{ V}_{PP}$                                |         | 90           |             | dB                           |
| <b>OUTPUT</b>                |   |         |              |             |                              |
| Voltage range                |   | -13.5   |              | 13.5        | V                            |
| Short-circuit current        |   |         | $\pm 25$     |             | mA                           |
| Capacitive load drive        | No sustained oscillations   |         | 10           |             | nF                           |
| <b>OUTPUT NOISE VOLTAGE</b>  |   |         |              |             |                              |
| 0.01 Hz to 10 Hz             |   |         | 20           |             | $\mu\text{V}_{PP}$           |
| 10 kHz                       |   |         | 550          |             | $\text{nV}/\sqrt{\text{Hz}}$ |
| <b>DYNAMIC RESPONSE</b>      |   |         |              |             |                              |
| Small-signal bandwidth       |   |         | 500          |             | kHz                          |
| Slew rate                    | $V_{OUT} = \pm 10\text{-V}$ step  | 1.7     | 5            |             | V/ $\mu\text{s}$             |
| Full-power bandwidth         | $V_{OUT} = 20\text{ V}_{PP}$  |         | 32           |             | kHz                          |
| Settling time                | 0.01%, $V_{OUT} = 10\text{-V}$ step                                       |         | 7            |             | $\mu\text{s}$                |
| <b>POWER SUPPLY</b>          |   |         |              |             |                              |
| Voltage range                |   | $\pm 2$ |              | $\pm 18$    | V                            |
| Quiescent current            | $V_S = \pm 18\text{ V}$ , $V_{OUT} = 0\text{ V}$                          |         | 810          | 900         | $\mu\text{A}$                |
|                              | vs temperature, $T_A = -40^\circ\text{C}$ to $+125^\circ\text{C}$         |         |              | 1.1         | mA                           |
| <b>TEMPERATURE RANGE</b>     |   |         |              |             |                              |
| Specified                    |   | -40     |              | +125        | $^\circ\text{C}$             |
| Operating                    |   | -55     |              | +150        | $^\circ\text{C}$             |
| Storage                      |   | -65     |              | +150        | $^\circ\text{C}$             |

**ELECTRICAL CHARACTERISTICS:  $V_+ = 5\text{ V}$  and  $V_- = 0\text{ V}$** 

At  $T_A = +25^\circ\text{C}$ ,  $R_L = 2\text{ k}\Omega$  connected to  $2.5\text{ V}$ , and  $V_{CM} = \text{REF}_A = \text{REF}_B = 2.5\text{ V}$ , unless otherwise noted.

| PARAMETER                   | TEST CONDITIONS   | INA149 |              |     | UNIT                         |
|-----------------------------|---|--------|--------------|-----|------------------------------|
|                             |   | MIN    | TYP          | MAX |                              |
| <b>GAIN</b>                 |   |        |              |     |                              |
| Initial                     | $V_{OUT} = 1.5\text{ V to }3.5\text{ V}$                                |        | 1            |     | V/V                          |
| Gain error                  | $V_{OUT} = 1.5\text{ V to }3.5\text{ V}$                                |        | $\pm 0.005$  |     | %FSR                         |
| Gain                        | vs temperature, $T_A = -40^\circ\text{C to }+125^\circ\text{C}$         |        | $\pm 1.5$    |     | ppm/ $^\circ\text{C}$        |
| Nonlinearity                |   |        | $\pm 0.0005$ |     | %FSR                         |
| <b>OFFSET VOLTAGE</b>       |   |        |              |     |                              |
| Initial offset              |   |        | 350          |     | $\mu\text{V}$                |
|                             | vs temperature, $T_A = -40^\circ\text{C to }+125^\circ\text{C}$         |        | 3            |     | $\mu\text{V}/^\circ\text{C}$ |
|                             | vs supply (PSRR), $V_S = 4\text{ V to }5\text{ V}$                      |        | 120          |     | dB                           |
| <b>INPUT</b>                |   |        |              |     |                              |
| Impedance                   | Differential  |        | 800          |     | k $\Omega$                   |
|                             | Common-mode   |        | 200          |     | k $\Omega$                   |
| Voltage range               | Differential  | 1.5    |              | 3.5 | V                            |
|                             | Common-mode   | -20    |              | 25  | V                            |
| Common-mode rejection       | At dc, $V_{CM} = -20\text{ V to }25\text{ V}$                           |        | 100          |     | dB                           |
|                             | vs temperature, $T_A = -40^\circ\text{C to }+125^\circ\text{C}$ , at dc |        | 100          |     | dB                           |
|                             | At ac, 500 Hz, $V_{CM} = 49\text{ V}_{PP}$                              |        | 100          |     | dB                           |
|                             | At ac, 1 kHz, $V_{CM} = 49\text{ V}_{PP}$                               |        | 90           |     | dB                           |
| <b>OUTPUT</b>               |   |        |              |     |                              |
| Voltage range               |   | 1.5    |              | 3.5 | V                            |
| Short-circuit current       |   |        | $\pm 15$     |     | mA                           |
| Capacitive load drive       | No sustained oscillations   |        | 10           |     | nF                           |
| <b>OUTPUT NOISE VOLTAGE</b> |   |        |              |     |                              |
| 0.01 Hz to 10 Hz            |   |        | 20           |     | $\mu\text{V}_{PP}$           |
| 10 kHz                      |   |        | 550          |     | $\text{nV}/\sqrt{\text{Hz}}$ |
| <b>DYNAMIC RESPONSE</b>     |   |        |              |     |                              |
| Small-signal bandwidth      |   |        | 500          |     | kHz                          |
| Slew rate                   | $V_{OUT} = 2\text{ V}_{PP}$ step  |        | 5            |     | V/ $\mu\text{s}$             |
| Full-power bandwidth        | $V_{OUT} = 2\text{ V}_{PP}$   |        | 32           |     | kHz                          |
| Settling time               | 0.01%, $V_{OUT} = 2\text{ V}_{PP}$ step                                 |        | 7            |     | $\mu\text{s}$                |
| <b>POWER SUPPLY</b>         |   |        |              |     |                              |
| Voltage range               |   |        | 5            |     | V                            |
| Quiescent current           | $V_S = 5\text{ V}$  |        | 810          |     | $\mu\text{A}$                |
|                             | vs temperature, $T_A = -40^\circ\text{C to }+125^\circ\text{C}$         |        | 1            |     | mA                           |

**THERMAL INFORMATION**

| THERMAL METRIC <sup>(1)</sup> |  | INA149   | UNITS |
|-------------------------------|--|----------|-------|
|                               |  | D (SOIC) |       |
|                               |  | 8 PINS   |       |
| $\theta_{JA}$                 | Junction-to-ambient thermal resistance       | 110      | °C/W  |
| $\theta_{JCTop}$              | Junction-to-case (top) thermal resistance    | 57       |       |
| $\theta_{JB}$                 | Junction-to-board thermal resistance         | 54       |       |
| $\psi_{JT}$                   | Junction-to-top characterization parameter   | 11       |       |
| $\psi_{JB}$                   | Junction-to-board characterization parameter | 53       |       |
| $\theta_{JCbott}$             | Junction-to-case (bottom) thermal resistance | N/A      |       |

(1) For more information about traditional and new thermal metrics, see the *IC Package Thermal Metrics* application report, [SPRA953](#).

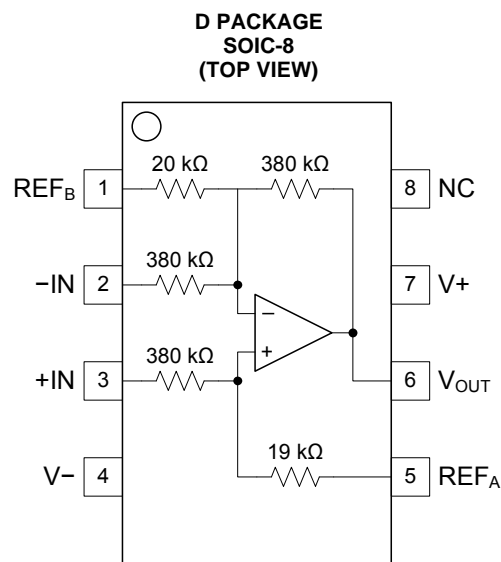
**PIN CONFIGURATION**

**PIN DESCRIPTIONS**

| NAME             | NO. | DESCRIPTION                          |
|------------------|-----|--------------------------------------|
| -IN              | 2   | Inverting input                      |
| +IN              | 3   | Noninverting input                   |
| NC               | 8   | No internal connection               |
| REF <sub>A</sub> | 5   | Reference input                      |
| REF <sub>B</sub> | 1   | Reference input                      |
| V-               | 4   | Negative power supply                |
| V+               | 7   | Positive power supply <sup>(1)</sup> |
| V <sub>OUT</sub> | 6   | Output                               |

(1) In this document, (V+) – (V-) is referred to as  $V_S$ .

### TYPICAL CHARACTERISTICS

At  $T_A = +25^\circ\text{C}$ ,  $R_L = 2\text{ k}\Omega$  connected to ground, and  $V_S = \pm 15\text{ V}$ , unless otherwise noted.

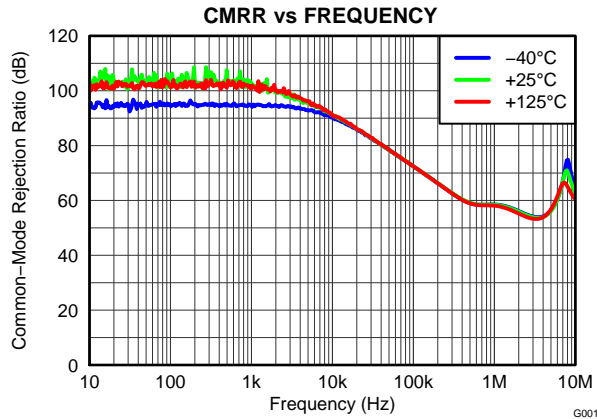

Figure 1.

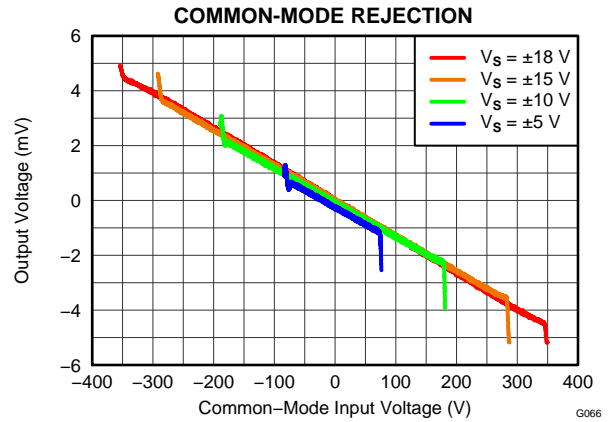

Figure 2.

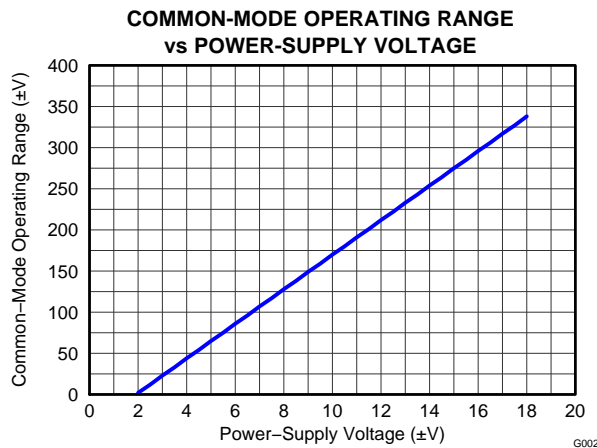

Figure 3.

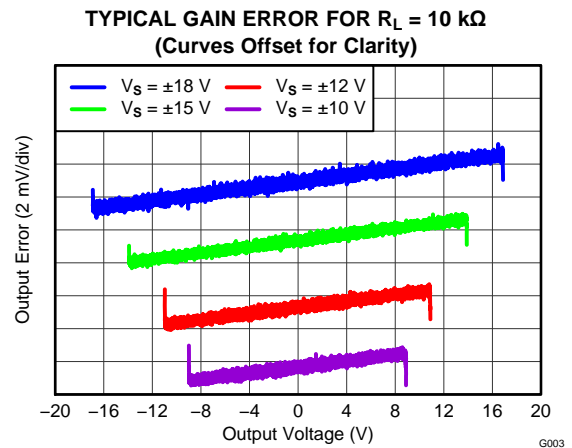

Figure 4.

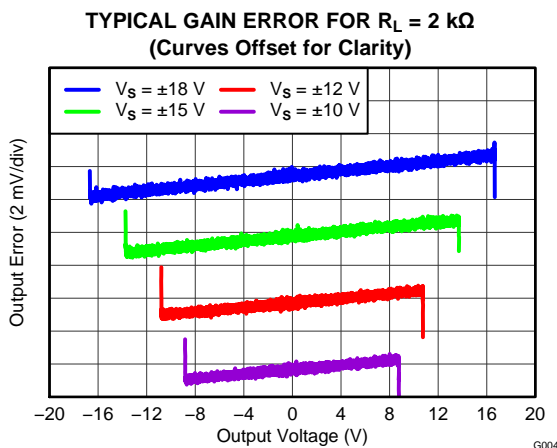

Figure 5.

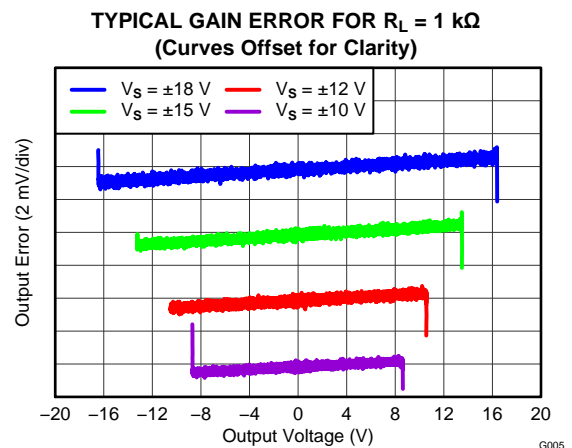

Figure 6.

**TYPICAL CHARACTERISTICS (continued)**

At  $T_A = +25^\circ\text{C}$ ,  $R_L = 2\text{ k}\Omega$  connected to ground, and  $V_S = \pm 15\text{ V}$ , unless otherwise noted.

**TYPICAL GAIN ERROR FOR LOW SUPPLY VOLTAGES  
(Curves Offset for Clarity)**

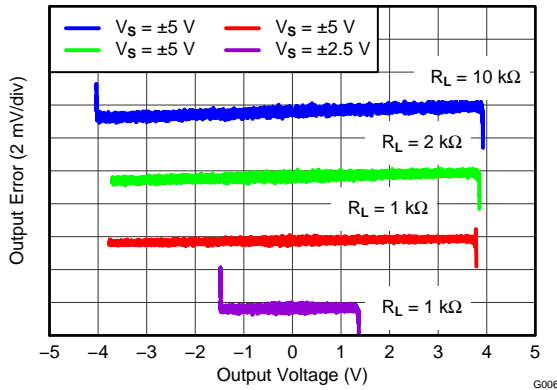

Figure 7.

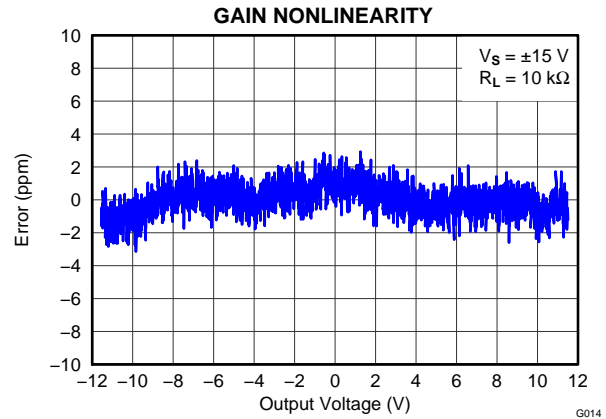

Figure 8.

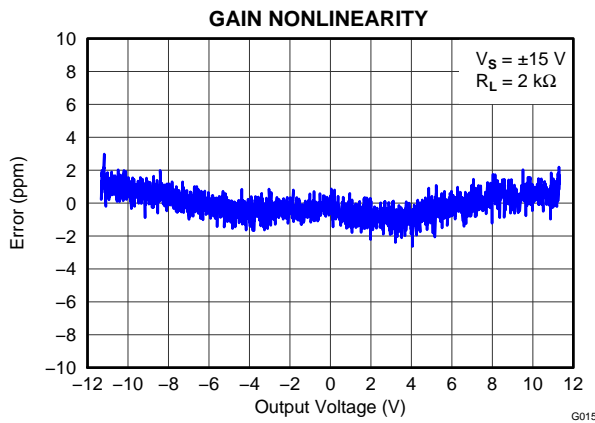

Figure 9.

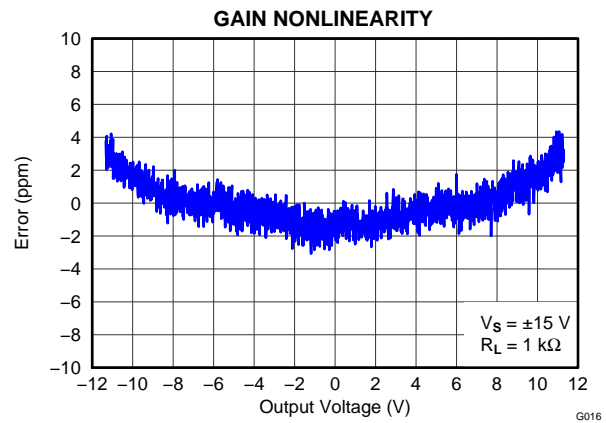

Figure 10.

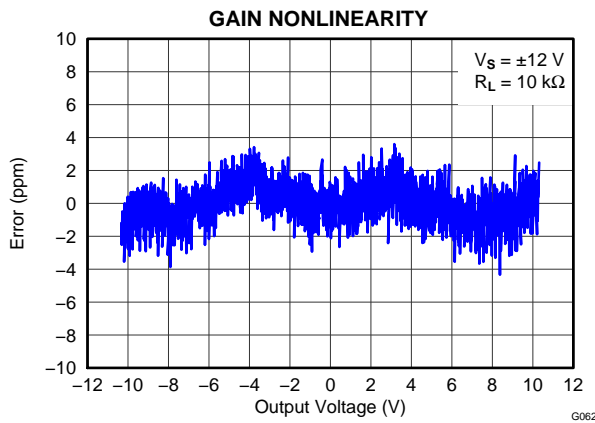

Figure 11.

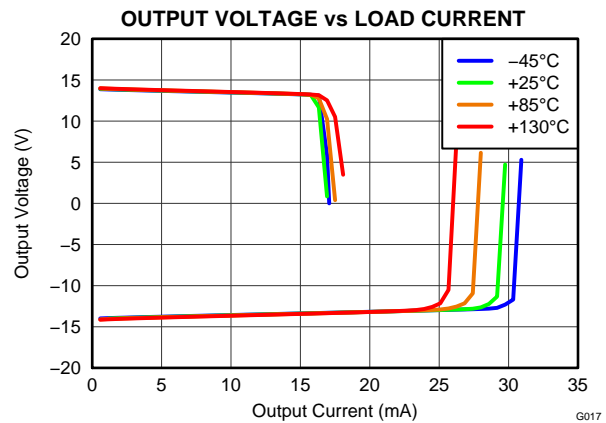

Figure 12.

**TYPICAL CHARACTERISTICS (continued)**

At  $T_A = +25^\circ\text{C}$ ,  $R_L = 2\text{ k}\Omega$  connected to ground, and  $V_S = \pm 15\text{ V}$ , unless otherwise noted.

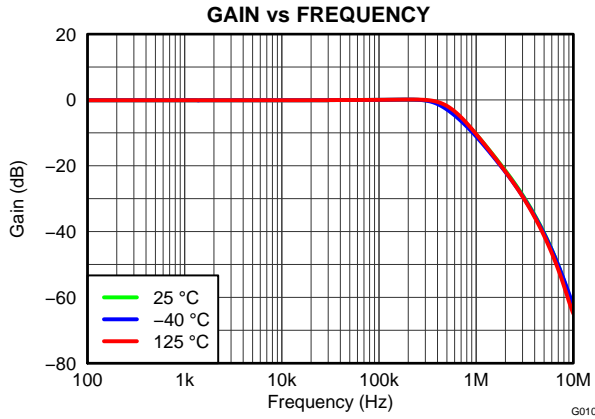

Figure 13.

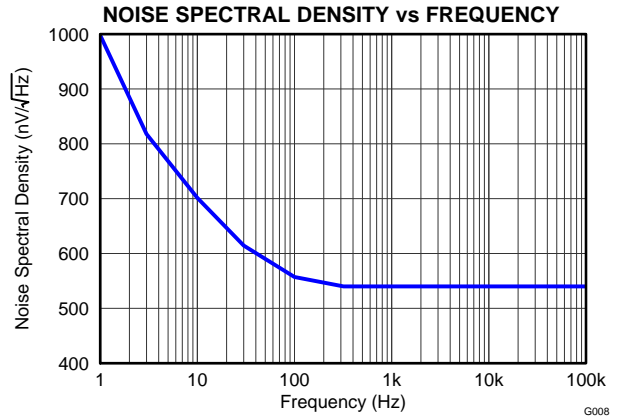

Figure 14.

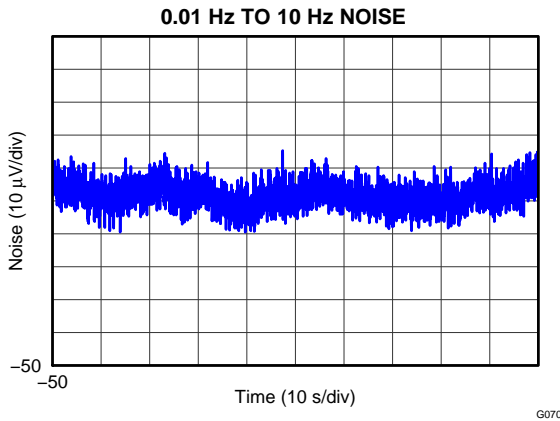

Figure 15.

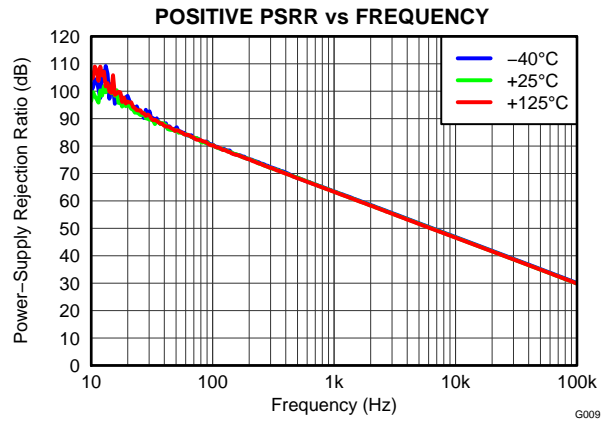

Figure 16.

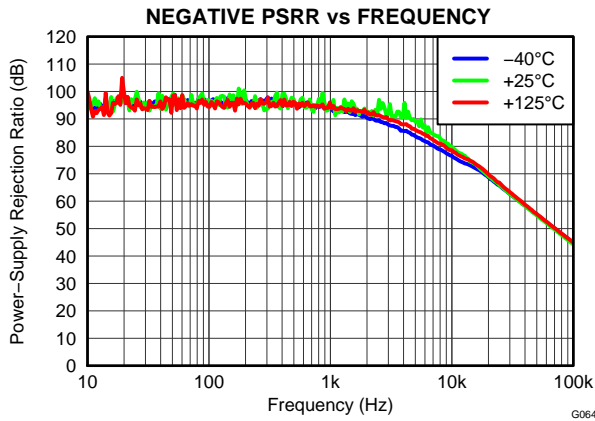

Figure 17.

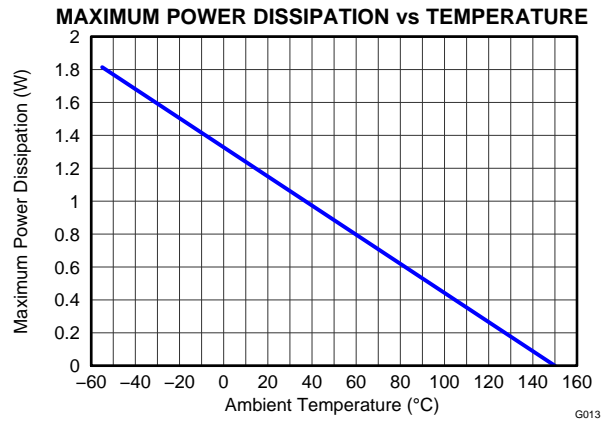

Figure 18.

**TYPICAL CHARACTERISTICS (continued)**

At  $T_A = +25^\circ\text{C}$ ,  $R_L = 2\text{ k}\Omega$  connected to ground, and  $V_S = \pm 15\text{ V}$ , unless otherwise noted.

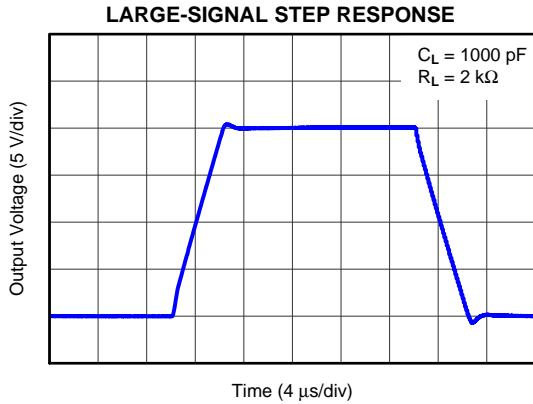

Figure 19.

G011

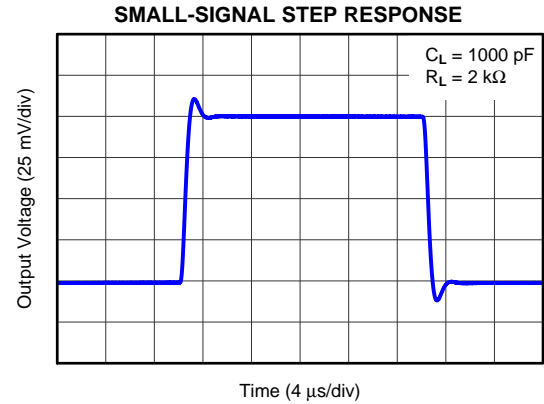

Figure 20.

G012

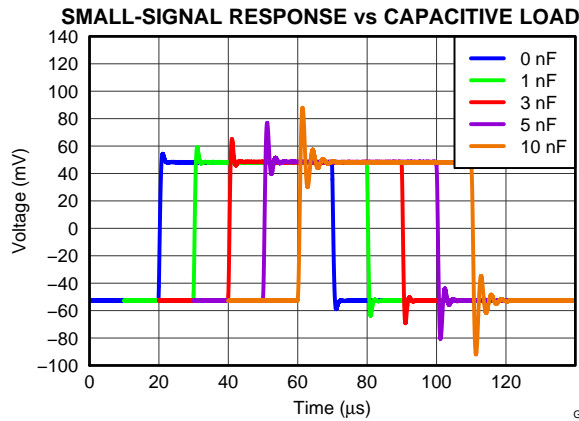

Figure 21.

G065

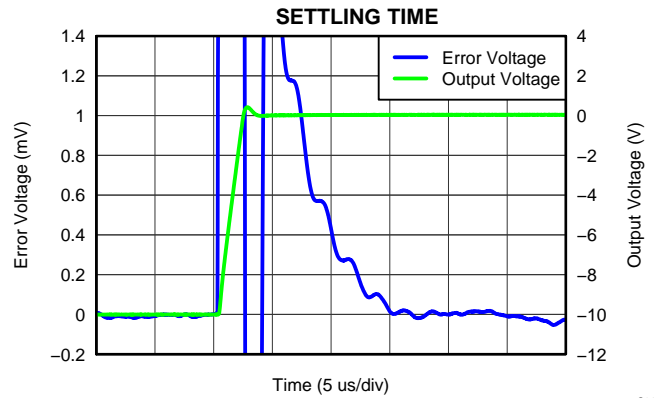

Figure 22.

G018

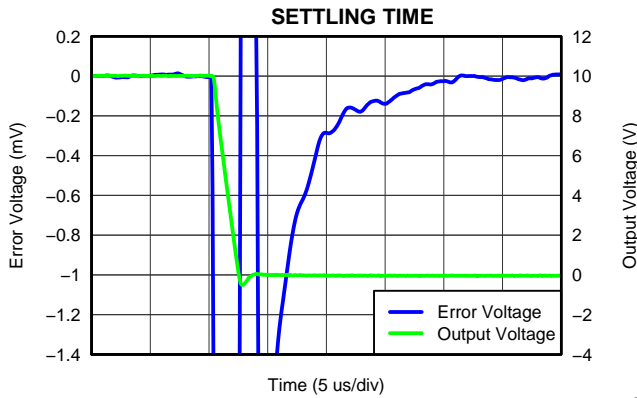

Figure 23.

G063

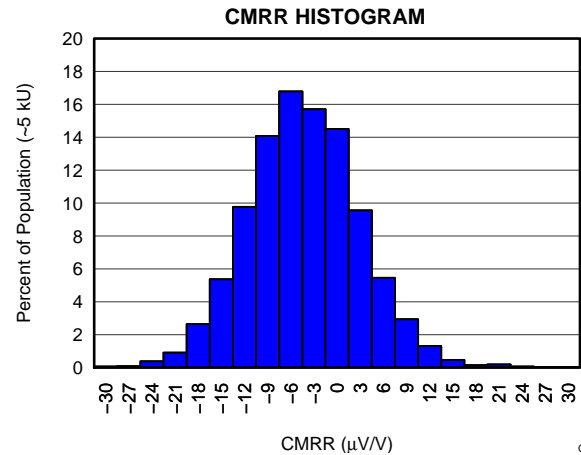

Figure 24.

G019

**TYPICAL CHARACTERISTICS (continued)**

At  $T_A = +25^\circ\text{C}$ ,  $R_L = 2\text{ k}\Omega$  connected to ground, and  $V_S = \pm 15\text{ V}$ , unless otherwise noted.

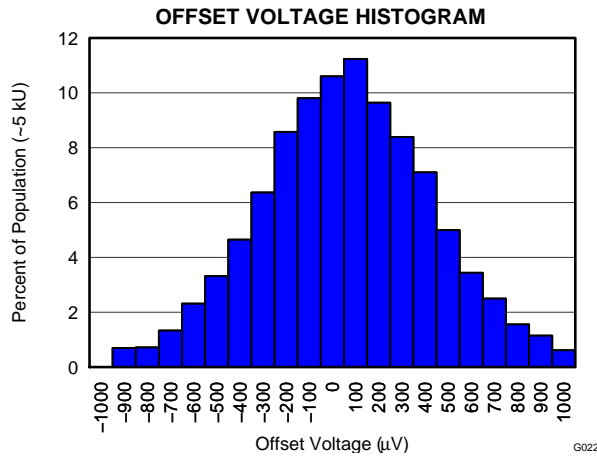

Figure 25.

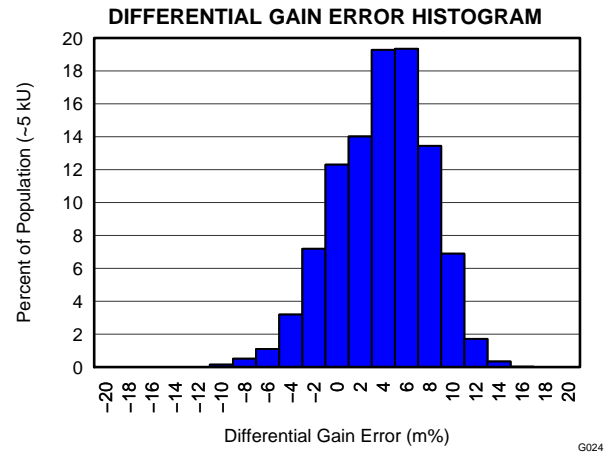

Figure 26.

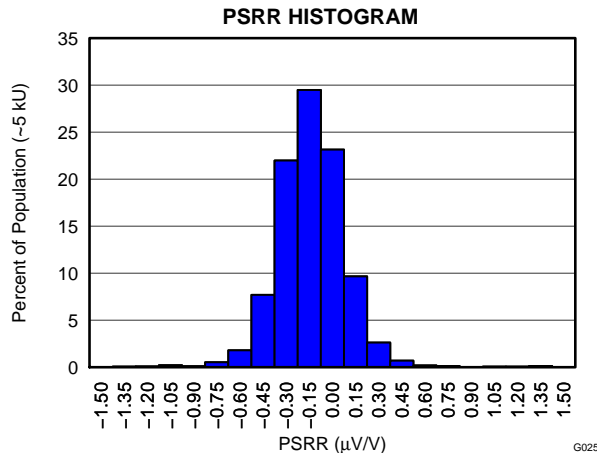

Figure 27.

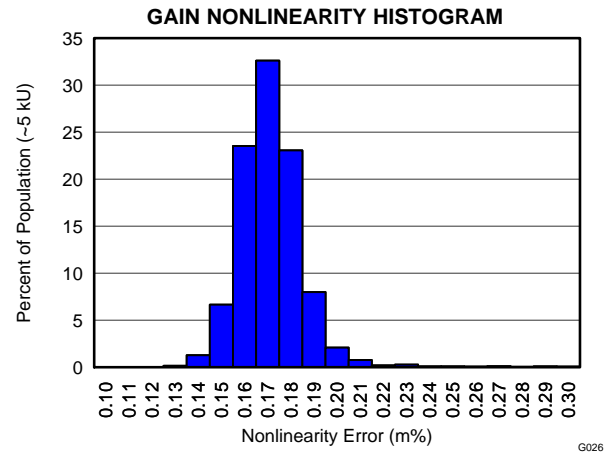

Figure 28.

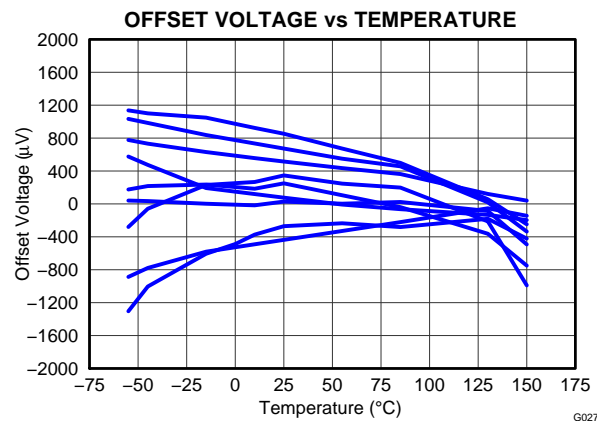

Figure 29.

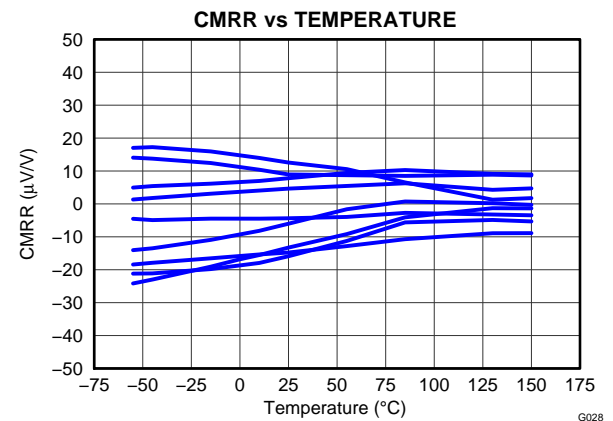
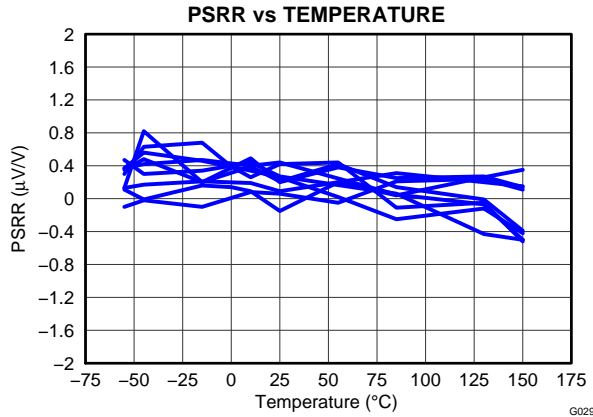

Figure 30.

**TYPICAL CHARACTERISTICS (continued)**

At  $T_A = +25^\circ\text{C}$ ,  $R_L = 2\text{ k}\Omega$  connected to ground, and  $V_S = \pm 15\text{ V}$ , unless otherwise noted.



**Figure 31.**

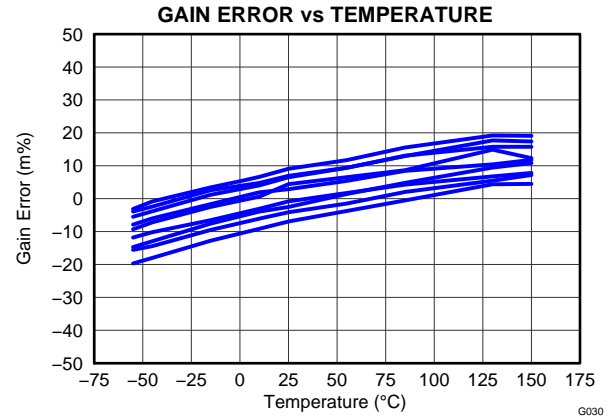

**Figure 32.**

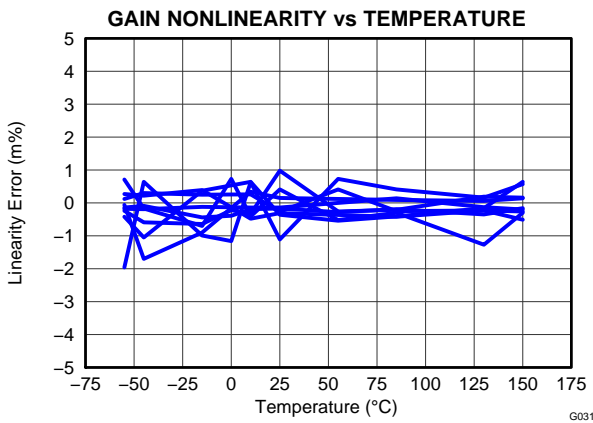

**Figure 33.**

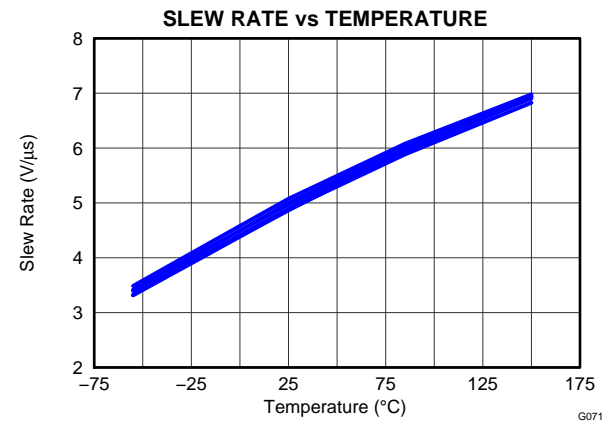

**Figure 34.**

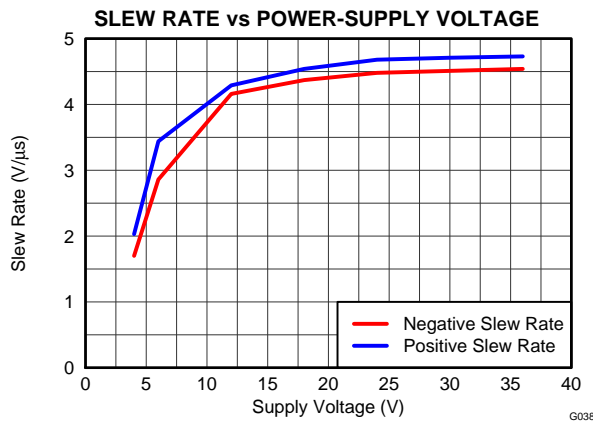

**Figure 35.**

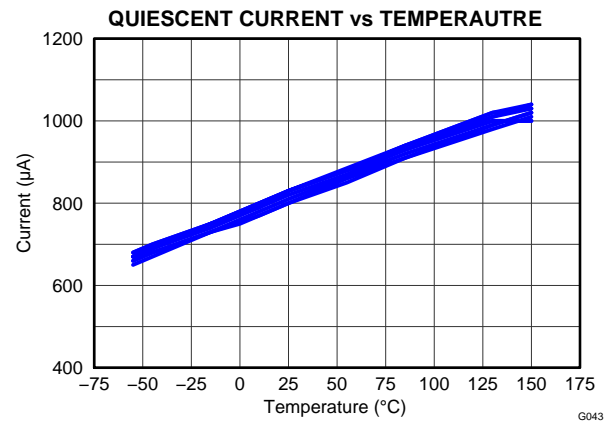

**Figure 36.**

**TYPICAL CHARACTERISTICS (continued)**

At  $T_A = +25^\circ\text{C}$ ,  $R_L = 2\text{ k}\Omega$  connected to ground, and  $V_S = \pm 15\text{ V}$ , unless otherwise noted.

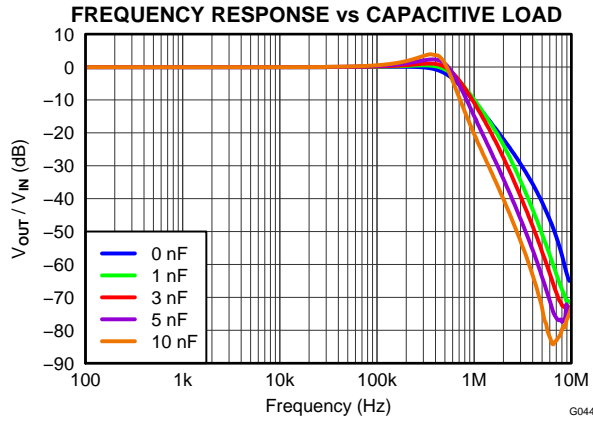

Figure 37.

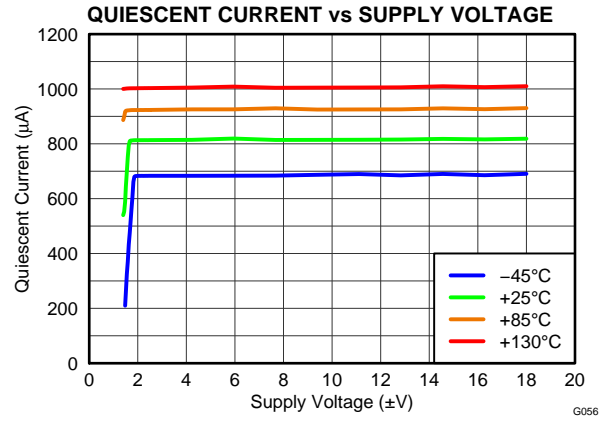

Figure 38.

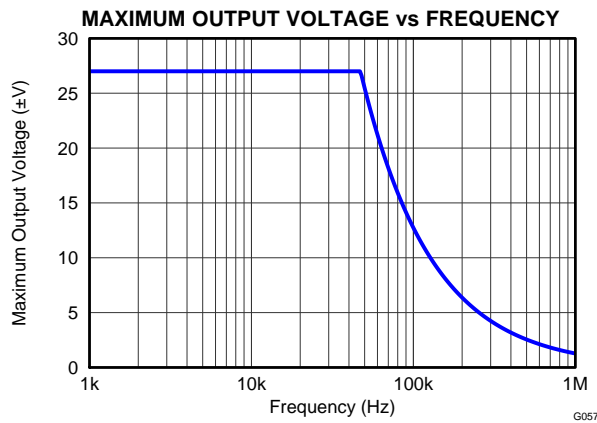

Figure 39.

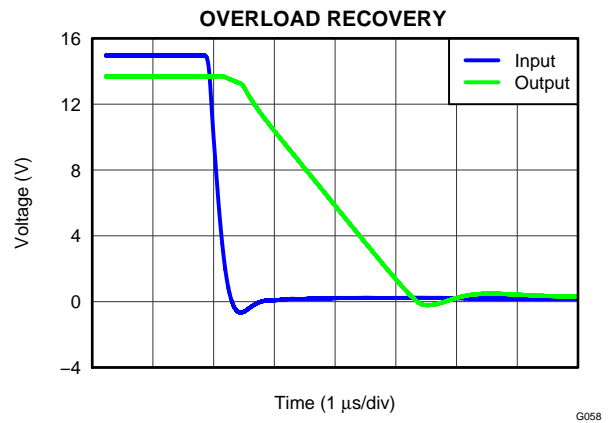

Figure 40.

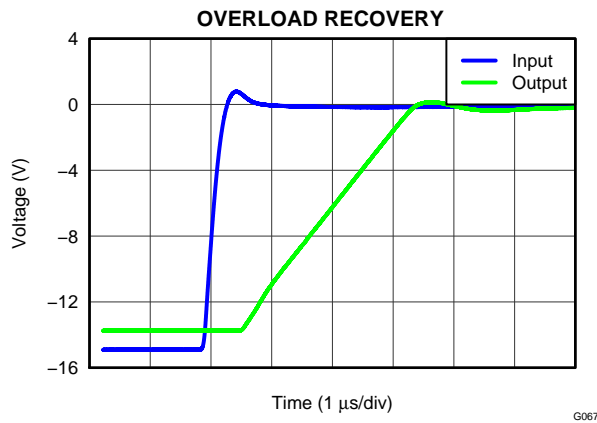

Figure 41.

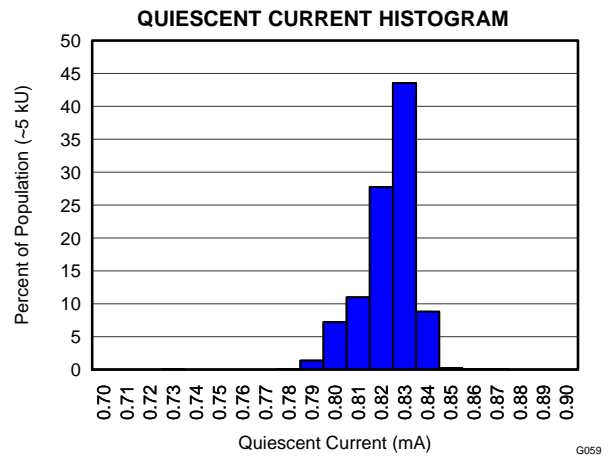
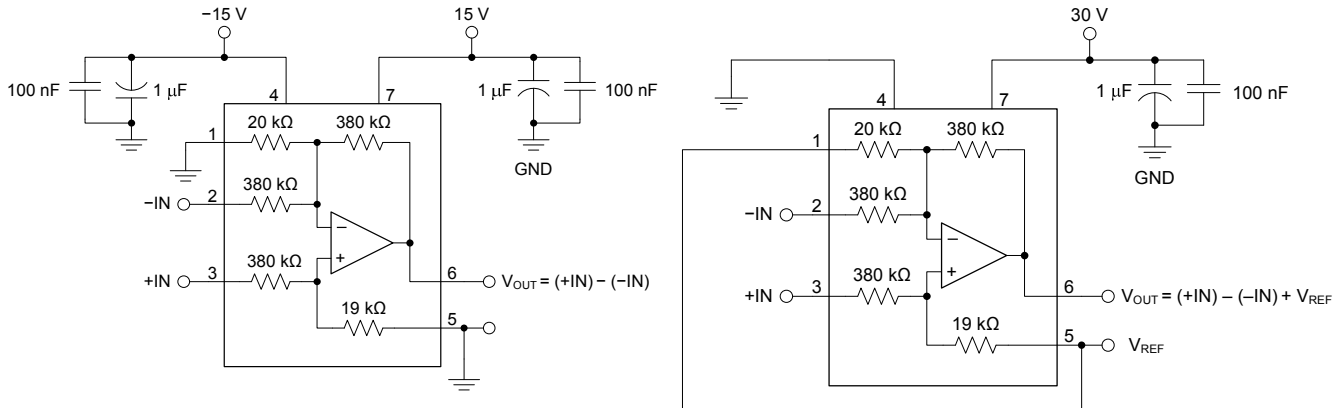

Figure 42.

## APPLICATION INFORMATION

### BASIC INFORMATION

Figure 43 shows the basic connections required for dual-supply operation. Applications with noisy or high-impedance power-supply lines may require decoupling capacitors placed close to the device pins. The output voltage is equal to the differential input voltage between pins 2 and 3. The common-mode input voltage is rejected. Figure 44 shows the basic connections required for single-supply operation.



**Figure 43. Basic Power and Signal Connections for Dual-Supply Operation**

**Figure 44. Basic Power and Signal Connections for Single-Supply Operation**

### TRANSFER FUNCTION

Most applications use the INA149 as a simple unity-gain difference amplifier. The transfer function is given in Equation 1:

$$V_{OUT} = (+IN) - (-IN) \quad (1)$$

Some applications, however, apply voltages to the reference terminals ( $REF_A$  and  $REF_B$ ). The complete transfer function is given in Equation 2:

$$V_{OUT} = (+IN) - (-IN) + 20 \times REF_A - 19 \times REF_B \quad (2)$$

### COMMON-MODE RANGE

The high common-mode range of the INA149 is achieved by dividing down the input signal with a high precision resistor divider. This resistor divider brings both the positive input and the negative input within the input range of the internal operational amplifier. This input range depends on the supply voltage of the INA149.

Both Figure 2 and Figure 3 can be used to determine the maximum common-mode range for a specific supply voltage. The maximum common-mode range can also be calculated by ensuring that both the positive and the negative input of the internal amplifier are within 1.5 V of the supply voltage.

In case the voltage at the inputs of the internal amplifier exceeds the supply voltage, the internal ESD diodes start conducting current. This current must be limited to 10 mA to make sure not to exceed the absolute maximum ratings for the device.

### COMMON-MODE REJECTION

Common-mode rejection (CMR) of the INA149 depends on the input resistor network, which is laser-trimmed for accurate ratio matching. To maintain high CMR, it is important to have low source impedance driving the two inputs. A 75-Ω resistance in series with pins 2 or 3 decreases the common-mode rejection ratio (CMRR) from 100 dB (typical) to 74 dB.

Resistance in series with the reference pins also degrades CMR. A 4-Ω resistance in series with pins 1 or 5 decreases CMRR from 100 dB to 74 dB.

Most applications do not require trimming. Figure 45 shows an optional circuit that may be used for trimming offset voltage and common-mode rejection.

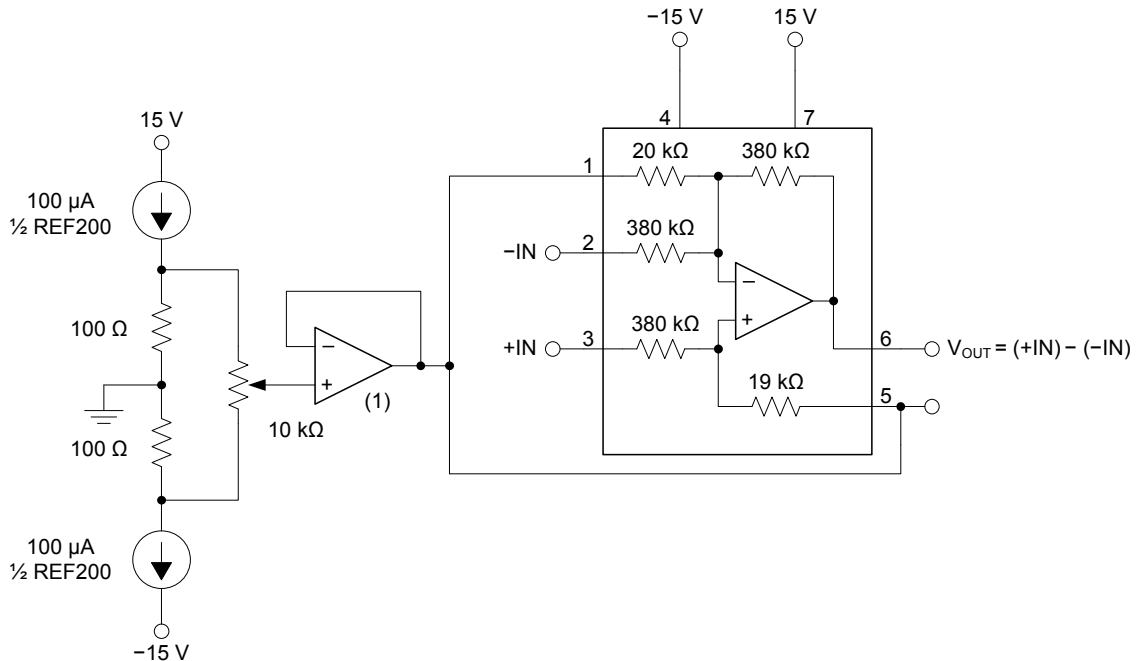

(1) The OPA171 (a 36-V, low-power, RRO, general-purpose operational amplifier) can be used for this application.

**Figure 45. Offset Voltage Trim Circuit**

## MEASURING CURRENT

The INA149 can be used to measure a current by sensing the voltage drop across a series resistor,  $R_S$ . Figure 46 shows the INA149 used to measure the supply currents of a device under test.

The sense resistor imbalances the input resistor matching of the INA149, thus degrading its CMR. Also, the input impedance of the INA149 loads  $R_S$ , causing gain error in the voltage-to-current conversion. Both of these errors can be easily corrected.

The CMR error can be corrected with the addition of a compensation resistor ( $R_C$ ), equal to the value of  $R_S$ , as shown in Figure 46. If  $R_S$  is less than 5  $\Omega$ , degradation in the CMR is negligible and  $R_C$  can be omitted. If  $R_S$  is larger than approximately 1 k $\Omega$ , trimming  $R_C$  may be required to achieve greater than 90-dB CMR. This error is caused by the INA149 input impedance mismatch.

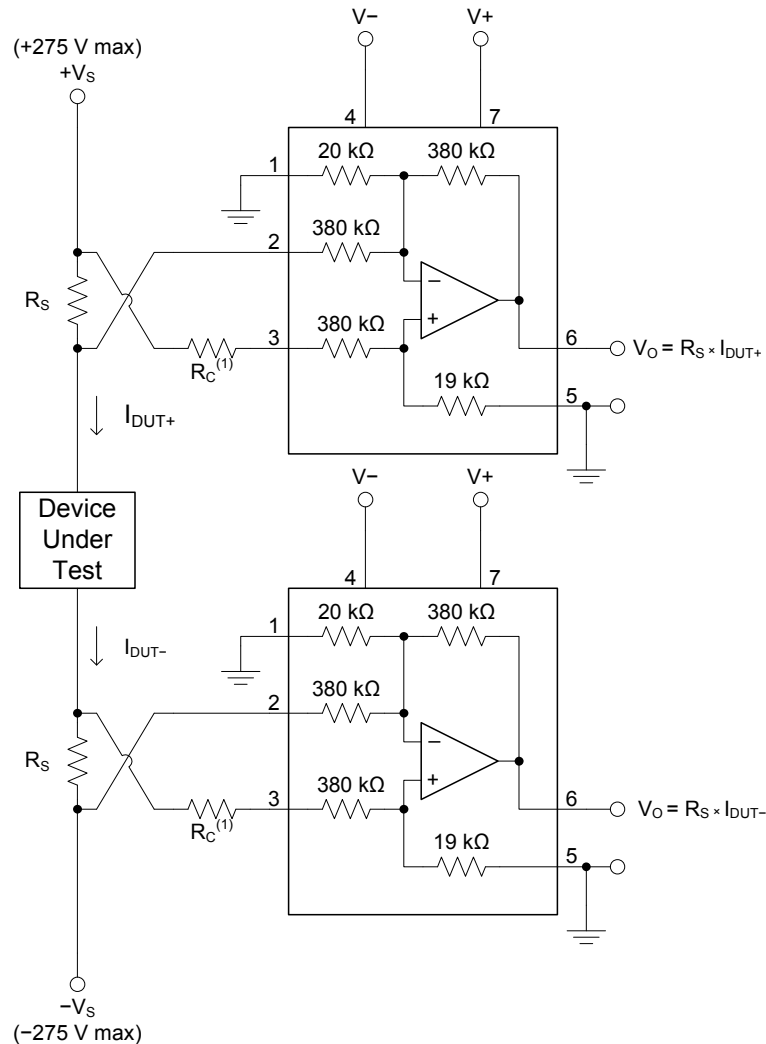

Figure 46. Measuring Supply Currents of a Device Under Test

If  $R_S$  is more than approximately 50  $\Omega$ , the gain error is greater than the 0.02% specification of the INA149. This gain error can be corrected by slightly increasing the value of  $R_S$ . The corrected value ( $R_S'$ ) can be calculated by  $R_S' = R_S \times 380 \text{ k}\Omega / (380 \text{ k}\Omega - R_S)$  (3)

**Example:** For a 1-V/mA transfer function, the nominal, uncorrected value for  $R_S$  would be 1 k $\Omega$ . A slightly larger value ( $R_S' = 1002.6 \Omega$ ), compensates for the gain error as a result of loading.

The 380-k $\Omega$  term in the equation for  $R_S'$  has a tolerance of 25%, thus sense resistors above approximately 400  $\Omega$  may require trimming to achieve gain accuracy better than 0.02%.

## NOISE PERFORMANCE

The wideband noise performance of the INA149 is dominated by the internal resistor network. The thermal or *Johnson noise* of these resistors measures approximately 550 nV/√Hz. The internal op amp contributes virtually no excess noise at frequencies above 100 Hz.

Many applications may be satisfied with less than the full 500-kHz bandwidth of the INA149. In these cases, the noise can be reduced with a low-pass filter on the output. The two-pole filter shown in Figure 47 limits bandwidth and reduces noise. Because the INA149 has a 1/f noise corner frequency of approximately 100 Hz, a cutoff frequency below 100 Hz does not further reduce noise.

Component values for different filter frequencies are shown in Table 1.

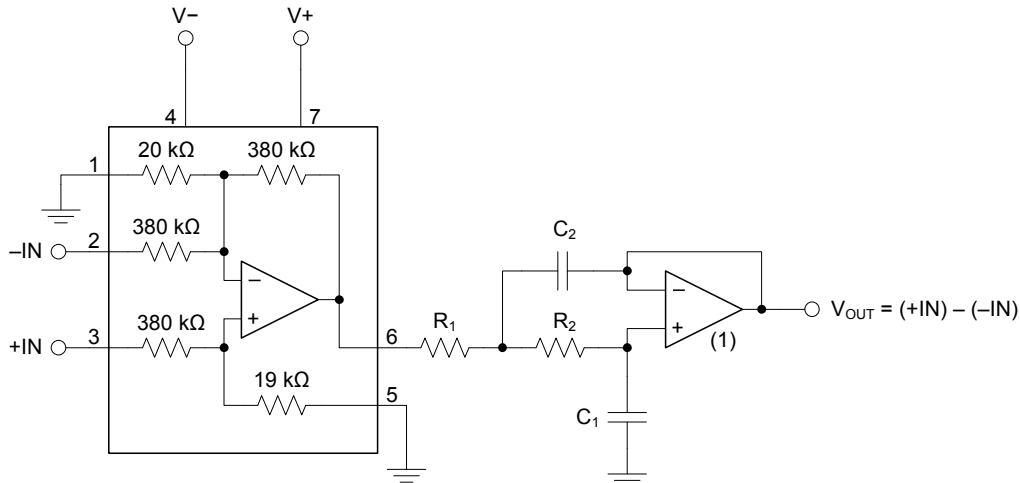

(1) For most applications, the OPA171 can be used as an operational amplifier. For directly driving successive-approximation register (SAR) data converters, the OPA140 is a good choice.

Figure 47. Output Filter for Noise Reduction

Table 1. Components Values for Different Filter Bandwidths

| BUTTERWORTH LOW-PASS (f <sub>-3 dB</sub> ) | OUTPUT NOISE (mV <sub>PP</sub> ) | R <sub>1</sub> | R <sub>2</sub> | C <sub>1</sub> | C <sub>2</sub> |
|--|----------------------------------|----------------|----------------|----------------|----------------|
| 200 kHz                                    | 1.8                              | No filter      |                |                |                |
| 100 kHz                                    | 1.1                              | 11 kΩ          | 11.3 kΩ        | 100 pF         | 200 pF         |
| 10 kHz                                     | 0.35                             | 11 kΩ          | 11.3 kΩ        | 1 nF           | 2 nF           |
| 1 kHz                                      | 0.11                             | 11 kΩ          | 11.3 kΩ        | 10 nF          | 20 nF          |
| 100 Hz                                     | 0.05                             | 11 kΩ          | 11.3 kΩ        | 0.1 μF         | 0.2 μF         |

## ERROR BUDGET ANALYSIS

The following error budget analysis demonstrates the importance of a high common-mode rejection ratio when measuring small differential signals in the presence of high common-mode voltages. Figure 48 shows a typical current measurement application.

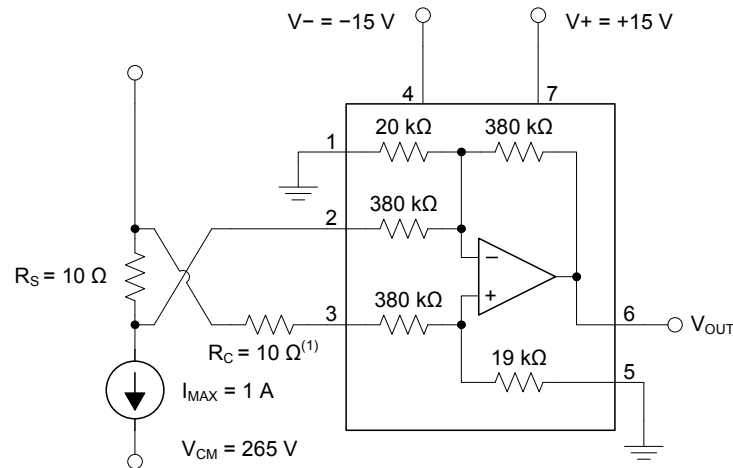

(1) See the [Measuring Current](#) section for details about  $R_C$ .

**Figure 48. Typical Current Measurement Application**

The maximum current through the shunt resistor ( $R_S$ ) is 1 A and generates a full-scale voltage drop of 10 V. All error sources in this calculation are shown in relation to this full-scale voltage. The common-mode voltage in this scenario is 265 V and the temperature range is from room temperature (+25°C) to +85°C. Table 2 shows the dominant error sources for the INA149 and a competitor device.

**Table 2. Error Budget Analysis**

| ERROR SOURCE  | INA149  | COMPETITOR A  | ERROR (ppm of FS) |              |
|---|---|---|-------------------|--------------|
|   |   |   | INA149            | COMPETITOR A |
| <b>Accuracy, <math>T_A = +25^\circ\text{C}</math></b> |   |   |                   |              |
| Initial gain error                                    | 0.02% FS  | 0.05% FS  | 200               | 500          |
| Offset voltage  | 1100 $\mu\text{V}$                                      | 1000 $\mu\text{V}$                                      | 110               | 100          |
| Common mode   | 265 V/90 dB = 8380 $\mu\text{V}$                        | 265 V/77 dB = 37432 $\mu\text{V}$                       | 838               | 3743         |
| <b>Total accuracy error</b>                           |   |   | <b>1148</b>       | <b>4343</b>  |
| <b>Temperature drift</b>                              |   |   |                   |              |
| Gain  | 10 ppm/ $^\circ\text{C} \times 60^\circ\text{C}$        | 10 ppm/ $^\circ\text{C} \times 60^\circ\text{C}$        | 600               | 600          |
| Offset voltage  | 10 $\mu\text{V}/^\circ\text{C} \times 60^\circ\text{C}$ | 20 $\mu\text{V}/^\circ\text{C} \times 60^\circ\text{C}$ | 60                | 120          |
| <b>Total drift error</b>                              |   |   | <b>660</b>        | <b>720</b>   |
| <b>Total error</b>                                    |   |   | <b>1808</b>       | <b>5063</b>  |

If a smaller shunt resistor is used, the full-scale voltage drop is also smaller. A shunt resistor of 1  $\Omega$  causes a 1-V voltage drop with a current of 1 A flowing through it. The error of 1808 ppm for a full-scale voltage of 10 V becomes 18080 ppm (1.6%) for a full-scale voltage of only 1 V.

This example demonstrates that the dominate source of error, even over temperature, comes from the CMRR specification of the devices. The common-mode error is 46% of the total error for the INA149 and 74% of the total error for the competitor device.

### BATTERY CELL VOLTAGE MONITOR

The INA149 can be used to measure the voltages of single cells in a stacked battery pack. Figure 49 shows an examples for such an application.

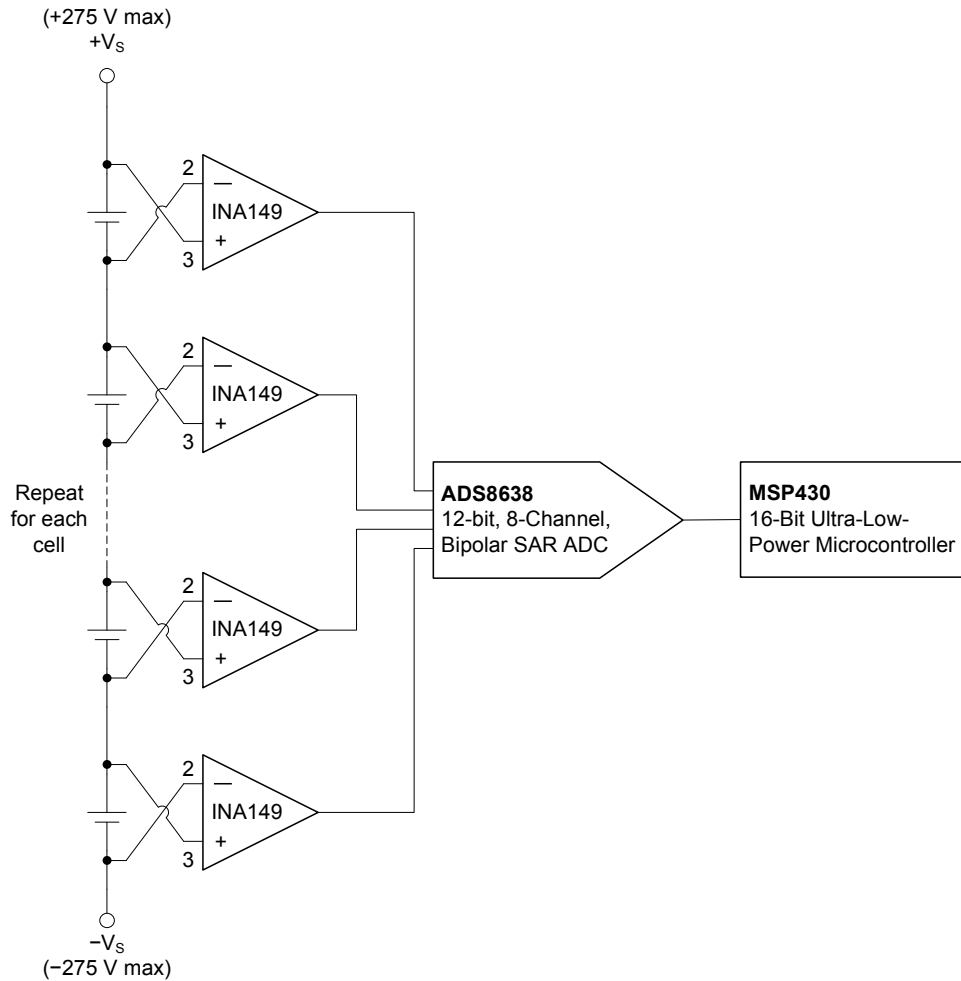



Figure 49. Battery Cell Voltage Monitor

## REVISION HISTORY

NOTE: Page numbers for previous revisions may differ from page numbers in the current version.

| <b>Changes from Revision A (November 2011) to Revision B</b>               | <b>Page</b>       |
|--|-------------------|
| • Changed package marking data in Package/Ordering Information table ..... | <a href="#">2</a> |

**PACKAGING INFORMATION**

| Orderable Device | Status<br>(1) | Package Type | Package<br>Drawing | Pins | Package<br>Qty | Eco Plan<br>(2) | Lead finish/<br>Ball material<br>(6) | MSL Peak Temp<br>(3) | Op Temp (°C) | Device Marking<br>(4/5) | Samples   |
|------------------|---------------|--------------|--------------------|------|----------------|-----------------|--------------------------------------|----------------------|--------------|-------------------------|---|
| INA149AID        | ACTIVE        | SOIC         | D                  | 8    | 75             | RoHS & Green    | NIPDAU                               | Level-2-260C-1 YEAR  | -40 to 125   | INA<br>149A             |  |
| INA149AIDR       | ACTIVE        | SOIC         | D                  | 8    | 2500           | RoHS & Green    | NIPDAU                               | Level-2-260C-1 YEAR  | -40 to 125   | INA<br>149A             |  |

(1) The marketing status values are defined as follows:

**ACTIVE:** Product device recommended for new designs.

**LIFEBUY:** TI has announced that the device will be discontinued, and a lifetime-buy period is in effect.

**NRND:** Not recommended for new designs. Device is in production to support existing customers, but TI does not recommend using this part in a new design.

**PREVIEW:** Device has been announced but is not in production. Samples may or may not be available.

**OBSOLETE:** TI has discontinued the production of the device.

(2) **RoHS:** TI defines "RoHS" to mean semiconductor products that are compliant with the current EU RoHS requirements for all 10 RoHS substances, including the requirement that RoHS substance do not exceed 0.1% by weight in homogeneous materials. Where designed to be soldered at high temperatures, "RoHS" products are suitable for use in specified lead-free processes. TI may reference these types of products as "Pb-Free".

**RoHS Exempt:** TI defines "RoHS Exempt" to mean products that contain lead but are compliant with EU RoHS pursuant to a specific EU RoHS exemption.

**Green:** TI defines "Green" to mean the content of Chlorine (Cl) and Bromine (Br) based flame retardants meet JS709B low halogen requirements of <=1000ppm threshold. Antimony trioxide based flame retardants must also meet the <=1000ppm threshold requirement.

(3) MSL, Peak Temp. - The Moisture Sensitivity Level rating according to the JEDEC industry standard classifications, and peak solder temperature.

(4) There may be additional marking, which relates to the logo, the lot trace code information, or the environmental category on the device.

(5) Multiple Device Markings will be inside parentheses. Only one Device Marking contained in parentheses and separated by a "~" will appear on a device. If a line is indented then it is a continuation of the previous line and the two combined represent the entire Device Marking for that device.

(6) Lead finish/Ball material - Orderable Devices may have multiple material finish options. Finish options are separated by a vertical ruled line. Lead finish/Ball material values may wrap to two lines if the finish value exceeds the maximum column width.

**Important Information and Disclaimer:**The information provided on this page represents TI's knowledge and belief as of the date that it is provided. TI bases its knowledge and belief on information provided by third parties, and makes no representation or warranty as to the accuracy of such information. Efforts are underway to better integrate information from third parties. TI has taken and continues to take reasonable steps to provide representative and accurate information but may not have conducted destructive testing or chemical analysis on incoming materials and chemicals. TI and TI suppliers consider certain information to be proprietary, and thus CAS numbers and other limited information may not be available for release.

In no event shall TI's liability arising out of such information exceed the total purchase price of the TI part(s) at issue in this document sold by TI to Customer on an annual basis.



**TAPE AND REEL INFORMATION**

**QUADRANT ASSIGNMENTS FOR PIN 1 ORIENTATION IN TAPE**

\*All dimensions are nominal

| Device     | Package Type | Package Drawing | Pins | SPQ  | Reel Diameter (mm) | Reel Width W1 (mm) | A0 (mm) | B0 (mm) | K0 (mm) | P1 (mm) | W (mm) | Pin1 Quadrant |
|------------|--------------|-----------------|------|------|--------------------|--------------------|---------|---------|---------|---------|--------|---------------|
| INA149AIDR | SOIC         | D               | 8    | 2500 | 330.0              | 12.4               | 6.4     | 5.2     | 2.1     | 8.0     | 12.0   | Q1            |

**TAPE AND REEL BOX DIMENSIONS**

\*All dimensions are nominal

| Device     | Package Type | Package Drawing | Pins | SPQ  | Length (mm) | Width (mm) | Height (mm) |
|------------|--------------|-----------------|------|------|-------------|------------|-------------|
| INA149AIDR | SOIC         | D               | 8    | 2500 | 853.0       | 449.0      | 35.0        |

**TUBE**

\*All dimensions are nominal

| Device    | Package Name | Package Type | Pins | SPQ | L (mm) | W (mm) | T (μm) | B (mm) |
|-----------|--------------|--------------|------|-----|--------|--------|--------|--------|
| INA149AID | D            | SOIC         | 8    | 75  | 506.6  | 8      | 3940   | 4.32   |



D0008A

# PACKAGE OUTLINE

SOIC - 1.75 mm max height

SMALL OUTLINE INTEGRATED CIRCUIT



4214825/C 02/2019

NOTES:

- Linear dimensions are in inches [millimeters]. Dimensions in parenthesis are for reference only. Controlling dimensions are in inches. Dimensioning and tolerancing per ASME Y14.5M.
- This drawing is subject to change without notice.
- This dimension does not include mold flash, protrusions, or gate burrs. Mold flash, protrusions, or gate burrs shall not exceed .006 [0.15] per side.
- This dimension does not include interlead flash.
- Reference JEDEC registration MS-012, variation AA.

# EXAMPLE BOARD LAYOUT

D0008A

SOIC - 1.75 mm max height

SMALL OUTLINE INTEGRATED CIRCUIT



LAND PATTERN EXAMPLE  
 EXPOSED METAL SHOWN  
 SCALE:8X



SOLDER MASK DETAILS

4214825/C 02/2019

NOTES: (continued)

- 6. Publication IPC-7351 may have alternate designs.
- 7. Solder mask tolerances between and around signal pads can vary based on board fabrication site.

# EXAMPLE STENCIL DESIGN

D0008A

SOIC - 1.75 mm max height

SMALL OUTLINE INTEGRATED CIRCUIT



SOLDER PASTE EXAMPLE  
BASED ON .005 INCH [0.125 MM] THICK STENCIL  
SCALE:8X

4214825/C 02/2019

NOTES: (continued)

8. Laser cutting apertures with trapezoidal walls and rounded corners may offer better paste release. IPC-7525 may have alternate design recommendations.
9. Board assembly site may have different recommendations for stencil design.

## 重要声明和免责声明

TI“按原样”提供技术和可靠性数据（包括数据表）、设计资源（包括参考设计）、应用或其他设计建议、网络工具、安全信息和其他资源，不保证没有瑕疵且不做任何明示或暗示的担保，包括但不限于对适销性、某特定用途方面的适用性或不侵犯任何第三方知识产权的暗示担保。

这些资源可供使用 TI 产品进行设计的熟练开发人员使用。您将自行承担以下全部责任：(1) 针对您的应用选择合适的 TI 产品，(2) 设计、验证并测试您的应用，(3) 确保您的应用满足相应标准以及任何其他功能安全、信息安全、监管或其他要求。

这些资源如有变更，恕不另行通知。TI 授权您仅可将这些资源用于研发本资源所述的 TI 产品的应用。严禁对这些资源进行其他复制或展示。您无权使用任何其他 TI 知识产权或任何第三方知识产权。您应全额赔偿因在这些资源的使用中对 TI 及其代表造成的任何索赔、损害、成本、损失和债务，TI 对此概不负责。

TI 提供的产品受 [TI 的销售条款](#) 或 [ti.com](#) 上其他适用条款/TI 产品随附的其他适用条款的约束。TI 提供这些资源并不会扩展或以其他方式更改 TI 针对 TI 产品发布的适用的担保或担保免责声明。

TI 反对并拒绝您可能提出的任何其他或不同的条款。

邮寄地址：Texas Instruments, Post Office Box 655303, Dallas, Texas 75265

Copyright © 2022，德州仪器 (TI) 公司