

Low-Power BiCMOS Current-Mode PWM

FEATURES

- 100 μ A Typical Starting Supply Current
- 500 μ A Typical Operating Supply Current
- Operation to 1MHz
- Internal Soft Start
- Internal Fault Soft Start
- Internal Leading-Edge Blanking of the Current Sense Signal
- 1 Amp Totem-Pole Output
- 70ns Typical Response from Current-Sense to Gate Drive Output
- 1.5% Tolerance Voltage Reference
- Same Pinout as UC3842 and UC3842A

DESCRIPTION

The UCC1800/1/2/3/4/5 family of high-speed, low-power integrated circuits contain all of the control and drive components required for off-line and DC-to-DC fixed frequency current-mode switching power supplies with minimal parts count.

These devices have the same pin configuration as the UC1842/3/4/5 family, and also offer the added features of internal full-cycle soft start and internal leading-edge blanking of the current-sense input.

The UCC1800/1/2/3/4/5 family offers a variety of package options, temperature range options, choice of maximum duty cycle, and choice of critical voltage levels. Lower reference parts such as the UCC1803 and UCC1805 fit best into battery operated systems, while the higher reference and the higher UVLO hysteresis of the UCC1802 and UCC1804 make these ideal choices for use in off-line power supplies.

The UCC180x series is specified for operation from -55°C to $+125^{\circ}\text{C}$, the UCC280x series is specified for operation from -40°C to $+85^{\circ}\text{C}$, and the UCC380x series is specified for operation from 0°C to $+70^{\circ}\text{C}$.

Part Number	Maximum Duty Cycle	Reference Voltage	Turn-On Threshold	Turn-Off Threshold
UCCx800	100%	5V	7.2V	6.9V
UCCx801	50%	5V	9.4V	7.4V
UCCx802	100%	5V	12.5V	8.3V
UCCx803	100%	4V	4.1V	3.6V
UCCx804	50%	5V	12.5V	8.3V
UCCx805	50%	4V	4.1V	3.6V

BLOCK DIAGRAM

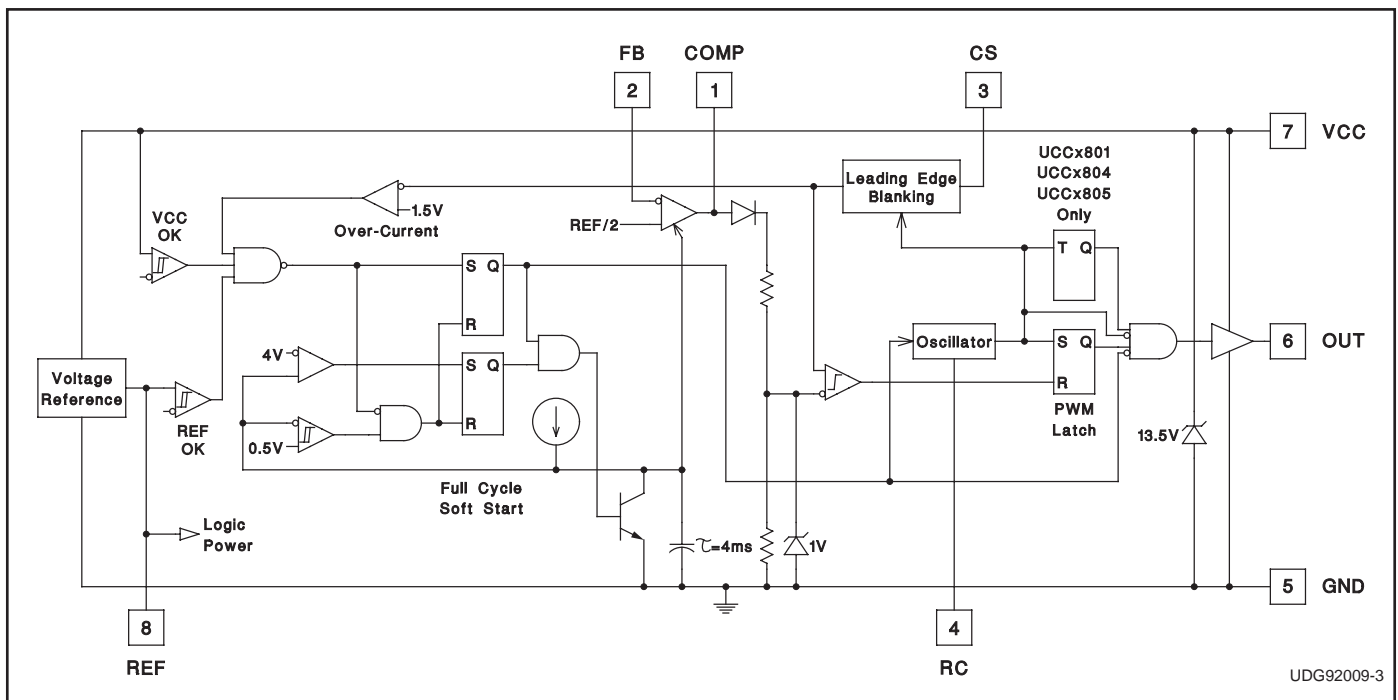

ABSOLUTE MAXIMUM RATINGS (Note 1)

V _{CC} Voltage (Note 2)	12.0V
V _{CC} Current (Note 2)	30.0mA
OUT Current	±1.0A
OUT Energy (Capacitive Load)	20.0μJ
Analog Inputs (FB, CS)	-0.3V to 6.3V
Power Dissipation at T _A < +25°C (N or J Package)	1.0W
Power Dissipation at T _A < +25°C (D Package)	0.65W
Power Dissipation at T _A < +25°C (L Package)	1.375W
Storage Temperature Range	-65°C to +150°C
Lead Temperature (Soldering, 10 Seconds)	+300°C

Note 1: Values beyond which damage may occur. All voltages are with respect to GND. All currents are positive into the specified terminal. Consult Unitrode databook for information regarding thermal specifications and limitations of packages.

Note 2: In normal operation V_{CC} is powered through a current limiting resistor. Absolute maximum of 12V applies when V_{CC} is driven from a low impedance source such that I_{CC} does not exceed 30mA (which includes gate drive current requirement). The resistor should be sized so that the V_{CC} voltage, under operating conditions is below 12V but above the turn off threshold.

TEMPERATURE AND PACKAGE SELECTION

	Temperature Range	Available Packages
UCC180X	-55°C to +125°C	J, L
UCC280X	-40°C to +85°C	N, D, PW
UCC380X	0°C to +70°C	N, D, PW

ORDERING INFORMATION

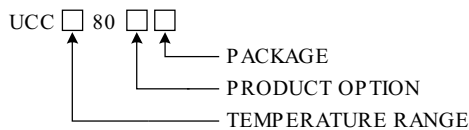

CONNECTION DIAGRAMS

TSSOP-8 (Top View) PW Package

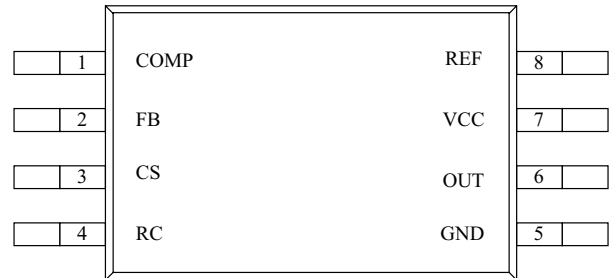

DIL-8, SOIC-8 (Top View) J or N, D Package

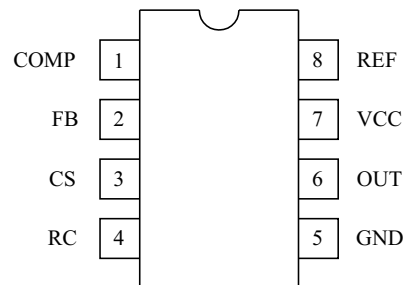

LCC-20 (TOP VIEW) L Package

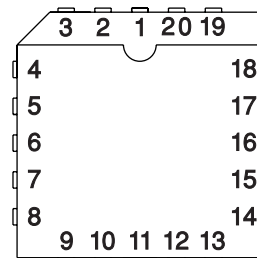

PACKAGE PIN FUNCTION	
FUNCTION	PIN
N/C	1
Comp	2
N/C	3-4
FB	5
N/C	6
CS	7
N/C	8-9
RC	10
N/C	11
PWR GND	12
GND	13
N/C	14
OUT	15
N/C	16
VCC	17
N/C	18-19
REF	20

ELECTRICAL CHARACTERISTICS Unless otherwise stated, these specifications apply for $-55^{\circ}\text{C} \leq T_A \leq +125^{\circ}\text{C}$ for UCC180x; $-40^{\circ}\text{C} \leq T_A \leq +85^{\circ}\text{C}$ for UCC280x; $0^{\circ}\text{C} \leq T_A \leq +70^{\circ}\text{C}$ for UCC380x; $V_{CC}=10\text{V}$ (Note 3); $R_T=100\text{k}$ from REF to RC; $C_T=330\text{pF}$ from RC to GND; 0.1 F capacitor from V_{CC} to GND; 0.1 F capacitor from V_{REF} to GND. $T_A=T_J$.

PARAMETER	TEST CONDITIONS	UCC180X UCC280X			UCC380X			UNITS
		MIN	TYP	MAX	MIN	TYP	MAX	
Reference Section								
Output Voltage	$T_J=+25^{\circ}\text{C}$, $I=0.2\text{mA}$, UCCx800/1/2/4	4.925	5.00	5.075	4.925	5.00	5.075	V
	$T_J=+25^{\circ}\text{C}$, $I=0.2\text{mA}$, UCCx803/5	3.94	4.00	4.06	3.94	4.00	4.06	
Load Regulation	$0.2\text{mA} < I < 5\text{mA}$		10	30		10	25	mV
Line Regulation	$T_J=+25^{\circ}\text{C}$, $V_{CC}=10\text{V}$ to Clamp ($I_{VCC}=25\text{mA}$)			1.9			1.9	mV/V
	$T_J=-55^{\circ}\text{C}$ to $+125^{\circ}\text{C}$, $V_{CC}=10\text{V}$ to Clamp ($I_{VCC}=25\text{mA}$)			2.5			2.1	mV/V
Total Variation	UCCx800/1/2/4 (Note 7)	4.88	5.00	5.10	4.88	5.00	5.10	V
	UCCx803/5 (Note 7)	3.90	4.00	4.08	3.90	4.00	4.08	V
Output Noise Voltage	$10\text{Hz} \leq f \leq 10\text{kHz}$, $T_J=+25^{\circ}\text{C}$ (Note 9)		130			130		μV
Long Term Stability	$T_A=+125^{\circ}\text{C}$, 1000 Hours (Note 9)		5			5		mV
Output Short Circuit		-5		-35	-5		-35	mA
Oscillator Section								
Oscillator Frequency	UCCx800/1/2/4 (Note 4)	40	46	52	40	46	52	kHz
	UCCx803/5 (Note 4)	26	31	36	26	31	36	
Temperature Stability	(Note 9)		2.5			2.5		%
Amplitude peak-to-peak		2.25	2.40	2.55	2.25	2.40	2.55	V
Oscillator Peak Voltage			2.45			2.45		V
Error Amplifier Section								
Input Voltage	COMP=2.5V; UCCx800/1/2/4	2.44	2.50	2.56	2.44	2.50	2.56	V
	COMP=2.0V; UCCx803/5	1.95	2.0	2.05	1.95	2.0	2.05	
Input Bias Current		-1		1	-1		1	μA
Open Loop Voltage Gain		60	80		60	80		dB
COMP Sink Current	FB=2.7V, COMP=1.1V	0.3		3.5	0.4		2.5	mA
COMP Source Current	FB=1.8V, COMP=REF-1.2V	-0.2	-0.5	-0.8	-0.2	-0.5	-0.8	mA
Gain Bandwidth Product	(Note 9)		2			2		MHz
PWM Section								
Maximum Duty Cycle	UCCx800/2/3	97	99	100	97	99	100	%
	UCCx801/4/5	48	49	50	48	49	50	
Minimum Duty Cycle	COMP=0V			0			0	%
Current Sense Section								
Gain	(Note 5)	1.10	1.65	1.80	1.10	1.65	1.80	V/V
Maximum Input Signal	COMP=5V (Note 6)	0.9	1.0	1.1	0.9	1.0	1.1	V
Input Bias Current		-200		200	-200		200	nA
CS Blank Time		50	100	150	50	100	150	ns
Over-Current Threshold		1.42	1.55	1.68	1.42	1.55	1.68	V
COMP to CS Offset	CS=0V	0.45	0.90	1.35	0.45	0.90	1.35	V

ELECTRICAL CHARACTERISTICS Unless otherwise stated, these specifications apply for $-55^{\circ}\text{C} \leq T_A \leq +125^{\circ}\text{C}$ for UCC180x; $-40^{\circ}\text{C} \leq T_A \leq +85^{\circ}\text{C}$ for UCC280x; $0^{\circ}\text{C} \leq T_A \leq +70^{\circ}\text{C}$ for UCC380x; $V_{CC}=10\text{V}$ (Note 3); $RT=100\text{k}$ from REF to RC; $CT=330\text{pF}$ from RC to GND; $0.1 \mu\text{F}$ capacitor from V_{CC} to GND; $0.1 \mu\text{F}$ capacitor from V_{REF} to GND. $T_A=T_J$.

PARAMETER	TEST CONDITIONS	UCC180X UCC280X			UCC380X			UNITS
Output Section								
OUT Low Level	I=20mA, all parts		0.1	0.4		0.1	0.4	V
	I=200mA, all parts		0.35	0.90		0.35	0.90	V
	I=50mA, VCC=5V, UCCx803/5		0.15	0.40		0.15	0.40	V
	I=20mA, VCC=0V, all parts		0.7	1.2		0.7	1.2	V
OUT High V_{SAT} (V_{CC} -OUT)	I=-20mA, all parts		0.15	0.40		0.15	0.40	V
	I=-200mA, all parts		1.0	1.9		1.0	1.9	V
	I=-50mA, VCC=5V, UCCx803/5		0.4	0.9		0.4	0.9	V
Rise Time	$C_L=1\text{nF}$		41	70		41	70	ns
Fall Time	$C_L=1\text{nF}$		44	75		44	75	ns
Undervoltage Lockout Section								
Start Threshold (Note 8)	UCCx800	6.6	7.2	7.8	6.6	7.2	7.8	V
	UCCx801	8.6	9.4	10.2	8.6	9.4	10.2	V
	UCCx802/4	11.5	12.5	13.5	11.5	12.5	13.5	V
	UCCx803/5	3.7	4.1	4.5	3.7	4.1	4.5	V
Stop Threshold (Note 8)	UCCx1800	6.3	6.9	7.5	6.3	6.9	7.5	V
	UCCx1801	6.8	7.4	8.0	6.8	7.4	8.0	V
	UCCx802/4	7.6	8.3	9.0	7.6	8.3	9.0	V
	UCCx803/5	3.2	3.6	4.0	3.2	3.6	4.0	V
Undervoltage Lockout Section (cont.)								
Start to Stop Hysteresis	UCCx800	0.12	0.3	0.48	0.12	0.3	0.48	V
	UCCx801	1.6	2	2.4	1.6	2	2.4	V
	UCCx802/4	3.5	4.2	5.1	3.5	4.2	5.1	V
	UCCx803/5	0.2	0.5	0.8	0.2	0.5	0.8	V
Soft Start Section								
COMP Rise Time	FB=1.8V, Rise from 0.5V to REF-1V		4	10		4	10	ms
Overall Section								
Start-up Current	$V_{CC} < \text{Start Threshold}$		0.1	0.2		0.1	0.2	mA
Operating Supply Current	FB=0V, CS=0V		0.5	1.0		0.5	1.0	mA
VCC Internal Zener Voltage	$I_{CC}=10\text{mA}$ (Note 8), (Note 10)	12	13.5	15	12	13.5	15	V
VCC Internal Zener Voltage Minus Start Threshold Voltage	UCCx802/4 (Note 8)	0.5	1.0		0.5	1.0		V

Note 3: Adjust VCC above the start threshold before setting at 10V.

Note 4: Oscillator frequency for the UCCx800, UCCx802 and UCCx803 is the output frequency.

Oscillator frequency for the UCCx801, UCCx804 and UCCx805 is twice the output frequency.

Note 5: Gain is defined by: $A = \frac{\Delta V_{COMP}}{\Delta V_{CS}}$ $0 \leq V_{CS} \leq 0.8V$.

Note 6: Parameter measured at trip point of latch with Pin 2 at 0V.

Note 7: Total Variation includes temperature stability and load regulation.

Note 8: Start Threshold, Stop Threshold and Zener Shunt Thresholds track one another.

Note 9: Guaranteed by design. Not 100% tested in production.

Note 10: The device is fully operating in clamp mode as the forcing current is higher than the normal operating supply current.

PIN DESCRIPTIONS

COMP: COMP is the output of the error amplifier and the input of the PWM comparator.

Unlike other devices, the error amplifier in the UCC3800 family is a true, low output-impedance, 2MHz operational amplifier. As such, the COMP terminal can both source and sink current. However, the error amplifier is internally current limited, so that you can command zero duty cycle by externally forcing COMP to GND.

The UCC3800 family features built-in full cycle Soft Start. Soft Start is implemented as a clamp on the maximum COMP voltage.

CS: CS is the input to the current sense comparators. The UCC3800 family has two different current sense comparators: the PWM comparator and an over-current comparator.

The UCC3800 family contains digital current sense filtering, which disconnects the CS terminal from the current sense comparator during the 100ns interval immediately following the rising edge of the OUT pin. This digital filtering, also called leading-edge blanking, means that in most applications, no analog filtering (RC filter) is required on CS. Compared to an external RC filter technique, the leading-edge blanking provides a smaller effective CS to OUT propagation delay. Note, however, that the minimum non-zero On-Time of the OUT signal is directly affected by the leading-edge-blanking and the CS to OUT propagation delay.

The over-current comparator is only intended for fault sensing, and exceeding the over-current threshold will cause a soft start cycle.

FB: FB is the inverting input of the error amplifier. For best stability, keep FB lead length as short as possible and FB stray capacitance as small as possible.

GND: GND is reference ground and power ground for all functions on this part.

OUT: OUT is the output of a high-current power driver capable of driving the gate of a power MOSFET with peak currents exceeding $\pm 750\text{mA}$. OUT is actively held low when V_{CC} is below the UVLO threshold.

The high-current power driver consists of FET output devices, which can switch all of the way to GND and all of the way to V_{CC} . The output stage also provides a very low impedance to overshoot and undershoot. This means that in many cases, external schottky clamp diodes are not required.

RC: RC is the oscillator timing pin. For fixed frequency operation, set timing capacitor charging current by connecting a resistor from REF to RC. Set frequency by connecting a timing capacitor from RC to GND. For best

performance, keep the timing capacitor lead to GND as short and direct as possible. If possible, use separate ground traces for the timing capacitor and all other functions.

The frequency of oscillation can be estimated with the following equations:

$$\text{UCCx800/1/2/4: } F = \frac{1.5}{R \cdot C}$$

$$\text{UCCx803, UCCx805: } F = \frac{1.0}{R \cdot C}$$

where frequency is in Hz, resistance is in ohms, and capacitance is in farads. The recommended range of timing resistors is between 10k and 200k and timing capacitor is 100pF to 1000pF. Never use a timing resistor less than 10k.

To prevent noise problems, bypass V_{CC} to GND with a ceramic capacitor as close to the V_{CC} pin as possible. An electrolytic capacitor may also be used in addition to the ceramic capacitor.

REF: REF is the voltage reference for the error amplifier and also for many other functions on the IC. REF is also used as the logic power supply for high speed switching logic on the IC.

When V_{CC} is greater than 1V and less than the UVLO threshold, REF is pulled to ground through a 5k ohm resistor. This means that REF can be used as a logic output indicating power system status. It is important for reference stability that REF is bypassed to GND with a ceramic capacitor as close to the pin as possible. An electrolytic capacitor may also be used in addition to the ceramic capacitor. A minimum of 0.1 μF ceramic is required. Additional REF bypassing is required for external loads greater than 2.5mA on the reference.

To prevent noise problems with high speed switching transients, bypass REF to ground with a ceramic capacitor very close to the IC package.

VCC: V_{CC} is the power input connection for this device. In normal operation V_{CC} is powered through a current limiting resistor. Although quiescent V_{CC} current is very low, total supply current will be higher, depending on OUT current. Total V_{CC} current is the sum of quiescent V_{CC} current and the average OUT current. Knowing the operating frequency and the MOSFET gate charge (Q_g), average OUT current can be calculated from:

$$I_{OUT} = Q_g \times F.$$

There should be a minimum of 1.0 μF in parallel with a 0.1 μF ceramic capacitor from V_{CC} to ground located close to the device

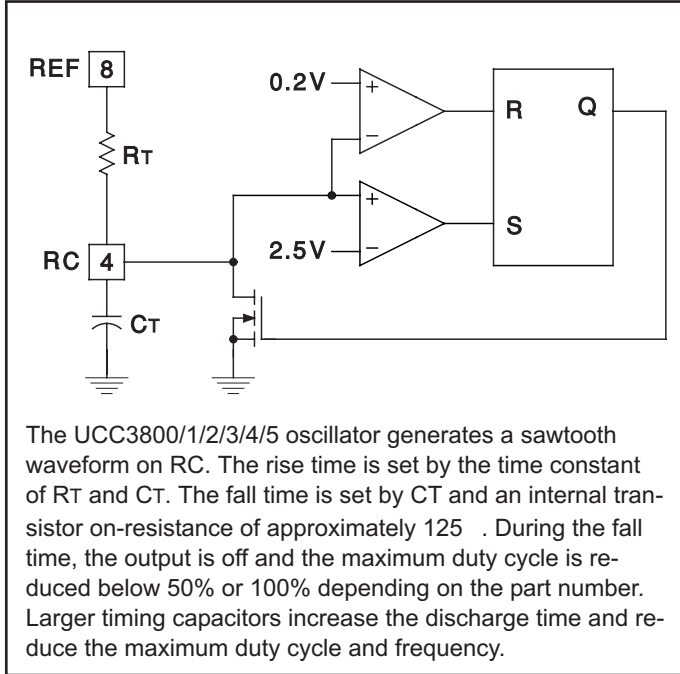

Figure 1. Oscillator.

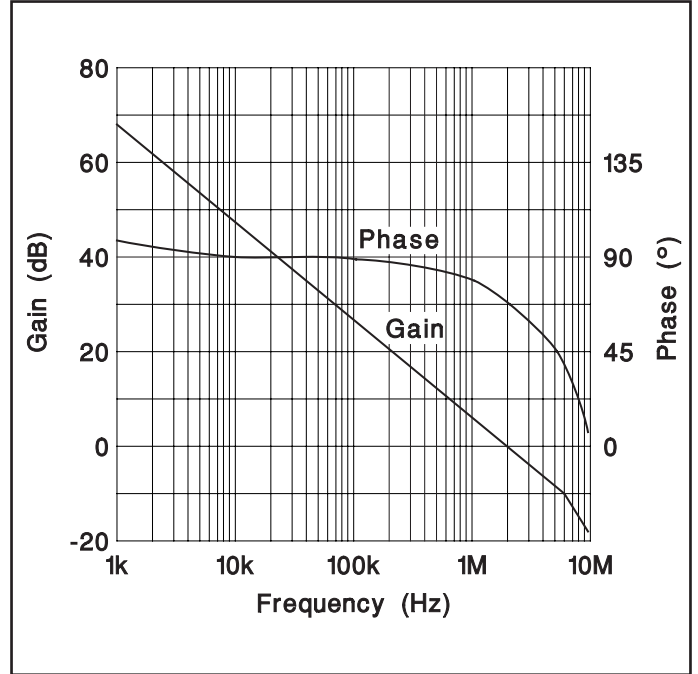

Figure 2. Error amplifier gain/phase response.

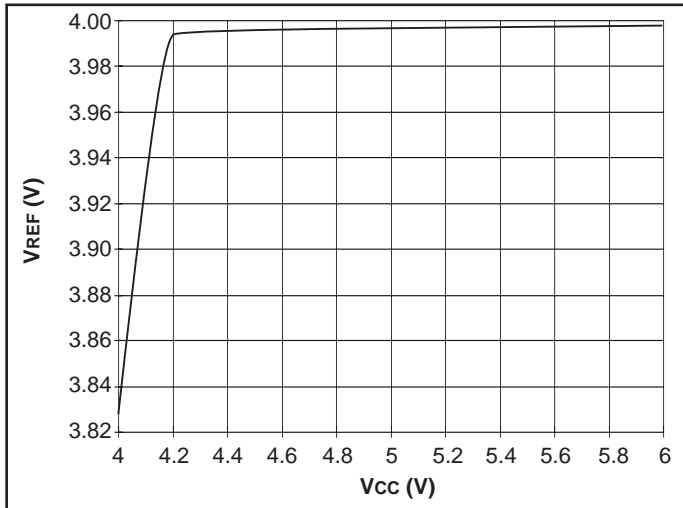

Figure 3. UCC1803/5 V_{REF} vs. V_{CC} ; $I_{LOAD} = 0.5mA$.

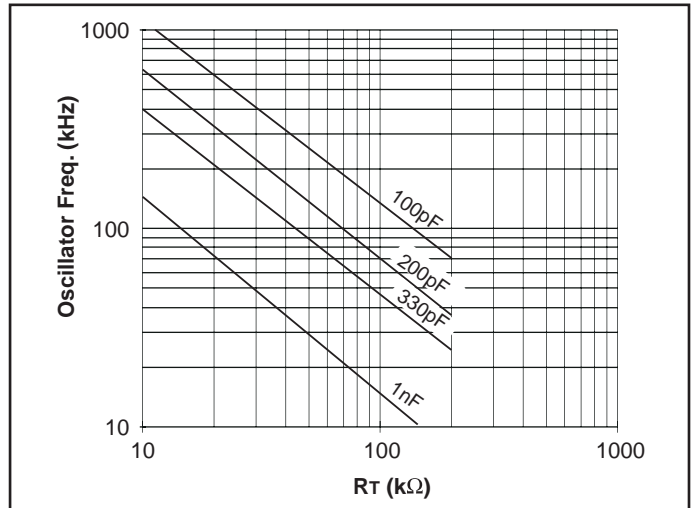

Figure 4. UCC1800/1/2/4 oscillator frequency vs. R_T and C_T .

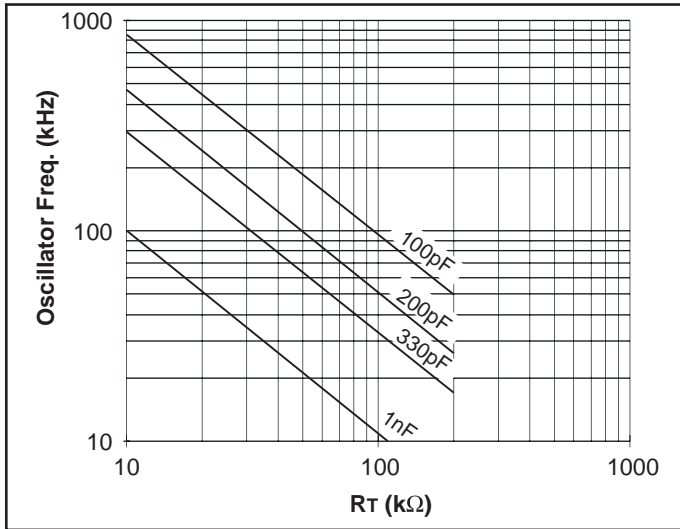

Figure 5. UCC1803/5 oscillator frequency vs. R_T and C_T .

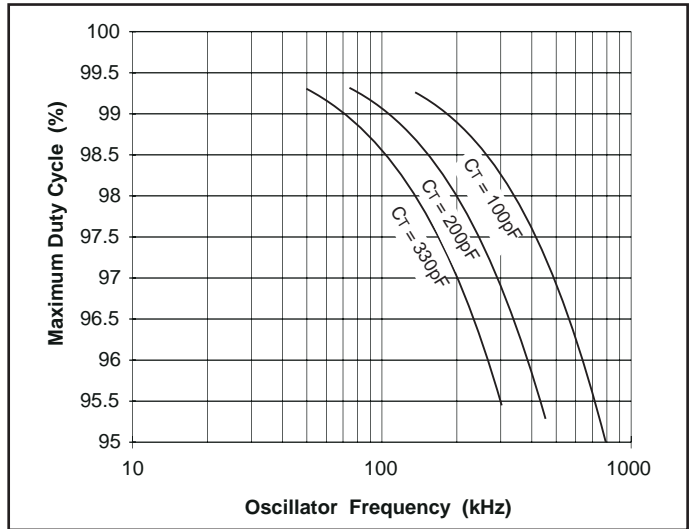

Figure 6. UCC1800/2/3 maximum duty cycle vs. oscillator frequency.

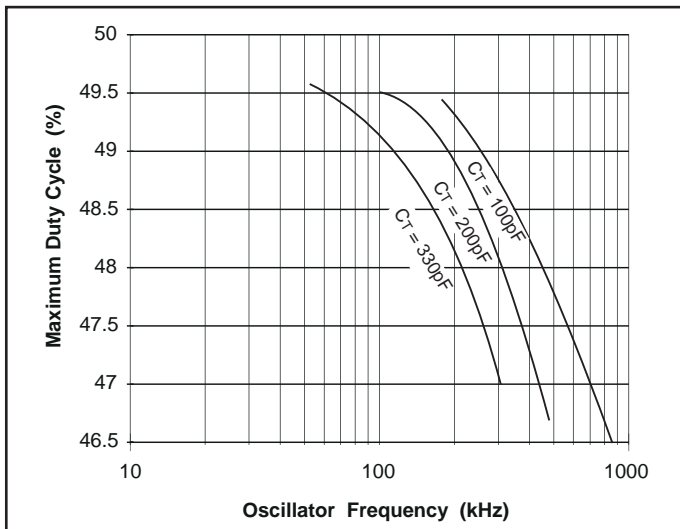

Figure 7. UCC1801/4/5 maximum duty cycle vs. oscillator frequency.

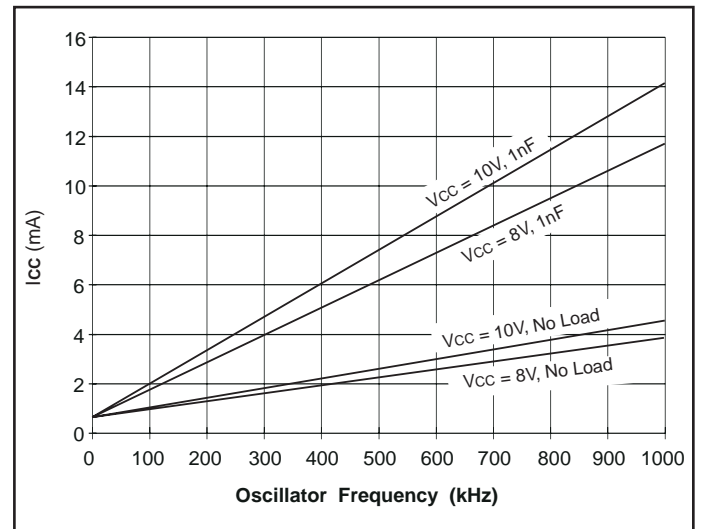

Figure 8. UCC1800 I_{CC} vs. oscillator frequency.

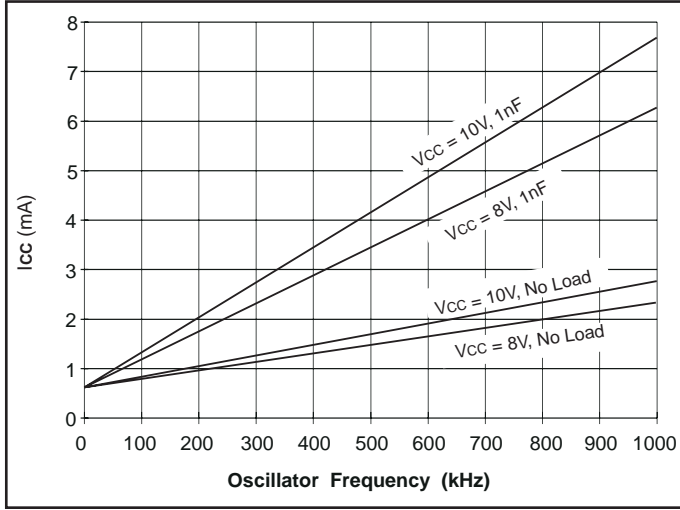

Figure 8. UCC1805 ICC vs. oscillator frequency.

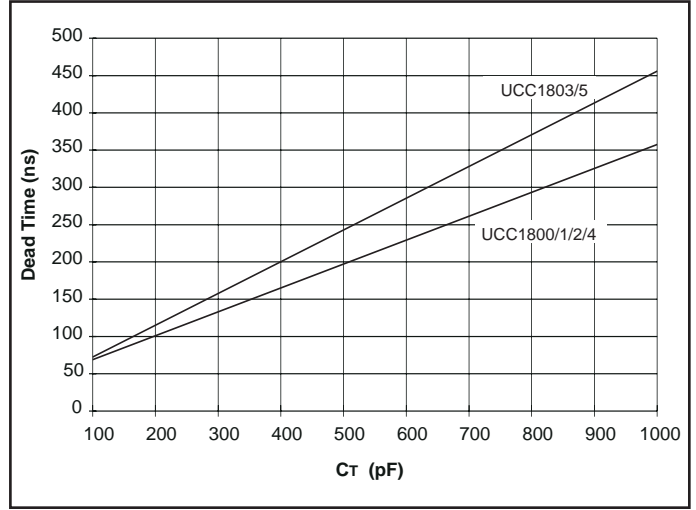

Figure 9. Dead time vs. C_T , $R_T = 100k$.

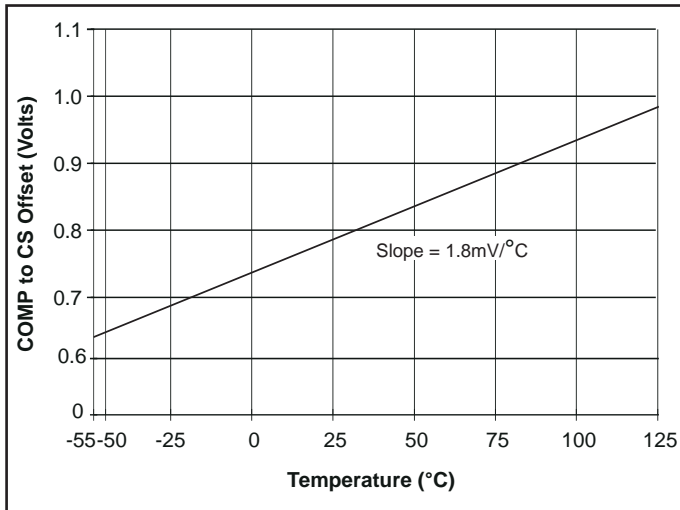

Figure 10. COMP to CS offset vs. temperature, CS = 0V.

PACKAGING INFORMATION

Orderable Device	Status ⁽¹⁾	Package Type	Package Drawing	Pins	Package Qty	Eco Plan ⁽²⁾	Lead/Ball Finish	MSL Peak Temp ⁽³⁾
5962-9451301MPA	ACTIVE	CDIP	JG	8	1	TBD	A42 SNPB	N / A for Pkg Type
5962-9451302MPA	ACTIVE	CDIP	JG	8	1	TBD	A42 SNPB	N / A for Pkg Type
5962-9451303MPA	ACTIVE	CDIP	JG	8	1	TBD	A42 SNPB	N / A for Pkg Type
5962-9451304MPA	ACTIVE	CDIP	JG	8	1	TBD	A42 SNPB	N / A for Pkg Type
5962-9451305MPA	ACTIVE	CDIP	JG	8	1	TBD	A42 SNPB	N / A for Pkg Type
5962-9451305VPA	ACTIVE	CDIP	JG	8	1	TBD	A42	N / A for Pkg Type
UCC1800J	ACTIVE	CDIP	JG	8	1	TBD	A42 SNPB	N / A for Pkg Type
UCC1800J883B	ACTIVE	CDIP	JG	8	1	TBD	A42 SNPB	N / A for Pkg Type
UCC1800L883B	ACTIVE	LCCC	FK	20	1	TBD	POST-PLATE	N / A for Pkg Type
UCC1801J	ACTIVE	CDIP	JG	8	1	TBD	A42 SNPB	N / A for Pkg Type
UCC1801J883B	ACTIVE	CDIP	JG	8	1	TBD	A42 SNPB	N / A for Pkg Type
UCC1802J	ACTIVE	CDIP	JG	8	1	TBD	A42 SNPB	N / A for Pkg Type
UCC1802J883B	ACTIVE	CDIP	JG	8	1	TBD	A42 SNPB	N / A for Pkg Type
UCC1803J	ACTIVE	CDIP	JG	8	1	TBD	A42 SNPB	N / A for Pkg Type
UCC1803J883B	ACTIVE	CDIP	JG	8	1	TBD	A42 SNPB	N / A for Pkg Type
UCC1804J	ACTIVE	CDIP	JG	8	1	TBD	A42 SNPB	N / A for Pkg Type
UCC1804J883B	ACTIVE	CDIP	JG	8	1	TBD	A42 SNPB	N / A for Pkg Type
UCC1805J	ACTIVE	CDIP	JG	8	1	TBD	A42 SNPB	N / A for Pkg Type
UCC1805J883B	ACTIVE	CDIP	JG	8	1	TBD	A42 SNPB	N / A for Pkg Type
UCC2800D	ACTIVE	SOIC	D	8	75	Green (RoHS & no Sb/Br)	CU NIPDAU	Level-1-260C-UNLIM
UCC2800DG4	ACTIVE	SOIC	D	8	75	Green (RoHS & no Sb/Br)	CU NIPDAU	Level-1-260C-UNLIM
UCC2800DTR	ACTIVE	SOIC	D	8	2500	Green (RoHS & no Sb/Br)	CU NIPDAU	Level-1-260C-UNLIM
UCC2800DTRG4	ACTIVE	SOIC	D	8	2500	Green (RoHS & no Sb/Br)	CU NIPDAU	Level-1-260C-UNLIM
UCC2800N	ACTIVE	PDIP	P	8	50	Green (RoHS & no Sb/Br)	CU NIPDAU	N / A for Pkg Type
UCC2800NG4	ACTIVE	PDIP	P	8	50	Green (RoHS & no Sb/Br)	CU NIPDAU	N / A for Pkg Type
UCC2800PW	ACTIVE	TSSOP	PW	8	150	Green (RoHS & no Sb/Br)	CU NIPDAU	Level-2-260C-1 YEAR
UCC2800PWG4	ACTIVE	TSSOP	PW	8	150	Green (RoHS & no Sb/Br)	CU NIPDAU	Level-2-260C-1 YEAR
UCC2801D	ACTIVE	SOIC	D	8	75	Green (RoHS & no Sb/Br)	CU NIPDAU	Level-1-260C-UNLIM
UCC2801DG4	ACTIVE	SOIC	D	8	75	Green (RoHS & no Sb/Br)	CU NIPDAU	Level-1-260C-UNLIM
UCC2801DTR	ACTIVE	SOIC	D	8	2500	Green (RoHS & no Sb/Br)	CU NIPDAU	Level-1-260C-UNLIM
UCC2801DTRG4	ACTIVE	SOIC	D	8	2500	Green (RoHS & no Sb/Br)	CU NIPDAU	Level-1-260C-UNLIM
UCC2801N	ACTIVE	PDIP	P	8	50	Green (RoHS & no Sb/Br)	CU NIPDAU	N / A for Pkg Type
UCC2801NG4	ACTIVE	PDIP	P	8	50	Green (RoHS & no Sb/Br)	CU NIPDAU	N / A for Pkg Type

Orderable Device	Status ⁽¹⁾	Package Type	Package Drawing	Pins	Package Qty	Eco Plan ⁽²⁾	Lead/Ball Finish	MSL Peak Temp ⁽³⁾
						no Sb/Br)		
UCC2801PW	ACTIVE	TSSOP	PW	8	150	Green (RoHS & no Sb/Br)	CU NIPDAU	Level-2-260C-1 YEAR
UCC2801PWG4	ACTIVE	TSSOP	PW	8	150	Green (RoHS & no Sb/Br)	CU NIPDAU	Level-2-260C-1 YEAR
UCC2801QDRQ1G4	ACTIVE	SOIC	D	8		Green (RoHS & no Sb/Br)	CU NIPDAU	Level-1-260C-UNLIM
UCC2802D	ACTIVE	SOIC	D	8	75	Green (RoHS & no Sb/Br)	CU NIPDAU	Level-1-260C-UNLIM
UCC2802DG4	ACTIVE	SOIC	D	8	75	Green (RoHS & no Sb/Br)	CU NIPDAU	Level-1-260C-UNLIM
UCC2802DTR	ACTIVE	SOIC	D	8	2500	Green (RoHS & no Sb/Br)	CU NIPDAU	Level-1-260C-UNLIM
UCC2802DTRG4	ACTIVE	SOIC	D	8	2500	Green (RoHS & no Sb/Br)	CU NIPDAU	Level-1-260C-UNLIM
UCC2802J	ACTIVE	CDIP	JG	8	1	TBD	A42 SNPB	N / A for Pkg Type
UCC2802N	ACTIVE	PDIP	P	8	50	Green (RoHS & no Sb/Br)	CU NIPDAU	N / A for Pkg Type
UCC2802NG4	ACTIVE	PDIP	P	8	50	Green (RoHS & no Sb/Br)	CU NIPDAU	N / A for Pkg Type
UCC2802PW	ACTIVE	TSSOP	PW	8	150	Green (RoHS & no Sb/Br)	CU NIPDAU	Level-2-260C-1 YEAR
UCC2802PWG4	ACTIVE	TSSOP	PW	8	150	Green (RoHS & no Sb/Br)	CU NIPDAU	Level-2-260C-1 YEAR
UCC2803D	ACTIVE	SOIC	D	8	75	Green (RoHS & no Sb/Br)	CU NIPDAU	Level-1-260C-UNLIM
UCC2803DG4	ACTIVE	SOIC	D	8	75	Green (RoHS & no Sb/Br)	CU NIPDAU	Level-1-260C-UNLIM
UCC2803DTR	ACTIVE	SOIC	D	8	2500	Green (RoHS & no Sb/Br)	CU NIPDAU	Level-1-260C-UNLIM
UCC2803DTRG4	ACTIVE	SOIC	D	8	2500	Green (RoHS & no Sb/Br)	CU NIPDAU	Level-1-260C-UNLIM
UCC2803J	ACTIVE	CDIP	JG	8	1	TBD	A42 SNPB	N / A for Pkg Type
UCC2803N	ACTIVE	PDIP	P	8	50	Green (RoHS & no Sb/Br)	CU NIPDAU	N / A for Pkg Type
UCC2803NG4	ACTIVE	PDIP	P	8	50	Green (RoHS & no Sb/Br)	CU NIPDAU	N / A for Pkg Type
UCC2803PW	ACTIVE	TSSOP	PW	8	150	Green (RoHS & no Sb/Br)	CU NIPDAU	Level-2-260C-1 YEAR
UCC2803PWG4	ACTIVE	TSSOP	PW	8	150	Green (RoHS & no Sb/Br)	CU NIPDAU	Level-2-260C-1 YEAR
UCC2803PWTR	ACTIVE	TSSOP	PW	8	2000	Green (RoHS & no Sb/Br)	CU NIPDAU	Level-2-260C-1 YEAR
UCC2803PWTRG4	ACTIVE	TSSOP	PW	8	2000	Green (RoHS & no Sb/Br)	CU NIPDAU	Level-2-260C-1 YEAR
UCC2804D	ACTIVE	SOIC	D	8	75	Green (RoHS & no Sb/Br)	CU NIPDAU	Level-1-260C-UNLIM
UCC2804D/70021	OBSOLETE	SOIC	D	8		TBD	Call TI	Call TI
UCC2804DG4	ACTIVE	SOIC	D	8	75	Green (RoHS & no Sb/Br)	CU NIPDAU	Level-1-260C-UNLIM
UCC2804DR81221G4	ACTIVE	SOIC	D	8		TBD	Call TI	Call TI

Orderable Device	Status ⁽¹⁾	Package Type	Package Drawing	Pins	Package Qty	Eco Plan ⁽²⁾	Lead/Ball Finish	MSL Peak Temp ⁽³⁾
UCC2804DTR	ACTIVE	SOIC	D	8	2500	Green (RoHS & no Sb/Br)	CU NIPDAU	Level-1-260C-UNLIM
UCC2804DTR/81221	ACTIVE	SOIC	D	8		TBD	Call TI	Call TI
UCC2804DTRG4	ACTIVE	SOIC	D	8	2500	Green (RoHS & no Sb/Br)	CU NIPDAU	Level-1-260C-UNLIM
UCC2804N	ACTIVE	PDIP	P	8	50	Green (RoHS & no Sb/Br)	CU NIPDAU	N / A for Pkg Type
UCC2804NG4	ACTIVE	PDIP	P	8	50	Green (RoHS & no Sb/Br)	CU NIPDAU	N / A for Pkg Type
UCC2804PW	ACTIVE	TSSOP	PW	8	150	Green (RoHS & no Sb/Br)	CU NIPDAU	Level-2-260C-1 YEAR
UCC2804PWG4	ACTIVE	TSSOP	PW	8	150	Green (RoHS & no Sb/Br)	CU NIPDAU	Level-2-260C-1 YEAR
UCC2804PWTR	ACTIVE	TSSOP	PW	8	2000	Green (RoHS & no Sb/Br)	CU NIPDAU	Level-2-260C-1 YEAR
UCC2804PWTRG4	ACTIVE	TSSOP	PW	8	2000	Green (RoHS & no Sb/Br)	CU NIPDAU	Level-2-260C-1 YEAR
UCC2805D	ACTIVE	SOIC	D	8	75	Green (RoHS & no Sb/Br)	CU NIPDAU	Level-1-260C-UNLIM
UCC2805DG4	ACTIVE	SOIC	D	8	75	Green (RoHS & no Sb/Br)	CU NIPDAU	Level-1-260C-UNLIM
UCC2805DTR	ACTIVE	SOIC	D	8	2500	Green (RoHS & no Sb/Br)	CU NIPDAU	Level-1-260C-UNLIM
UCC2805DTRG4	ACTIVE	SOIC	D	8	2500	Green (RoHS & no Sb/Br)	CU NIPDAU	Level-1-260C-UNLIM
UCC2805N	ACTIVE	PDIP	P	8	50	Green (RoHS & no Sb/Br)	CU NIPDAU	N / A for Pkg Type
UCC2805NG4	ACTIVE	PDIP	P	8	50	Green (RoHS & no Sb/Br)	CU NIPDAU	N / A for Pkg Type
UCC2805PW	ACTIVE	TSSOP	PW	8	150	Green (RoHS & no Sb/Br)	CU NIPDAU	Level-2-260C-1 YEAR
UCC2805PWG4	ACTIVE	TSSOP	PW	8	150	Green (RoHS & no Sb/Br)	CU NIPDAU	Level-2-260C-1 YEAR
UCC3800D	ACTIVE	SOIC	D	8	75	Green (RoHS & no Sb/Br)	CU NIPDAU	Level-1-260C-UNLIM
UCC3800DG4	ACTIVE	SOIC	D	8	75	Green (RoHS & no Sb/Br)	CU NIPDAU	Level-1-260C-UNLIM
UCC3800DTR	ACTIVE	SOIC	D	8	2500	Green (RoHS & no Sb/Br)	CU NIPDAU	Level-1-260C-UNLIM
UCC3800DTRG4	ACTIVE	SOIC	D	8	2500	Green (RoHS & no Sb/Br)	CU NIPDAU	Level-1-260C-UNLIM
UCC3800N	ACTIVE	PDIP	P	8	50	Green (RoHS & no Sb/Br)	CU NIPDAU	N / A for Pkg Type
UCC3800NG4	ACTIVE	PDIP	P	8	50	Green (RoHS & no Sb/Br)	CU NIPDAU	N / A for Pkg Type
UCC3800PW	ACTIVE	TSSOP	PW	8	150	Green (RoHS & no Sb/Br)	CU NIPDAU	Level-2-260C-1 YEAR
UCC3800PWG4	ACTIVE	TSSOP	PW	8	150	Green (RoHS & no Sb/Br)	CU NIPDAU	Level-2-260C-1 YEAR
UCC3801D	ACTIVE	SOIC	D	8	75	Green (RoHS & no Sb/Br)	CU NIPDAU	Level-1-260C-UNLIM

Orderable Device	Status ⁽¹⁾	Package Type	Package Drawing	Pins	Package Qty	Eco Plan ⁽²⁾	Lead/Ball Finish	MSL Peak Temp ⁽³⁾
UCC3801DG4	ACTIVE	SOIC	D	8	75	Green (RoHS & no Sb/Br)	CU NIPDAU	Level-1-260C-UNLIM
UCC3801DTR	ACTIVE	SOIC	D	8	2500	Green (RoHS & no Sb/Br)	CU NIPDAU	Level-1-260C-UNLIM
UCC3801DTRG4	ACTIVE	SOIC	D	8	2500	Green (RoHS & no Sb/Br)	CU NIPDAU	Level-1-260C-UNLIM
UCC3801N	ACTIVE	PDIP	P	8	50	Green (RoHS & no Sb/Br)	CU NIPDAU	N / A for Pkg Type
UCC3801NG4	ACTIVE	PDIP	P	8	50	Green (RoHS & no Sb/Br)	CU NIPDAU	N / A for Pkg Type
UCC3801PW	ACTIVE	TSSOP	PW	8	150	Green (RoHS & no Sb/Br)	Call TI	Level-2-260C-1 YEAR
UCC3801PWG4	ACTIVE	TSSOP	PW	8	150	Green (RoHS & no Sb/Br)	Call TI	Level-2-260C-1 YEAR
UCC3801PWTR	ACTIVE	TSSOP	PW	8	2000	Green (RoHS & no Sb/Br)	CU NIPDAU	Level-2-260C-1 YEAR
UCC3801PWTRG4	ACTIVE	TSSOP	PW	8	2000	Green (RoHS & no Sb/Br)	CU NIPDAU	Level-2-260C-1 YEAR
UCC3802D	ACTIVE	SOIC	D	8	75	Green (RoHS & no Sb/Br)	CU NIPDAU	Level-1-260C-UNLIM
UCC3802DG4	ACTIVE	SOIC	D	8	75	Green (RoHS & no Sb/Br)	CU NIPDAU	Level-1-260C-UNLIM
UCC3802DTR	ACTIVE	SOIC	D	8	2500	Green (RoHS & no Sb/Br)	CU NIPDAU	Level-1-260C-UNLIM
UCC3802DTRG4	ACTIVE	SOIC	D	8	2500	Green (RoHS & no Sb/Br)	CU NIPDAU	Level-1-260C-UNLIM
UCC3802N	ACTIVE	PDIP	P	8	50	Green (RoHS & no Sb/Br)	CU NIPDAU	N / A for Pkg Type
UCC3802NG4	ACTIVE	PDIP	P	8	50	Green (RoHS & no Sb/Br)	CU NIPDAU	N / A for Pkg Type
UCC3802PW	ACTIVE	TSSOP	PW	8	150	Green (RoHS & no Sb/Br)	CU NIPDAU	Level-2-260C-1 YEAR
UCC3802PWG4	ACTIVE	TSSOP	PW	8	150	Green (RoHS & no Sb/Br)	CU NIPDAU	Level-2-260C-1 YEAR
UCC3803D	ACTIVE	SOIC	D	8	75	Green (RoHS & no Sb/Br)	CU NIPDAU	Level-1-260C-UNLIM
UCC3803DG4	ACTIVE	SOIC	D	8	75	Green (RoHS & no Sb/Br)	CU NIPDAU	Level-1-260C-UNLIM
UCC3803DTR	ACTIVE	SOIC	D	8	2500	Green (RoHS & no Sb/Br)	CU NIPDAU	Level-1-260C-UNLIM
UCC3803DTRG4	ACTIVE	SOIC	D	8	2500	Green (RoHS & no Sb/Br)	CU NIPDAU	Level-1-260C-UNLIM
UCC3803N	ACTIVE	PDIP	P	8	50	Green (RoHS & no Sb/Br)	CU NIPDAU	N / A for Pkg Type
UCC3803NG4	ACTIVE	PDIP	P	8	50	Green (RoHS & no Sb/Br)	CU NIPDAU	N / A for Pkg Type
UCC3803PW	ACTIVE	TSSOP	PW	8	150	Green (RoHS & no Sb/Br)	CU NIPDAU	Level-2-260C-1 YEAR
UCC3803PWG4	ACTIVE	TSSOP	PW	8	150	Green (RoHS & no Sb/Br)	CU NIPDAU	Level-2-260C-1 YEAR
UCC3803PWTR	ACTIVE	TSSOP	PW	8	2000	Green (RoHS & no Sb/Br)	CU NIPDAU	Level-2-260C-1 YEAR

Orderable Device	Status ⁽¹⁾	Package Type	Package Drawing	Pins	Package Qty	Eco Plan ⁽²⁾	Lead/Ball Finish	MSL Peak Temp ⁽³⁾
UCC3803PWTRG4	ACTIVE	TSSOP	PW	8	2000	Green (RoHS & no Sb/Br)	CU NIPDAU	Level-2-260C-1 YEAR
UCC3804D	ACTIVE	SOIC	D	8	75	Green (RoHS & no Sb/Br)	CU NIPDAU	Level-1-260C-UNLIM
UCC3804DG4	ACTIVE	SOIC	D	8	75	Green (RoHS & no Sb/Br)	CU NIPDAU	Level-1-260C-UNLIM
UCC3804DTR	ACTIVE	SOIC	D	8	2500	Green (RoHS & no Sb/Br)	CU NIPDAU	Level-1-260C-UNLIM
UCC3804DTRG4	ACTIVE	SOIC	D	8	2500	Green (RoHS & no Sb/Br)	CU NIPDAU	Level-1-260C-UNLIM
UCC3804N	ACTIVE	PDIP	P	8	50	Green (RoHS & no Sb/Br)	CU NIPDAU	N / A for Pkg Type
UCC3804NG4	ACTIVE	PDIP	P	8	50	Green (RoHS & no Sb/Br)	CU NIPDAU	N / A for Pkg Type
UCC3804PW	ACTIVE	TSSOP	PW	8	150	Green (RoHS & no Sb/Br)	CU NIPDAU	Level-2-260C-1 YEAR
UCC3804PWG4	ACTIVE	TSSOP	PW	8	150	Green (RoHS & no Sb/Br)	CU NIPDAU	Level-2-260C-1 YEAR
UCC3804PWTR	ACTIVE	TSSOP	PW	8	2000	Green (RoHS & no Sb/Br)	CU NIPDAU	Level-2-260C-1 YEAR
UCC3804PWTRG4	ACTIVE	TSSOP	PW	8	2000	Green (RoHS & no Sb/Br)	CU NIPDAU	Level-2-260C-1 YEAR
UCC3805D	ACTIVE	SOIC	D	8	75	Green (RoHS & no Sb/Br)	CU NIPDAU	Level-1-260C-UNLIM
UCC3805DG4	ACTIVE	SOIC	D	8	75	Green (RoHS & no Sb/Br)	CU NIPDAU	Level-1-260C-UNLIM
UCC3805DTR	ACTIVE	SOIC	D	8	2500	Green (RoHS & no Sb/Br)	CU NIPDAU	Level-1-260C-UNLIM
UCC3805DTR/81222G4	PREVIEW	SOIC	D	8		Green (RoHS & no Sb/Br)	CU NIPDAU	Level-1-260C-UNLIM
UCC3805DTRG4	ACTIVE	SOIC	D	8	2500	Green (RoHS & no Sb/Br)	CU NIPDAU	Level-1-260C-UNLIM
UCC3805N	ACTIVE	PDIP	P	8	50	Green (RoHS & no Sb/Br)	CU NIPDAU	N / A for Pkg Type
UCC3805NG4	ACTIVE	PDIP	P	8	50	Green (RoHS & no Sb/Br)	CU NIPDAU	N / A for Pkg Type
UCC3805PW	ACTIVE	TSSOP	PW	8	150	Green (RoHS & no Sb/Br)	CU NIPDAU	Level-2-260C-1 YEAR
UCC3805PWG4	ACTIVE	TSSOP	PW	8	150	Green (RoHS & no Sb/Br)	CU NIPDAU	Level-2-260C-1 YEAR

⁽¹⁾ The marketing status values are defined as follows:

ACTIVE: Product device recommended for new designs.

LIFEBUY: TI has announced that the device will be discontinued, and a lifetime-buy period is in effect.

NRND: Not recommended for new designs. Device is in production to support existing customers, but TI does not recommend using this part in a new design.

PREVIEW: Device has been announced but is not in production. Samples may or may not be available.

OBSOLETE: TI has discontinued the production of the device.

⁽²⁾ Eco Plan - The planned eco-friendly classification: Pb-Free (RoHS), Pb-Free (RoHS Exempt), or Green (RoHS & no Sb/Br) - please check <http://www.ti.com/productcontent> for the latest availability information and additional product content details.

TBD: The Pb-Free/Green conversion plan has not been defined.

Pb-Free (RoHS): TI's terms "Lead-Free" or "Pb-Free" mean semiconductor products that are compatible with the current RoHS requirements for all 6 substances, including the requirement that lead not exceed 0.1% by weight in homogeneous materials. Where designed to be soldered

at high temperatures, TI Pb-Free products are suitable for use in specified lead-free processes.

Pb-Free (RoHS Exempt): This component has a RoHS exemption for either 1) lead-based flip-chip solder bumps used between the die and package, or 2) lead-based die adhesive used between the die and leadframe. The component is otherwise considered Pb-Free (RoHS compatible) as defined above.

Green (RoHS & no Sb/Br): TI defines "Green" to mean Pb-Free (RoHS compatible), and free of Bromine (Br) and Antimony (Sb) based flame retardants (Br or Sb do not exceed 0.1% by weight in homogeneous material)

⁽³⁾ MSL, Peak Temp. -- The Moisture Sensitivity Level rating according to the JEDEC industry standard classifications, and peak solder temperature.

Important Information and Disclaimer:The information provided on this page represents TI's knowledge and belief as of the date that it is provided. TI bases its knowledge and belief on information provided by third parties, and makes no representation or warranty as to the accuracy of such information. Efforts are underway to better integrate information from third parties. TI has taken and continues to take reasonable steps to provide representative and accurate information but may not have conducted destructive testing or chemical analysis on incoming materials and chemicals. TI and TI suppliers consider certain information to be proprietary, and thus CAS numbers and other limited information may not be available for release.

In no event shall TI's liability arising out of such information exceed the total purchase price of the TI part(s) at issue in this document sold by TI to Customer on an annual basis.

OTHER QUALIFIED VERSIONS OF UCC1800, UCC1801, UCC1802, UCC1803, UCC1804, UCC1805, UCC1805-SP, UCC2800, UCC2801, UCC2802, UCC2802M, UCC2803, UCC2803M, UCC2804, UCC2805, UCC3800, UCC3801, UCC3802, UCC3803, UCC3804, UCC3805 :

- Automotive: [UCC2800-Q1](#), [UCC2801-Q1](#), [UCC2802-Q1](#), [UCC2803-Q1](#), [UCC2804-Q1](#), [UCC2805-Q1](#)
- Enhanced Product: [UCC2800-EP](#), [UCC2801-EP](#), [UCC2802-EP](#), [UCC2803-EP](#), [UCC2804-EP](#), [UCC2805-EP](#)

NOTE: Qualified Version Definitions:

- Automotive - Q100 devices qualified for high-reliability automotive applications targeting zero defects
- Enhanced Product - Supports Defense, Aerospace and Medical Applications

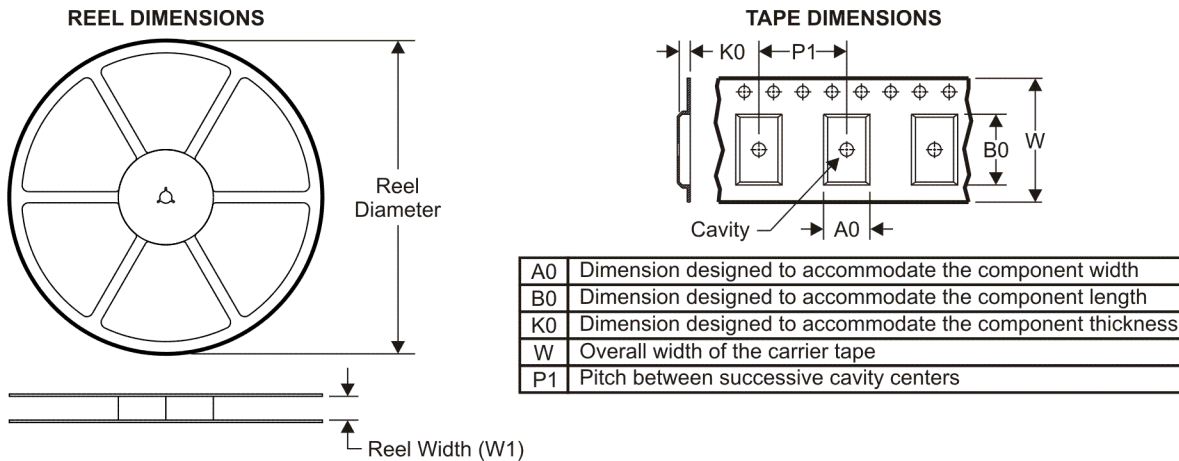
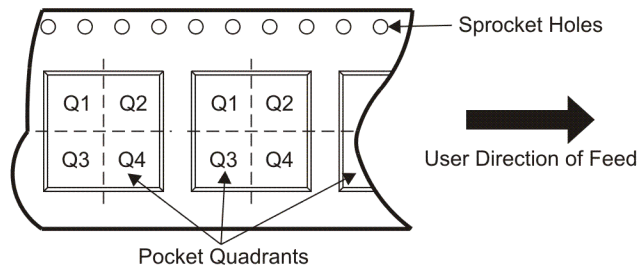
TAPE AND REEL INFORMATION

QUADRANT ASSIGNMENTS FOR PIN 1 ORIENTATION IN TAPE

*All dimensions are nominal

Device	Package Type	Package Drawing	Pins	SPQ	Reel Diameter (mm)	Reel Width W1 (mm)	A0 (mm)	B0 (mm)	K0 (mm)	P1 (mm)	W (mm)	Pin1 Quadrant
UCC2800DTR	SOIC	D	8	2500	330.0	12.4	6.4	5.2	2.1	8.0	12.0	Q1
UCC2801DTR	SOIC	D	8	2500	330.0	12.4	6.4	5.2	2.1	8.0	12.0	Q1
UCC2802DTR	SOIC	D	8	2500	330.0	12.4	6.4	5.2	2.1	8.0	12.0	Q1
UCC2803DTR	SOIC	D	8	2500	330.0	12.4	6.4	5.2	2.1	8.0	12.0	Q1
UCC2803PWTR	TSSOP	PW	8	2000	330.0	12.4	7.0	3.6	1.6	8.0	12.0	Q1
UCC2804DTR	SOIC	D	8	2500	330.0	12.4	6.4	5.2	2.1	8.0	12.0	Q1
UCC2804PWTR	TSSOP	PW	8	2000	330.0	12.4	7.0	3.6	1.6	8.0	12.0	Q1
UCC2805DTR	SOIC	D	8	2500	330.0	12.4	6.4	5.2	2.1	8.0	12.0	Q1
UCC3800DTR	SOIC	D	8	2500	330.0	12.4	6.4	5.2	2.1	8.0	12.0	Q1
UCC3801DTR	SOIC	D	8	2500	330.0	12.4	6.4	5.2	2.1	8.0	12.0	Q1
UCC3801PWTR	TSSOP	PW	8	2000	330.0	12.4	7.0	3.6	1.6	8.0	12.0	Q1
UCC3802DTR	SOIC	D	8	2500	330.0	12.4	6.4	5.2	2.1	8.0	12.0	Q1
UCC3803DTR	SOIC	D	8	2500	330.0	12.4	6.4	5.2	2.1	8.0	12.0	Q1
UCC3803PWTR	TSSOP	PW	8	2000	330.0	12.4	7.0	3.6	1.6	8.0	12.0	Q1
UCC3804DTR	SOIC	D	8	2500	330.0	12.4	6.4	5.2	2.1	8.0	12.0	Q1
UCC3804PWTR	TSSOP	PW	8	2000	330.0	12.4	7.0	3.6	1.6	8.0	12.0	Q1
UCC3805DTR	SOIC	D	8	2500	330.0	12.4	6.4	5.2	2.1	8.0	12.0	Q1

TAPE AND REEL BOX DIMENSIONS

*All dimensions are nominal

Device	Package Type	Package Drawing	Pins	SPQ	Length (mm)	Width (mm)	Height (mm)
UCC2800DTR	SOIC	D	8	2500	340.5	338.1	20.6
UCC2801DTR	SOIC	D	8	2500	340.5	338.1	20.6
UCC2802DTR	SOIC	D	8	2500	340.5	338.1	20.6
UCC2803DTR	SOIC	D	8	2500	340.5	338.1	20.6
UCC2803PWTR	TSSOP	PW	8	2000	346.0	346.0	29.0
UCC2804DTR	SOIC	D	8	2500	340.5	338.1	20.6
UCC2804PWTR	TSSOP	PW	8	2000	346.0	346.0	29.0
UCC2805DTR	SOIC	D	8	2500	340.5	338.1	20.6
UCC3800DTR	SOIC	D	8	2500	340.5	338.1	20.6
UCC3801DTR	SOIC	D	8	2500	340.5	338.1	20.6
UCC3801PWTR	TSSOP	PW	8	2000	346.0	346.0	29.0
UCC3802DTR	SOIC	D	8	2500	340.5	338.1	20.6
UCC3803DTR	SOIC	D	8	2500	340.5	338.1	20.6
UCC3803PWTR	TSSOP	PW	8	2000	346.0	346.0	29.0
UCC3804DTR	SOIC	D	8	2500	340.5	338.1	20.6
UCC3804PWTR	TSSOP	PW	8	2000	346.0	346.0	29.0
UCC3805DTR	SOIC	D	8	2500	340.5	338.1	20.6

PW (R-PDSO-G**)

PLASTIC SMALL-OUTLINE PACKAGE

14 PINS SHOWN



4040064/F 01/97

- NOTES: A. All linear dimensions are in millimeters.
 B. This drawing is subject to change without notice.
 C. Body dimensions do not include mold flash or protrusion not to exceed 0,15.
 D. Falls within JEDEC MO-153

FK (S-CQCC-N**)

LEADLESS CERAMIC CHIP CARRIER

28 TERMINAL SHOWN

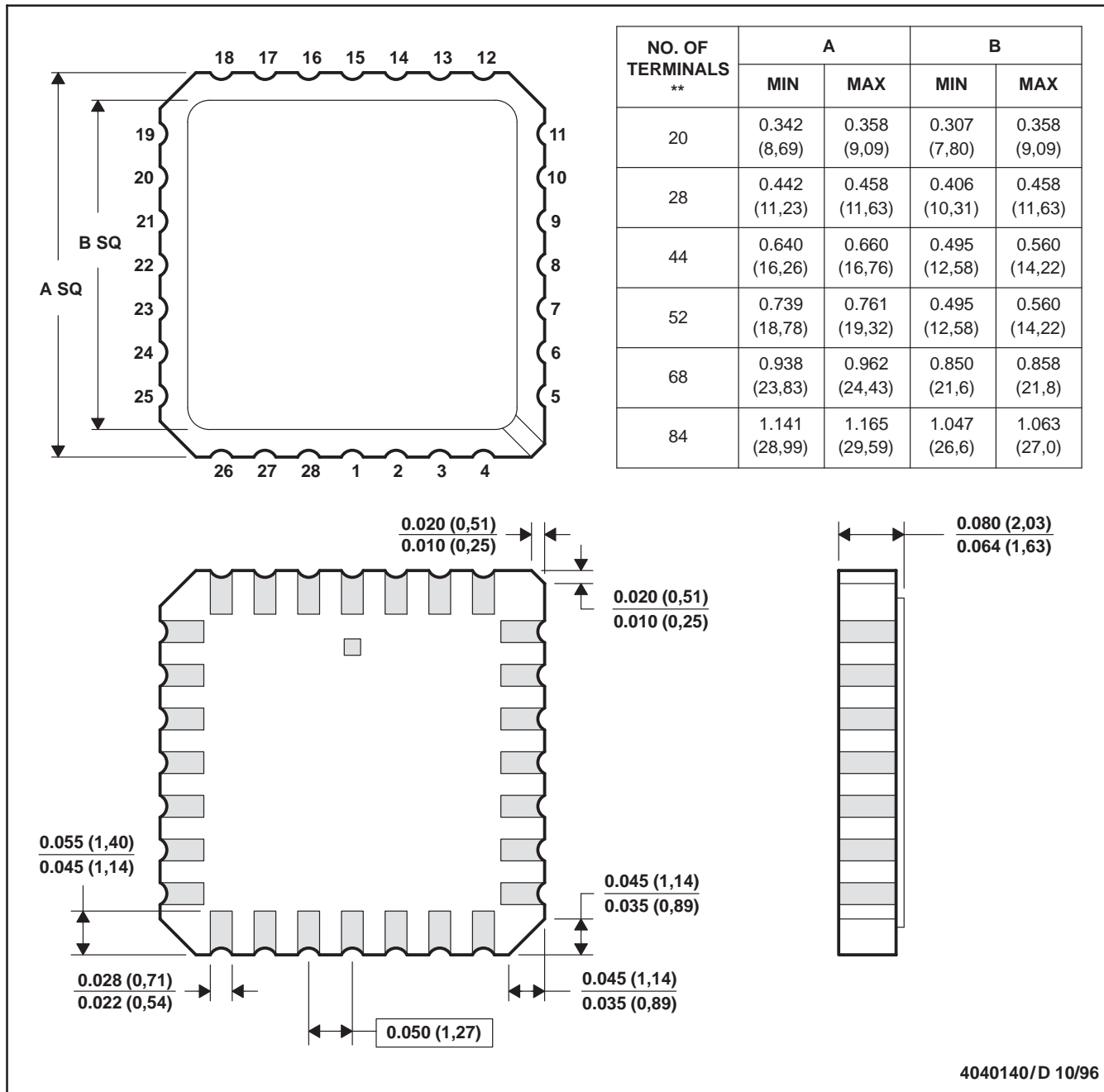

- NOTES:
- A. All linear dimensions are in inches (millimeters).
 - B. This drawing is subject to change without notice.
 - C. This package can be hermetically sealed with a metal lid.
 - D. The terminals are gold plated.
 - E. Falls within JEDEC MS-004

JG (R-GDIP-T8)

CERAMIC DUAL-IN-LINE

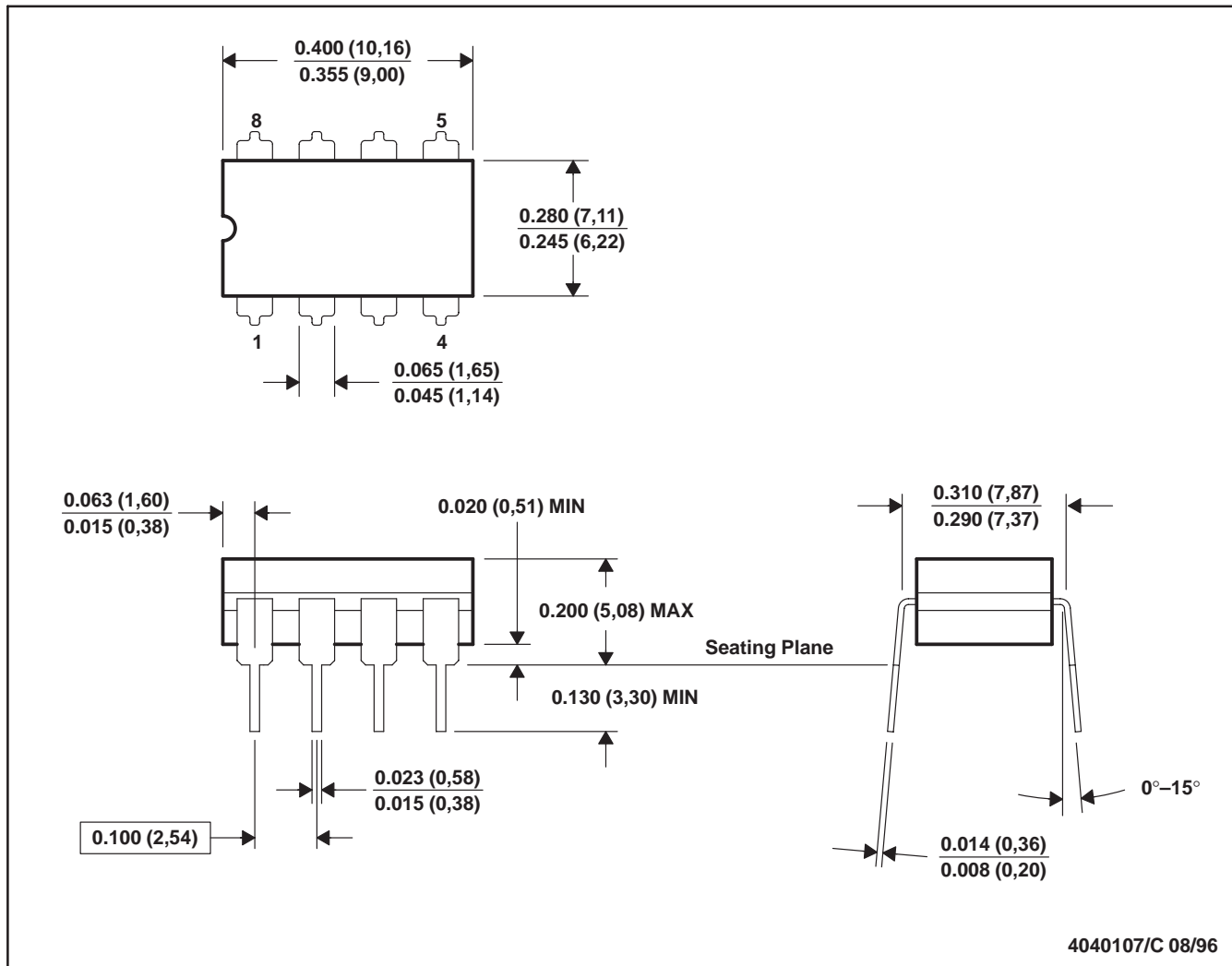

- NOTES: A. All linear dimensions are in inches (millimeters).
 B. This drawing is subject to change without notice.
 C. This package can be hermetically sealed with a ceramic lid using glass frit.
 D. Index point is provided on cap for terminal identification.
 E. Falls within MIL STD 1835 GDIP1-T8

IMPORTANT NOTICE

Texas Instruments Incorporated and its subsidiaries (TI) reserve the right to make corrections, modifications, enhancements, improvements, and other changes to its products and services at any time and to discontinue any product or service without notice. Customers should obtain the latest relevant information before placing orders and should verify that such information is current and complete. All products are sold subject to TI's terms and conditions of sale supplied at the time of order acknowledgment.

TI warrants performance of its hardware products to the specifications applicable at the time of sale in accordance with TI's standard warranty. Testing and other quality control techniques are used to the extent TI deems necessary to support this warranty. Except where mandated by government requirements, testing of all parameters of each product is not necessarily performed.

TI assumes no liability for applications assistance or customer product design. Customers are responsible for their products and applications using TI components. To minimize the risks associated with customer products and applications, customers should provide adequate design and operating safeguards.

TI does not warrant or represent that any license, either express or implied, is granted under any TI patent right, copyright, mask work right, or other TI intellectual property right relating to any combination, machine, or process in which TI products or services are used. Information published by TI regarding third-party products or services does not constitute a license from TI to use such products or services or a warranty or endorsement thereof. Use of such information may require a license from a third party under the patents or other intellectual property of the third party, or a license from TI under the patents or other intellectual property of TI.

Reproduction of TI information in TI data books or data sheets is permissible only if reproduction is without alteration and is accompanied by all associated warranties, conditions, limitations, and notices. Reproduction of this information with alteration is an unfair and deceptive business practice. TI is not responsible or liable for such altered documentation. Information of third parties may be subject to additional restrictions.

Resale of TI products or services with statements different from or beyond the parameters stated by TI for that product or service voids all express and any implied warranties for the associated TI product or service and is an unfair and deceptive business practice. TI is not responsible or liable for any such statements.

TI products are not authorized for use in safety-critical applications (such as life support) where a failure of the TI product would reasonably be expected to cause severe personal injury or death, unless officers of the parties have executed an agreement specifically governing such use. Buyers represent that they have all necessary expertise in the safety and regulatory ramifications of their applications, and acknowledge and agree that they are solely responsible for all legal, regulatory and safety-related requirements concerning their products and any use of TI products in such safety-critical applications, notwithstanding any applications-related information or support that may be provided by TI. Further, Buyers must fully indemnify TI and its representatives against any damages arising out of the use of TI products in such safety-critical applications.

TI products are neither designed nor intended for use in military/aerospace applications or environments unless the TI products are specifically designated by TI as military-grade or "enhanced plastic." Only products designated by TI as military-grade meet military specifications. Buyers acknowledge and agree that any such use of TI products which TI has not designated as military-grade is solely at the Buyer's risk, and that they are solely responsible for compliance with all legal and regulatory requirements in connection with such use.

TI products are neither designed nor intended for use in automotive applications or environments unless the specific TI products are designated by TI as compliant with ISO/TS 16949 requirements. Buyers acknowledge and agree that, if they use any non-designated products in automotive applications, TI will not be responsible for any failure to meet such requirements.

Following are URLs where you can obtain information on other Texas Instruments products and application solutions:

Products

Amplifiers	amplifier.ti.com
Data Converters	dataconverter.ti.com
DLP® Products	www.dlp.com
DSP	dsp.ti.com
Clocks and Timers	www.ti.com/clocks
Interface	interface.ti.com
Logic	logic.ti.com
Power Mgmt	power.ti.com
Microcontrollers	microcontroller.ti.com
RFID	www.ti-rfid.com
RF/IF and ZigBee® Solutions	www.ti.com/lprf

Applications

Audio	www.ti.com/audio
Automotive	www.ti.com/automotive
Broadband	www.ti.com/broadband
Digital Control	www.ti.com/digitalcontrol
Medical	www.ti.com/medical
Military	www.ti.com/military
Optical Networking	www.ti.com/opticalnetwork
Security	www.ti.com/security
Telephony	www.ti.com/telephony
Video & Imaging	www.ti.com/video
Wireless	www.ti.com/wireless

Mailing Address: Texas Instruments, Post Office Box 655303, Dallas, Texas 75265
Copyright © 2009, Texas Instruments Incorporated