

## CDCV304 200-MHz General-Purpose Clock Buffer, PCI-X Compliant

### 1 Features

- General-Purpose and PCI-X 1:4 Clock Buffer
- Operating Frequency
  - 0 MHz to 200 MHz General-Purpose
- Low Output Skew: <100 ps
- Distributes One Clock Input to One Bank of Four Outputs
- Output Enable Control that Drives Outputs Low when OE is Low
- Operates from Single 3.3-V Supply or 2.5-V Supply
- PCI-X Compliant
- 8-Pin TSSOP Package

### 2 Description

The CDCV304 is a high-performance, low-skew, general-purpose PCI-X compliant clock buffer. It distributes one input clock signal (CLKIN) to the output clocks (1Y[0:3]). It is specifically designed for use with PCI-X applications. The CDCV304 operates at 3.3 V and 2.5 V and is therefore compliant to the 3.3-V PCI-X specifications.

The CDCV304 is characterized for operation from –40°C to 85°C for automotive and industrial applications.

#### Device Information<sup>(1)</sup>

PART NUMBER	PACKAGE	BODY SIZE (NOM)
CDCV304	TSSOP (8)	3.00 mm x 4.40 mm

(1) For all available packages, see the orderable addendum at the end of the datasheet.

#### Functional Block Diagram

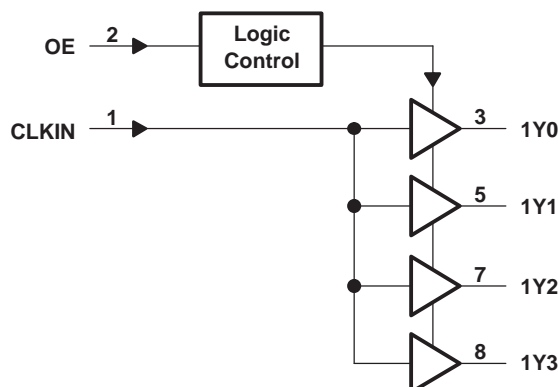

## Table of Contents

<b>1 Features</b> .....	<b>1</b>	5.8 Typical Characteristics .....	<b>6</b>
<b>2 Description</b> .....	<b>1</b>	<b>6 Parameter Measurement Information</b> .....	<b>7</b>
<b>3 Revision History</b> .....	<b>2</b>	<b>7 Detailed Description</b> .....	<b>8</b>
<b>4 Pin Configuration and Functions</b> .....	<b>3</b>	7.1 Functional Block Diagram .....	<b>8</b>
<b>5 Specifications</b> .....	<b>3</b>	7.2 Device Functional Modes .....	<b>8</b>
5.1 Absolute Maximum Ratings .....	<b>3</b>	<b>8 Device and Documentation Support</b> .....	<b>9</b>
5.2 Recommended Operating Conditions .....	<b>4</b>	8.1 Receiving Notification of Documentation Updates .....	<b>9</b>
5.3 Thermal Information .....	<b>4</b>	8.2 Community Resources .....	<b>9</b>
5.4 Electrical Characteristics .....	<b>4</b>	8.3 Trademarks .....	<b>9</b>
5.5 Timing Requirements .....	<b>5</b>	8.4 Electrostatic Discharge Caution .....	<b>9</b>
5.6 Switching Characteristics: $V_{DD} = 2.5\text{ V} \pm 10\%$ .....	<b>5</b>	8.5 Glossary .....	<b>9</b>
5.7 Switching Characteristics: $V_{DD} = 3.3\text{ V} \pm 10\%$ .....	<b>5</b>	<b>9 Mechanical, Packaging, and Orderable Information</b> .....	<b>9</b>

### 3 Revision History

NOTE: Page numbers for previous revisions may differ from page numbers in the current version.

<b>Changes from Revision H (February 2011) to Revision I</b>	<b>Page</b>
• Changed datasheet layout .....	<b>1</b>
• Added Junction temperature, $T_{j, \max} 125\text{ }^{\circ}\text{C}$ .....	<b>3</b>

---

<b>Changes from Revision G (January 2011) to Revision H</b>	<b>Page</b>
• Added missing characteristics graphs .....	<b>6</b>

---

<b>Changes from Revision F (April 2009) to Revision G</b>	<b>Page</b>
• Added $\psi_{JT}$ and $\psi_{JB}$ specs to the Thermal Information Table and changed $R_{\theta JB}$ and $R_{\theta JC}$ specs from 65 and 69 $^{\circ}\text{C}/\text{W}$ respectively .....	<b>4</b>

## 4 Pin Configuration and Functions

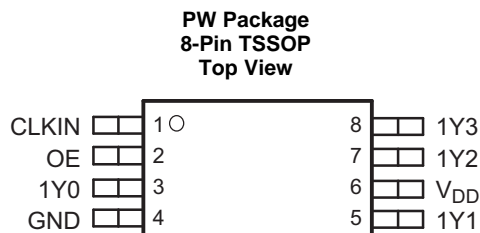

### Pin Functions

PIN		I/O	DESCRIPTION
NAME	NO.		
1Y[0:3]	3, 5, 7, 8	O	Buffered output clocks
CLKIN	1	I	Input reference frequency
GND	4	Power	Ground
OE	2	I	Output enable control
V <sub>DD</sub>	6	Power	Supply

## 5 Specifications

### 5.1 Absolute Maximum Ratings

over operating free-air temperature range (unless otherwise noted) <sup>(1)</sup>

	MIN	MAX	UNIT
Supply voltage range, V <sub>DD</sub>	-0.5	4.3	V
Input voltage range, V <sub>I</sub> <sup>(2) (3)</sup>	-0.5	V <sub>DD</sub> + 0.5	V
Output voltage range, V <sub>O</sub> <sup>(2) (3)</sup>	-0.5	V <sub>DD</sub> + 0.5	V
Input clamp current, I <sub>IK</sub> (V <sub>I</sub> < 0 or V <sub>I</sub> > V <sub>DD</sub> )	-50	50	mA
Output clamp current, I <sub>OK</sub> (V <sub>O</sub> < 0 or V <sub>O</sub> > V <sub>DD</sub> )	-50	50	mA
Continuous total output current, I <sub>O</sub> (V <sub>O</sub> = 0 to V <sub>DD</sub> )	-50	50	mA
Package thermal impedance, $\theta_{JA}$ : PW package		230.5	°C/W
Junction temperature, T <sub>j, max</sub>		125	°C
Storage temperature range T <sub>stg</sub>	-65	150	°C

- (1) Stresses beyond those listed under *Absolute Maximum Ratings* may cause permanent damage to the device. These are stress ratings only, which do not imply functional operation of the device at these or any other conditions beyond those indicated under *Recommended Operating Conditions*. Exposure to absolute-maximum-rated conditions for extended periods may affect device reliability.
- (2) The input and output negative voltage ratings may be exceeded if the input and output clamp-current ratings are observed.
- (3) This value is limited to 4.6 V maximum.

## 5.2 Recommended Operating Conditions

		MIN	NOM	MAX	UNIT
Supply voltage, $V_{DD}$		2.3		3.6	V
Low-level input voltage, $V_{IL}$				$0.3 \times V_{DD}$	V
High-level input voltage, $V_{IH}$		$0.7 \times V_{DD}$			V
Input voltage, $V_I$		0		$V_{DD}$	V
High-level output current, $I_{OH}$	$V_{DD} = 2.5 \text{ V}$			-12	mA
	$V_{DD} = 3.3 \text{ V}$			-24	
Low-level output current, $I_{OL}$	$V_{DD} = 2.5 \text{ V}$			12	mA
	$V_{DD} = 3.3 \text{ V}$			24	
Operating free-air temperature, $T_A$		-40		85	°C

## 5.3 Thermal Information

THERMAL METRIC <sup>(1)</sup>		THERMAL AIR FLOW (CFM)	CDCV304	UNIT	
			PW (TSSOP)		
			8 PINS		
$R_{\theta JA}$	Junction-to-ambient thermal resistance	High K	0	149	°C/W
			150	142	
			250	138	
			500	132	
		Low K		230	
				185	
				170	
				150	
$R_{\theta JC(top)}$	Junction-to-case (top) thermal resistance		43.7		
$R_{\theta JB}$	Junction-to-board thermal resistance		102		
$\psi_{JT}$	Junction-to-top characterization parameter		1.8		
$\psi_{JB}$	Junction-to-board characterization parameter		100.2		

(1) For more information about traditional and new thermal metrics, see the [Semiconductor and IC Package Thermal Metrics](#) application report.

## 5.4 Electrical Characteristics

over recommended operating free-air temperature range (unless otherwise noted)

PARAMETER		TEST CONDITIONS		MIN	TYP <sup>(1)</sup>	MAX	UNIT
$V_{IK}$	Input voltage	$V_{DD} = 3 \text{ V}$ ,	$I_I = -18 \text{ mA}$			-1.2	V
$V_{OH}$	High-level output voltage	$V_{DD} = 2.3 \text{ V}$ ,	$I_{OH} = -8 \text{ mA}$	1.8			V
		$V_{DD} = 2.3 \text{ V}$ ,	$I_{OH} = -16 \text{ mA}$	1.5			
		$V_{DD} = \text{min to max}$ ,	$I_{OH} = -1 \text{ mA}$	$V_{DD} - 0.2$			
		$V_{DD} = 3 \text{ V}$ ,	$I_{OH} = -24 \text{ mA}$	2			
		$V_{DD} = 3 \text{ V}$ ,	$I_{OH} = -12 \text{ mA}$	2.4			
$V_{OL}$	Low-level output voltage	$V_{DD} = 2.3 \text{ V}$ ,	$I_{OL} = 8 \text{ mA}$			0.5	V
		$V_{DD} = 2.3 \text{ V}$ ,	$I_{OL} = 16 \text{ mA}$			0.7	
		$V_{DD} = \text{min to max}$ ,	$I_{OL} = 1 \text{ mA}$			0.2	
		$V_{DD} = 3 \text{ V}$ ,	$I_{OL} = 24 \text{ mA}$			0.8	
		$V_{DD} = 3 \text{ V}$ ,	$I_{OL} = 12 \text{ mA}$			0.55	
$I_{OH}$	High-level output current	$V_{DD} = 3 \text{ V}$ ,	$V_O = 1 \text{ V}$	-50			mA
		$V_{DD} = 3.3 \text{ V}$ ,	$V_O = 1.65 \text{ V}$			-55	
$I_{OL}$	Low-level output current	$V_{DD} = 3 \text{ V}$ ,	$V_O = 2 \text{ V}$	60			mA
		$V_{DD} = 3.3 \text{ V}$ ,	$V_O = 1.65 \text{ V}$			70	

(1) All typical values are with respect to nominal  $V_{DD}$  and  $T_A = 25^\circ\text{C}$ .

## Electrical Characteristics (continued)

over recommended operating free-air temperature range (unless otherwise noted)

PARAMETER		TEST CONDITIONS	MIN	TYP <sup>(1)</sup>	MAX	UNIT
$I_I$	Input current	$V_I = V_O$ or $V_{DD}$			±5	μA
$I_{DD}$	Dynamic current, see <a href="#">Figure 1</a>	$f = 67$ MHz, $V_{DD} = 2.7$ V			28	mA
		$f = 67$ MHz, $V_{DD} = 3.6$ V			37	
$C_I$	Input capacitance	$V_{DD} = 3.3$ V, $V_I = 0$ V or $V_{DD}$		3		pF
$C_O$	Output capacitance	$V_{DD} = 3.3$ V, $V_I = 0$ V or $V_{DD}$		3.2		pF

## 5.5 Timing Requirements

over operating free-air temperature range (unless otherwise noted)

PARAMETER		TEST CONDITIONS	MIN	TYP	MAX	UNIT
$f_{clk}$	Clock frequency		0		200	MHz

## 5.6 Switching Characteristics: $V_{DD} = 2.5$ V ± 10%

$V_{DD} = 2.5$  V ± 10%,  $C_L = 10$  pF (unless otherwise noted)

PARAMETER		TEST CONDITIONS	MIN	TYP <sup>(1)</sup>	MAX	UNIT
$t_{PLH}$	Low-to-high propagation delay	See <a href="#">Figure 4</a> and <a href="#">Figure 5</a>	2	2.9	4.5	ns
$t_{PHL}$	High-to-low propagation delay		2	3	4.5	
$t_{sk(o)}$	Output skew <sup>(2)</sup>	See <a href="#">Figure 6</a>		50	150	ps
$t_r$	Output rise slew rate		1.5	2.2	4	V/ns
$t_f$	Output fall slew rate		1.5	2.2	4	V/ns

(1) All typical values are with respect to nominal  $V_{DD}$ .

(2) The  $t_{sk(o)}$  specification is only valid for equal loading of all outputs.

## 5.7 Switching Characteristics: $V_{DD} = 3.3$ V ± 10%

$V_{DD} = 3.3$  V ± 10%,  $C_L = 10$  pF (unless otherwise noted)

PARAMETER		TEST CONDITIONS	MIN	TYP <sup>(1)</sup>	MAX	UNIT
$t_{PLH}$	Low-to-high propagation delay	See <a href="#">Figure 4</a> and <a href="#">Figure 5</a>	1.8	2.4	3	ns
$t_{PHL}$	High-to-low propagation delay		1.8	2.5	3	
$t_{sk(o)}$	Output skew <sup>(2)</sup>			50	100	ps
$t_{jitter}$	Additive phase jitter from input to output 1Y0	12 kHz to 5 MHz, $f_{out} = 30.72$ MHz		63		fs rms
		12 kHz to 20 MHz, $f_{out} = 125$ MHz		56		
$t_{sk(p)}$	Pulse skew	$V_{IH} = V_{DD}$ , $V_{IL} = 0$ V			150	ps
$t_{sk(pr)}$	Process skew			0.2	0.3	ns
$t_{sk(pp)}$	Part-to-part skew			0.25	0.4	ns
$t_{high}$	Clock high time, see <a href="#">Figure 7</a>	66 MHz	6			ns
		140 MHz	3			
$t_{low}$	Clock low time, see <a href="#">Figure 7</a>	66 MHz	6			ns
		140 MHz	3			
$t_r$	Output rise slew rate <sup>(3)</sup>	$V_O = 0.4$ V to 2 V	1.5	2.7	4	V/ns
$t_f$	Output fall slew rate <sup>(3)</sup>	$V_O = 2$ V to 0.4 V	1.5	2.7	4	V/ns

(1) All typical values are with respect to nominal  $V_{DD}$ .

(2) The  $t_{sk(o)}$  specification is only valid for equal loading of all outputs.

(3) This symbol is according to PCI-X terminology.

### 5.8 Typical Characteristics

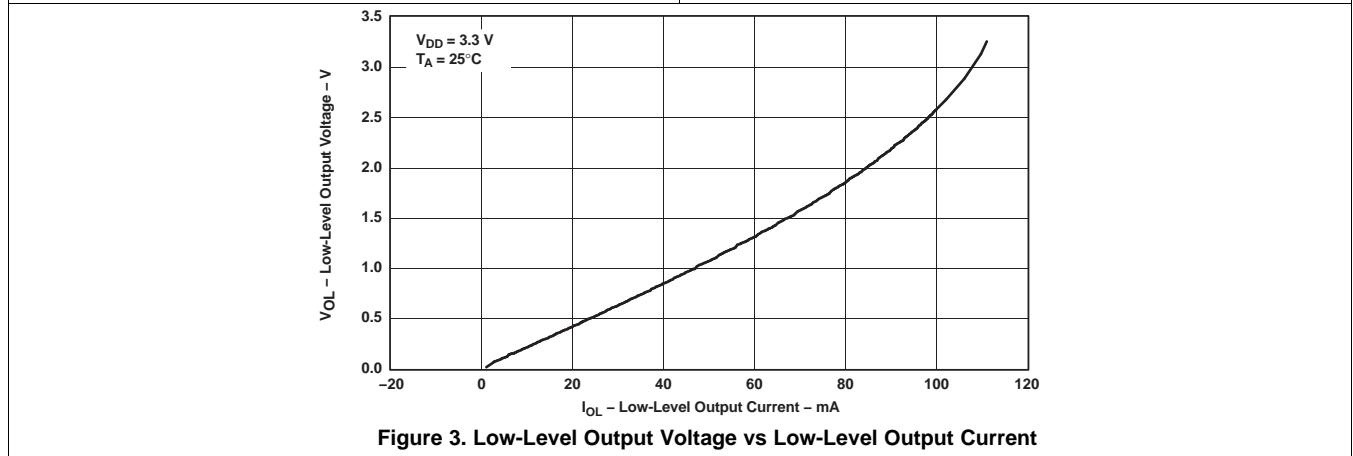
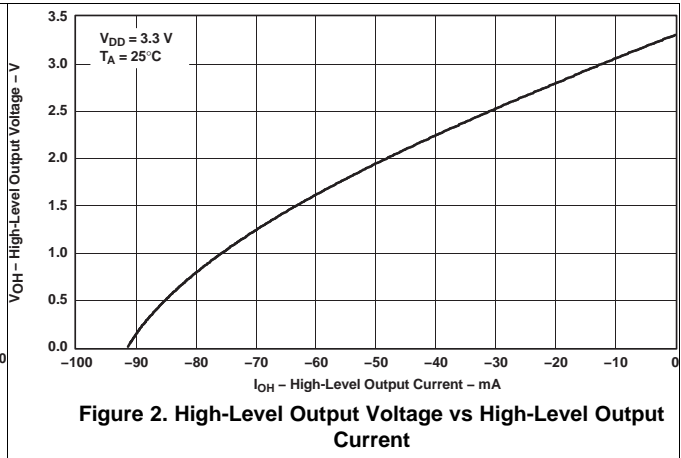
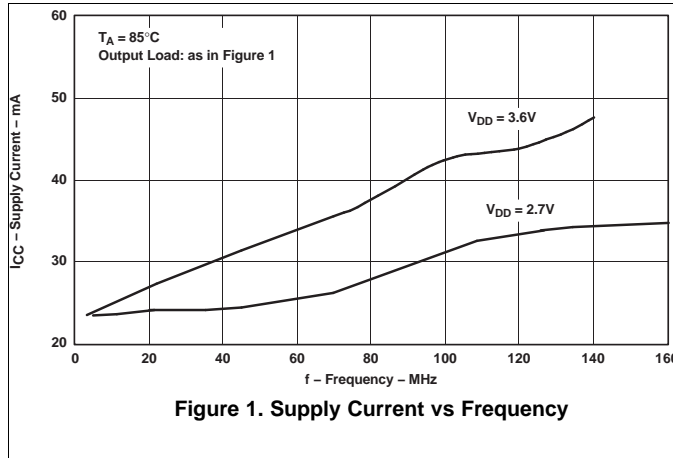

## 6 Parameter Measurement Information

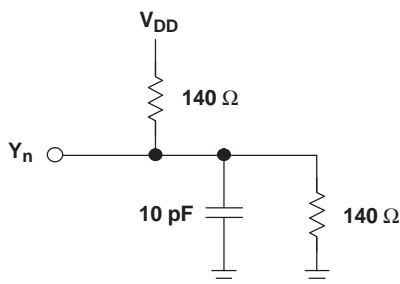

Figure 4. Test Load Circuit

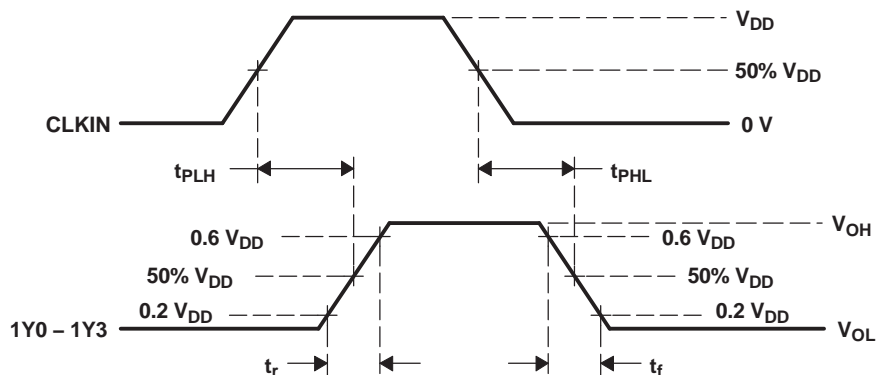

Figure 5. Voltage Waveforms Propagation Delay ( $t_{pd}$ ) Measurements

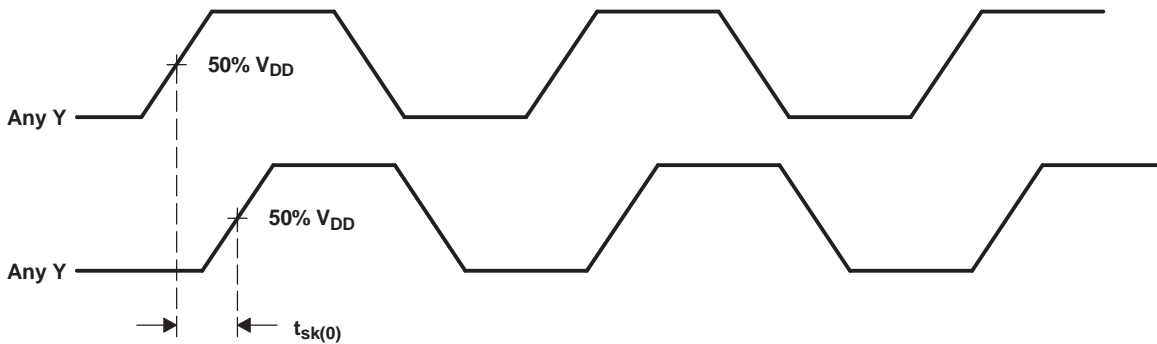
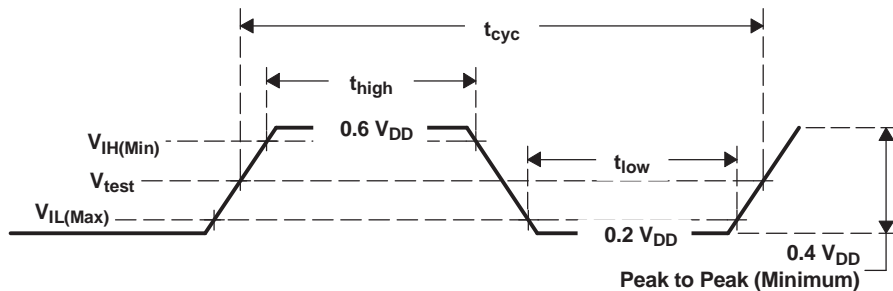

Figure 6. Output Skew

PARAMETER	VALUE	UNIT
$V_{IH(\text{Min})}$	$0.5 V_{DD}$	V
$V_{IL(\text{Max})}$	$0.35 V_{DD}$	V
$V_{\text{test}}$	$0.4 V_{DD}$	V



A. All parameters in Figure 7 are according to PCI-X 1.0 specifications.

Figure 7. Clock Waveform

## 7 Detailed Description

### 7.1 Functional Block Diagram

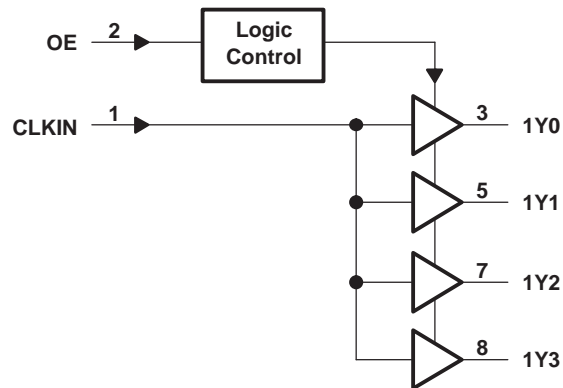

### 7.2 Device Functional Modes

**Table 1. Function Table**

INPUTS		OUTPUTS
CLKIN	OE	1Y[0:3]
L	L	L
H	L	L
L	H	L
H	H	H

## 8 Device and Documentation Support

### 8.1 Receiving Notification of Documentation Updates

To receive notification of documentation updates, navigate to the device product folder on ti.com. In the upper right corner, click on *Alert me* to register and receive a weekly digest of any product information that has changed. For change details, review the revision history included in any revised document.

### 8.2 Community Resources

The following links connect to TI community resources. Linked contents are provided "AS IS" by the respective contributors. They do not constitute TI specifications and do not necessarily reflect TI's views; see TI's [Terms of Use](#).

**TI E2E™ Online Community** *TI's Engineer-to-Engineer (E2E) Community*. Created to foster collaboration among engineers. At e2e.ti.com, you can ask questions, share knowledge, explore ideas and help solve problems with fellow engineers.

**Design Support** *TI's Design Support* Quickly find helpful E2E forums along with design support tools and contact information for technical support.

### 8.3 Trademarks

E2E is a trademark of Texas Instruments.  
All other trademarks are the property of their respective owners.

### 8.4 Electrostatic Discharge Caution



This integrated circuit can be damaged by ESD. Texas Instruments recommends that all integrated circuits be handled with appropriate precautions. Failure to observe proper handling and installation procedures can cause damage.

ESD damage can range from subtle performance degradation to complete device failure. Precision integrated circuits may be more susceptible to damage because very small parametric changes could cause the device not to meet its published specifications.

### 8.5 Glossary

[SLYZ022](#) — *TI Glossary*.

This glossary lists and explains terms, acronyms, and definitions.

## 9 Mechanical, Packaging, and Orderable Information

The following pages include mechanical, packaging, and orderable information. This information is the most current data available for the designated devices. This data is subject to change without notice and revision of this document. For browser-based versions of this data sheet, refer to the left-hand navigation.

**PACKAGING INFORMATION**

Orderable Device	Status (1)	Package Type	Package Drawing	Pins	Package Qty	Eco Plan (2)	Lead finish/ Ball material (6)	MSL Peak Temp (3)	Op Temp (°C)	Device Marking (4/5)	Samples
CDCV304PW	ACTIVE	TSSOP	PW	8	150	RoHS & Green	NIPDAU	Level-1-260C-UNLIM	-40 to 85	CKV304	<a href="#">Samples</a>
CDCV304PWG4	ACTIVE	TSSOP	PW	8	150	RoHS & Green	NIPDAU	Level-1-260C-UNLIM	-40 to 85	CKV304	<a href="#">Samples</a>
CDCV304PWR	ACTIVE	TSSOP	PW	8	2000	RoHS & Green	NIPDAU	Level-1-260C-UNLIM	-40 to 85	CKV304	<a href="#">Samples</a>
CDCV304PWRG4	ACTIVE	TSSOP	PW	8	2000	RoHS & Green	NIPDAU	Level-1-260C-UNLIM	-40 to 85	CKV304	<a href="#">Samples</a>

(1) The marketing status values are defined as follows:

**ACTIVE:** Product device recommended for new designs.

**LIFEBUY:** TI has announced that the device will be discontinued, and a lifetime-buy period is in effect.

**NRND:** Not recommended for new designs. Device is in production to support existing customers, but TI does not recommend using this part in a new design.

**PREVIEW:** Device has been announced but is not in production. Samples may or may not be available.

**OBSELETE:** TI has discontinued the production of the device.

(2) **RoHS:** TI defines "RoHS" to mean semiconductor products that are compliant with the current EU RoHS requirements for all 10 RoHS substances, including the requirement that RoHS substance do not exceed 0.1% by weight in homogeneous materials. Where designed to be soldered at high temperatures, "RoHS" products are suitable for use in specified lead-free processes. TI may reference these types of products as "Pb-Free".

**RoHS Exempt:** TI defines "RoHS Exempt" to mean products that contain lead but are compliant with EU RoHS pursuant to a specific EU RoHS exemption.

**Green:** TI defines "Green" to mean the content of Chlorine (Cl) and Bromine (Br) based flame retardants meet JS709B low halogen requirements of <=1000ppm threshold. Antimony trioxide based flame retardants must also meet the <=1000ppm threshold requirement.

(3) MSL, Peak Temp. - The Moisture Sensitivity Level rating according to the JEDEC industry standard classifications, and peak solder temperature.

(4) There may be additional marking, which relates to the logo, the lot trace code information, or the environmental category on the device.

(5) Multiple Device Markings will be inside parentheses. Only one Device Marking contained in parentheses and separated by a "-" will appear on a device. If a line is indented then it is a continuation of the previous line and the two combined represent the entire Device Marking for that device.

(6) Lead finish/Ball material - Orderable Devices may have multiple material finish options. Finish options are separated by a vertical ruled line. Lead finish/Ball material values may wrap to two lines if the finish value exceeds the maximum column width.

**Important Information and Disclaimer:**The information provided on this page represents TI's knowledge and belief as of the date that it is provided. TI bases its knowledge and belief on information provided by third parties, and makes no representation or warranty as to the accuracy of such information. Efforts are underway to better integrate information from third parties. TI has taken and

continues to take reasonable steps to provide representative and accurate information but may not have conducted destructive testing or chemical analysis on incoming materials and chemicals. TI and TI suppliers consider certain information to be proprietary, and thus CAS numbers and other limited information may not be available for release.

In no event shall TI's liability arising out of such information exceed the total purchase price of the TI part(s) at issue in this document sold by TI to Customer on an annual basis.

**OTHER QUALIFIED VERSIONS OF CDCV304 :**

- Enhanced Product: [CDCV304-EP](#)

**NOTE: Qualified Version Definitions:**

- Enhanced Product - Supports Defense, Aerospace and Medical Applications

**TAPE AND REEL INFORMATION**

**QUADRANT ASSIGNMENTS FOR PIN 1 ORIENTATION IN TAPE**

\*All dimensions are nominal

Device	Package Type	Package Drawing	Pins	SPQ	Reel Diameter (mm)	Reel Width W1 (mm)	A0 (mm)	B0 (mm)	K0 (mm)	P1 (mm)	W (mm)	Pin1 Quadrant
CDCV304PWR	TSSOP	PW	8	2000	330.0	12.4	7.0	3.6	1.6	8.0	12.0	Q1

**TAPE AND REEL BOX DIMENSIONS**

\*All dimensions are nominal

Device	Package Type	Package Drawing	Pins	SPQ	Length (mm)	Width (mm)	Height (mm)
CDCV304PWR	TSSOP	PW	8	2000	853.0	449.0	35.0

**TUBE**

\*All dimensions are nominal

Device	Package Name	Package Type	Pins	SPQ	L (mm)	W (mm)	T (μm)	B (mm)
CDCV304PW	PW	TSSOP	8	150	530	10.2	3600	3.5
CDCV304PWG4	PW	TSSOP	8	150	530	10.2	3600	3.5

PW0008A

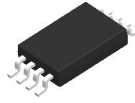

**PACKAGE OUTLINE**  
**TSSOP - 1.2 mm max height**

SMALL OUTLINE PACKAGE

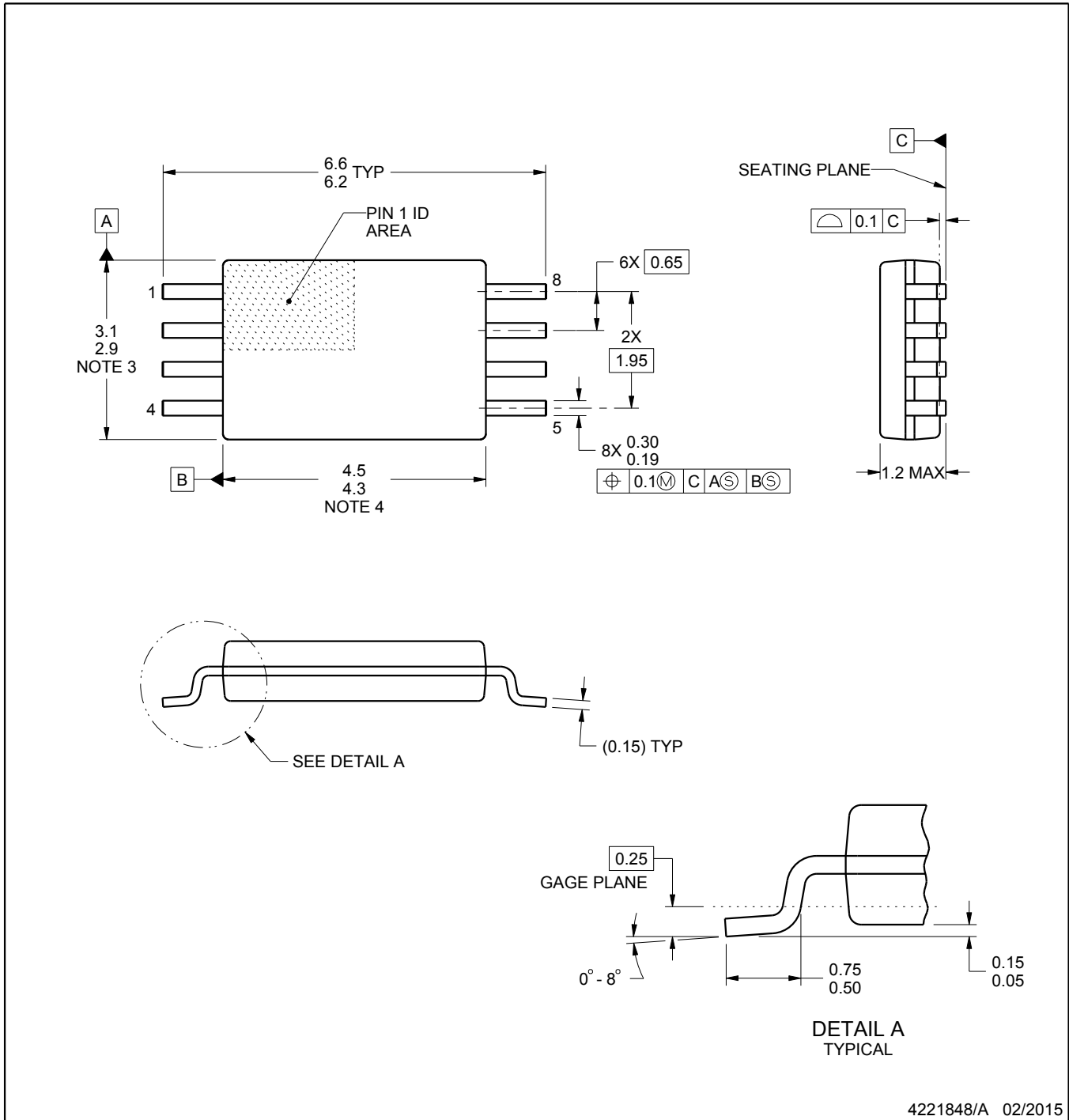

4221848/A 02/2015

NOTES:

- All linear dimensions are in millimeters. Any dimensions in parenthesis are for reference only. Dimensioning and tolerancing per ASME Y14.5M.
- This drawing is subject to change without notice.
- This dimension does not include mold flash, protrusions, or gate burrs. Mold flash, protrusions, or gate burrs shall not exceed 0.15 mm per side.
- This dimension does not include interlead flash. Interlead flash shall not exceed 0.25 mm per side.
- Reference JEDEC registration MO-153, variation AA.

# EXAMPLE BOARD LAYOUT

PW0008A

TSSOP - 1.2 mm max height

SMALL OUTLINE PACKAGE

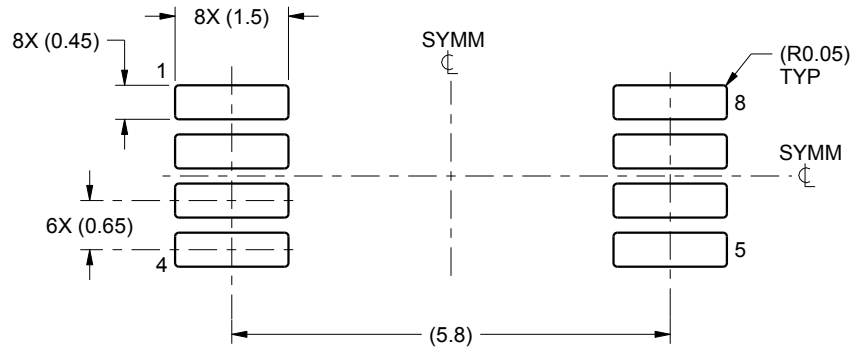

LAND PATTERN EXAMPLE  
SCALE:10X

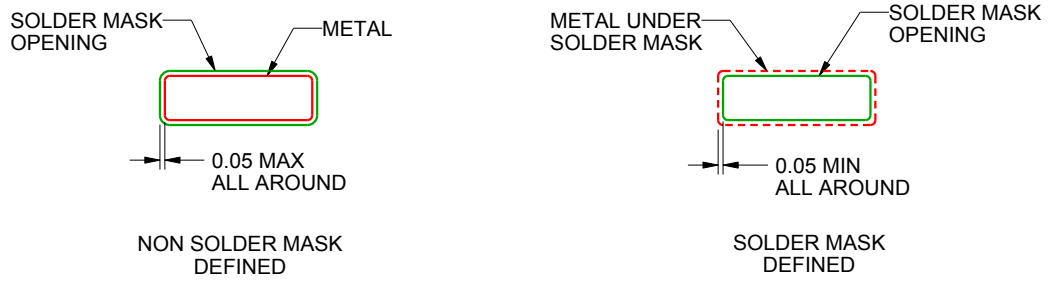

SOLDER MASK DETAILS  
NOT TO SCALE

4221848/A 02/2015

NOTES: (continued)

- 6. Publication IPC-7351 may have alternate designs.
- 7. Solder mask tolerances between and around signal pads can vary based on board fabrication site.

# EXAMPLE STENCIL DESIGN

PW0008A

TSSOP - 1.2 mm max height

SMALL OUTLINE PACKAGE



SOLDER PASTE EXAMPLE  
BASED ON 0.125 mm THICK STENCIL  
SCALE:10X

4221848/A 02/2015

NOTES: (continued)

8. Laser cutting apertures with trapezoidal walls and rounded corners may offer better paste release. IPC-7525 may have alternate design recommendations.
9. Board assembly site may have different recommendations for stencil design.

## IMPORTANT NOTICE AND DISCLAIMER

TI PROVIDES TECHNICAL AND RELIABILITY DATA (INCLUDING DATA SHEETS), DESIGN RESOURCES (INCLUDING REFERENCE DESIGNS), APPLICATION OR OTHER DESIGN ADVICE, WEB TOOLS, SAFETY INFORMATION, AND OTHER RESOURCES "AS IS" AND WITH ALL FAULTS, AND DISCLAIMS ALL WARRANTIES, EXPRESS AND IMPLIED, INCLUDING WITHOUT LIMITATION ANY IMPLIED WARRANTIES OF MERCHANTABILITY, FITNESS FOR A PARTICULAR PURPOSE OR NON-INFRINGEMENT OF THIRD PARTY INTELLECTUAL PROPERTY RIGHTS.

These resources are intended for skilled developers designing with TI products. You are solely responsible for (1) selecting the appropriate TI products for your application, (2) designing, validating and testing your application, and (3) ensuring your application meets applicable standards, and any other safety, security, regulatory or other requirements.

These resources are subject to change without notice. TI grants you permission to use these resources only for development of an application that uses the TI products described in the resource. Other reproduction and display of these resources is prohibited. No license is granted to any other TI intellectual property right or to any third party intellectual property right. TI disclaims responsibility for, and you will fully indemnify TI and its representatives against, any claims, damages, costs, losses, and liabilities arising out of your use of these resources.

TI's products are provided subject to [TI's Terms of Sale](#) or other applicable terms available either on [ti.com](http://ti.com) or provided in conjunction with such TI products. TI's provision of these resources does not expand or otherwise alter TI's applicable warranties or warranty disclaimers for TI products.

TI objects to and rejects any additional or different terms you may have proposed.

Mailing Address: Texas Instruments, Post Office Box 655303, Dallas, Texas 75265  
Copyright © 2022, Texas Instruments Incorporated