

CD54/74HC240, CD54/74HCT240, CD74HC241, CD54/74HCT241, CD54/74HC244, CD54/74HCT244

High-Speed CMOS Logic Octal Buffer/Line Drivers, Three-State

Features

- HC/HCT240 Inverting
- HC/HCT241 Non-Inverting
- HC/HCT244 Non-Inverting
- Typical Propagation Delay = 8ns at $V_{CC} = 5V$, $C_L = 15pF$, $T_A = 25^\circ C$ for HC240
- Three-State Outputs
- Buffered Inputs
- High-Current Bus Driver Outputs
- Fanout (Over Temperature Range)
 - Standard Outputs 10 LSTTL Loads
 - Bus Driver Outputs 15 LSTTL Loads
- Wide Operating Temperature Range . . . $-55^\circ C$ to $125^\circ C$
- Balanced Propagation Delay and Transition Times
- Significant Power Reduction Compared to LSTTL Logic ICs
- HC Types
 - 2V to 6V Operation
 - High Noise Immunity: $N_{IL} = 30\%$, $N_{IH} = 30\%$ of V_{CC} at $V_{CC} = 5V$
- HCT Types
 - 4.5V to 5.5V Operation
 - Direct LSTTL Input Logic Compatibility, $V_{IL} = 0.8V$ (Max), $V_{IH} = 2V$ (Min)
 - CMOS Input Compatibility, $I_I \leq 1\mu A$ at V_{OL} , V_{OH}

Description

The 'HC240 and 'HCT240 are inverting three-state buffers having two active-low output enables. The CD74HC241, 'HCT241, 'HC244 and 'HCT244 are non-inverting three-state buffers that differ only in that the 241 has one active-high and one active-low output enable, and the 244 has two active-low output enables. All three types have identical pinouts.

Ordering Information

PART NUMBER	TEMP. RANGE (°C)	PACKAGE
CD54HC240F3A	-55 to 125	20 Ld CERDIP
CD54HC244F3A	-55 to 125	20 Ld CERDIP
CD54HCT240F3A	-55 to 125	20 Ld CERDIP
CD54HCT241F3A	-55 to 125	20 Ld CERDIP
CD54HCT244F3A	-55 to 125	20 Ld CERDIP
CD74HC240E	-55 to 125	20 Ld PDIP
CD74HC240M	-55 to 125	20 Ld SOIC
CD74HC240M96	-55 to 125	20 Ld SOIC
CD74HC241E	-55 to 125	20 Ld PDIP
CD74HC241M	-55 to 125	20 Ld SOIC
CD74HC241M96	-55 to 125	20 Ld SOIC
CD74HC244E	-55 to 125	20 Ld PDIP
CD74HC244M	-55 to 125	20 Ld SOIC
CD74HC244M96	-55 to 125	20 Ld SOIC
CD74HCT240E	-55 to 125	20 Ld PDIP
CD74HCT240M	-55 to 125	20 Ld SOIC
CD74HCT240M96	-55 to 125	20 Ld SOIC
CD74HCT240PW	-55 to 125	20 Ld TSSOP
CD74HCT240PWR	-55 to 125	20 Ld TSSOP
CD74HCT240PWT	-55 to 125	20 Ld TSSOP
CD74HCT241E	-55 to 125	20 Ld PDIP
CD74HCT241M	-55 to 125	20 Ld SOIC
CD74HCT241M96	-55 to 125	20 Ld SOIC
CD74HCT244E	-55 to 125	20 Ld PDIP
CD74HCT244M	-55 to 125	20 Ld SOIC
CD74HCT244M96	-55 to 125	20 Ld SOIC

NOTE: When ordering, use the entire part number. The suffixes 96 and R denote tape and reel. The suffix T denotes a small-quantity reel of 250.

Pinout

CD54HC240, CD54HCT240, CD54HCT241,
CD54HC244, CD54HCT244
(CERDIP)

CD74HC240, CD74HC241, CD74HCT241,
CD74HC244, CD74HCT244
(PDIP, SOIC)

CD74HCT240,
(PDIP, SOIC, TSSOP)

TOP VIEW

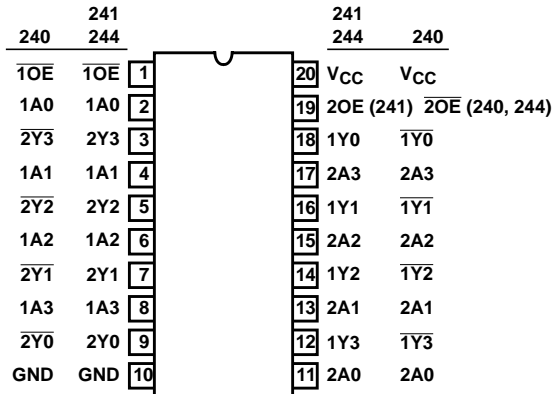

Functional Diagram

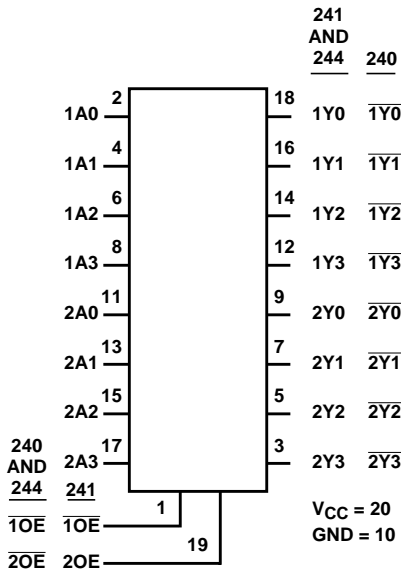

Absolute Maximum Ratings

DC Supply Voltage, V_{CC} -0.5V to 7V
 DC Input Diode Current, I_{IK}
 For $V_I < -0.5V$ or $V_I > V_{CC} + 0.5V$ $\pm 20mA$
 DC Output Diode Current, I_{OK}
 For $V_O < -0.5V$ or $V_O > V_{CC} + 0.5V$ $\pm 20mA$
 DC Drain Current, per Output, I_O
 For $-0.5V < V_O < V_{CC} + 0.5V$ $\pm 35mA$
 DC Output Source or Sink Current per Output Pin, I_O
 For $V_O > -0.5V$ or $V_O < V_{CC} + 0.5V$ $\pm 25mA$
 DC V_{CC} or Ground Current, I_{CC} $\pm 70mA$

Thermal Information

Thermal Resistance (Typical, Note 1) θ_{JA}
 E (PDIP) Package 69°C/W
 M (SOIC) Package 58°C/W
 PW (TSSOP) Package 83°C/W
 Maximum Junction Temperature 150°C
 Maximum Storage Temperature Range -65°C to 150°C
 Maximum Lead Temperature (Soldering 10s) 300°C
 (SOIC - Lead Tips Only)

Operating Conditions

Temperature Range (T_A) -55°C to 125°C
 Supply Voltage Range, V_{CC}
 HC Types 2V to 6V
 HCT Types 4.5V to 5.5V
 DC Input or Output Voltage, V_I, V_O 0V to V_{CC}
 Input Rise and Fall Time
 2V 1000ns (Max)
 4.5V 500ns (Max)
 6V 400ns (Max)

CAUTION: Stresses above those listed in "Absolute Maximum Ratings" may cause permanent damage to the device. This is a stress only rating and operation of the device at these or any other conditions above those indicated in the operational sections of this specification is not implied.

NOTE:

1. The package thermal impedance is calculated in accordance with JESD 51-7.

DC Electrical Specifications

PARAMETER	SYMBOL	TEST CONDITIONS		V_{CC} (V)	25°C			-40°C TO 85°C		-55°C TO 125°C		UNITS
		V_I (V)	I_O (mA)		MIN	TYP	MAX	MIN	MAX	MIN	MAX	
HC TYPES												
High Level Input Voltage	V_{IH}	-	-	2	1.5	-	-	1.5	-	1.5	-	V
				4.5	3.15	-	-	3.15	-	3.15	-	V
				6	4.2	-	-	4.2	-	4.2	-	V
Low Level Input Voltage	V_{IL}	-	-	2	-	-	0.5	-	0.5	-	0.5	V
				4.5	-	-	1.35	-	1.35	-	1.35	V
				6	-	-	1.8	-	1.8	-	1.8	V
High Level Output Voltage CMOS Loads	V_{OH}	V_{IH} or V_{IL}	-0.02	2	1.9	-	-	1.9	-	1.9	-	V
			-0.02	4.5	4.4	-	-	4.4	-	4.4	-	V
			-0.02	6	5.9	-	-	5.9	-	5.9	-	V
High Level Output Voltage TTL Loads	V_{OH}	V_{IH} or V_{IL}	-6	4.5	3.98	-	-	3.84	-	3.7	-	V
			-7.8	6	5.48	-	-	5.34	-	5.2	-	V
Low Level Output Voltage CMOS Loads	V_{OL}	V_{IH} or V_{IL}	0.02	2	-	-	0.1	-	0.1	-	0.1	V
			0.02	4.5	-	-	0.1	-	0.1	-	0.1	V
			0.02	6	-	-	0.1	-	0.1	-	0.1	V
Low Level Output Voltage TTL Loads	V_{OL}	V_{IH} or V_{IL}	6	4.5	-	-	0.26	-	0.33	-	0.4	V
			7.8	6	-	-	0.26	-	0.33	-	0.4	V
Input Leakage Current	I_I	V_{CC} or GND	-	6	-	-	± 0.1	-	± 1	-	± 1	μA
Quiescent Device Current	I_{CC}	V_{CC} or GND	0	6	-	-	8	-	80	-	160	μA

DC Electrical Specifications (Continued)

PARAMETER	SYMBOL	TEST CONDITIONS		V _{CC} (V)	25°C			-40°C TO 85°C		-55°C TO 125°C		UNITS
		V _I (V)	I _O (mA)		MIN	TYP	MAX	MIN	MAX	MIN	MAX	
Three-State Leakage Current	I _{OZ}	V _{IL} or V _{IH}	-	6	-	-	±0.5	-	±0.5	-	±10	µA
HCT TYPES												
High Level Input Voltage	V _{IH}	-	-	4.5 to 5.5	2	-	-	2	-	2	-	V
Low Level Input Voltage	V _{IL}	-	-	4.5 to 5.5	-	-	0.8	-	0.8	-	0.8	V
High Level Output Voltage CMOS Loads	V _{OH}	V _{IH} or V _{IL}	-0.02	4.5	4.4	-	-	4.4	-	4.4	-	V
High Level Output Voltage TTL Loads			-6	4.5	3.98	-	-	3.84	-	3.7	-	V
Low Level Output Voltage CMOS Loads	V _{OL}	V _{IH} or V _{IL}	0.02	4.5	-	-	0.1	-	0.1	-	0.1	V
Low Level Output Voltage TTL Loads			6	4.5	-	-	0.26	-	0.33	-	0.4	V
Input Leakage Current	I _I	V _{CC} to GND	0	5.5	-	-	±0.1	-	±1	-	±1	µA
Quiescent Device Current	I _{CC}	V _{CC} or GND	0	5.5	-	-	8	-	80	-	160	µA
Additional Quiescent Device Current Per Input Pin: 1 Unit Load	ΔI _{CC} (Note 2)	V _{CC} -2.1	-	4.5 to 5.5	-	100	360	-	450	-	490	µA
Three-State Leakage Current	I _{OZ}	V _{IL} or V _{IH}	-	5.5	-	-	±0.5	-	±5	-	±10	µA

NOTE:

2. For dual-supply systems theoretical worst case (V_I = 2.4V, V_{CC} = 5.5V) specification is 1.8mA.

HCT Input Loading Table

INPUT	UNIT LOADS
HCT240	
nA0-A3	1.5
$\overline{1}OE$	0.7
$\overline{2}OE$	0.7
HCT241	
nA0-A3	0.7
$\overline{1}OE$	0.7
2OE	1.5
HCT244	
nA0-A3	0.7
$\overline{1}OE$	0.7
$\overline{2}OE$	0.7

NOTE: Unit Load is ΔI_{CC} limit specified in DC Electrical Specifications table, e.g., 360µA max at 25°C.

CD54/74HC240, CD54/74HCT240, CD74HC241, CD54/74HCT241, CD54/74HC244, CD54/74HCT244

Switching Specifications $C_L = 50\text{pF}$, Input $t_r, t_f = 6\text{ns}$

PARAMETER	SYMBOL	TEST CONDITIONS	V _{CC} (V)	25°C			-40°C TO 85°C			-55°C TO 125°C			UNITS
				MIN	TYP	MAX	MIN	TYP	MAX	MIN	TYP	MAX	
HC TYPES													
Propagation Delay Data to Outputs HC240	t_{PLH}, t_{PHL}	$C_L = 50\text{pF}$	2	-	-	100	-	-	125	-	-	150	ns
			4.5	-	-	20	-	-	25	-	-	30	ns
		$C_L = 15\text{pF}$	5	-	8	-	-	-	-	-	-	-	ns
		$C_L = 50\text{pF}$	6	-	-	17	-	-	21	-	-	26	ns
Data to Outputs HC241	t_{PLH}, t_{PHL}	$C_L = 50\text{pF}$	2	-	-	110	-	-	140	-	-	165	ns
			4.5	-	-	22	-	-	28	-	-	33	ns
		$C_L = 15\text{pF}$	5	-	9	-	-	-	-	-	-	-	ns
		$C_L = 50\text{pF}$	6	-	-	19	-	-	24	-	-	28	ns
Data to Outputs HC244	t_{PLH}, t_{PHL}	$C_L = 50\text{pF}$	2	-	-	110	-	-	140	-	-	165	ns
			4.5	-	-	22	-	-	28	-	-	33	ns
		$C_L = 15\text{pF}$	5	-	9	-	-	-	-	-	-	-	ns
		$C_L = 50\text{pF}$	6	-	-	19	-	-	24	-	-	28	ns
Output Enable and Disable Time	t_{THL}, t_{TLH}	$C_L = 50\text{pF}$	2	-	-	150	-	-	190	-	-	225	ns
			4.5	-	-	30	-	-	38	-	-	45	ns
		5	-	12	-	-	-	-	-	-	-	-	ns
		6	-	-	26	-	-	33	-	-	38	ns	
Output Transition Time	t_{TLH}, t_{THL}	$C_L = 50\text{pF}$	2	-	-	60	-	-	75	-	-	90	ns
			4.5	-	-	12	-	-	15	-	-	18	ns
			6	-	-	10	-	-	13	-	-	15	ns
Input Capacitance	C_I	$C_L = 50\text{pF}$	-	10	-	10	-	-	10	-	-	10	pF
Three-State Output Capacitance	C_O	$C_L = 50\text{pF}$	-	-	-	20	-	-	20	-	-	20	pF
Power Dissipation Capacitance (Notes 3, 4)	C_{PD}	$C_L = 15\text{pF}$	5	-	38	-	-	-	-	-	-	-	pF
			5	-	34	-	-	-	-	-	-	-	pF
			5	-	46	-	-	-	-	-	-	-	pF
HCT TYPES													
Propagation Delay Data to Outputs HCT240	t_{PHL}, t_{PLH}	$C_L = 50\text{pF}$	4.5	-	-	22	-	-	28	-	-	33	ns
		$C_L = 15\text{pF}$	5	-	9	-	-	-	-	-	-	-	ns
Data to Outputs HCT241	t_{PHL}, t_{PLH}	$C_L = 50\text{pF}$	4.5	-	-	25	-	-	31	-	-	38	ns
		$C_L = 15\text{pF}$	5	-	10	-	-	-	-	-	-	-	ns
Data to Outputs HCT244	t_{PHL}, t_{PLH}	$C_L = 50\text{pF}$	4.5	-	-	25	-	-	31	-	-	38	ns
		$C_L = 15\text{pF}$	5	-	10	-	-	-	-	-	-	-	ns

Switching Specifications $C_L = 50\text{pF}$, Input $t_r, t_f = 6\text{ns}$ (Continued)

PARAMETER	SYMBOL	TEST CONDITIONS	V_{CC} (V)	25°C			-40°C TO 85°C			-55°C TO 125°C			UNITS
				MIN	TYP	MAX	MIN	TYP	MAX	MIN	TYP	MAX	
Output Enable and Disable Times	t_{TLH}, t_{TLH}	$C_L = 50\text{pF}$	4.5	-	-	30	-	-	38	-	-	45	ns
Output Transition Time	t_{THL}, t_{TLH}	$C_L = 50\text{pF}$	4.5	-	-	12	-	-	15	-	-	18	ns
Input Capacitance	C_I	$C_L = 50\text{pF}$	-	10	-	10	-	-	10	-	-	10	pF
Power Dissipation Capacitance (Notes 3, 4)	C_{PD}												
HCT240		-	5	-	40	-	-	-	-	-	-	-	pF
HCT241		-	5	-	38	-	-	-	-	-	-	-	pF
HCT244		-	5	-	40	-	-	-	-	-	-	-	pF

NOTES:

- C_{PD} is used to determine the dynamic power consumption, per channel.
- $P_D = V_{CC}^2 f_i (C_{PD} + C_L)$ where f_i = Input Frequency, f_o = Output Frequency, C_L = Output Load Capacitance, V_{CC} = Supply Voltage.

Test Circuits and Waveforms

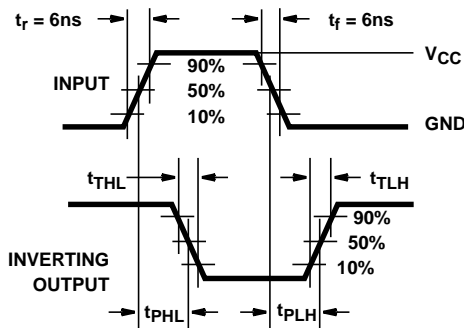

FIGURE 1. HC TRANSITION TIMES AND PROPAGATION DELAY TIMES, COMBINATION LOGIC

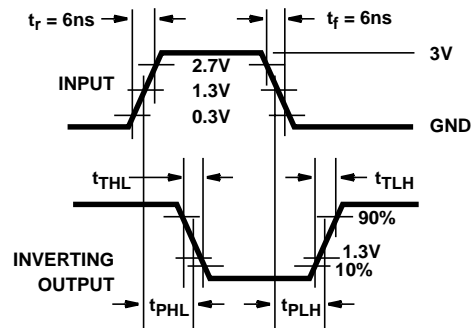

FIGURE 2. HCT TRANSITION TIMES AND PROPAGATION DELAY TIMES, COMBINATION LOGIC

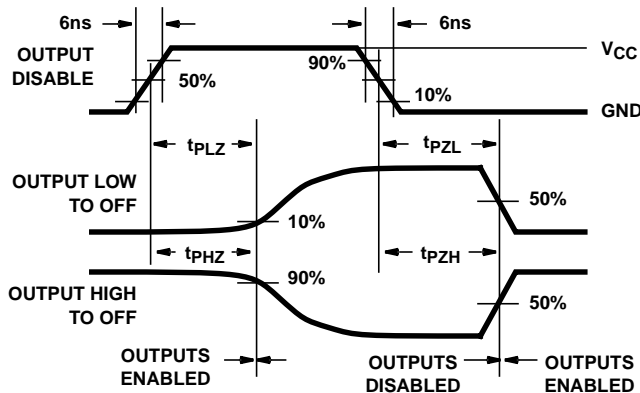

FIGURE 3. HC THREE-STATE PROPAGATION DELAY WAVEFORM

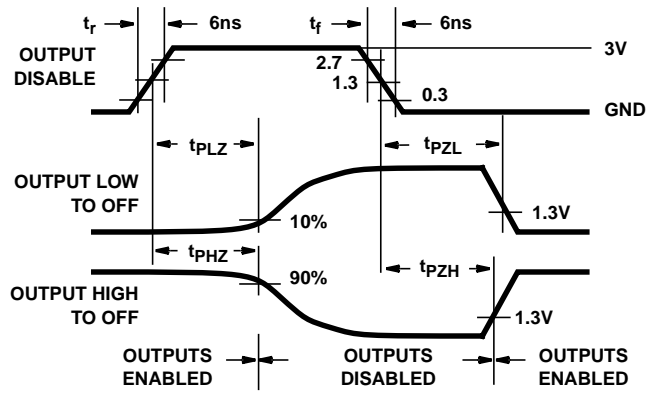
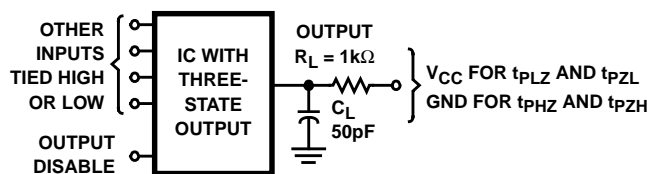

FIGURE 4. HCT THREE-STATE PROPAGATION DELAY WAVEFORM

Test Circuits and Waveforms (Continued)



NOTE: Open drain waveforms t_{pLZ} and t_{pZL} are the same as those for three-state shown on the left. The test circuit is Output $R_L = 1k\Omega$ to V_{CC} , $C_L = 50pF$.

FIGURE 5. HC AND HCT THREE-STATE PROPAGATION DELAY TEST CIRCUIT

PACKAGING INFORMATION

Orderable Device	Status ⁽¹⁾	Package Type	Package Drawing	Pins	Package Qty	Eco Plan ⁽²⁾	Lead/Ball Finish	MSL Peak Temp ⁽³⁾
CD54HC240F3A	ACTIVE	CDIP	J	20	1	TBD	A42 SNPB	N / A for Pkg Type
CD54HC244F	ACTIVE	CDIP	J	20	1	TBD	A42 SNPB	N / A for Pkg Type
CD54HC244F3A	ACTIVE	CDIP	J	20	1	TBD	A42 SNPB	N / A for Pkg Type
CD54HCT240F3A	ACTIVE	CDIP	J	20	1	TBD	A42 SNPB	N / A for Pkg Type
CD54HCT241F3A	ACTIVE	CDIP	J	20	1	TBD	A42 SNPB	N / A for Pkg Type
CD54HCT244F	ACTIVE	CDIP	J	20	1	TBD	A42 SNPB	N / A for Pkg Type
CD54HCT244F3A	ACTIVE	CDIP	J	20	1	TBD	A42 SNPB	N / A for Pkg Type
CD74HC240E	ACTIVE	PDIP	N	20	20	Pb-Free (RoHS)	CU NIPDAU	N / A for Pkg Type
CD74HC240EE4	ACTIVE	PDIP	N	20	20	Pb-Free (RoHS)	CU NIPDAU	N / A for Pkg Type
CD74HC240M	ACTIVE	SOIC	DW	20	25	Green (RoHS & no Sb/Br)	CU NIPDAU	Level-1-260C-UNLIM
CD74HC240M96	ACTIVE	SOIC	DW	20	2000	Green (RoHS & no Sb/Br)	CU NIPDAU	Level-1-260C-UNLIM
CD74HC240M96E4	ACTIVE	SOIC	DW	20	2000	Green (RoHS & no Sb/Br)	CU NIPDAU	Level-1-260C-UNLIM
CD74HC240M96G4	ACTIVE	SOIC	DW	20	2000	Green (RoHS & no Sb/Br)	CU NIPDAU	Level-1-260C-UNLIM
CD74HC240ME4	ACTIVE	SOIC	DW	20	25	Green (RoHS & no Sb/Br)	CU NIPDAU	Level-1-260C-UNLIM
CD74HC240MG4	ACTIVE	SOIC	DW	20	25	Green (RoHS & no Sb/Br)	CU NIPDAU	Level-1-260C-UNLIM
CD74HC241E	ACTIVE	PDIP	N	20	20	Pb-Free (RoHS)	CU NIPDAU	N / A for Pkg Type
CD74HC241EE4	ACTIVE	PDIP	N	20	20	Pb-Free (RoHS)	CU NIPDAU	N / A for Pkg Type
CD74HC241M	ACTIVE	SOIC	DW	20	25	Green (RoHS & no Sb/Br)	CU NIPDAU	Level-1-260C-UNLIM
CD74HC241M96	ACTIVE	SOIC	DW	20	2000	Green (RoHS & no Sb/Br)	CU NIPDAU	Level-1-260C-UNLIM
CD74HC241M96E4	ACTIVE	SOIC	DW	20	2000	Green (RoHS & no Sb/Br)	CU NIPDAU	Level-1-260C-UNLIM
CD74HC241M96G4	ACTIVE	SOIC	DW	20	2000	Green (RoHS & no Sb/Br)	CU NIPDAU	Level-1-260C-UNLIM
CD74HC241ME4	ACTIVE	SOIC	DW	20	25	Green (RoHS & no Sb/Br)	CU NIPDAU	Level-1-260C-UNLIM
CD74HC241MG4	ACTIVE	SOIC	DW	20	25	Green (RoHS & no Sb/Br)	CU NIPDAU	Level-1-260C-UNLIM
CD74HC244E	ACTIVE	PDIP	N	20	20	Pb-Free (RoHS)	CU NIPDAU	N / A for Pkg Type
CD74HC244EE4	ACTIVE	PDIP	N	20	20	Pb-Free (RoHS)	CU NIPDAU	N / A for Pkg Type
CD74HC244M	ACTIVE	SOIC	DW	20	25	Green (RoHS & no Sb/Br)	CU NIPDAU	Level-1-260C-UNLIM
CD74HC244M96	ACTIVE	SOIC	DW	20	2000	Green (RoHS & no Sb/Br)	CU NIPDAU	Level-1-260C-UNLIM
CD74HC244M96E4	ACTIVE	SOIC	DW	20	2000	Green (RoHS & no Sb/Br)	CU NIPDAU	Level-1-260C-UNLIM

Orderable Device	Status ⁽¹⁾	Package Type	Package Drawing	Pins	Package Qty	Eco Plan ⁽²⁾	Lead/Ball Finish	MSL Peak Temp ⁽³⁾
						no Sb/Br)		
CD74HC244M96G4	ACTIVE	SOIC	DW	20	2000	Green (RoHS & no Sb/Br)	CU NIPDAU	Level-1-260C-UNLIM
CD74HC244ME4	ACTIVE	SOIC	DW	20	25	Green (RoHS & no Sb/Br)	CU NIPDAU	Level-1-260C-UNLIM
CD74HC244MG4	ACTIVE	SOIC	DW	20	25	Green (RoHS & no Sb/Br)	CU NIPDAU	Level-1-260C-UNLIM
CD74HCT240E	ACTIVE	PDIP	N	20	20	Pb-Free (RoHS)	CU NIPDAU	N / A for Pkg Type
CD74HCT240EE4	ACTIVE	PDIP	N	20	20	Pb-Free (RoHS)	CU NIPDAU	N / A for Pkg Type
CD74HCT240M	ACTIVE	SOIC	DW	20	25	Green (RoHS & no Sb/Br)	CU NIPDAU	Level-1-260C-UNLIM
CD74HCT240M96	ACTIVE	SOIC	DW	20	2000	Green (RoHS & no Sb/Br)	CU NIPDAU	Level-1-260C-UNLIM
CD74HCT240M96E4	ACTIVE	SOIC	DW	20	2000	Green (RoHS & no Sb/Br)	CU NIPDAU	Level-1-260C-UNLIM
CD74HCT240M96G4	ACTIVE	SOIC	DW	20	2000	Green (RoHS & no Sb/Br)	CU NIPDAU	Level-1-260C-UNLIM
CD74HCT240ME4	ACTIVE	SOIC	DW	20	25	Green (RoHS & no Sb/Br)	CU NIPDAU	Level-1-260C-UNLIM
CD74HCT240MG4	ACTIVE	SOIC	DW	20	25	Green (RoHS & no Sb/Br)	CU NIPDAU	Level-1-260C-UNLIM
CD74HCT240PW	ACTIVE	TSSOP	PW	20	70	Green (RoHS & no Sb/Br)	CU NIPDAU	Level-1-260C-UNLIM
CD74HCT240PWE4	ACTIVE	TSSOP	PW	20	70	Green (RoHS & no Sb/Br)	CU NIPDAU	Level-1-260C-UNLIM
CD74HCT240PWG4	ACTIVE	TSSOP	PW	20	70	Green (RoHS & no Sb/Br)	CU NIPDAU	Level-1-260C-UNLIM
CD74HCT240PWR	ACTIVE	TSSOP	PW	20	2000	Green (RoHS & no Sb/Br)	CU NIPDAU	Level-1-260C-UNLIM
CD74HCT240PWRE4	ACTIVE	TSSOP	PW	20	2000	Green (RoHS & no Sb/Br)	CU NIPDAU	Level-1-260C-UNLIM
CD74HCT240PWG4	ACTIVE	TSSOP	PW	20	2000	Green (RoHS & no Sb/Br)	CU NIPDAU	Level-1-260C-UNLIM
CD74HCT240PWT	ACTIVE	TSSOP	PW	20	250	Green (RoHS & no Sb/Br)	CU NIPDAU	Level-1-260C-UNLIM
CD74HCT240PWTE4	ACTIVE	TSSOP	PW	20	250	Green (RoHS & no Sb/Br)	CU NIPDAU	Level-1-260C-UNLIM
CD74HCT240PWTG4	ACTIVE	TSSOP	PW	20	250	Green (RoHS & no Sb/Br)	CU NIPDAU	Level-1-260C-UNLIM
CD74HCT241E	ACTIVE	PDIP	N	20	20	Pb-Free (RoHS)	CU NIPDAU	N / A for Pkg Type
CD74HCT241EE4	ACTIVE	PDIP	N	20	20	Pb-Free (RoHS)	CU NIPDAU	N / A for Pkg Type
CD74HCT241M	ACTIVE	SOIC	DW	20	25	Green (RoHS & no Sb/Br)	CU NIPDAU	Level-1-260C-UNLIM
CD74HCT241M96	ACTIVE	SOIC	DW	20	2000	Green (RoHS & no Sb/Br)	CU NIPDAU	Level-1-260C-UNLIM
CD74HCT241M96E4	ACTIVE	SOIC	DW	20	2000	Green (RoHS & no Sb/Br)	CU NIPDAU	Level-1-260C-UNLIM

Orderable Device	Status ⁽¹⁾	Package Type	Package Drawing	Pins	Package Qty	Eco Plan ⁽²⁾	Lead/Ball Finish	MSL Peak Temp ⁽³⁾
CD74HCT241M96G4	ACTIVE	SOIC	DW	20	2000	Green (RoHS & no Sb/Br)	CU NIPDAU	Level-1-260C-UNLIM
CD74HCT241ME4	ACTIVE	SOIC	DW	20	25	Green (RoHS & no Sb/Br)	CU NIPDAU	Level-1-260C-UNLIM
CD74HCT241MG4	ACTIVE	SOIC	DW	20	25	Green (RoHS & no Sb/Br)	CU NIPDAU	Level-1-260C-UNLIM
CD74HCT244E	ACTIVE	PDIP	N	20	20	Pb-Free (RoHS)	CU NIPDAU	N / A for Pkg Type
CD74HCT244EE4	ACTIVE	PDIP	N	20	20	Pb-Free (RoHS)	CU NIPDAU	N / A for Pkg Type
CD74HCT244M	ACTIVE	SOIC	DW	20	25	Green (RoHS & no Sb/Br)	CU NIPDAU	Level-1-260C-UNLIM
CD74HCT244M96	ACTIVE	SOIC	DW	20	2000	Green (RoHS & no Sb/Br)	CU NIPDAU	Level-1-260C-UNLIM
CD74HCT244M96E4	ACTIVE	SOIC	DW	20	2000	Green (RoHS & no Sb/Br)	CU NIPDAU	Level-1-260C-UNLIM
CD74HCT244M96G4	ACTIVE	SOIC	DW	20	2000	Green (RoHS & no Sb/Br)	CU NIPDAU	Level-1-260C-UNLIM
CD74HCT244ME4	ACTIVE	SOIC	DW	20	25	Green (RoHS & no Sb/Br)	CU NIPDAU	Level-1-260C-UNLIM
CD74HCT244MG4	ACTIVE	SOIC	DW	20	25	Green (RoHS & no Sb/Br)	CU NIPDAU	Level-1-260C-UNLIM

⁽¹⁾ The marketing status values are defined as follows:

ACTIVE: Product device recommended for new designs.

LIFEBUY: TI has announced that the device will be discontinued, and a lifetime-buy period is in effect.

NRND: Not recommended for new designs. Device is in production to support existing customers, but TI does not recommend using this part in a new design.

PREVIEW: Device has been announced but is not in production. Samples may or may not be available.

OBsolete: TI has discontinued the production of the device.

⁽²⁾ Eco Plan - The planned eco-friendly classification: Pb-Free (RoHS), Pb-Free (RoHS Exempt), or Green (RoHS & no Sb/Br) - please check <http://www.ti.com/productcontent> for the latest availability information and additional product content details.

TBD: The Pb-Free/Green conversion plan has not been defined.

Pb-Free (RoHS): TI's terms "Lead-Free" or "Pb-Free" mean semiconductor products that are compatible with the current RoHS requirements for all 6 substances, including the requirement that lead not exceed 0.1% by weight in homogeneous materials. Where designed to be soldered at high temperatures, TI Pb-Free products are suitable for use in specified lead-free processes.

Pb-Free (RoHS Exempt): This component has a RoHS exemption for either 1) lead-based flip-chip solder bumps used between the die and package, or 2) lead-based die adhesive used between the die and leadframe. The component is otherwise considered Pb-Free (RoHS compatible) as defined above.

Green (RoHS & no Sb/Br): TI defines "Green" to mean Pb-Free (RoHS compatible), and free of Bromine (Br) and Antimony (Sb) based flame retardants (Br or Sb do not exceed 0.1% by weight in homogeneous material)

⁽³⁾ MSL, Peak Temp. -- The Moisture Sensitivity Level rating according to the JEDEC industry standard classifications, and peak solder temperature.

Important Information and Disclaimer: The information provided on this page represents TI's knowledge and belief as of the date that it is provided. TI bases its knowledge and belief on information provided by third parties, and makes no representation or warranty as to the accuracy of such information. Efforts are underway to better integrate information from third parties. TI has taken and continues to take reasonable steps to provide representative and accurate information but may not have conducted destructive testing or chemical analysis on incoming materials and chemicals. TI and TI suppliers consider certain information to be proprietary, and thus CAS numbers and other limited information may not be available for release.

In no event shall TI's liability arising out of such information exceed the total purchase price of the TI part(s) at issue in this document sold by TI to Customer on an annual basis.

TAPE AND REEL INFORMATION



QUADRANT ASSIGNMENTS FOR PIN 1 ORIENTATION IN TAPE

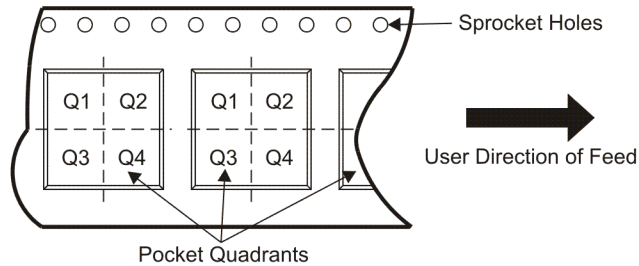

*All dimensions are nominal

Device	Package Type	Package Drawing	Pins	SPQ	Reel Diameter (mm)	Reel Width W1 (mm)	A0 (mm)	B0 (mm)	K0 (mm)	P1 (mm)	W (mm)	Pin1 Quadrant
CD74HC240M96	SOIC	DW	20	2000	330.0	24.4	10.8	13.0	2.7	12.0	24.0	Q1
CD74HC241M96	SOIC	DW	20	2000	330.0	24.4	10.8	13.0	2.7	12.0	24.0	Q1
CD74HC244M96	SOIC	DW	20	2000	330.0	24.4	10.8	13.0	2.7	12.0	24.0	Q1
CD74HCT240M96	SOIC	DW	20	2000	330.0	24.4	10.8	13.0	2.7	12.0	24.0	Q1
CD74HCT240PWR	TSSOP	PW	20	2000	330.0	16.4	6.95	7.1	1.6	8.0	16.0	Q1
CD74HCT241M96	SOIC	DW	20	2000	330.0	24.4	10.8	13.0	2.7	12.0	24.0	Q1
CD74HCT244M96	SOIC	DW	20	2000	330.0	24.4	10.8	13.0	2.7	12.0	24.0	Q1

TAPE AND REEL BOX DIMENSIONS



*All dimensions are nominal

Device	Package Type	Package Drawing	Pins	SPQ	Length (mm)	Width (mm)	Height (mm)
CD74HC240M96	SOIC	DW	20	2000	346.0	346.0	41.0
CD74HC241M96	SOIC	DW	20	2000	346.0	346.0	41.0
CD74HC244M96	SOIC	DW	20	2000	346.0	346.0	41.0
CD74HCT240M96	SOIC	DW	20	2000	346.0	346.0	41.0
CD74HCT240PWR	TSSOP	PW	20	2000	346.0	346.0	33.0
CD74HCT241M96	SOIC	DW	20	2000	346.0	346.0	41.0
CD74HCT244M96	SOIC	DW	20	2000	346.0	346.0	41.0

PW (R-PDSO-G**)

PLASTIC SMALL-OUTLINE PACKAGE

14 PINS SHOWN



4040064/F 01/97

- NOTES: A. All linear dimensions are in millimeters.
 B. This drawing is subject to change without notice.
 C. Body dimensions do not include mold flash or protrusion not to exceed 0,15.
 D. Falls within JEDEC MO-153

J (R-GDIP-T**)

14 LEADS SHOWN

CERAMIC DUAL IN-LINE PACKAGE



DIM \ PINS **	14	16	18	20
A	0.300 (7,62) BSC	0.300 (7,62) BSC	0.300 (7,62) BSC	0.300 (7,62) BSC
B MAX	0.785 (19,94)	.840 (21,34)	0.960 (24,38)	1.060 (26,92)
B MIN	—	—	—	—
C MAX	0.300 (7,62)	0.300 (7,62)	0.310 (7,87)	0.300 (7,62)
C MIN	0.245 (6,22)	0.245 (6,22)	0.220 (5,59)	0.245 (6,22)



4040083/F 03/03

- NOTES:
- All linear dimensions are in inches (millimeters).
 - This drawing is subject to change without notice.
 - This package is hermetically sealed with a ceramic lid using glass frit.
 - Index point is provided on cap for terminal identification only on press ceramic glass frit seal only.
 - Falls within MIL STD 1835 GDIP1-T14, GDIP1-T16, GDIP1-T18 and GDIP1-T20.

DW (R-PDSO-G20)

PLASTIC SMALL-OUTLINE PACKAGE



- NOTES:
- A. All linear dimensions are in inches (millimeters).
 - B. This drawing is subject to change without notice.
 - C. Body dimensions do not include mold flash or protrusion not to exceed 0.006 (0,15).
 - D. Falls within JEDEC MS-013 variation AC.

N (R-PDIP-T**)

PLASTIC DUAL-IN-LINE PACKAGE

16 PINS SHOWN



- NOTES:
- A. All linear dimensions are in inches (millimeters).
 - B. This drawing is subject to change without notice.
 - $\triangle C$ Falls within JEDEC MS-001, except 18 and 20 pin minimum body length (Dim A).
 - $\triangle D$ The 20 pin end lead shoulder width is a vendor option, either half or full width.

4040049/E 12/2002

IMPORTANT NOTICE

Texas Instruments Incorporated and its subsidiaries (TI) reserve the right to make corrections, modifications, enhancements, improvements, and other changes to its products and services at any time and to discontinue any product or service without notice. Customers should obtain the latest relevant information before placing orders and should verify that such information is current and complete. All products are sold subject to TI's terms and conditions of sale supplied at the time of order acknowledgment.

TI warrants performance of its hardware products to the specifications applicable at the time of sale in accordance with TI's standard warranty. Testing and other quality control techniques are used to the extent TI deems necessary to support this warranty. Except where mandated by government requirements, testing of all parameters of each product is not necessarily performed.

TI assumes no liability for applications assistance or customer product design. Customers are responsible for their products and applications using TI components. To minimize the risks associated with customer products and applications, customers should provide adequate design and operating safeguards.

TI does not warrant or represent that any license, either express or implied, is granted under any TI patent right, copyright, mask work right, or other TI intellectual property right relating to any combination, machine, or process in which TI products or services are used. Information published by TI regarding third-party products or services does not constitute a license from TI to use such products or services or a warranty or endorsement thereof. Use of such information may require a license from a third party under the patents or other intellectual property of the third party, or a license from TI under the patents or other intellectual property of TI.

Reproduction of TI information in TI data books or data sheets is permissible only if reproduction is without alteration and is accompanied by all associated warranties, conditions, limitations, and notices. Reproduction of this information with alteration is an unfair and deceptive business practice. TI is not responsible or liable for such altered documentation. Information of third parties may be subject to additional restrictions.

Resale of TI products or services with statements different from or beyond the parameters stated by TI for that product or service voids all express and any implied warranties for the associated TI product or service and is an unfair and deceptive business practice. TI is not responsible or liable for any such statements.

TI products are not authorized for use in safety-critical applications (such as life support) where a failure of the TI product would reasonably be expected to cause severe personal injury or death, unless officers of the parties have executed an agreement specifically governing such use. Buyers represent that they have all necessary expertise in the safety and regulatory ramifications of their applications, and acknowledge and agree that they are solely responsible for all legal, regulatory and safety-related requirements concerning their products and any use of TI products in such safety-critical applications, notwithstanding any applications-related information or support that may be provided by TI. Further, Buyers must fully indemnify TI and its representatives against any damages arising out of the use of TI products in such safety-critical applications.

TI products are neither designed nor intended for use in military/aerospace applications or environments unless the TI products are specifically designated by TI as military-grade or "enhanced plastic." Only products designated by TI as military-grade meet military specifications. Buyers acknowledge and agree that any such use of TI products which TI has not designated as military-grade is solely at the Buyer's risk, and that they are solely responsible for compliance with all legal and regulatory requirements in connection with such use.

TI products are neither designed nor intended for use in automotive applications or environments unless the specific TI products are designated by TI as compliant with ISO/TS 16949 requirements. Buyers acknowledge and agree that, if they use any non-designated products in automotive applications, TI will not be responsible for any failure to meet such requirements.

Following are URLs where you can obtain information on other Texas Instruments products and application solutions:

Products

Amplifiers	amplifier.ti.com
Data Converters	dataconverter.ti.com
DSP	dsp.ti.com
Clocks and Timers	www.ti.com/clocks
Interface	interface.ti.com
Logic	logic.ti.com
Power Mgmt	power.ti.com
Microcontrollers	microcontroller.ti.com
RFID	www.ti-rfid.com
RF/IF and ZigBee® Solutions	www.ti.com/lprf

Applications

Audio	www.ti.com/audio
Automotive	www.ti.com/automotive
Broadband	www.ti.com/broadband
Digital Control	www.ti.com/digitalcontrol
Medical	www.ti.com/medical
Military	www.ti.com/military
Optical Networking	www.ti.com/opticalnetwork
Security	www.ti.com/security
Telephony	www.ti.com/telephony
Video & Imaging	www.ti.com/video
Wireless	www.ti.com/wireless

Mailing Address: Texas Instruments, Post Office Box 655303, Dallas, Texas 75265
Copyright © 2008, Texas Instruments Incorporated