

C-Series Circuit Breaker

The C-Series hydraulic/magnetic circuit breakers are ideal for applications that require higher amperage and voltage handling capability in a smaller package. They are available in 1-6 poles, 0.02-100amps, UL Recognized up to 480VAC or 150VDC, UL489 Listed up to 240VAC or 125VDC, with choice of time delays, terminal options, actuator styles and colors.

Product Highlights:

- ♦ The UL489 C-Series employs a unique arc chute design which allows for higher interrupting capacities of up to 10,000 amps. New thermoset glass filled polyester half shell construction provides for increased mechanical and electrical strength. The wiping contacts, mechanical linkage with two step actuation, clean contacts providing high, positive contact pressure and longer contact life
- ♦ Available with American Standard or Metric Threaded Stud terminals, or Saddle Clamp screw terminals. Optional mid-trip handle style actuator allows visual indication of electrical overload with or without alarm feature
- ♦ Available with new solid color rocker actuators and unique two-color Visi-rocker® actuators, which can be specified to indicate either the ON or TRIPPED/OFF mode
- ♦ Exclusive Rockerguard and Push-To-Reset bezel help prevent inadvertent actuation



HANDLE ACTUATOR



METAL TOGGLE ACTUATOR



PARALLEL POLE ACTUATOR

Agency Certifications:

UL Recognized
UL Standard 1077 | UL Standard 508
UL Standard 1500
UL Listed
UL Standard 489 | UL Standard 489A
CSA Accepted | CSA Certified
TUV Certified | VDE Certified

* For full Agency Certifications, please see pg. 6



Carling Technologies®

Innovative Designs. Powerful Solutions.

innovative designs. powerful solutions.

Carling Technologies, Inc.
60 Johnson Avenue • Plainville, CT 06062-1177
Phone: (860) 793-9281 • Fax: (860) 793-9231
Email: sales@carlingtech.com • www.carlingtech.com

Electrical Tables

Table A: Lists UL Recognized & CSA Accepted configurations and performance capabilities as a Component Supplementary Protector

C-SERIES TABLE A: COMPONENT SUPPLEMENTARY PROTECTORS											
CIRCUIT CONFIGURATION	VOLTAGE			CURRENT RATING		SHORT CIRCUIT CAPACITY (AMPS)		APPLICATION CODES		NOTES	
	MAX. RATING	FREQUENCY	PHASE	FULL LOAD AMPS	GENERAL PURPOSE AMPS	UL/CSA		UL	CSA		
						WITH BACKUP FUSE ¹	WITHOUT BACKUP FUSE				
SERIES	32	DC	—	0.02 - 100	—	—	5000	TC1, OL1, U2	TC1, OL1, U2		
	48	DC	—	110 - 150	—	—	5000	TC1, OL1, U2	TC1, OL1, U2	Must Have Agency Code "L"	
	65	DC	—	0.02 - 70	—	—	5000	TC1,2, OL1,U1	TC1,2, OL1,U1		
				—	71 -100	—	5000	TC1,2, OL0,U1	TC1,2, OL0,U1		
	80	DC	—	0.02 - 70	—	—	7500	TC1,2, OL1,U1	TC1,2, OL1,U1		
				—	71 -100	—	7500	TC1,2, OL0,U1	TC1,2, OL0,U1		
	80	DC	—	0.02 - 70	—	—	10,000	TC1,2, OL1,U1	TC1,2, OL1,U1	Must Have Agency Code "L"	
				—	71 -100	—	10,000	TC1,2, OL0,U1	TC1,2, OL0,U1	Must Have Agency Code "L"	
	125	DC	—	0.02 - 50	—	—	5000	TC1,2,OL1,U1	TC1,2,OL1,U1	Must Have Agency Code "L"	
	125 / 250	DC	—	0.02 - 50	—	—	5000	TC1,2,OL1,U1	TC1,2,OL1,U1	Must Have Agency Code "L"	
	250	DC	—	0.02 - 50	—	—	5000	TC1,2,OL1,U1	TC1,2,OL1,U1	Must Have Agency Code "L". 2 Pole Break Required for 250 Volts	
	125	50 / 60	1	0.02 - 100	—	—	3000	TC1, OL1, U2	TC1, OL1, U2	Per Pole Rating	
				0.02 - 100	—	—	5000	TC1,2,OL1,U1	TC1,2,OL1,U1	Must Have Agency Code "L"	
	150	DC	—	—	80-100	—	5000	TC1, OLO, U3	—	Agency Code "L"	
	150	DC	—	—	101-175	—	5000	TC, OLO, U3	—	Agency Code "L" Parallel Pole	
	125 / 250	50 / 60	1	0.02 - 100	—	—	3500	TC1, OL1, U2	TC1, OL1, U2		
				0.02 - 50	—	—	3000	TC1,2,OL1,U1	TC1,2,OL1,U1	2 or 3 poles breaking single phase	
				51 - 100	—	—	1000	TC1,2,OL1,U1	TC1,2,OL1,U1	2 or 3 poles breaking single phase	
				0.02 - 100	—	—	5000	TC1,1,OL1,U2	TC1,1,OL1,U2	2 or 3 poles breaking single phase, "L" Agency Code	
	250	50 / 60	1	0.02 - 50	—	—	3500	TC1, OL1, U2	TC1, OL1, U2	Per Pole Rating	
				0.02 - 100	—	—	5000	TC1,2,OL1,U1	TC1,2,OL1,U1	Must Have Agency Code "L"	
				51 - 70	—	5000	—	TC1,2,OL1,C1	TC1,2,OL1,C1		
				0.02 - 100	—	—	3000	TC1, OL0, U2	TC1, OL0, U2		
	250	50 / 60	3	0.02 - 70	—	5000	—	TC1,2,OL1,C1	TC1,2,OL1,C1	3 poles breaking 3 phase	
				0.02 - 90	—	—	5000	TC1,2,OL1,U1	TC1,2,OL1,U1	Must Have Agency Code "L"	
	277	50 / 60	1	0.02 - 50	—	5000	—	TC1,2,OL1,C1	TC1,2,OL1,C1		
	480 / 277	50 / 60	3	0.02 - 30	—	5000	—	TC1,2,OL1,C1	TC1,2,OL1,C1	3 poles breaking 3 phase	
—				31 - 50	5000	—	TC1,2,OL0,C1	TC1,2,OL0,C1			
480	50 / 60	1	0.02 - 30	—	5000	—	TC1,2,OL1,C1	TC1,2,OL1,C1	2 poles breaking 1 phase		
			—	31 - 50	5000	—	TC1,2,OL0,C1	TC1,2,OL0,C1			
DUAL COIL	80	DC	—	0.02 - 50	—	—	7500	TC1,2, OL1,U1	TC1,2, OL1,U1		
	125	50 / 60	1	0.02 - 50	—	—	3000	TC1, OL1, U2	TC1, OL1, U2	Per Pole Rating	
	125 / 250	50 / 60	1	0.02 - 50	—	—	3500	TC1, OL1, U2	TC1, OL1, U2	2 or 3 poles breaking single phase	
				0.02 - 50	—	—	3000	TC1,2,OL1,U1	TC1,2,OL1,U1	2 or 3 poles breaking single phase	
	250	50 / 60	1	0.02 - 50	—	—	3500	TC1, OL1, U2	TC1, OL1, U2	Per Pole Rating	
				0.02 - 50	—	—	3000	TC1, OL0, U2	TC1, OL0, U2	3 poles breaking 3 phase	
277	50 / 60	3	0.02 - 50	—	5000	—	TC1,2,OL1,C1	TC1,2,OL1,C1	3 poles breaking 3 phase		
SHUNT	80	DC	—	0.02 - 50	—	—	7500	TC1,2, OL1,U1	TC1,2, OL1,U1		
	277	50 / 60	1	0.02 - 50	—	5000	—	TC1,2,OL1,C1	TC1,2,OL1,C1		
	250	50 / 60	3	0.02 - 50	—	5000	—	TC1,2,OL1,C1	TC1,2,OL1,C1	3 poles breaking 3 phase	
	480 / 277	50 / 60	3	0.02 - 30	—	5000	—	TC1,2,OL1,C1	TC1,2,OL1,C1	3 poles breaking 3 phase	
				—	31 - 50	5000	—	TC1,2,OL0,C1	TC1,2,OL0,C1		
	480	50 / 60	1	0.02 - 30	—	5000	—	TC1,2,OL1,C1	TC1,2,OL1,C1	2 poles breaking 1 phase	
			—	31 - 50	5000	—	TC1,2,OL0,C1	TC1,2,OL0,C1			
	80	DC	—	0.02 - 50	—	—	7500	TC1,2, OL1,U1	TC1,2, OL1,U1		
	277	50 / 60	1	0.02 - 50	—	5000	—	TC1,2,OL1,C1	TC1,2,OL1,C1		
	250	50 / 60	3	0.02 - 50	—	5000	—	TC1,2,OL1,C1	TC1,2,OL1,C1	3 poles breaking 3 phase	
SWITCH ONLY	65	DC	—	0.02 - 70	—	—	—	—	—		
	80	DC	—	0.02 - 70	—	—	—	—	—		
				—	71 -100	—	—	—	—		
	125	50 / 60	1	0.02 - 100	—	—	—	—	—		
	125 / 250	50 / 60	1	0.02 - 100	—	—	—	—	—	—	2 or 3 poles breaking single phase
				0.02 - 100	—	—	—	—	—	—	
	250	50 / 60	3	0.02 - 70	—	—	—	—	—	—	
				0.02 - 70	—	—	—	—	—	—	—
277	50 / 60	1	0.02 - 50	—	—	—	—	—			
480 / 277	50 / 60	3	0.02 - 30	—	—	—	—	—	3 poles breaking 3 phase		
			—	31 - 50	—	—	—	—	—		

Notes for Table A:

¹ Requires branch circuit backup with a UL LISTED Type K5 or RK5 fuse rated 15A minimum and no more than 4 times full load amps not to exceed 125A for 50 Amp or less rating and not to exceed 175 for 51 through 100 Amp rating

*Manufacturer reserves the right to change product specification without prior notice.

Electrical Tables

Table B: Lists UL Recognized and CSA Accepted configurations and performance capabilities as a Manual Motor Controller.

C-SERIES TABLE B: MANUAL MOTOR CONTROLLERS					
CIRCUIT CONFIGURATION	VOLTAGE			CURRENT RATING	HORSEPOWER RATINGS
	MAX. RATING	FREQUENCY	PHASE	FULL LOAD AMPS	MAX HP
SERIES, SHUNT & RELAY SWITCH ONLY	120 ¹	50 / 60	1	0.02 - 50	7 1/2
	250 ¹	50 / 60	1	0.02 - 20	3
			3	0.02 - 20	5
	277 ¹	50 / 60	1	0.02 - 20	3
480 ²	50 / 60	3	0.02 - 20	5	

Notes for Table B:

- 1 UL recognized and CSA Accepted at 480V refers to 3 & 4 pole versions used in a 3Ø, wye connected circuit or 2-pole version connected with 2 poles breaking. 1Ø and backed up with series fusing as stated above in note 1.
- * Series, Shunt and Relay Trip - Voltage Coil Construction not current coils

Table C: Lists UL Recognized, CSA Accepted, VDE and TUV Certified configurations and performance capabilities as a Component Supplementary Protector.

C-SERIES TABLE C: COMPONENT SUPPLEMENTARY PROTECTORS														
CIRCUIT CONFIGURATION	VOLTAGE			CURRENT RATING		SHORT CIRCUIT CAPACITY (AMPS)						APPLICATION CODES		CONSTRUCTION NOTES
	MAX. RATING	FREQUENCY	PHASE	FULL LOAD AMPS	GENERAL PURPOSE AMPS ¹	UL/CSA		VDE		TUV		UL	CSA	
						WITH BACKUP FUSE	WITHOUT BACKUP FUSE	(Inc) WITH BACKUP FUSE	(Icn) WITHOUT BACKUP FUSE	(Inc) WITH BACKUP FUSE	(Icn) WITHOUT BACKUP FUSE			
SERIES	80	DC	---	0.10 - 70	---	---	7500	---	5000	5000	1500	TC1,2, OL1,U1	TC1,2, OL1,U1	
			---	71 - 100	71 - 100	---	10,000	---	5000	---	5000	TC1,2, OL0,U1	TC1,2, OL0,U1	Agency Code F, H, J or R Only
	250	DC	---	0.10 - 50	---	---	5000	---	---	---	5000	TC1,2, OL1,U1	TC1,2, OL1,U1	Agency Code J or R Only, 2P
			---	0.10 - 70	---	---	5000	3000	1500	3000	1500	TC1,2, OL1,U1	TC1,2, OL1,U1	
		50 / 60	1	0.10 - 100	---	---	5000	---	---	5000	5000	TC1,2, OL1,U1	TC1,2, OL1,U1	Agency Code J or R Only
			3	0.10 - 90	---	---	5000	---	---	5000	5000	TC1,2, OL1,U1	TC1,2, OL1,U1	Agency Code J or R Only
	415	50 / 60	3	0.10 - 30	---	5000	---	3000	1500	3000	1500	TC1,2, OL1,C1	TC1,2, OL1,C1	Rocker
						5000	---	5000	2500	3000	1500	TC1,2, OL1,C1	TC1,2, OL1,C1	Handle/ Agency F, H, J, or R
DUAL COIL	80	DC	---	0.10 - 30	---	---	7500	---	1500	5000	1500	TC1,2, OL1,U1	TC1,2, OL1,U1	
	250	50 / 60	1 & 3	0.10 - 30	---	---	5000	3000	1500	3000	1500	TC1,2, OL1,U1	TC1,2, OL1,U1	
SHUNT	80	DC	---	0.10 - 70	---	---	7500	---	5000	5000	1500	TC1,2, OL1,U1	TC1,2, OL1,U1	
	250	50 / 60	1 & 3	0.10 - 70	---	---	5000	3000	1500	3000	1500	TC1,2, OL1,U1	TC1,2, OL1,U1	
						5000	---	3000	1500	3000	1500	TC1,2, OL1,C1	TC1,2, OL1,C1	Rocker
415	50 / 60	3	0.10 - 30	---	5000	---	5000	2500	3000	1500	TC1,2, OL1,C1	TC1,2, OL1,C1	Handle/ Agency F, H, J, or R	

Notes for Table C:

- 1 General Purpose ratings for UL/CSA only.
- 2 Requires branch circuit backup with a UL LISTED Type K5 or RK5 fuse rated 15A minimum and no more than 4 times full load amps not to exceed 125A for 50 Amp or less rating and not to exceed 175 for 51 through 100 Amp rating.

Electrical Tables

Table D: Lists UL Listed (489), CSA Certified (C22.2 No. 5.1-M) configuration and performance capabilities as a Molded Case Circuit Breaker.

C SERIES TABLE D : UL489 LISTED BRANCH CIRCUIT BREAKERS						
CIRCUIT CONFIGURATION	VOLTAGE			CURRENT RATING FULL LOAD AMPS	INTERRUPTING CAPACITY (AMPS) WITHOUT BACKUP FUSE	CONSTRUCTION NOTES
	MAX. RATING	FREQUENCY	PHASE			
SERIES	80	DC	---	0.10 - 100	50,000 ¹ 10,000	Limited to 2 Poles Max from 71 - 100 Amps. Limited to 2 Poles Max from 71 - 100 Amps.
	125	DC	---	0.10 - 100	5,000	1 - 3 Poles
	125 / 250	DC	---	0.10 - 50	5,000	1 or 2 Poles (2 Poles Required for 250 Volts)
	120	50 / 60	1	0.10 - 50	10,000	1 - 3 Poles
				51 - 70	5,000	1 - 3 Poles
	120 / 240	50 / 60	1	0.10 - 50	5,000	2 or 3 Poles. 1 Pole of a 3 Pole Unit is Neutral
				0.10 - 50	10000 ¹	2 or 3 Poles. 1 Pole of a 3 Pole Unit is Neutral
	240	50 / 60	1	0.10 - 30	5,000	1Pole
240	50 / 60	1	0.10 - 20	5,000	2 Pole	
277	50 / 60	1	0.10 - 20	10,000	1Pole	
DUAL COIL	120	50 / 60	1	0.10 - 30	10,000	---

Notes from Table D:

1 Special catalog number required. Consult factory.

Table E: Lists UL Recognized, CSA Accepted configurations and performance capabilities as Protectors, Supplementary for Marine Electrical and Fuel Systems (Guide PEQ22, File E75596). Ignition Protected per UL 1500. UL Classified Small Craft Electrical Devices, Marine in accordance with ISO 8846 (Guide UZMK, File MQ1515) as Marine Supplementary Protectors.

C-SERIES TABLE E: UL1500 (Marine Ignition Protected)								
CIRCUIT CONFIGURATION	VOLTAGE			CURRENT RATING FULL LOAD AMPS	INTERRUPTING CAPACITY (AMPS) WITHOUT BACKUP FUSE	APPLICATION CODES		CONSTRUCTION NOTES
	MAX. RATING	FREQUENCY	PHASE			UL	CSA	
SERIES	48	DC	---	0.02 - 100	5000	TC1,2,OL1,U1	TC1,2,OL1,U1	--
	65	DC	---	0.02 - 100	5000	TC1,2,OL1,U1	TC1,2,OL1,U1	--
				0.02 - 100	1500	TC1,2,OL0,U1	TC1,2,OL0,U1	--
	80	DC	---	0.02 - 70	1500	TC1,2,OL1,U1	TC1,2,OL1,U1	--
	125	50 / 60	1	0.02 - 70	5000	TC1,2,OL1,U1	TC1,2,OL1,U1	--
				71 - 100	1500	TC1,2,OL1,U1	TC1,2,OL1,U1	--
	250	50 / 60	1	0.02 - 70	1500	TC1,2,OL1,U1	TC1,2,OL1,U1	--
				71 - 100	1500	TC1,2,OL1,U1	TC1,2,OL1,U1	2 Poles Breaking Single Phase

Table F: Lists UL Listed configurations and performance capabilities as Circuit Breakers for use in Communications Equipment (Guide DITT, File E189195), under UL489A.

C-SERIES TABLE F : PARALLEL POLE CONSTRUCTION UL489A LISTED FOR COMMUNICATIONS EQUIPMENT					
CIRCUIT CONFIGURATION	VOLTAGE			CURRENT RATING GENERAL PURPOSE AMPS	INTERRUPTING CAPACITY (AMPS) WITHOUT BACKUP FUSE
	MAX. RATING	FREQUENCY	PHASE		
SERIES	80	DC	---	110 - 250	10,000

Electrical

Maximum Voltage AC, 480 WYE/277 VAC, 50/60 Hz (see Table A.)
UL489: AC, 240 VAC. (Table D), 50/60 Hz, 125 VDC, UL 1077, 150 VDC, 277 VAC

Current Rating Standard current coils: 0.100, 0.250, 0.500, 0.750, 1.00, 2.50, 5.00, 7.50, 10.0, 15.0, 25.0, 30.0, 35.0, 40.0, 50.0, 60.0, 70.0, 80.0, 90.0 and 100 amps. Other ratings available, see Ordering Scheme.

Standard Voltage Coils DC - 6V, 12V; AC - 120V; other ratings available, see Ordering Scheme.

Auxiliary Switch Rating SPDT; 10.1 amps-250VAC, DC Aux. Switch 1.0A, 65 VDC. 0.5A, 80VDC, 1/4 HP, 125VAC, VDE & TUV 1.0 125 VAC.

Insulation Resistance Dielectric Strength Minimum of 100 Megohms at 500 VDC. UL, CSA: 1960 V 50/60 Hz for one minute between all electrically isolated terminals. C-Series Circuit Breakers comply with the 8mm spacing and 3750V 50/60 Hz dielectric requirements from hazardous voltage to operator accessible surfaces, between adjacent poles and from main circuits to auxiliary circuits per Publications EN 60950 and VDE 0805.

Resistance, Impedance Values from Line to Load Terminal based on Series Trip Circuit Breaker.

RESISTANCE, IMPEDANCE VALUES from Line to Load Terminals (Values Based on Series Trip Circuit Breaker)

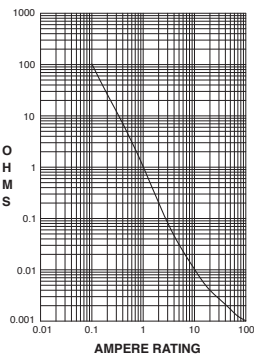

CURRENT (AMPS)	TOLERANCE (%)
0.10 - 5.0	15%
5.1 - 20.0	25%
20.1 - 100.0	35%

Pulse Tolerance Curves

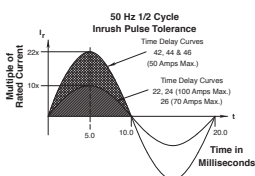
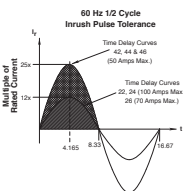

Mechanical

Endurance 10,000 ON-OFF operations @ 6 per minute; with rated current & voltage

Trip Free All C-Series circuit breakers will trip on overload, even when actuator is forcibly held in the ON position.

Trip Indication The operating actuator moves positively to the OFF position when an overload causes the breaker to trip. With mid-trip, handle moves to the mid position on electrical trip of the circuit breaker. With mid trip handle with alarm switch, handle moves to the mid position and the alarm switch actuates when the circuit breaker is electrically tripped.

Physical

Number of Poles 1-6 poles ≤ 50A; 1-4 poles @ 51-70A; 1-2 poles 71-100A. UL489 Handle: 1 pole ≤ 100A, 2 pole ≤ 50A; Rocker: 1 pole ≤ 100A.

Internal Circuit Configuration Series (with or without auxiliary switch, mid trip & mid trip with alarm switch) Shunt & Relay with current or voltage trip coils, Dual Coil, Switch Only (with or without aux. switch). UL489: Series (with or without auxiliary switch, mid-trip & mid-trip with alarm switch).

Weight Approx. 112 grams/pole (3.95 oz).

Standard Colors Housing: Black

Environmental

Designed and tested in accordance with requirements of specification MIL-PRF-55629 & MIL-STD-202 as follows:

Shock Withstands 100 Gs, 6ms sawtooth while carrying rated current per Method 213, Test Condition "I". Instantaneous and ultrashort curves tested @ 90% of rated current.

Vibration Withstands 0.060" excursion from 10-55 Hz & 10 Gs 55-500 Hz, @ rated current per Method 204C, Test Cond. A. Instantaneous & ultrashort curves tested @ 90% of rated current.

Moisture Resistance Method 106D, i.e., ten 24-hour cycles @ +25°C to +65°C, 80-98% RH.

Salt Spray Method 101, Condition A (90-95% RH @ 5% NaCl Solution, 96 hrs). Method 107D, Condition A (five cycles @ -55°C to +25°C to +85°C to +25°C).

Thermal Shock

Operating Temperature -40°C to +85°C

Agency Certifications:

UL Recognized

UL Standard 1077 Component Recognition Program
as Protectors, Supplementary
(Guide CCN/QVNU2, File E75596)



UL Standard 508 Motor Controllers, Manual
(Guide CCN/NLRV2, File E135367)



UL Standard 1500 Protectors, Supplementary for
Marine Electrical & Fuel Systems
(Guide PEQZ2, File E75596)
Ignition Protection



UL Listed

UL Standard 489 Circuit Breakers, Molded Case,
(Guide DIVQ, File E129899)



UL Standard 489A Communications Equipment
(Guide CCN/DITT, File E189195)



CSA Accepted

Component Supplementary Protector
under Class 3215 30,
File 047848 0 000
CSA Standard C22.2 No. 235



CSA Certified

Circuit Breaker Model Case
(Class 1432 01, File 093910),
CSA Standard C22.2 No. 5.1 - M



TUV Certified

EN60934, under License No.
R72041016



VDE Certified

EN60934, VDE 0642 under File No.
10537



8 | C-Series Handle Parallel Pole UL489A Listed – Ordering Scheme

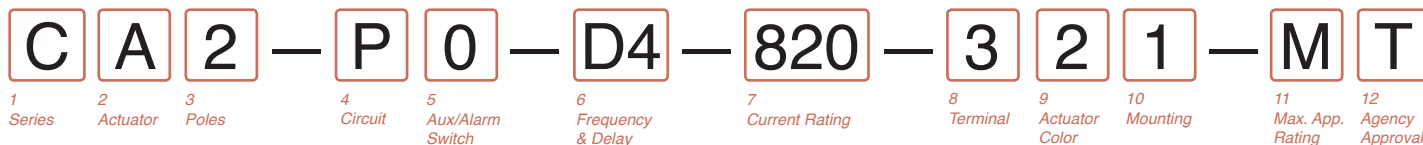

1 SERIES

C

2 ACTUATOR¹

A Handle, one per pole
S Mid-Trip Handle, one per pole
T Mid-Trip, one per pole & Alarm Switch

3 POLES³

2 Two **3** Three

4 CIRCUIT

P Series Trip (parallel pole)

5 AUXILIARY/ALARM SWITCH

0 without Aux Switch	6 S.P.S.T., 0.139 Solder Lug
2 S.P.D.T., 0.110 Q.C. Terminal	8 S.P.S.T., 0.187 Q.C. Terminal
3 S.P.D.T., 0.139 Solder Lug	9 S.P.D.T., 0.187 Q.C. Terminal
4 S.P.D.T., 0.110 Q.C. Terminal (Gold Contacts)	

6 FREQUENCY & DELAY

D1 DC Ultra Short	D4 DC Medium
D2 DC Short	D6 DC Long

7 CURRENT RATING (AMPERES)

CODE	AMPERES			
811	110.000	814 140.000	917 170.000	922³ 225.000
812	120.000	815 150.000	818 180.000	825³ 250.000
912	125.000	816 160.000	819 190.000	
813	130.000	817 170.000	820 200.000	

8 TERMINAL²

3 1/4-20, threaded
6 M6, threaded
A Plug-In Stud

9 ACTUATOR COLOR

LEGEND	Dual	Legend Color
ON-OFF	1	Black
White	2	White
Black	3	White
Red	4	White
Green	5	White
Blue	6	Black
Yellow	7	Black
Gray	8	Black
Orange		

10 MOUNTING/BARRIERS

MOUNTING STYLE
Threaded Insert
1 6-32 x 0.195 inches
2 ISO M3 x 5mm

11 MAXIMUM APPLICATION RATING

M 80 DC

12 AGENCY APPROVAL

T UL489A Listed (up to 250 amps)
K UL489A Listed, VDE Certified (up to 200 amps)
7 UL489A Listed, TUV Certified (up to 250 amps)

Notes:

- 1 Actuator Code:
A: Handle tie pin spacer(s) and retainers provided assembled with multi-pole units.
S: Handle moves to mid-position only upon electrical trip of the breaker.
T: Handle moves to mid-position and alarm switch activates only upon electrical trip of the breaker.
- 2 Terminal Code:
3 & 6: Supplied with bus bars connecting the Line and Load Terminals.
A: Line and Load Terminals must be connected to a copper bus bar having a minimum cross section of 0.078 square inches.
- 3 Above 200 amps, 3 poles are required.

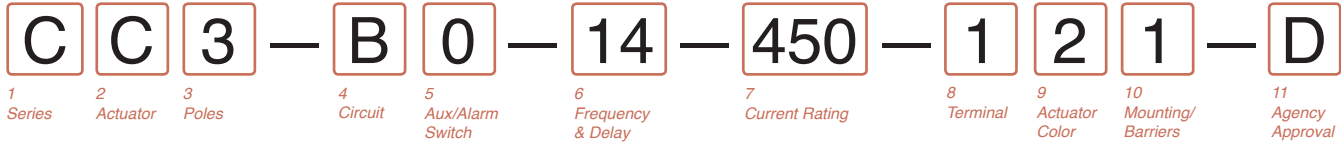

1 SERIES
C

2 ACTUATOR¹

Two Color Visi-Rocker

- C** Indicate ON, vertical legend
- D** Indicate ON, horizontal legend
- E** Indicate ON, no legend
- F** Indicate OFF, vertical legend
- G** Indicate OFF, horizontal legend
- H** Indicate OFF, no legend

Single color

- J** Vertical legend
- K** Horizontal legend
- L** No legend

Push-To-Reset, Single color

- R** Vertical legend
- U** Horizontal legend
- V** No legend

Push-To-Reset, Visi-Rocker

- N** Indicate OFF, vertical legend
- O** Indicate OFF, horizontal legend
- P** Indicate OFF, no legend

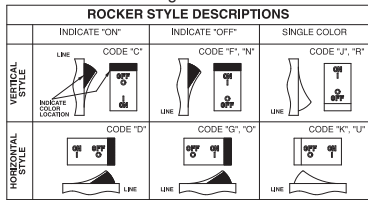

3 POLES²

- 1** One
- 2** Two
- 3** Three

4 CIRCUIT

- A³** Switch Only (No Coil)
- B** Series Trip (Current)
- C** Series Trip (Voltage)
- D⁴** Shunt Trip (Current)
- E⁴** Shunt Trip (Voltage)

- F⁴** Relay Trip (Current)
- G⁴** Relay Trip (Voltage)
- H^{4,5}** Dual Coil with Shunt Trip Voltage Coil
- K^{4,5}** Dual Coil with Relay Trip Voltage Coil

5 AUXILIARY/ALARM SWITCH⁶

- 0** without Aux Switch
- 2** S.P.D.T., 0.110 Q.C. Terminal
- 3** S.P.D.T., 0.139 Solder Lug
- 4** S.P.D.T., 0.110 Q.C. Terminal (Gold Contacts)
- 6** S.P.S.T., 0.139 Solder Lug
- 8** S.P.S.T., 0.187 Q.C. Terminal
- 9** S.P.D.T., 0.187 Q.C. Terminal

6 FREQUENCY & DELAY

- 03** DC 50/60Hz, Switch Only
- 10⁷** DC Instantaneous
- 11** DC Ultra Short
- 12** DC Short
- 14** DC Medium
- 16** DC Long
- 20⁷** 50/60Hz Instantaneous
- 21** 50/60Hz Ultra Short
- 22** 50/60Hz Short
- 24** 50/60Hz Medium
- 26** 50/60Hz Long
- 30** DC 50/60Hz Instantaneous
- 31** DC 50/60Hz Ultra Short
- 32** DC 50/60Hz Short
- 34** DC 50/60Hz Medium
- 36** DC 50/60Hz Long
- 42⁸** 50/60Hz Short, Hi-Inrush
- 44⁸** 50/60Hz Medium, Hi-Inrush
- 46⁸** 50/60Hz Long, Hi-Inrush
- 52⁸** DC Short, Hi-Inrush
- 54⁸** DC Medium, Hi-Inrush
- 56⁸** DC Long, Hi-Inrush

Notes:

- 1 Push-To-Reset actuators have OFF portion of rocker shrouded.
- 2 Multi-pole breakers have all poles identical except when specifying Aux. switch and/or mixed poles, and have one rocker per breaker. Rocker location as viewed from front panel: 2 pole – left pole; 3 pole – center pole.
- 3 Switch Only circuits, rated up to 50 amps and 3 poles, and only available with VDE Certification when tied to a protected pole (Circuit Code B, C, D or H). For 02 to 30 amps, select Current Code 630. For 35 - 50 amps, select Current Code 650. For 55-70 amps, select Current Code 670. For 75-100 amps, select Current Code 810.
- 4 Circuit Codes D,E,F,G,H & K available with Terminal Codes 1,2,4 & 5 only. Circuit Codes D,F,H & K available up to 50 amps maximum Current Rating.
- 5 Consult factory for available Dual Coil options, as special catalog number is required. Dual Coil Voltage Coils with Shunt Trip Construction trip instantaneously on line voltage. Dual Coil Voltage Coils require 30VA minimum power to trip instantaneously and are rated for intermittent duty only. Auxiliary Switch available with Series Trip and Switch Only circuits. On multi-pole breakers, one aux. switch is supplied, mounted in the extreme right pole. Auxiliary switch codes 2,3 & 4 are VDE approved.
- 6 Voltage coils not rated for continuous duty. Available only with delay codes 10 and 20.
- 7 Available with Circuit Codes B & D only, and up to 50 amps maximum.
- 8 Current Ratings 60-70 are available up to four poles maximum. Ratings 71-100 are available up to two poles maximum. Terminal Code 1 available to 60 amps maximum.
- 9 Terminal Codes 2,4,5 & C available to 50 amps maximum.
- 10 Terminal Codes 3,6 & 9 available to 100 amps maximum.
- 11 Terminal Code 7 available to 25 amps maximum.
- 12 Terminal Code A available to 100 amps maximum.
- 13 Terminal Codes 7,8,9 & C are not VDE approved.
- 14 Color shown is visi and legend with remainder of rocker black
- 15 Legend on Push-to-reset bezel/shroud is white when single color rocker is ordered. Dual = ON-OFF/I-O legend with actuator codes C - G, and J, K, N, O, R, & U. None = no legend with actuator codes H, L, P, V. Rocker-guard available with actuator codes C - L. Push-to-reset available with actuator codes N, O, P, R, U, V.
- 16 VDE/TUV approval requires Dual (I-O, ON-OFF) or I-O markings on rocker.
- 17 VDE/TUV: 30 amps max.; UL/CSA: 50 amps max.; Available in 2 - 4 poles only and limited to AC Delays.
- 18 "General Purpose amps" not rated for "full load amps" or to be used in applications with a motor.

7 CURRENT RATING (AMPERES)

CODE	AMPERES				
020	0.020	235	0.350	430	3.000
025	0.025	240	0.400	435	3.500
030	0.030	245	0.450	440	4.000
035	0.035	250	0.500	445	4.500
040	0.040	255	0.550	450	5.000
045	0.045	260	0.600	455	5.500
050	0.050	265	0.650	460	6.000
055	0.055	270	0.700	465	6.500
060	0.060	275	0.750	470	7.000
065	0.065	280	0.800	475	7.500
070	0.070	285	0.850	480	8.000
075	0.075	290	0.900	485	8.500
080	0.080	295	0.950	490	9.000
085	0.085	410	1.000	495	9.500
090	0.090	512	1.250	610	10.000
095	0.095	415	1.500	710	10.500
210	0.100	517	1.750	611	11.000
215	0.150	420	2.000	711	11.500
220	0.200	522	2.250	612	12.000
225	0.250	425	2.500	712	12.500
230	0.300	527	2.750	613	13.000
614	14.000				
615	15.000				
616	16.000				
617	17.000				
618	18.000				
620	20.000				
622	22.000				
624	24.000				
625	25.000				
630	30.000				
635	35.000				
640	40.000				
650	50.000				
660 ⁹	60.000				
670 ⁹	70.000				
680 ⁹	80.000				
685 ⁹	85.000				
690 ⁹	90.000				
695 ⁹	95.000				
810 ⁹	100.000				

VOLTAGE COIL (NOMINAL RATED VOLTAGE)⁷

CODE	RATING				
A06	6DC	A32	32DC	J12	12AC
A12	12DC	A48	48DC	J18	18AC
A18	18DC	A65	65DC	J24	24AC
A24	24DC	J06	6AC	J48	48AC
J65	65AC				
K20	120AC				
L40	240AC				

8 TERMINAL

- 1¹⁰** Stud 10-32, threaded
- 2¹¹** Screw 10-32
- 3¹²** Stud 1/4-20, threaded
- 4¹¹** Stud M5 x 0.8, threaded
- 5¹¹** Screw M5 x 0.8
- 6¹²** Stud M6, threaded
- 7¹³** 0.250 Double Quick Connect
- 8** 1/4" Clip Terminal
- 9** 7/16" Clip Terminal
- A¹⁴** Plug-In Stud
- C** 5/16" Clip Terminal

9 ACTUATOR COLOR & LEGEND^{16,17,18}

Actuator or Visi-Color	Marking:	Marking Color:	Single Color Rocker/Handle	Visi-Rocker	
Color:	I-O	ON-OFF	Dual/None		
White	A	B	1	Black	White
Black	C	D	2	White	n/a
Red	F	G	3	White	Red
Green	H	J	4	White	Green
Blue	K	L	5	White	Blue
Yellow	M	N	6	Black	Yellow
Gray	P	Q	7	Black	Gray
Orange	R	S	8	Black	Orange

10 MOUNTING/BARRIERS¹

	Standard Rocker Bezel	BARRIERS
1	6-32 x 0.195 inches	no
2	6-32 x 0.195 inches	yes
3¹⁹	6-32 x 0.195 inches	yes
4	ISO M3 x 5mm	no
5	ISO M3 x 5mm	yes
6¹⁹	ISO M3 x 5mm	yes
A	6-32 x 0.195 inches	no
C	6-32 x 0.195 inches	yes
E¹⁹	6-32 x 0.195 inches	yes
G	ISO M3 x 5mm	no
J	ISO M3 x 5mm	yes
L¹⁹	ISO M3 x 5mm	yes
B	6-32 x 0.195 inches	no
D	6-32 x 0.195 inches	yes
F¹⁹	6-32 x 0.195 inches	yes
H	ISO M3 x 5mm	no
J	ISO M3 x 5mm	yes
M¹⁹	ISO M3 x 5mm	yes

11 AGENCY APPROVAL

- C** UL Recognized, CSA Accepted
- D** VDE Certified, UL Recognized, CSA Accepted
- E** TUV Certified, UL Recognized, CSA Accepted
- H** UL489 Construction: VDE Certified, UL Recognized, CSA Accepted
- I** UL Rec. STD 1077, UL Rec. 1500 (ignition protected), CSA Accepted
- L** UL489 Construction: UL Recognized, CSA Accepted
- R** UL489 Construction: TUV Certified, UL Recognized, CSA Accepted

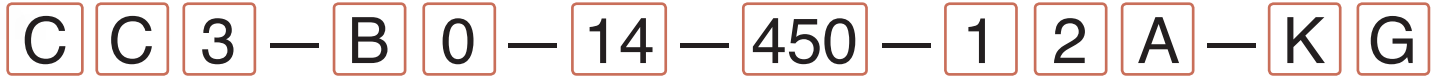

1 Series 2 Actuator 3 Poles 4 Circuit 5 Aux/Alarm Switch 6 Frequency & Delay 7 Current Rating 8 Terminal 9 Actuator Color 10 Mounting/Barriers 11 Max. App. Rating 12 Agency Approval

1 SERIES
C

2 ACTUATOR¹
Two Color Visi-Rocker

C Indicate ON, vertical legend **Single color**
D Indicate ON, horizontal legend J Vertical legend
F Indicate OFF, vertical legend K Horizontal legend
G Indicate OFF, horizontal legend

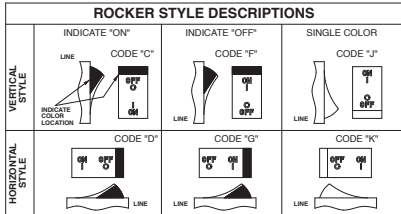

3 POLES¹
1 One 2 Two 3 Three

4 CIRCUIT
B Series Trip (current)

5 AUXILIARY/ALARM SWITCH²

0	without Aux Switch	6	S.P.S.T., 0.139 Solder Lug
2	S.P.D.T., 0.110 Q.C. Terminal	8	S.P.S.T., 0.187 Q.C. Terminal
3	S.P.D.T., 0.139 Solder Lug	9	S.P.D.T., 0.187 Q.C. Terminal
4	S.P.D.T., 0.110 Q.C. Terminal (Gold Contacts)		

6 FREQUENCY & DELAY

11	DC Ultra Short	26	50/60Hz Long
12	DC Short	42 ^B	50/60Hz Short, Hi-Inrush
14	DC Medium	44 ^B	50/60Hz Medium, Hi-Inrush
16	DC Long	46 ^B	50/60Hz Long, Hi-Inrush
21	50/60Hz Ultra Short	52 ^B	DC Short, Hi-Inrush
22	50/60Hz Short	54 ^B	DC Medium, Hi-Inrush
24	50/60Hz Medium	56	DC Long, Hi-Inrush

- Notes:
- Multi-pole breakers have all breakers identical except when specifying Aux. switch and/or mixed poles, and have one rocker per breaker.
 - On multi-pole breakers, one aux. switch is supplied, mounted in the extreme right pole. Available up to 50 amps maximum.
 - Current ratings 71 - 100 with VDE approvals are available up to two poles maximum.
 - Terminal Code 1 available to 60 amps maximum.
 - Terminal Codes 2, 4, 5 & C available to 50 amps maximum.
 - Terminal Codes 3, 6, 9 & A available to 100 amps maximum.
 - Terminal Codes 8, 9 & C are not VDE approved.
 - Color shown is visi and legend with remainder of rocker black
 - Dual = ON-OFF/I-O legend on actuator.
 - VDE and TUV approval requires Dual (I-O, ON-OFF) markings on rocker.
 - Rockerguard available with all actuator codes.
 - Barriers supplied on multi-pole units only.
 - 2 & 3 pole circuit breakers required for 120/240 AC rating.

7 CURRENT RATING (AMPERES)⁴

CODE	AMPERES				
210	0.100	295	0.950	470	7.000
215	0.150	410	1.000	475	7.500
220	0.200	512	1.250	480	8.000
225	0.250	415	1.500	485	8.500
230	0.300	517	1.750	490	9.000
235	0.350	420	2.000	495	9.500
240	0.400	522	2.250	610	10.000
245	0.450	425	2.500	710	10.500
250	0.500	527	2.750	611	11.000
255	0.550	430	3.000	711	11.500
260	0.600	435	3.500	612	12.000
265	0.650	440	4.000	712	12.500
270	0.700	445	4.500	613	13.000
275	0.750	450	5.000	614	14.000
280	0.800	455	5.500	615	15.000
285	0.850	460	6.000	616	16.000
290	0.900	465	6.500	617	17.000

8 TERMINAL

1 ⁵	Stud 10-32, threaded	6 ⁷	Stud M6, threaded
2 ⁶	Screw 10-32 w/saddle & washer clamps	8 ⁸	1/4" Clip Terminal
3 ⁷	Stud 1/4-20, threaded	9 ^{7,8}	7/16" Clip Terminal
4 ⁶	Stud M5 x 0.8, threaded	A ^{7,8}	Plug-In Stud
5 ⁶	Screw M5 x 0.8 w/saddle & washer clamps	C ^{8,9}	5/16" Clip Terminal

9 ACTUATOR COLOR & LEGEND¹¹

Actuator or Visi-Color ⁹	Marking:	Marking Color:
Color:	ON-OFF	Dual¹⁰
White	B	1
Black	D	2
Red	G	3
Green	J	4
Blue	L	5
Yellow	N	6
Gray	Q	7
Orange	S	8

Single Color Rocker/Handle	Visi-Rocker
Black	White
White	n/a
White	Red
White	Green
White	Blue
Black	Yellow
Black	Gray
Black	Orange

10 MOUNTING/BARRIERS¹²

	Standard Rocker Bezel Threaded Insert, 2 per pole	BARRIERS ¹³
A	6-32 x 0.195 inches	yes
C	ISO M3 x 5mm	yes
	Rockerguard Bezel Threaded Insert, 2 per pole	
B	6-32 x 0.195 inches	yes
D	ISO M3 x 5mm	yes

11 MAXIMUM APPLICATION RATING

A	65 DC
B	125 DC
C	120/240 AC ¹⁴
D	240 AC
F	277 AC
K	120 AC
M	80 DC

12 AGENCY APPROVAL

A	without approvals
F	UL 489 Listed, CSA Certified, & VDE Certified
G	UL 489 Listed & CSA Certified
J	UL489 Listed, CSA Certified & TUV Certified



1 SERIES
C

2 ACTUATOR¹

Two Color Visi-Rocker

- 1 Indicate OFF, vertical legend
- 2 Indicate OFF, horizontal legend

Single color

- 3 Vertical legend
- 4 Horizontal legend

Push-To-Reset, Visi-Rocker

- 5 Indicate OFF, vertical legend
- 6 Indicate OFF, horizontal legend

Push-To-Reset, Single color

- 7 Vertical legend
- 8 Horizontal legend

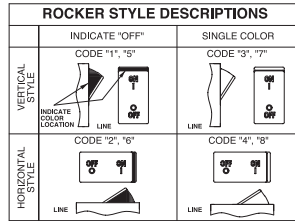

3 POLES²

- 1 One
- 2 Two
- 3 Three

4 CIRCUIT

- A³ Switch Only (No Coil)
- B Series Trip (Current)
- C Series Trip (Voltage)
- D⁴ Shunt Trip (Current)
- E⁴ Shunt Trip (Voltage)
- F⁴ Relay Trip (Current)
- G⁴ Relay Trip (Voltage)
- H^{4,5} Dual Coil with Shunt Trip Voltage Coil
- K^{4,5} Dual Coil with Relay Trip Voltage Coil

5 AUXILIARY/ALARM SWITCH⁶

- 0 without Aux Switch
- 2 S.P.D.T., 0.110 Q.C. Terminal
- 3 S.P.D.T., 0.139 Solder Lug
- 4 S.P.D.T., 0.110 Q.C. Terminal (Gold Contacts)
- 6 S.P.S.T., 0.139 Solder Lug
- 8 S.P.S.T., 0.187 Q.C. Terminal
- 9 S.P.D.T., 0.187 Q.C. Terminal

6 FREQUENCY & DELAY

- 03 DC 50/60Hz, Switch Only
- 10⁷ DC Instantaneous
- 11 DC Ultra Short
- 12 DC Short
- 14 DC Medium
- 16 DC Long
- 20⁷ 50/60Hz Instantaneous
- 21 50/60Hz Ultra Short
- 22 50/60Hz Short
- 24 50/60Hz Medium
- 26 50/60Hz Long
- 30 DC 50/60Hz Instantaneous
- 31 DC 50/60Hz Ultra Short
- 32 DC 50/60Hz Short
- 34 DC 50/60Hz Medium
- 36 DC 50/60Hz Long
- 42⁸ 50/60Hz Short, Hi-Inrush
- 44⁸ 50/60Hz Medium, Hi-Inrush
- 46⁸ 50/60Hz Long, Hi-Inrush
- 52⁸ DC Short, Hi-Inrush
- 54⁸ DC Medium, Hi-Inrush
- 56⁸ DC Long, Hi-Inrush

Notes:

- 1 Push-to-reset actuators have OFF portion of rocker shrouded.
- 2 Multi-pole breakers have all poles identical except when specifying Aux. switch and/or mixed poles, and have one rocker per breaker. Rocker location as viewed from front panel: 2 pole – left pole; 3 pole – center pole.
- 3 Switch Only circuits, rated up to 50 amps and 3 poles, and only available with VDE Certification when tied to a protected pole (Circuit Code B, C, D or H.). For .02 to 30 amps, select Current Code 630. For 35 - 50 amps, select Current Code 650. For 55-70 amps, select Current Code 670. For 75-100 amps, select Current Code 810.
- 4 Circuit Codes D, E, F, G, H & K available with Terminal Codes 1, 2, 4 & 5 only. Circuit Codes D, F, H & K available up to 50 amps maximum Current Rating.
- 5 Consult factory for available Dual Coil options, as special catalog number is required. Dual Coil Voltage Coils with Shunt Trip Construction trip instantaneously on line voltage. Dual Coil Voltage Coils require 30VA minimum power to trip instantaneously and are rated for intermittent duty only.
- 6 Auxiliary Switch available with Series Trip and Switch Only circuits. On multi-pole breakers, one aux. switch is supplied, mounted in the extreme right pole. Auxiliary switch codes 2, 3 & 4 are VDE approved.
- 7 Voltage coils not rated for continuous duty. Available only with delay codes 10 and 20.
- 8 Available with Circuit Codes B & D only, and up to 50 amps maximum.
- 9 Current ratings 60-70 are available up to four poles maximum. Current ratings 71 - 100 are available up to two poles maximum.
- 10 Terminal Code 1 available to 60 amps maximum.
- 11 Terminal Codes 2, 4, 5 & C available to 50 amps maximum.
- 12 Terminal Codes 3, 6 & 9 available to 100 amps maximum.
- 13 Terminal Code 7 available to 25 amps maximum.
- 14 Terminal Code A available to 100 amps maximum.
- 15 Terminal Codes 7, 8, 9 & C are not VDE approved.
- 16 Color shown is visi & legend with remainder of rocker black. Dual = ON-OFF/I-O legend.
- 17 Legend on Push-to-reset bezel/shroud is white with single color actuator codes 7 & 8. Legend on Push-to-reset bezel/shroud matches visi-color of rocker with actuator codes 5 & 6.
- 18 VDE/TUV approval requires Dual (I-O, ON-OFF) or I-O markings on rocker.
- 19 VDE/TUV: 30 amps max.; UL/CSA: 50 amps max.; Available in 2 & 3 poles only and limited to AC Delays.
- 20 "General Purpose amps" not rated for "full load amps" or to be used in applications with a motor.
- 21 Recessed "OFF SIDE" available with actuator codes 1, 2, 3 & 4. Legends on rocker are available in ink stamping only.

7 CURRENT RATING (AMPERES)⁹

CODE	AMPERES				
020	0.020	235	0.350	430	3.000
025	0.025	240	0.400	435	3.500
030	0.030	245	0.450	440	4.000
035	0.035	250	0.500	445	4.500
040	0.040	255	0.550	450	5.000
045	0.045	260	0.600	455	5.500
050	0.050	265	0.650	460	6.000
055	0.055	270	0.700	465	6.500
060	0.060	275	0.750	470	7.000
065	0.065	280	0.800	475	7.500
070	0.070	285	0.850	480	8.000
075	0.075	290	0.900	485	8.500
080	0.080	295	0.950	490	9.000
085	0.085	410	1.000	495	9.500
090	0.090	512	1.250	610	10.000
095	0.095	415	1.500	710	10.500
210	0.100	517	1.750	611	11.000
215	0.150	420	2.000	711	11.500
220	0.200	522	2.250	612	12.000
225	0.250	425	2.500	712	12.500
230	0.300	527	2.750	613	13.000
				614	14.000
				615	15.000
				616	16.000
				617	17.000
				618	18.000
				620	20.000
				622	22.000
				624	24.000
				625	25.000
				630	30.000
				635	35.000
				640	40.000
				650	50.000
				660 ⁹	60.000
				670 ⁹	70.000
				680 ⁹	80.000
				685 ⁹	85.000
				690 ⁹	90.000
				695 ⁹	95.000
				810 ⁹	100.000

VOLTAGE COIL (NOMINAL RATED VOLTAGE)⁷

CODE	RATING				
A06	6DC	A32	32DC	J12	12AC
A12	12DC	A48	48DC	J18	18AC
A18	18DC	A65	65DC	J24	24AC
A24	24DC	J06	6AC	J48	48AC
				J65	65AC
				K20	120AC
				L40	240AC

8 TERMINAL

- 1¹⁰ Stud 10-32, threaded
- 2¹¹ Screw 10-32
- 3¹² Stud 1/4-20, threaded
- 4¹¹ Stud M5 x 0.8, threaded
- 5¹¹ Screw M5 x 0.8
- 6¹² Stud M6, threaded
- 7¹³ 0.250 Double Quick Connect
- 8 1/4" Clip Terminal
- 9 7/16" Clip Terminal
- A¹⁴ Plug-In Stud
- C 5/16" Clip Terminal

9 ACTUATOR COLOR & LEGEND^{15,17,18}

Actuator or Visi-Color	Marking:	Marking Color:	Single Color Rocker/Handle	Visi-Rocker
Color: White	I-O	1	Black	White
Black	A B	2	White	n/a
Red	C D	3	White	Red
Green	F G	4	White	Green
Blue	H J	5	White	Blue
Yellow	K L	6	Black	Yellow
Gray	M N	7	Black	Gray
Orange	P Q	8	Black	Orange
	R S			

10 MOUNTING/BARRIERS¹

	Standard Rocker Bezel	BARRIERS	VOLTAGE
1	6-32 x 0.195 inches	no	< 300
2	6-32 x 0.195 inches	yes	< 300
3 ¹⁹	6-32 x 0.195 inches	yes	≥ 300
4	ISO M3 x 5mm	no	< 300
5	ISO M3 x 5mm	yes	< 300
6 ¹⁹	ISO M3 x 5mm	yes	≥ 300
	Recessed Off Rocker		
7	6-32 x 0.195 inches	no	< 300
8	6-32 x 0.195 inches	yes	< 300
9	6-32 x 0.195 inches	yes	≥ 300
A	ISO M3 x 5mm	no	< 300
C	ISO M3 x 5mm	yes	< 300
E	ISO M3 x 5mm	yes	≥ 300
	Push-To-Reset Bezel		
B	6-32 x 0.195 inches	no	< 300
D	6-32 x 0.195 inches	yes	< 300
F	6-32 x 0.195 inches	yes	≥ 300
H	ISO M3 x 5mm	no	< 300
J	ISO M3 x 5mm	yes	< 300
M ¹⁹	ISO M3 x 5mm	yes	≥ 300

11 AGENCY APPROVAL

- C UL Recognized, CSA Accepted
- E TUV Certified, UL Recognized, CSA Accepted
- I UL Rec. STD 1077, UL Rec. 1500 (ignition protected), CSA Accepted
- L UL489 Construction: UL Recognized, CSA Accepted
- R UL489 Construction: TUV Certified, UL Recognized, CSA Accepted

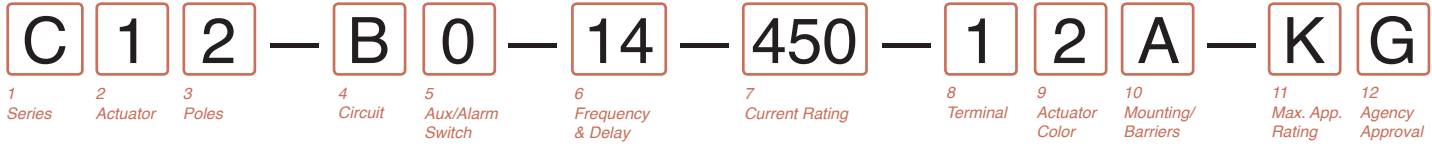

1 SERIES
C

2 ACTUATOR¹

Two Color Visi-Rocker

- 1 Indicate OFF, vertical legend
- 2 Indicate OFF, horizontal legend

Single color

- 3 Vertical legend
- 4 Horizontal legend
- Push-To-Reset, Visi-Rocker**
- 5 Indicate OFF, vertical legend
- 6 Indicate OFF, horizontal legend

Push-To-Reset, Single color

- 7 Vertical legend
- 8 Horizontal legend

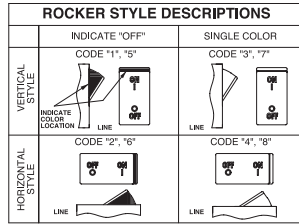

3 POLES²

- 1 One
- 2 Two
- 3 Three

4 CIRCUIT

- B** Series Trip (current)

5 AUXILIARY/ALARM SWITCH²

- 0 without Aux Switch
- 2 S.P.D.T., 0.110 Q.C. Terminal
- 3 S.P.D.T., 0.139 Solder Lug
- 4 S.P.D.T., 0.110 Q.C. Terminal (Gold Contacts)
- 6 S.P.S.T., 0.139 Solder Lug
- 8 S.P.S.T., 0.187 Q.C. Terminal
- 9 S.P.D.T., 0.187 Q.C. Terminal

6 FREQUENCY & DELAY

- 11 DC Ultra Short
- 12 DC Short
- 14 DC Medium
- 16 DC Long
- 21 50/60Hz Ultra Short
- 22 50/60Hz Short
- 24 50/60Hz Medium
- 26 50/60Hz Long
- 42⁴ 50/60Hz Short, Hi-Inrush
- 44⁴ 50/60Hz Medium, Hi-Inrush
- 46⁴ 50/60Hz Long, Hi-Inrush
- 52⁴ DC Short, Hi-Inrush
- 54⁴ DC Medium, Hi-Inrush
- 56⁴ DC Long, Hi-Inrush

- Notes:
- 1 Push-to-reset actuators have OFF portion of rocker shrouded.
 - 2 Multi-pole breakers have all breakers identical except when specifying Aux. switch and/or mixed poles, and have one rocker per breaker.
 - 3 On multi-pole breakers, one aux. switch is supplied, mounted in the extreme right pole. Available up to 50 amps maximum.
 - 4 Available up to 50 amps maximum.
 - 5 Current ratings 71 - 100 with VDE approvals are available up to two poles maximum.
 - 6 Terminal Code 1 available to 60 amps maximum.
 - 7 Terminal Codes 2, 4, 5 & C available to 50 amps maximum.
 - 8 Terminal Codes 3, 6, 9 & A available to 100 amps maximum.
 - 9 Terminal Codes 8, 9 & C are not VDE approved.
 - 10 Color shown is visi and legend with remainder of rocker black
 - 11 Dual = ON-OFF/I-O legend on actuator.
 - 12 VDE and TUV approval requires Dual (I-O, ON-OFF) markings on rocker.
 - 13 Legend on push-to-reset bezel/shroud is white when single color rocker is ordered. Legend on push-to-reset bezel/shroud matches visi-color of rocker with actuator codes 5 & 6.
 - 14 Recessed "OFF-SIDE" available with actuator codes 1, 2, 3, & 4. Legends on rocker are available in ink stamping only.
 - 15 Barriers supplied on multi-pole units only.
 - 16 2 & 3 pole circuit breakers required for 120/240 AC rating.

7 CURRENT RATING (AMPERES)⁵

CODE	AMPERES				
210	0.100	295	0.950	470	7.000
215	0.150	410	1.000	475	7.500
220	0.200	512	1.250	480	8.000
225	0.250	415	1.500	485	8.500
230	0.300	517	1.750	490	9.000
235	0.350	420	2.000	495	9.500
240	0.400	522	2.250	610	10.000
245	0.450	425	2.500	710	10.500
250	0.500	527	2.750	611	11.000
255	0.550	430	3.000	711	11.500
260	0.600	435	3.500	612	12.000
265	0.650	440	4.000	712	12.500
270	0.700	445	4.500	613	13.000
275	0.750	450	5.000	614	14.000
280	0.800	455	5.500	615	15.000
285	0.850	460	6.000	616	16.000
290	0.900	465	6.500	617	17.000

8 TERMINAL

- 1⁶ Stud 10-32, threaded .625 long
- 2⁷ Screw 10-32 w/saddle & washer clamps
- 3⁸ Stud 1/4-20, threaded .625 long
- 4⁷ Stud M5 x 0.8, threaded .625 long
- 5⁷ Screw M5 x 0.8 w/saddle & washer clamps
- 6⁸ Stud M6, threaded 17mm long
- 8⁹ 1/4" Clip Terminal
- 9^{8,9} 7/16" Clip Terminal
- A^{8,9} Plug-In Stud
- C^{7,9} 5/16" Clip Terminal

9 ACTUATOR COLOR & LEGEND¹²

Actuator or Visi-Color 9	Marking:	Marking Color:
Color:	ON-OFF	Dual¹¹
White	B	1
Black	D	2
Red	G	3
Green	J	4
Blue	L	5
Yellow	N	6
Gray	Q	7
Orange	S	8
		Single Color Rocker/Handle
		Visi-Rocker
		Black
		White
		n/a
		White
		Red
		Green
		White
		Blue
		Black
		Yellow
		Black
		Gray
		Orange

10 MOUNTING/BARRIERS¹²

	Standard Rocker Bezel	BARRIERS ¹⁵
A	6-32 x 0.195 inches	yes
C	ISO M3 x 5mm	yes
	Threaded Insert, 2 per pole	
E	6-32 x 0.195 inches	yes
F	ISO M3 x 5mm	yes
	Recessed Off Rocker¹⁴	
	Threaded Insert, 2 per pole	
B	6-32 x 0.195 inches	yes
D	ISO M3 x 5mm	yes
	Push-To-Reset Bezel	
	Threaded Insert, 2 per pole	

11 MAXIMUM APPLICATION RATING

- A** 65 DC
- B** 125 DC
- C** 120/240 AC¹⁶
- D** 240 AC
- F** 277 AC
- K** 120 AC
- M** 80 DC

12 AGENCY APPROVAL

- A** without approvals
- G** UL 489 Listed & CSA Certified
- J** UL489 Listed, CSA Certified & TUV Certified

DESCRIPTION	CODE	DIMENSIONAL DETAIL	RATING (AMPS)		
			25	50	100
#10-32 STUD	1				
M5 STUD	4				
#1/4-20 STUD	3				
M6 STUD	6				
#1/4-20 STUD	3				
M6 STUD	6				
#10-32 SCREW	2				
M-5 SCREW	5				

DESCRIPTION	CODE	DIMENSIONAL DETAIL	RATING (AMPS)		
			25	50	100
.250 DOUBLE Q.C.	7				
7/16" CLIP TERMINALS	9				
PUSH-IN STUD	A				

NOTES: TOLERANCE ON STUD LENGTHS IS ±.031 [±.79] UNLESS OTHERWISE SPECIFIED.

AUXILIARY / ALARM SWITCH TERMINAL DETAIL³

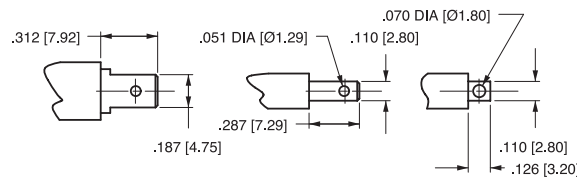

TAB (Q.C.) .187

TAB (Q.C.) .110

SOLDER TYPE

TIGHTENING TORQUE SPECIFICATIONS	
THREAD SIZE	TORQUE
#6-32 [M3] MOUNTING INSERTS	7-9 IN-LBS [0.8-1.0 NM]
#10-32 & M5 THD STUDS	15-20 IN-LBS [1.7-2.3 NM]
#10-32 THD SCREW	15-20 IN-LBS [1.7-2.3 NM]
#1/4-20 & M6 THD STUDS	30-35 IN-LBS [3.4-4.0 NM]

TERMINAL HARDWARE				
TERMINAL DESCRIPTION	CODE	AGENCY APPROVAL	AMPERE RATING	HARDWARE SUPPLIED
#10-32 STUD	1	ALL	.02 - 50	LOCK WASHER - FLAT WASHER - NUT
M5 STUD	4	ALL	.02 - 50	LOCK WASHER - FLAT WASHER - NUT
#1/4-20 STUD	3	ALL	.02 - 80	LOCK WASHER - FLAT WASHER - NUT
			81 - 100	LOCK WASHER - NUT - (2)FLAT WASHER - NUT
M6 STUD	6	ALL	.02 - 80	LOCK WASHER - FLAT WASHER - NUT
			81 - 100	LOCK WASHER - NUT - (2)FLAT WASHER - NUT
#10-32 SCREW	2 & 5	UL RECOGNIZED	.02 - 50	* SADDLE CLAMP - FLAT WASHER - SCREW
		UL-489 LISTED	.02 - 50	LOCK WASHER - FLAT WASHER - SCREW
		TUV & VDE CERTIFIED	.02 - 16	* SADDLE CLAMP - FLAT WASHER - SCREW
		TUV & VDE CERTIFIED	16.1 - 50	LOCK WASHER - FLAT WASHER - SCREW

* THE SADDLE CLAMP IS FOR DIRECT WIRE CONNECTION USE. DISCARD SADDLE CLAMP IF WIRE TERMINAL LUG IS USED

- Notes:
 1 All dimensions are in inches [millimeters].
 2 Tolerance ±.020 [±.51] unless otherwise specified.
 3 Available on Series Trip and Switch Only Circuits when called for on multi-pole units. Only one aux. switch is normally supplied, as viewed in multi-pole identification scheme.

	CIRCUIT SCHEMATIC		CIRCUIT CODE AUX SWITCH CODE	CIRCUIT SCHEMATIC		CIRCUIT CODE AUX SWITCH CODE
	ANSI	IEC		ANSI	IEC	
			LINE O			B C O
	SWITCH ONLY (NO COIL) WITH AUXILIARY SWITCH		LOAD	SERIES TRIP WITH AUXILIARY / ALARM SWITCH		
			A 2 3 4			B C 2 3 4
	SHUNT TRIP			DUAL COIL; SERIES TRIP CURRENT COIL, SHUNT TRIP VOLTAGE COIL		
			D E F 0			H 0
	RELAY TRIP			DUAL COIL; SERIES TRIP CURRENT COIL, RELAY TRIP VOLTAGE COIL		
			F G 0			K 0

HANDLE POSITION VS. AUX/ALARM SWITCH MODE					
CIRCUIT BREAKER MODE	STANDARD C/B		MID TRIP C/B		
	HANDLE POSITION	AUX. SWITCH MODE	HANDLE POSITION	STANDARD ALARM SWITCH MODE	REVERSE ALARM SWITCH MODE ⁴
OFF					
ON					
ELECTRICAL TRIP					

Notes:

- 1 All dimensions are in inches [millimeters].
- 2 Tolerance $\pm .020$ [.51] unless otherwise specified.
- 3 Schematic shown represents current trip circuits.
- 4 Available only as special catalog number.

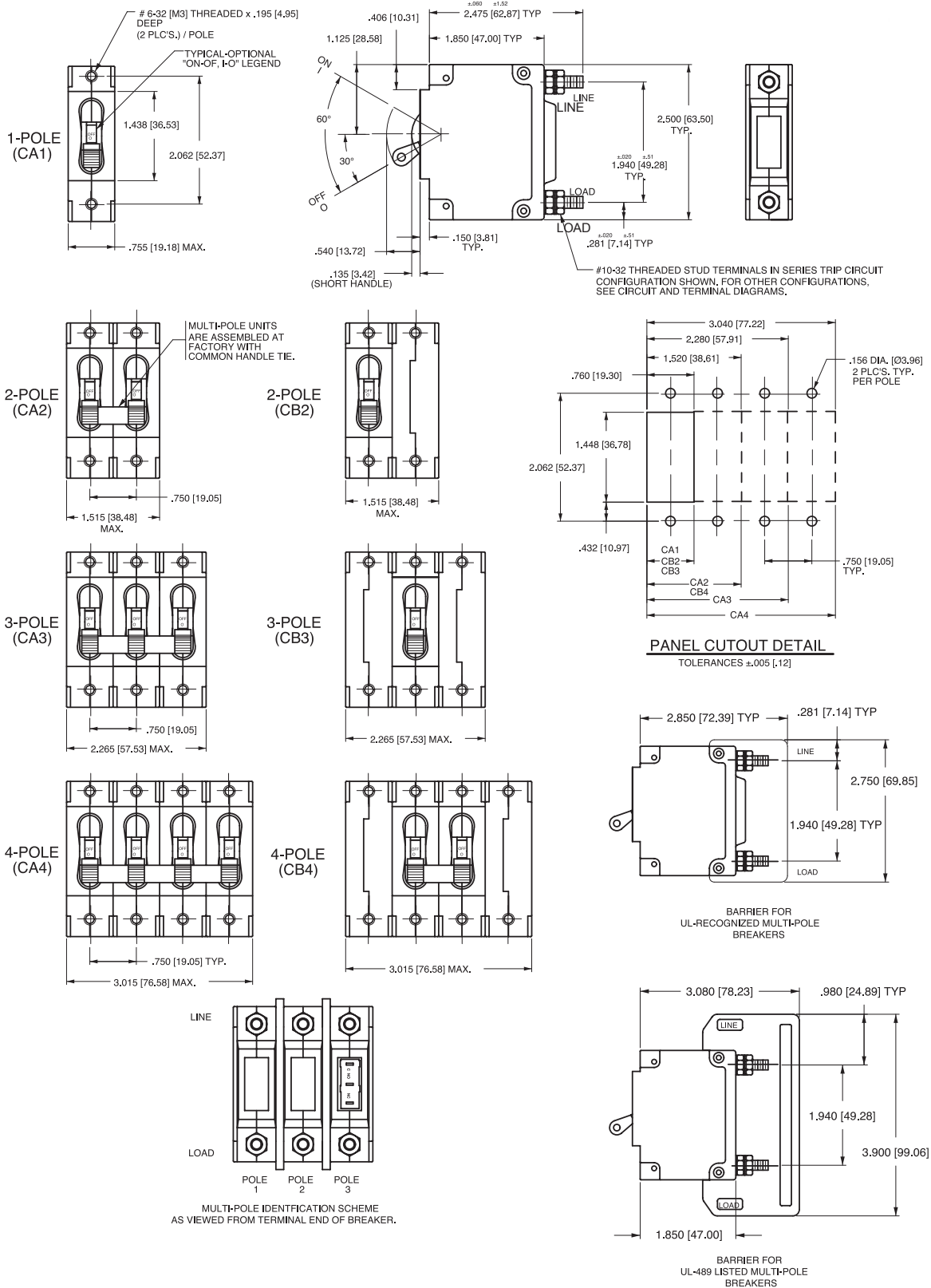

Notes:
1 All dimensions are in inches [millimeters].
2 Tolerance ±.020 [.51] unless otherwise specified.

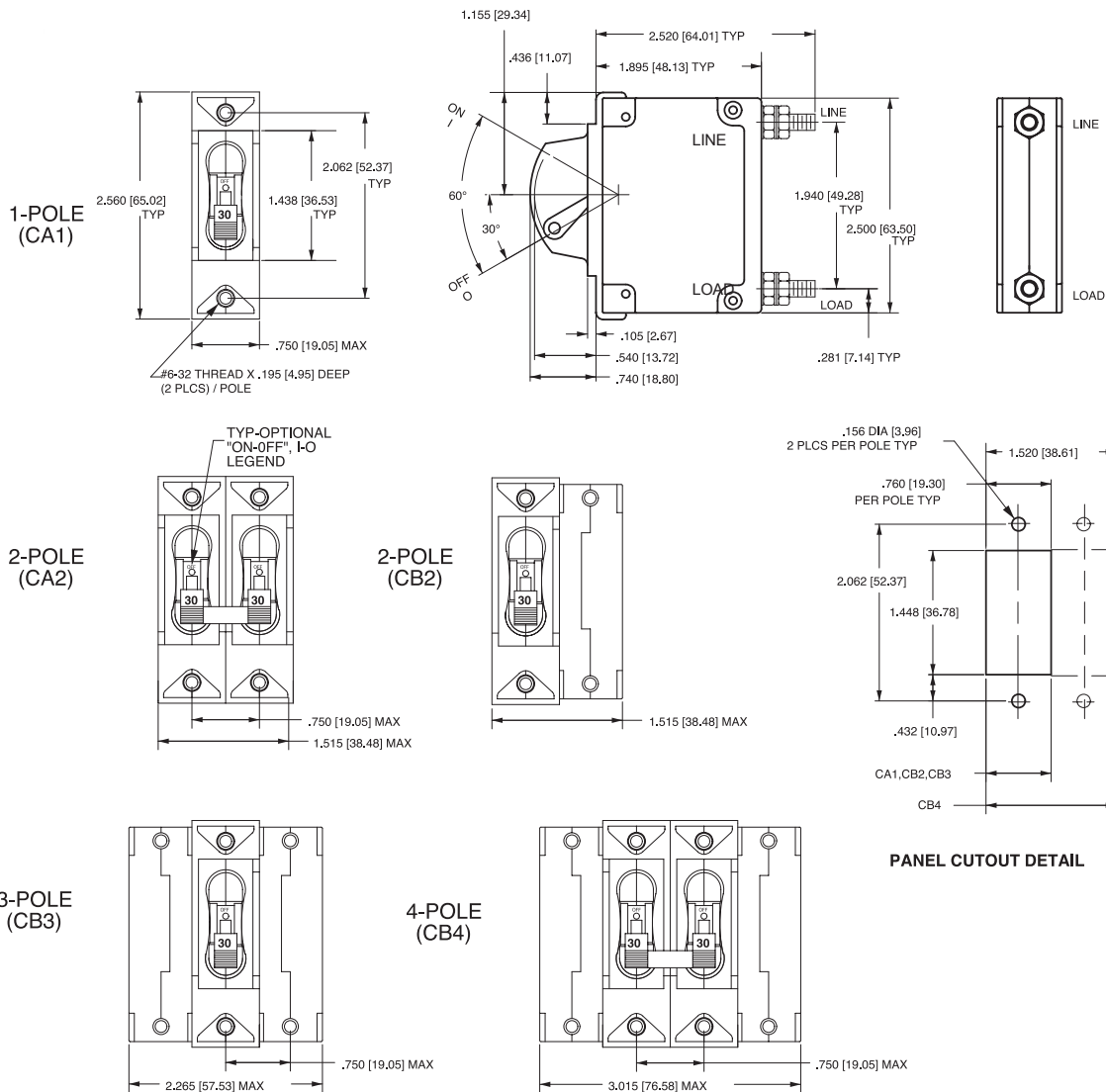

*Handguard available as special catalog number only

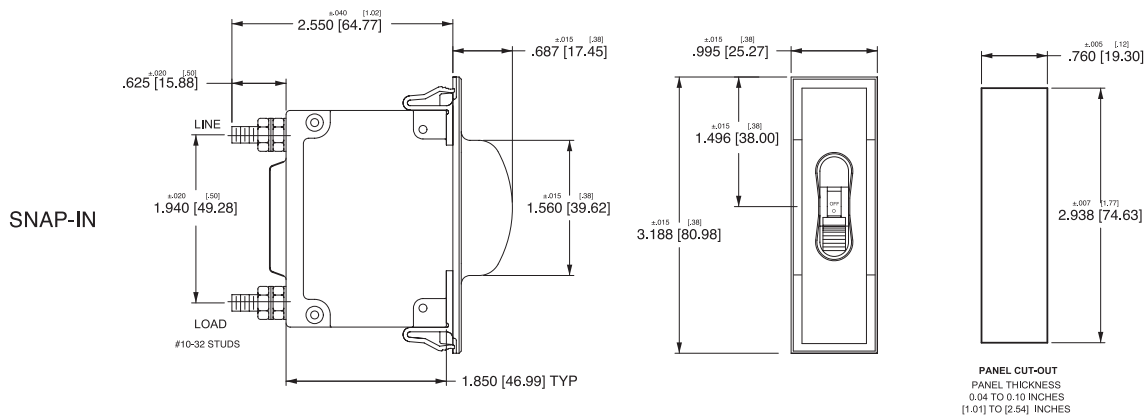

- Notes:
 1 All dimensions are in inches [millimeters].
 2 Tolerance ± 0.020 [.51] unless otherwise specified.

PARALLEL POLE (CA2-P)

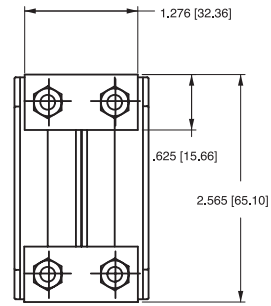
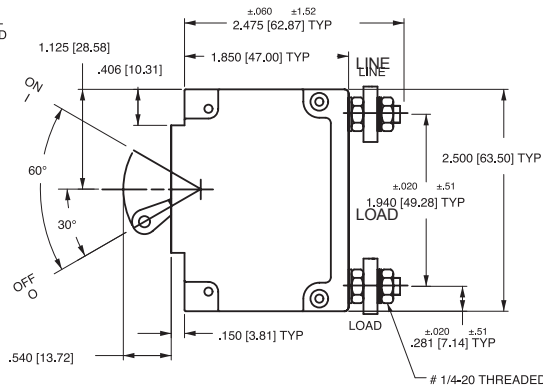
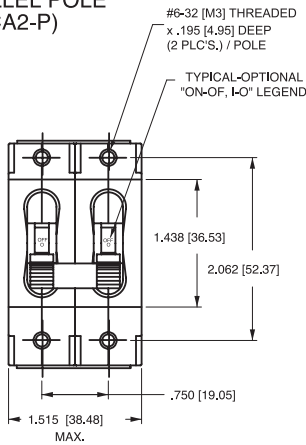

PARALLEL POLE (CA3-P)

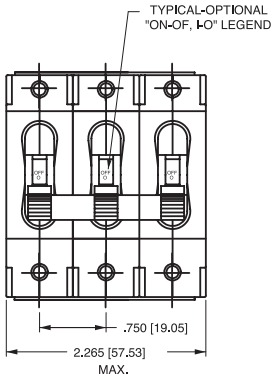

CIRCUIT BREAKER PROFILE	CIRCUIT SCHEMATIC (CA2-P SHOWN)		CIRCUIT CODE	AUX SWITCH CODE
	ANSI	IEC		
	SERIES TRIP 		P	0
	SERIES TRIP WITH AUXILIARY SWITCH 		P	2 3 4

TERMINAL DETAILS

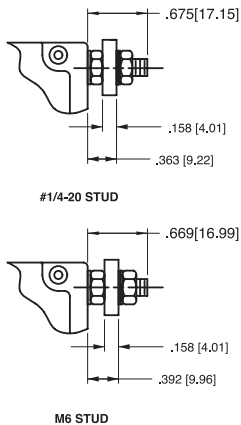
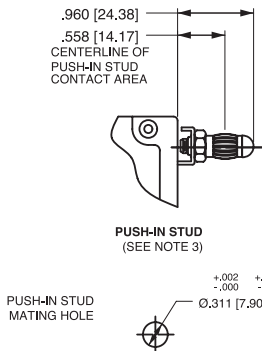

PANEL CUTOUT DETAIL

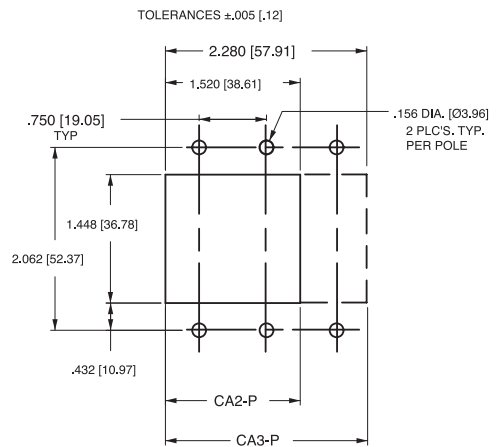

- Notes:
- 1 All dimensions are in inches [millimeters].
 - 2 Tolerance ± 0.020 [.51] unless otherwise specified.

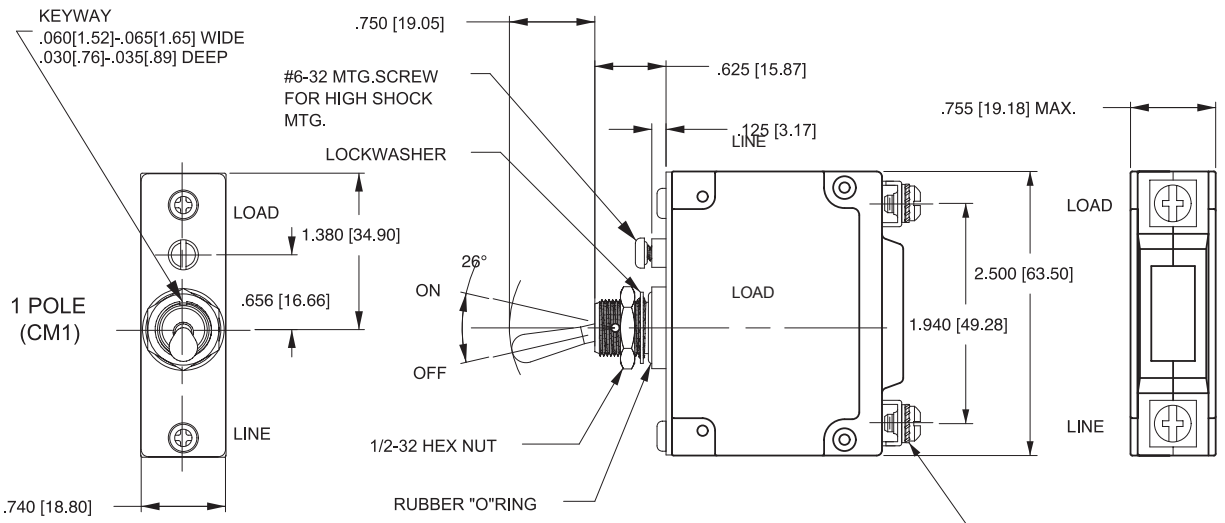

SCREW TYPE TERMINALS
 IN SERIES TRIP CIRCUIT
 CONFIGURATION SHOWN.
 FOR OTHER CONFIGURATIONS
 SEE CIRCUIT & TERMINAL
 DIAGRAMS

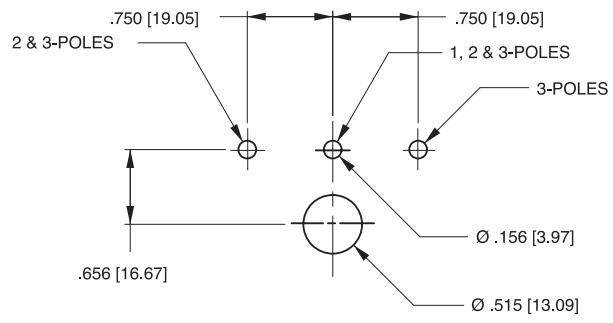
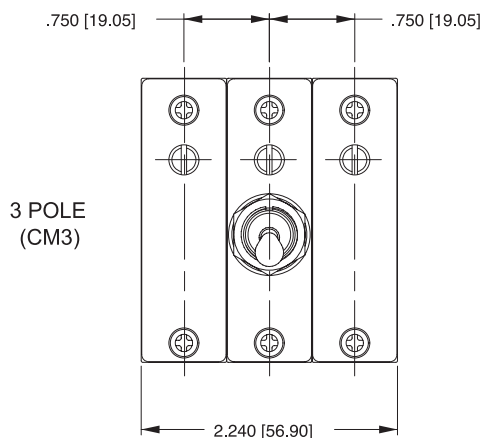
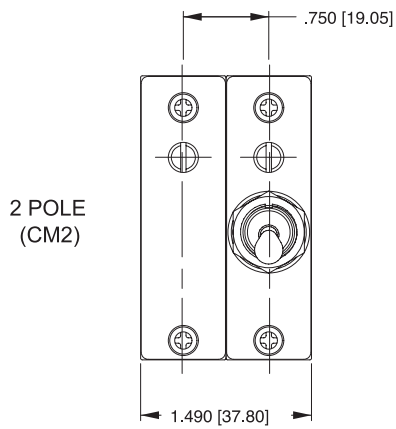

PANEL CUTOUT DETAIL
 TOLERANCES ±.005[.13]

- Notes:
- 1 All dimensions are in inches [millimeters].
 - 2 Tolerance ±.020 [.51] unless otherwise specified.

CIRCUIT BREAKER PROFILE	CIRCUIT SCHEMATIC		CIRCUIT CODE	AUX. SWITCH CODE	CIRCUIT SCHEMATIC		CIRCUIT CODE	AUX. SWITCH CODE
	ANSI	IEC			ANSI	IEC		
<p>SERIES TRIP (2 TERM.S.)</p>			LINE	0			BC	0
<p>SERIES TRIP W/AUX. SWITCH (5 TERM.S.)</p>			LOAD	2 3 4			BC	2 3 4
<p>SHUNT TRIP (3 TERM.S.)</p>			LINE	0			H	0
<p>SHUNT TRIP (4 TERM.S.)</p>			RELAY	0			K	0

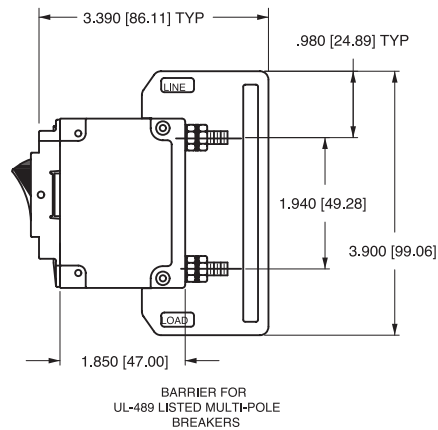
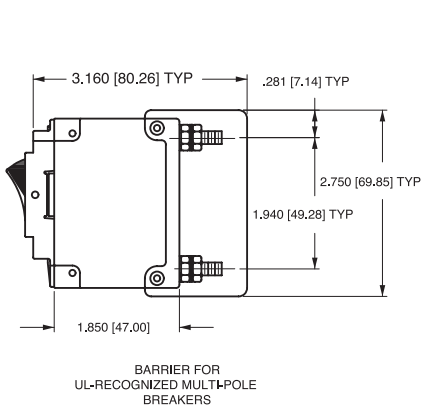

- Notes:
- 1 All dimensions are in inches [millimeters].
 - 2 Tolerance ± 0.020 [.51] unless otherwise specified.
 - 3 Schematic shown represents current trip circuit.

INDICATE "ON"

SCREW TYPE TERMINALS IN SERIES TRIP CIRCUIT CONFIGURATION SHOWN, FOR OTHER CONFIGURATIONS SEE CIRCUIT AND TERMINAL DIAGRAMS.

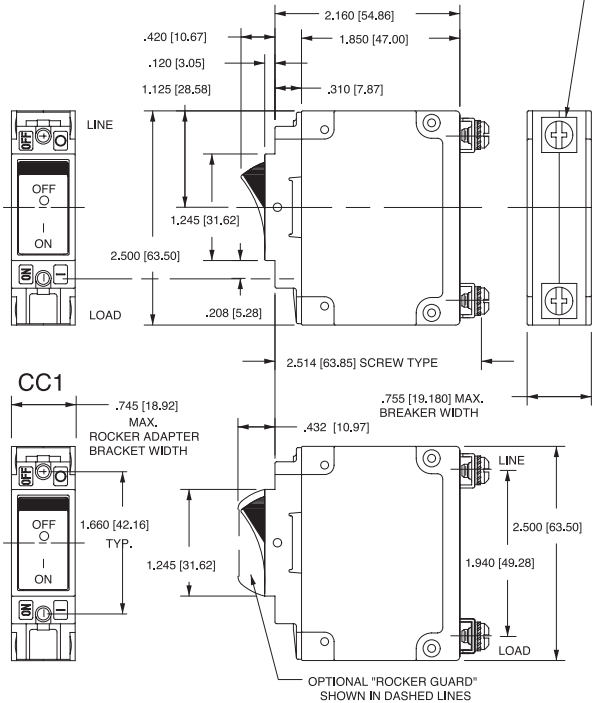

INDICATE "OFF" & SINGLE COLOR

(INDICATE "OFF" SHOWN)

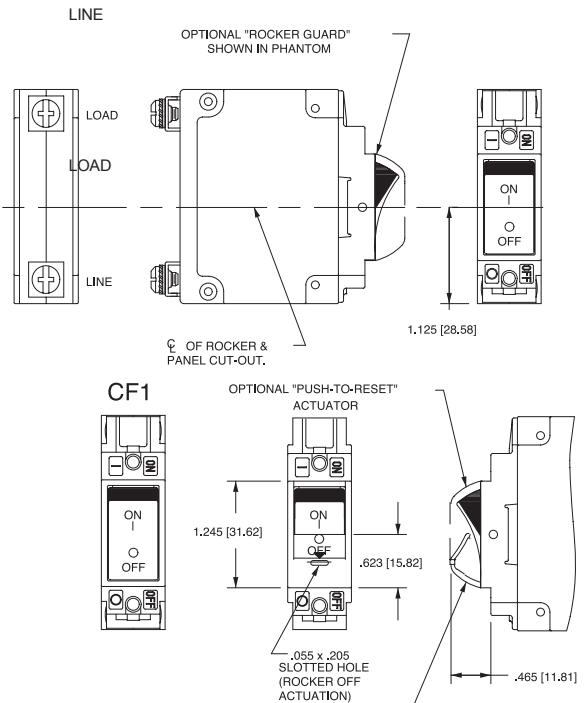

CC1

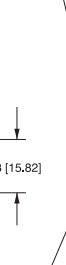
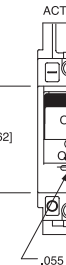
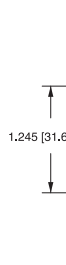
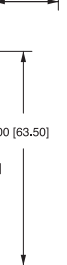
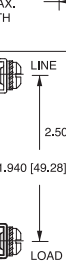
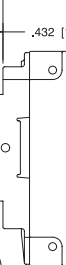
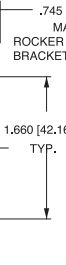

CC2

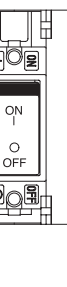
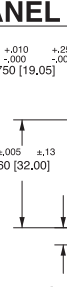
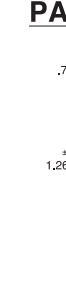

PANEL CUT-OUT DETAIL

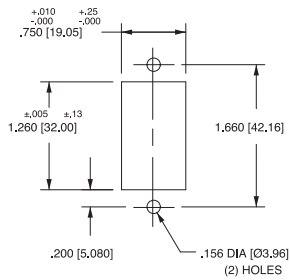

CC3

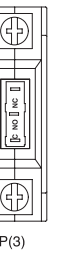
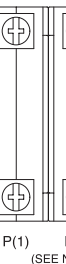
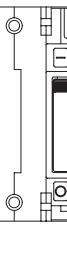
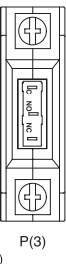
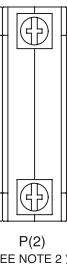
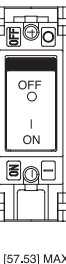

REAR VIEW OF INDICATE "ON" SERIES TRIP W/ AUX SWITCH CIRCUIT CONFIGURATION.

CF3

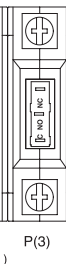
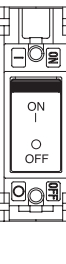

REAR VIEW OF INDICATE "OFF" SERIES TRIP W/ AUX SWITCH CIRCUIT CONFIGURATION.

Notes:

- 1 Dimensions apply to all variations shown. Notice that circuit breaker line and load terminal orientation on indicate OFF is opposite of indicate ON.
- 2 For pole orientation with horizontal legend, rotate front view clockwise 90°.
- 3 All dimensions are in inches [millimeters].
- 4 Tolerance ±.020 [.51] unless otherwise specified.

INDICATE "OFF" & SINGLE COLOR

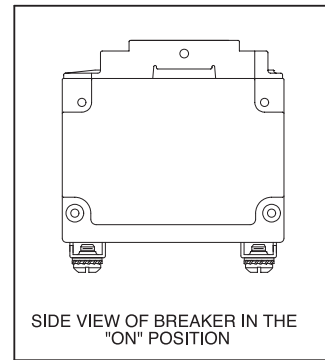
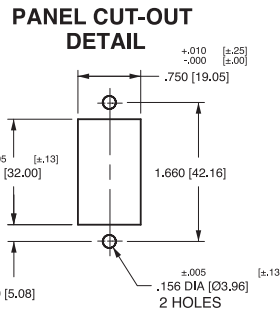
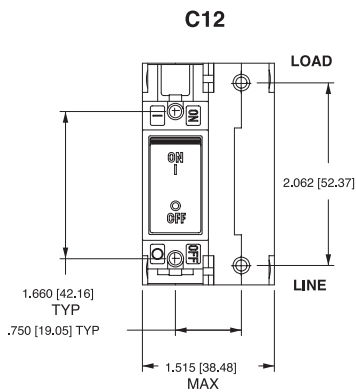
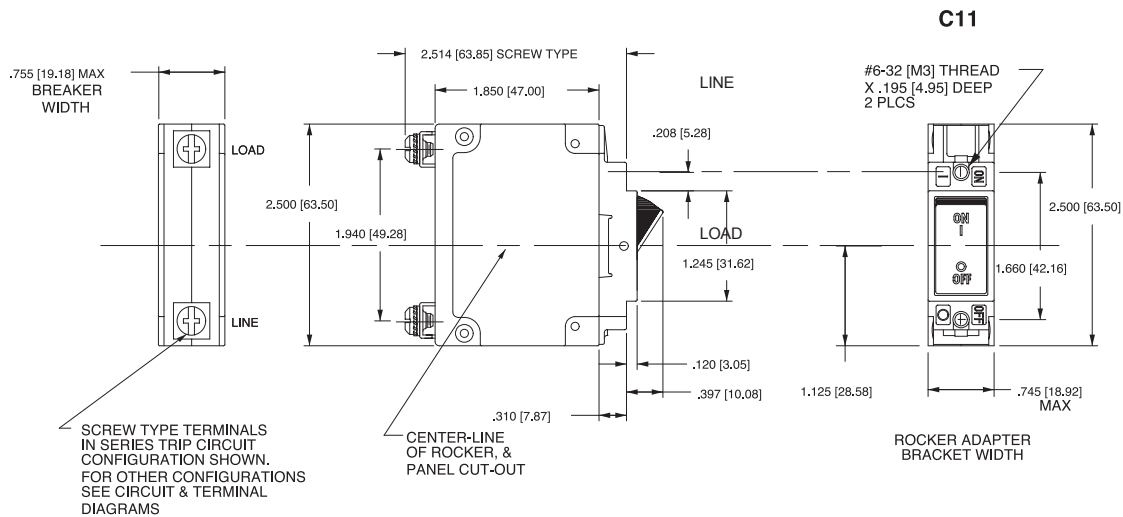

PUSH-TO-RESET ACTUATOR

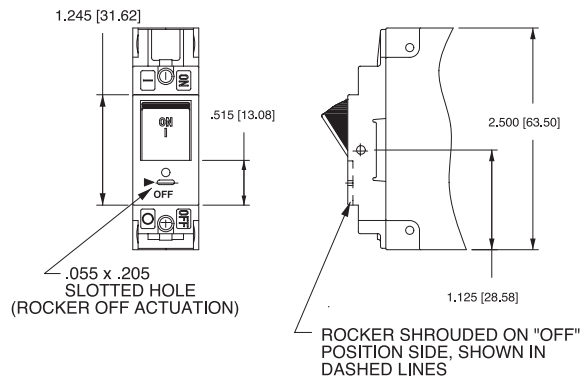
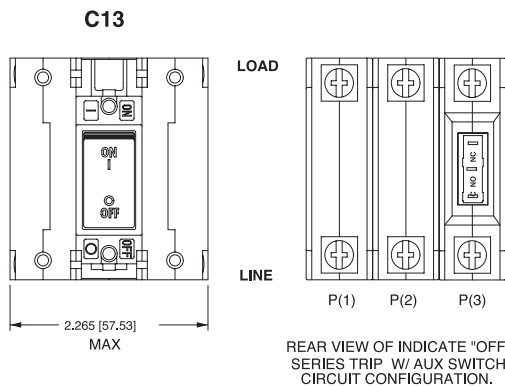

ACTUATOR SIDE VIEW (SURFACE CONTOURS)

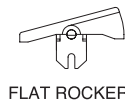

- Notes:
- 1 For pole orientation with horizontal legend, rotate front view clockwise 90°.
 - 2 All dimensions are in inches [millimeters].
 - 3 Tolerance $\pm .020$ [.51] unless otherwise specified.

Worldwide Headquarters

Carling Technologies, Inc.
60 Johnson Avenue • Plainville, CT 06062
Phone: (860) 793-9281 • Fax: (860) 793-9231
Email: sales@carlingtech.com • www.carlingtech.com

East Region Sales Office, CT • ersm@carlingtech.com
Midwest Region Sales Office, IL • mrsm@carlingtech.com
West Region Sales Office, CA • wrsm@carlingtech.com

Asia-Pacific Headquarters

Carling Technologies, Asia-Pacific Ltd.,
Kowloon, Hong Kong
Int + 852-2737-2277 • Fax: Int + 852-2736-9332
Email: sales@carlingtech.com.hk

Shenzhen, China • shenzhen@carlingtech.com
Shanghai, China • shanghai@carlingtech.com
Pune, India • india@carlingtech.com
Kaohsiung, Taiwan • taiwan@carlingtech.com
Yokohama, Japan • japan@carlingtech.com

Europe / Middle East / Africa Headquarters

Carling Technologies, Ltd.,
Devon, England
Int + 44 1392-364422 • Fax: Int + 44 1392-364477
Email: ltd.sales@carlingtech.com

GmbH, Germany • gmbh@carlingtech.com
SAS, France • sas@carlingtech.com

REV_CB_C_04_2013



Carling Technologies®

Innovative Designs. Powerful Solutions.

INNOVATIVE DESIGNS. POWERFUL SOLUTIONS.