

At ICC Intervox, Great values always sound good

Typical Applications



Security



Computers/Instrumentation



Medical Electronics



Telecommunications



Consumer Electronics



GPS/Hand Helds

Intervox audible devices from International Components Corporation (ICC) provide ideal solutions for a wide variety of applications, including computers and peripherals, electronic devices, security systems, medical instruments, wireless communications and other high tech applications.

Manufactured to ISO 9002 standards, ICC Intervox products offer highly customized solutions, including required output frequency, sound output (SPL), voltage range, power consumption, tone type, mounting and termination, availability and cost.

Within this catalog you'll find hundreds of products, complete with enough technical information for design engineers to specify products without looking elsewhere. However, should you have a unique requirement, ICC Intervox can customize a product to suit your needs.



Looking for sound values? ICC Intervox hears you loud and clear. If the product you need cannot be found in this catalog, or if you require additional technical support, call ICC today at 1-800-645-9154 or visit our website: www.icc107.com



Audible Devices

- Surface Mount Electro-Acoustic Transducers [5](#)
- Electro-Acoustic Transducers [6-8](#)
- Surface Mount Piezo Buzzers [8](#)
- Piezo Electric Alarms - External Drive [9-10](#)
- Piezo Buzzers - External Drive, Dual Control [10](#)
- Piezo Buzzers - Self-Drive [11-12](#)
- Piezo Electric Alarms w/Internal Circuitry [12-16](#)
- Volume Control for Panel Mount Series BRP4535 and BRP4549 [16](#)
- Piezo Sounders w/Built-In Circuit [17-18](#)
- Melody Buzzers [19](#)
- Electronic Chimes [19](#)
- Piezo Speakers for Musical Cards [19](#)
- Piezo Ultrasonic Transducer [19](#)
- Piezo Telephone Ringers - External Drive [20](#)
- 3-Tone Piezo Telephone Ringer [20](#)
- Piezo Sounders External-Drive Type [20](#)
- AC Piezo Buzzers [21](#)
- Electronic AC Buzzer [21](#)
- Electronic DC Buzzer [22](#)
- Piezo Elements [23-24](#)

Speakers

- General Purpose Speakers [26](#)
- Telecommunications Speakers [26-27](#)
- Shielded Low Leakage Speakers [27-28](#)
- Micro Miniature Low Profile Speakers [28-29](#)
- Sub-Miniature Low Profile Speakers [29-30](#)
- PC Mount Speakers [31](#)
- Surface Mount Speakers [31](#)

Microphones

- Electret Condenser Microphones
 - Omnidirectional [33](#)
 - Unidirectional [33](#)
 - Noise Cancelling [33](#)
 - Without Fet Impedance Converter [34](#)
- Rubber Grommets [34](#)
- Plastic PC Mount Holders [34](#)

At ICC Intervox, Great values always sound good

Typical Applications



Security



Computers/Instrumentation



Medical Electronics



Telecommunications



Consumer Electronics



GPS/Hand Helds

Intervox audible devices from International Components Corporation (ICC) provide ideal solutions for a wide variety of applications, including computers and peripherals, electronic devices, security systems, medical instruments, wireless communications and other high tech applications.

Manufactured to ISO 9002 standards, ICC Intervox products offer highly customized solutions, including required output frequency, sound output (SPL), voltage range, power consumption, tone type, mounting and termination, availability and cost.

Within this catalog you'll find hundreds of products, complete with enough technical information for design engineers to specify products without looking elsewhere. However, should you have a unique requirement, ICC Intervox can customize a product to suit your needs.



Looking for sound values? ICC Intervox hears you loud and clear. If the product you need cannot be found in this catalog, or if you require additional technical support, call ICC today at 1-800-645-9154 or visit our website: www.icc107.com

ICC Intervox offers customized solutions

ICC Intervox audible devices are designed to deliver peak performance for a variety of demanding applications. In addition to offering the product as shown within this catalog, ICC Intervox can assist you with the following services:

- Cable assemblies
- Connectors
- Spring contacts for solderless connections
- SMT pick-and-place packaging
- Bar coding
- Private labeling, and more...

At ICC, we're focused on increasing the efficiency of your production with standard or customized products.



INTERVOX[®]
A Division of International Components Corp.

Audible Devices

Surface Mount Electro-Acoustic Transducers 5

Miscellaneous Piezo Products 19-20

Electro-Acoustic Transducers 6-8

Electronic Buzzers 21-22

Piezo Buzzers 8-16

Piezo Elements 23-24

Piezo Electric Sounders 17-18

Top quality, exceptional value

Carefully constructed using highest quality materials, Intervox offers a wide range of buzzers, transducers, piezo alarms and sounders - an almost unlimited selection of functions, tones, sizes, and mounting styles. All our audible devices provide clear, rich sound and long life durability to withstand the most severe environments. For dependability and long life, choose Intervox.

Electro-Acoustic Transducers



Intervox magnetic transducers were designed to fulfill limited space requirements using lower frequency tones than traditional piezo devices. We offer a variety of sizes, shapes and terminations for specific applications.

Surface Mount Buzzers



Intervox has designed a series to meet the growing demand for surface mounting of components. Available in both magnetic and piezo technologies, most are external drive types but several are available with built-in circuits. While they are smaller in size, the SPL output is not at all compromised. Packaging styles include auto insertion tubes and tape and reel.

Piezo Buzzers



The Intervox Piezo Electric was created to provide the ultimate in buzzer science while drawing lower current than other technologies. Distinctive in virtually any environment, these buzzers feature a level of reliability, efficiency and clear, penetrating sound quality that is second to none.

Piezo Elements



When design demands extremely low profile devices, Intervox offers a distinct selection of piezo elements to meet virtually any application. The line includes standard external drive elements, types with feedback electrode, and double sided ceramic types. Intervox is also prepared to customize our elements by adding wires and connectors when necessary.

Piezo Electric Sounders



Intervox's very high SPL output piezo electric sounders (100dB or greater @ 1 meter) require low power, yet produce clear, powerful sound. They're designed for a variety of applications with a liberal selection of tones and mountings.

Electronic Buzzers



Intervox solid-state electronic buzzers are designed for applications requiring low frequency of 400Hz. They are simple, rugged and low cost. Considering these advantages, they still produce a rich, broad sound consistent with a wide variety of requirements. There are no mechanical points to arc or require maintenance and RF noise is non-existent.

Electro Acoustic Transducers

Surface Mount Electro-Acoustic Transducers

Part Number	Rated Voltage (VDC)	Operating Voltage (VDC)	Max. Current (mA)*	Coil Resistance (Ohms)	SPL Output (dB) @10CM (Min.)*	Resonant Frequency (Hz)*	Operating Temperature
BST0803SM-03	3.6	2.5 - 4.5	100	16 ± 3	85dB min (typ 91)	2730Hz	-30° to +70°C
BST0803SM-05	5	4 - 6	90	32 ± 3	85dB min (typ 91)	2730Hz	-30° to +70°C
BST0803SM-03-4T	3.6	2.5 - 4.5	100	16 ± 3	85dB min (typ 91)	2730Hz	-30° to +70°C
BST0803SM-05-4T	5	4 - 6	90	32 ± 3	85dB min (typ 91)	2730Hz	-30° to +70°C
BST0804SM-03	3.6	2.5 - 4.5	100	16 ± 3	87dB min (typ 92)	2730Hz	-30° to +70°C
BST0804SM-05	5	4 - 6	90	32 ± 3	87dB min (typ 92)	2730Hz	-30° to +70°C
BST0804SM-03-4T	3.6	2.5 - 4.5	100	16 ± 3	87dB min (typ 92)	2730Hz	-30° to +70°C
BST0804SM-05-4T	5	4 - 6	90	32 ± 3	87dB min (typ 92)	2730Hz	-30° to +70°C
BRT0903SM-01-GW	1.5	1.2 - 1.7	90	6 ± 1	85dB min (typ 90)	2731Hz	-20° to +60°C
BRT0903SM-03-GW	3.6	2.5 - 4.5	90	16 ± 3	87dB min (typ 95)	2731Hz	-20° to +60°C
BRT0903SM-05-GW	5	4 - 6	70	32 ± 5	87dB min (typ 95)	2731Hz	-20° to +60°C
BRT0904SM-01-GW	1.5	1.2 - 1.7	90	6 ± 1	85dB min (typ 90)	2731Hz	-20° to +60°C
BRT0904SM-03-GW	3.6	2.5 - 4.5	100	16 ± 3	87dB min (typ 95)	2731Hz	-20° to +60°C
BRT0904SM-05-GW	5	4 - 6	70	32 ± 5	87dB min (typ 95)	2731Hz	-20° to +60°C
BST0904SM-03-4T	3.6	2.5 - 4.5	100	16 ± 3	85dB min (typ 95)	2670Hz	-30° to +70°C
BST0905SM-03	3.6	2.5 - 4.5	100	16 ± 3	85dB min (typ 95)	2670Hz	-30° to +70°C
BST1003SM-03A	3.6	2 - 4.5	90	16 ± 3	85dB min (typ 91)	2700Hz	-20° to +60°C
BST1003SM-03B	3.6	2 - 4.5	90	16 ± 3	85dB min (typ 91)	3000Hz	-20° to +60°C
BST1206SM-01-GW	1.5	1 - 2	30	15 ± 7.5	70dB min	2048Hz	-40° to +70°C
BST1307SM-01	1.5	1 - 2	40	15 ± 3	85dB min	2400Hz	-20° to +70°C
BST1307SM-05	5	4 - 7	40	45 ± 5	85dB min	2400Hz	-20° to +70°C
BST1307SM-12	12	8 - 16	40	140 ± 14	85dB min	2400Hz	-20° to +70°C
BST1310SM-01	1.5	1 - 2	40	15 ± 3	85dB min	2400Hz	-20° to +70°C
BST1310SM-05	5	4 - 7	40	45 ± 5	85dB min	2400Hz	-20° to +70°C
BST1310SM-12	12	8 - 16	40	140 ± 14	85dB min	2400Hz	-20° to +70°C
BST1310SM-01-C	1.5	1.4 - 3	20	not applicable w/built-in circuit	75dB min	2400 ± 400Hz	-20° to +70°C
BST1310SM-05-C	5	3 - 7	30		90dB min	2400 ± 300Hz	-20° to +70°C
BST1310SM-12-C	12	8 - 16	30		90dB min	2400 ± 300Hz	-20° to +70°C
BST1403SM-01	1.5	1.2 - 1.7	80	9 ± 2	85dB min (typ 92)	3200Hz	-20° to +70°C
BST1403SM-03	3	3 - 4.5	90	18 ± 2	85dB min (typ 92)	3200Hz	-20° to +70°C
BST1403SM-05	5	4 - 6	70	43 ± 3	85dB min (typ 92)	3200Hz	-20° to +70°C

*Value Applying Resonant Frequency (1/2 Duty, Square Wave)

BST0803SM Series

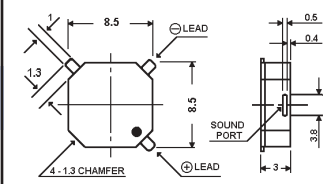

BST0804SM Series

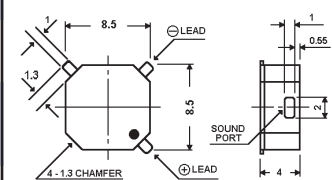

BST0804SM-4T Series

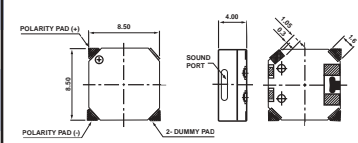

BST0904SM-GW Series

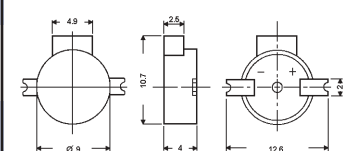

BST1003SM Series

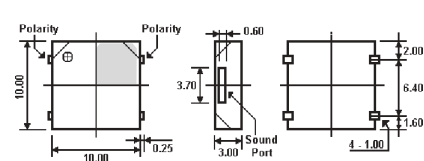

BST0803SM-4T Series

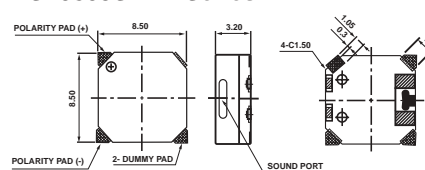

BST0905SM-03 Series

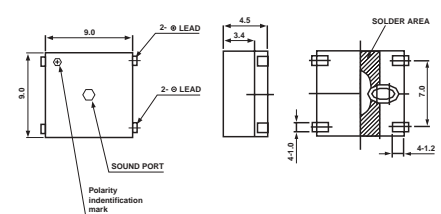

BRT0903SM-GW Series

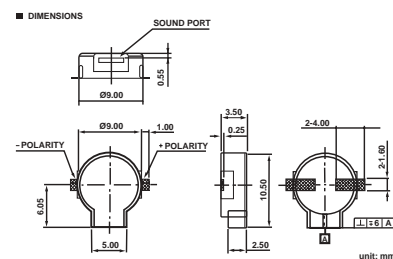

BST0904SM-03-4T Series

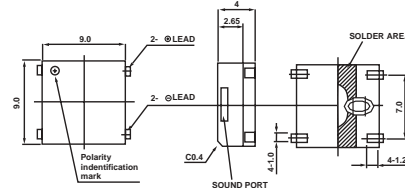

BST1307SM Series

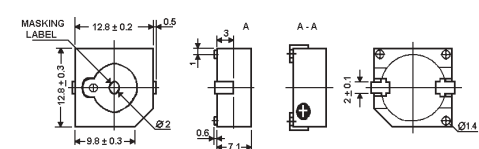

BST1206SM Series

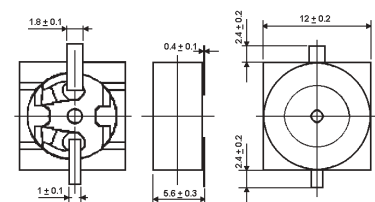

BST1310SM/BST1310SM-C Series

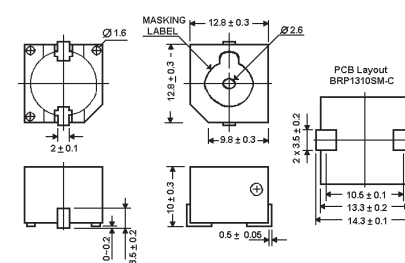

BST1403SM Series

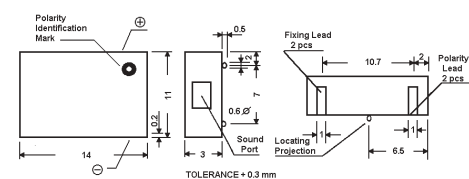

Electro-Acoustic Transducers

Part Number	Rated Voltage (VDC)	Operating Voltage (VDC)	Max. Current (mA)*	Sound Output*	Coil Resistance (Ohms)	Coil Impedance (Ohms)**	Terminal Type	Frequency	Operating Temperature
BRT0905P-03	3	2 - 6	80	82dB @ 10cm	25 ± 4	45	2 Pins	2731Hz	-25° to +70°C
BRT0905P-01-SEHA	1.5	1 - 2	80	90dB @ 10cm	5.5 ± 1	9.5 ± 3	2 Pins	3200Hz	-20° to +60°C
BRT0905P-01-SEHB	1.5	1 - 2	80	85dB @ 10cm	5.5 ± 1	9.5 ± 3	2 Pins	2700Hz	-20° to +60°C
BRT0907P-01	1.5	1 - 2	80	80dB @ 10cm	5.5 ± 1	9.5 ± 3	2 Pins	3100Hz	-20° to +60°C
BRT0907P-01-SEHA	1.5	0.8 - 1.5	80	85dB @ 10cm	5.5 ± 1	9.5 ± 3	2 Pins	3100Hz	-20° to +60°C
BRT0907P-01-SEHB	1.5	1 - 2	80	85dB @ 10cm	5.5 ± 1	9.5 ± 3	2 Pins	2731Hz	-20° to +60°C
BRT1004P-01	1.5	1 - 2	80	85dB @ 10cm	5.5 ± 2	9.5 ± 3	2 Pins	2730Hz	-20° to +60°C
BRT1004P-03	3	2 - 4	60	85dB @ 10cm	25 ± 3	45	2 Pins	2730Hz	-20° to +60°C
BRT1004P-05	5	4 - 6	60	85dB @ 10cm	45 ± 4	80	2 Pins	2730Hz	-20° to +60°C
BRT1206P-01	1.5	1 - 2	10	70dB @ 10cm	50 ± 7.5	140	2 Pins	2048Hz	-20° to +60°C
BRT1207P-01-C	1.5	1.4 - 2	25	75dB @ 10cm	N/A	N/A	2 Pins	2300 ± 500Hz	-20° to +70°C
BRT1207P-03-C	3	2 - 5	30	82dB @ 10cm	W/Built-in	W/Built-in	2 Pins	2300 ± 400Hz	-20° to +70°C
BRT1207P-06-C	5	3 - 7	30	83dB @ 10cm	Drive Circuit	Drive Circuit	2 Pins	2300 ± 400Hz	-20° to +70°C
BRT1207P-12-C	12	9 - 15	30	83dB @ 10cm			2 Pins	2300 ± 400Hz	-20° to +70°C
BRT1207P-01-SEHA	1.5	1 - 2	70	80dB @ 10cm	6.5 ± 1	16	2 Pins	2048Hz	-20° to +60°C
BRT1207P-01-SEHB	1.5	1 - 2	70	75dB @ 10cm	6.5 ± 1	22	2 Pins	2731Hz	-20° to +60°C
BRT1207P-01-SEHC	1.5	1 - 2	10	70dB @ 10cm	50 ± 7.5	140	2 Pins	2048Hz	-20° to +60°C
BRT1209L-01	1.5	1 - 2	30	80dB @ 10cm	16 ± 4	40	2 Leadwires	2048Hz	-20° to +60°C
BRT1209P-01	1.5	1 - 2	30	80dB @ 10cm	16 ± 4	40	2 Pins	2048Hz	-20° to +60°C
BRT1209L-01-50	1.5	1 - 2	10	80dB @ 10cm	50 ± 7.5	140	2 Leadwires	2048Hz	-20° to +60°C
BRT1209P-01-50	1.5	1 - 2	10	80dB @ 10cm	50 ± 7.5	140	2 Pins	2048Hz	-20° to +60°C
BRT1209L-03	3.6	1.5 - 5	70	90dB @ 10cm	16 ± 4	40	2 Leadwires	2048Hz	-20° to +60°C
BRT1209P-03	3.6	1.5 - 5	70	90dB @ 10cm	16 ± 4	40	2 Pins	2048Hz	-20° to +60°C
BRT1209L-03-50	3.6	1.5 - 5	40	86dB @ 10cm	50 ± 7.5	140	2 Leadwires	2048Hz	-20° to +60°C
BRT1209P-03-50	3.6	1.5 - 5	40	86dB @ 10cm	50 ± 7.5	140	2 Pins	2048Hz	-20° to +60°C
BRT1209L-05-50	5	1.5 - 5	50	90dB @ 10cm	50 ± 7.5	140	2 Leadwires	2048Hz	-20° to +60°C
BRT1209P-05-50	5	1.5 - 5	50	90dB @ 10cm	50 ± 7.5	140	2 Pins	2048Hz	-20° to +60°C

*Value Applying Rated Voltage (Resonant Frequency, 1/2 Duty Square Wave)

**Value Applying (Resonant Frequency, Sine Wave, Measuring Current 60uA)

BRT0905P-03 Series

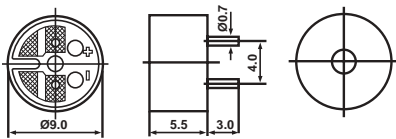

BRT0905P-01-SEH Series

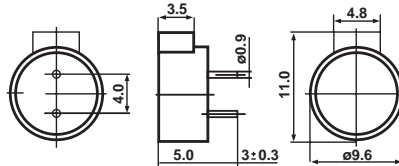

BRT0907P-01 Series

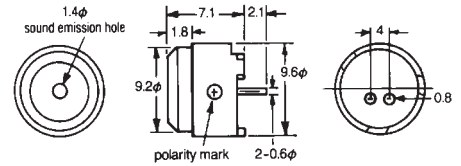

BRT0907P-01-SEH Series

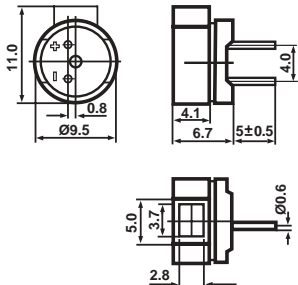

BRT1004P Series

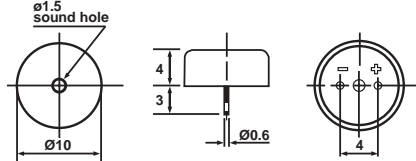

BRT1206P-01 Series

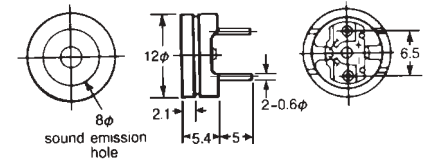

BRT1207P-C Series

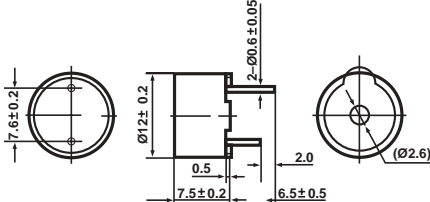

BRT1207P-SEH Series

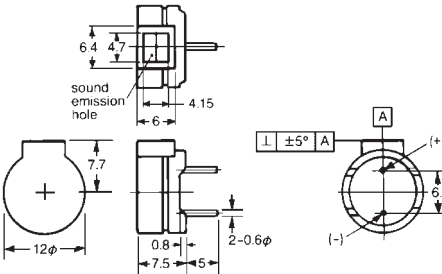

BRT1209 Series

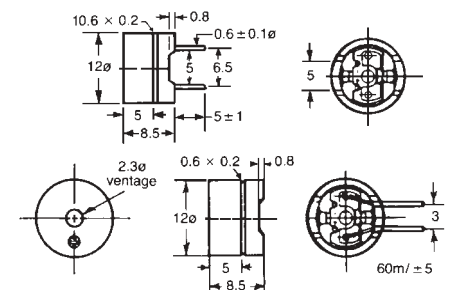

Electro-Acoustic Transducers

Part Number	Rated Voltage (VDC)	Operating Voltage (VDC)	Max. Current (mA)*	Sound Output*	Coil Resistance (Ohms)	Coil Impedance (Ohms)**	Terminal Type	Frequency	Operating Temperature
BRT1209PF-01	1.5	1 - 3	40	75dB @ 10cm	6.5 ± 1	16	2 Pins	2400Hz	-40° to +85°C
BRT1209PF-06	5	4 - 8	40	85dB @ 10cm	4.5 ± 5	80	2 Pins	2400Hz	-40° to +85°C
BRT1209PF-12	12	7 - 15	40	85dB @ 10cm	140 ± 14	240	2 Pins	2400Hz	-40° to +85°C
BRT1209PF-05-RA	5	4 - 8	40	85dB @ 10cm	45 ± 5	80	2 Pins	2400Hz	-40° to +85°C
BRT1209P-01-C	1.5	1.2 - 3	30	70dB @ 10cm	Not Applicable for Types With Built in Drive Circuit		2 Pins	2500Hz	-20° to +70°C
BRT1209P-06-C	5	4 - 8	30	80dB @ 10cm			2 Pins	2300Hz	-20° to +70°C
BRT1209P-12-C	12	7 - 15	30	80dB @ 10cm			2 Pins	2300Hz	-20° to +70°C
BRT1213P-01	1.5	1 - 2	30	80dB @ 10cm	16 ± 4	40	2 Pins	2048Hz	-20° to +60°C
BRT1612P-12	12	6 - 15	50	85dB @ 10cm	135 ± 20	210	2 Pins	1700-2200Hz	-40° to +90°C
BRT1615P-01	1.5	1 - 3	12	80dB @ 10cm	27 ± 3	80	2 Pins	2048Hz	-20° to +70°C
BRT1615P-06	6	3 - 12	40	85dB @ 10cm	50 ± 5	110	2 Pins	2048Hz	-20° to +70°C
BRT1615P-12	12	6 - 18	40	85dB @ 10cm	115 ± 12	200	2 Pins	2048Hz	-20° to +70°C
BRT1615P-01-C	1.5	1.2 - 2	20	75dB @ 10cm	Not Applicable for Types With Built in Drive Circuit		2 Pins	2300Hz	-20° to +70°C
BRT1615P-06-C	6	4 - 7	30	85dB @ 10cm			2 Pins	2200Hz	-20° to +70°C
BRT1615P-12-C	12	8 - 16	30	85dB @ 10cm			2 Pins	2200Hz	-20° to +70°C
BRT1623P-01	1.5	1 - 3	12	80dB @ 10cm	27 ± 3	80	2 Pins	2048Hz	-20° to +70°C
BRT1623P-06	6	3 - 12	40	85dB @ 10cm	50 ± 5	110	2 Pins	2048Hz	-20° to +70°C
BRT1623P-12	12	6 - 18	40	85dB @ 10cm	115 ± 12	200	2 Pins	2048Hz	-20° to +70°C
BST1811P-01	1.5	1 - 2	40	80dB @ 10cm	14 ± 9	22	2 Pins	2000-2500Hz	-30° to +85°C
BST1811P-06	6	3 - 10	40	85dB @ 10cm	60 ± 9	90	2 Pins	2000-2500Hz	-30° to +85°C
BST1811P-12	12	6 - 15	40	85dB @ 10cm	120 ± 18	170	2 Pins	2000-2500Hz	-30° to +85°C
BRT2513P-06	5	3 - 5	80	85dB @ 10cm	27 ± 4	38	2 Pins	730Hz	-40° to +85°C
BRT2513P-06-S	6	3 - 8	75	85dB @ 10cm	36 ± 5	48	2 Pins	1000-1500Hz	-40° to +85°C
BRT2513P-12-S	12	8 - 14	55	85dB @ 10cm	120 ± 15	155	2 Pins	1000-1500Hz	-40° to +85°C

*Value Applying Rated Voltage (Resonant Frequency, 1/2 Duty Square Wave)

**Value Applying (Resonant Frequency, Sine Wave, Measuring Current 60uA)

BRT1209PF Series

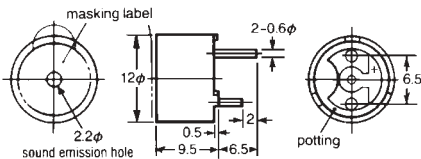

BRT1209P-C Series same as above but w/ 7.6mm pin spacing

BRT1209PF-05-RA Series

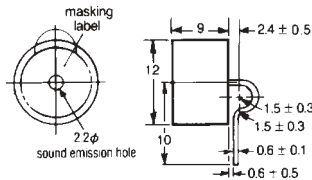

BRT1213P-01 Series

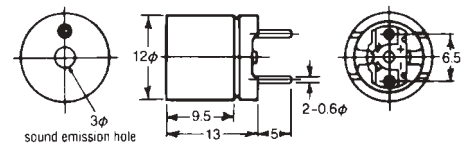

BRT1612P-12 Series

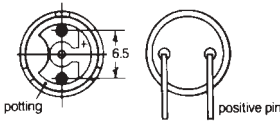
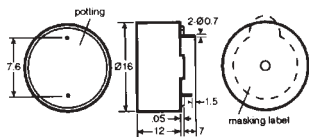

BRT1615 Series

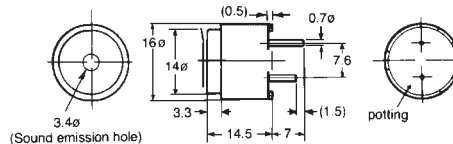

BRT1623 Series

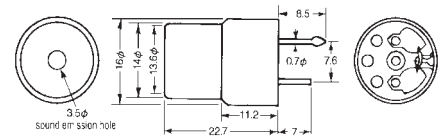

BRT1811P Series

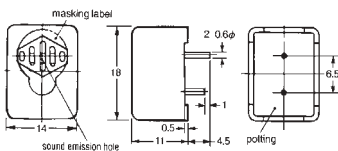

BRT2513P Series

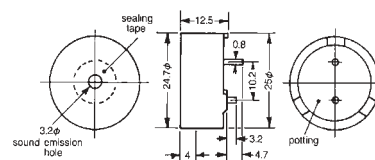

Electro Acoustic Transducers (continued)

Electro-Acoustic Transducers

Part Number	Rated Voltage (VDC)	Operating Voltage (VDC)	Max. Current (mA)	Sound Output	Terminal Type	Frequency	Operating Temperature	Tone Mode	Pulse Rate (Pulse/sec)
BRT2821L-06	6	4 - 9	35	90dB @ 30cm	2 Leadwires	2800Hz ± 0.2KHz	-20° to +60°C	Continuous	N/A
BRT2821L-12	12	9 - 15	40	95dB @ 30cm	2 Leadwires	2800Hz ± 0.2KHz	-20° to +60°C	Continuous	N/A
BRT2821L-24	24	15 - 28	25	95dB @ 30cm	2 Leadwires	2800Hz ± 0.2KHz	-20° to +60°C	Continuous	N/A
BRT2821P-06	6	4 - 9	35	90dB @ 30cm	2 Pins	2800Hz ± 0.2KHz	-20° to +60°C	Continuous	N/A
BRT2821P-12	12	9 - 15	40	95dB @ 30cm	2 Pins	2800Hz ± 0.2KHz	-20° to +60°C	Continuous	N/A
BRT2821P-24	24	15 - 28	25	95dB @ 30cm	2 Pins	2800Hz ± 0.2KHz	-20° to +60°C	Continuous	N/A
BRT2821L-06-P	6	4 - 9	10	78dB @ 30cm	2 Leadwires	2800Hz ± 0.2KHz	-20° to +60°C	Intermittent	2 - 7
BRT2821L-12-P	12	9 - 15	15	85dB @ 30cm	2 Leadwires	2800Hz ± 0.2KHz	-20° to +60°C	Intermittent	2 - 7
BRT2821L-24-P	24	15 - 28	20	85dB @ 30cm	2 Leadwires	2800Hz ± 0.2KHz	-20° to +60°C	Intermittent	2 - 7
BRT2821P-06-P	6	4 - 9	10	78dB @ 30cm	2 Pins	2800Hz ± 0.2KHz	-20° to +60°C	Intermittent	2 - 7
BRT2821P-12-P	12	9 - 15	15	85dB @ 30cm	2 Pins	2800Hz ± 0.2KHz	-20° to +60°C	Intermittent	2 - 7
BRT2821P-24-P	24	15 - 28	20	85dB @ 30cm	2 Pins	2800Hz ± 0.2KHz	-20° to +60°C	Intermittent	2 - 7
BRT2821L-06-D	6	4 - 9	35/10	85/70dB @ 30cm	3 Leadwires	2800Hz ± 0.2KHz	-20° to +60°C	Dual	2 - 7
BRT2821L-09-D	9	6 - 11	35/15	85/75dB @ 30cm	3 Leadwires	2800Hz ± 0.2KHz	-20° to +60°C	Dual	2 - 7
BRT2821L-12-D	12	8 - 15	40/15	90/80dB @ 30cm	3 Leadwires	2800Hz ± 0.2KHz	-20° to +60°C	Dual	2 - 7

BRT2821 Series

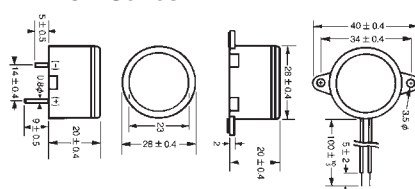

Surface Mount Piezo Buzzers

Part Number	Max Input Voltage	Electro-Static Capacitance (pf)	SPL Output (dB) (Min @ 10cm)	Resonant Frequency (Hz)	Operating Temperature
BSP1407SM-20	20vp-p	15000 ± 30% @ 120Hz	85dB @ 12vp-p @ 5KHz	5000 ± 500Hz	-20° to +70°C
BSP1602SM-25-GW	25vp-p	14000 ± 30% @ 1KHz	75dB @ 3vp-p @ 4KHz	4000 ± 500Hz	-20° to +70°C
BRP1705SM-30-GW	30vp-p	8000 ± 30% @ 120Hz	85dB @ 3vp-p @ 4KHz	4000 ± 500Hz	-20° to +70°C
BSP1708SM-20	20vp-p	15000 ± 30% @ 1KHz	88dB @ 10vp-p @ 5KHz	5000 ± 500Hz	-30° to +70°C
BSP1708SM-20-LF	20vp-p	22000 ± 30% @ 1KHz	85dB @ 7vp-p @ 3.6KHz	3600 ± 500Hz	-20° to +70°C
BSP1708SM-12-C	3 - 16vdc	N/A with built-in circuit	85dB @ 12vdc @ 4KHz	4000 ± 500Hz	-20° to +60°C
BSP2109SM-30-LF-GW	30vp-p	30000 ± 30% @ 1KHz	75dB @ 3vp-p @ 2KHz	2000 ± 500Hz	-20° to +120°C

BSP1407SM Series

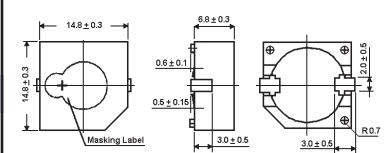

BSP1602SM-GW Series

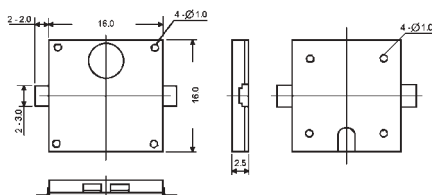

BRP1705SM-GW Series

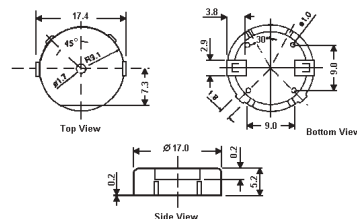

BSP1708SM-20 Series

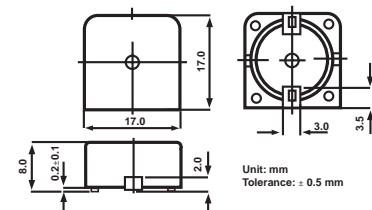

BSP1708SM-20-LF Series

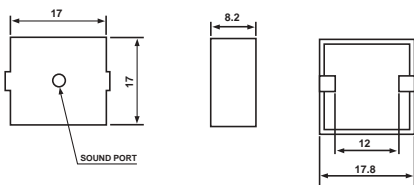

BSP1708SM-12-C Series

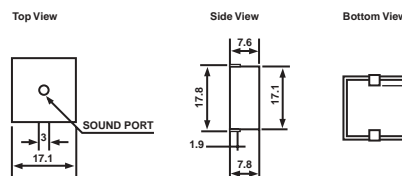

BRP2109SM-GW Series

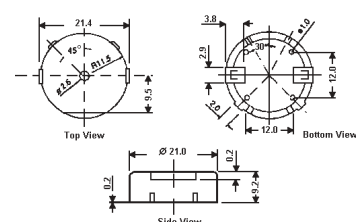

Piezo Electric Alarms - External Drive

Piezo Electric Alarms - External Drive

Part Number	Resonant Frequency (Hz)	Electrostatic Capacity (pF)	Max Input Voltage	Terminal Type	Operating Temperature	Sound Pressure Level
BRP1207P-30 BRP1207P-30-TR*	4000 ± 500Hz 4000 ± 500Hz	12,000 ± 30% 12,000 ± 30%	30Vp-p 30Vp-p	2 Pins 2 Pins	-20° to +60°C -20° to +60°C	70dB @10cm 3Vp-p 70dB @10cm 3Vp-p
BRP1305P-25	4000 ± 500Hz	11,000 ± 30%	25Vp-p	2 Pins	-30° to +85°C	80dB @10cm 10Vp-p
BRP1404L-30	4800 ± 500Hz	11,000 ± 30%	30Vp-p	2 Flying Leadwires	-30° to +80°C	85dB @10cm 10Vp-p
BRP1407P-20	4096Hz	10,000 ± 30%	20Vp-p	2 Pins	-20° to +70°C	80dB @10cm 5Vp-p
BRP1704L-30	4000 ± 1000Hz	10,000 ± 30%	30Vp-p	2 Leadwires	-20° to +60°C	80dB @10cm 9Vp-p
BRP1708P-30	4500 ± 500Hz	8000 ± 30%	30Vp-p	2 Pins	-20° to +60°C	95dB @30cm 10Vp-p
BRP2207P-30	4000 ± 500Hz	12,000 ± 30%	30Vp-p	2 Pins	-40° to +120°C	95dB @30cm 10Vp-p
BRP2211P-30	2000 ± 500Hz	19,000 ± 30%	30Vp-p	2 Pins	-20° to +85°C	75dB @10cm 3Vp-p
BRP2304FL-40	5000 ± 500Hz	15,000 ± 30%	40Vp-p	2 Flying Wires	-20° to +60°C	70dB @30cm 12Vp-p
BRP2304L-30	5500 ± 500Hz	12,000 ± 30%	30Vp-p	2 Leadwires	-20° to +60°C	80dB @10cm 10Vp-p
BRP2311P-30-WP*	2500 ± 500Hz	24,000 ± 30%	30Vp-p	2 Long Pins	-20° to +60°C	85dB @30cm 12Vp-p
BRP2405L-30	4000 ± 500Hz	17,000 ± 30%	30Vp-p	2 Leadwires	-20° to +70°C	80dB @10cm 10Vp-p
BRP2406L-30	3000 ± 500Hz	30,000 ± 30%	30Vp-p	2 Leadwires	-20° to +70°C	85dB @10cm 3Vp-p
BRP2407L-30 BRP2407P-30	5600 ± 600Hz 5600 ± 600Hz	10,000 ± 30% 10,000 ± 30%	30Vp-p 30Vp-p	2 Leadwires 2 Pins	-20° to +60°C -20° to +60°C	90dB @30cm 10Vp-p 90dB @30cm 10Vp-p
BRP2711P-30	5600 ± 600Hz	10,000 ± 30%	30Vp-p	2 Pins	-20° to +60°C	90dB @30cm 10Vp-p
BRP3005L-30	4500 ± 500Hz	20,000 ± 30%	30Vp-p	2 Pins	-20° to +60°C	95dB @30cm 10Vp-p
BRP3006P-30	1300 ± 500Hz	45,000 ± 30%	30Vp-p	2 Pins	-20° to +60°C	75dB @30cm 12Vp-p
BRP3008P-30 BRP3008P-30-LF	4600 ± 500Hz 2800 ± 500Hz	20,000 ± 30% 20,000 ± 30%	30Vp-p 30Vp-p	2 Pins 2 Pins	-20° to +60°C -20° to +60°C	90dB @10cm 5Vp-p 95dB @10cm 30Vp-p
BRP3009P-30	2000 ± 500Hz	45,000 ± 30%	30Vp-p	2 Pins	-20° to +60°C	85dB @10cm 12Vp-p
BSP2226FV-30	2000 ± 500Hz	18,000 ± 30%	30Vp-p	2 Fast-on	-20° to +70°C	70dB @10cm 3Vp-p
BSP3206FV-30	3000 ± 500Hz	16,000 ± 30%	30Vp-p	2 Fast-on	-20° to +60°C	95dB @30cm 10Vp-p

BRP1207P-30 + BRP1207P-30-TR Series

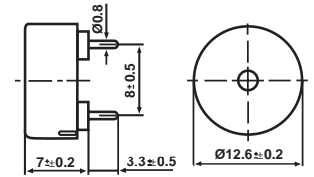

BRP1305P-25 Series

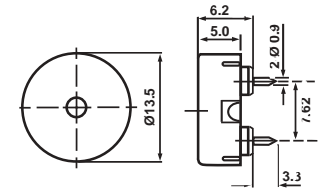

BRP1404L-30 Series

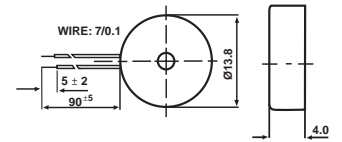

BRP1407P-20 Series

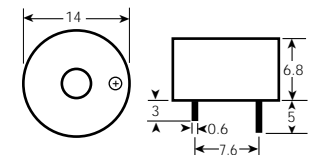

*Model BRP1207P-30-TR on tape and reel with 5mm pin spacing
*Model BRP2311P-30-WP is waterproof

BRP1704L-30 Series

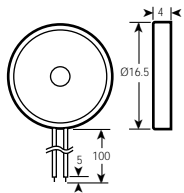

BRP1708P-30 Series

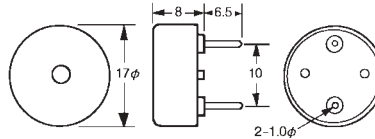

BRP2207P-30 Series

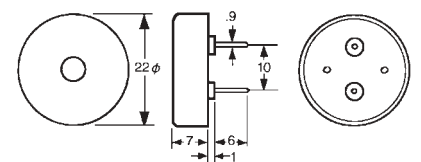

BRP2211P-30 Series

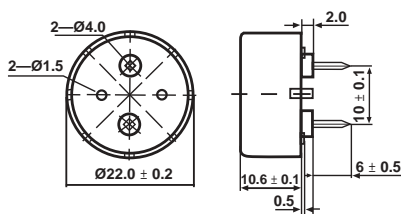

BRP2304FL-40 Series

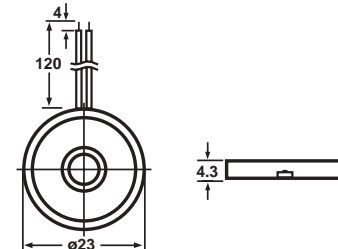

BRP2304L-30 Series

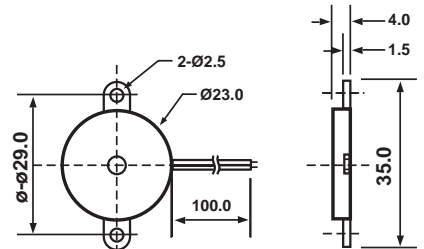

Piezo Electric Alarms - External Drive

BRP2311P-30-WP Series

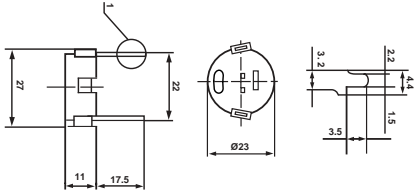

BRP2405L-30 Series

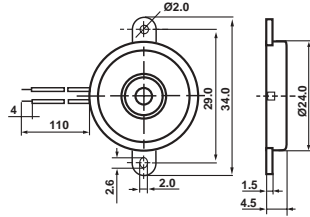

BRP2406L-30 Series

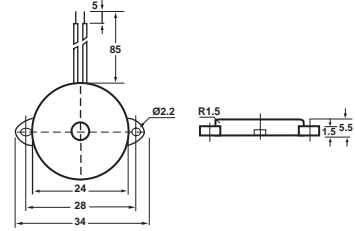

BRP2407 Series

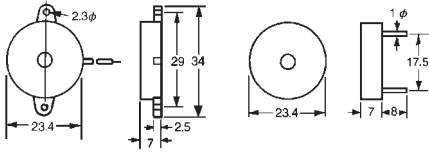

BRP2711P-30 Series

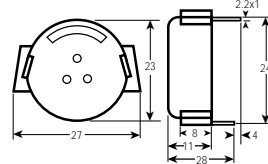

BRP3005 Series

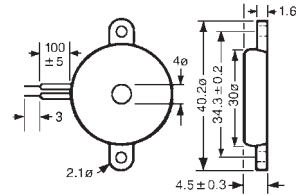

BRP3006P-30 Series

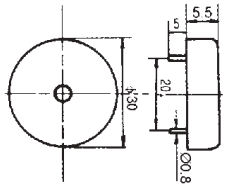

BRP3008P-30 Series

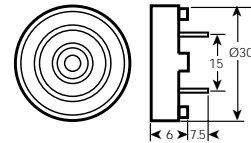

BRP3008-P-30-LF Series

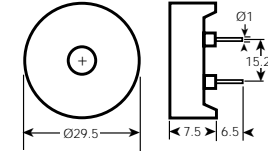

BRP3009P-30 Series

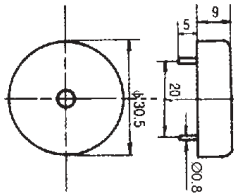

BSP2226FV-30 Series

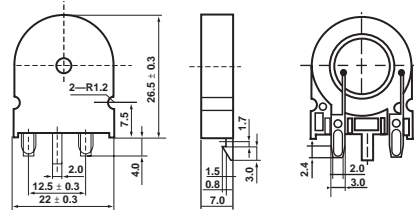

BSP3206 Series

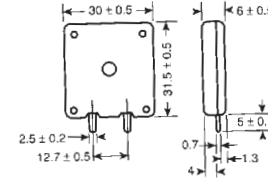

Piezo Buzzers

Piezo Buzzers - External Drive, Dual Control

Part Number	Operating Frequency (Hz)	Capacitance @ 120Hz/1V(±30%) (uF)	Operating Voltage Continuous Sine Wave/Square Wave	Operating Voltage Intermittent Sine Wave/Square Wave	SPL Square Wave (dB) Min	SPL Sine Wave Min	Operating Temperature
BRP3007P-D	2000 - 6000	0.200	85Vp-p/50Vp-p	100Vp-p/60Vp-p	85@5.5KHz@3m/18Vp-p	82@5.5KHz@3m/18Vp-p	-40° to +105°C
BRP4514T-D	2200 - 4000	0.235	85Vp-p/50Vp-p	100Vp-p/60Vp-p	102@3.0KHz@30cm/12Vp-p	100@3.0KHz@30cm/12Vp-p	-40° to +105°C
BRP5217P-D	2000 - 4000	0.235	85Vp-p/50Vp-p	100Vp-p/60Vp-p	85@3.2KHz@3m/18Vp-p	82@3.2KHz@3m/18Vp-p	-40° to +105°C

BRP3007P-D Series

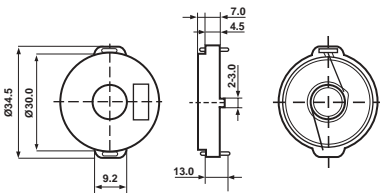

BRP4514T-D Series

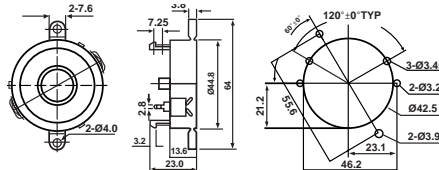

BRP5217P-D Series

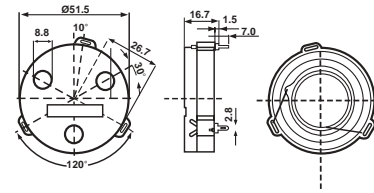

Piezo Buzzers - Self-Drive

Part Number	Resonant Frequency (Hz)	Electrostatic Capacity (pf)	Max Input Voltage	Terminal Type	Operating Temperature	Sound Pressure Level
BRP1407L-20-F BRP1407P-20-F	4100 ± 500Hz 4100 ± 500Hz	16,000 ± 30% 16,000 ± 30%	20Vp-p 20Vp-p	3 Flying Wires 3 Pins	-30° to +85°C -30° to +85°C	70dB @30cm 12Vp-p 70dB @30cm 12Vp-p
BRP2307L-30	4000 ± 500Hz	14,000 ± 30%	30Vp-p	3 Leadwires	-20° to +60°C	85dB @30cm 12Vp-p
BRP2308P-30	3000 ± 500Hz	15,000 ± 30%	30Vp-p	3 Pins	-20° to +70°C	80dB @30cm 12Vp-p
BRP2404L-20	6500 ± 500Hz	12,000 ± 30%	20Vp-p	3 Leadwires	-20° to +70°C	85dB @10cm 12Vp-p
BRP2411P-30	3600 ± 500Hz	25,000 ± 30%	30Vp-p	3 Pins	-20° to +60°C	95dB @10cm 12Vp-p
BRP2415L-30	3000 ± 500Hz	20,000 ± 30%	30Vp-p	3 Leadwires	-30° to +80°C	76dB @30cm 12Vp-p
BRP2507P-30	6400 ± 500Hz	12,000 ± 30%	30Vp-p	3 Pins	-20° to +110°C	85dB @10cm 12Vp-p
BRP2908P-30	3500 ± 500Hz	25,000 ± 30%	30Vp-p	3 Pins	-20° to +70°C	85dB @10cm 12Vp-p
BRP3010F-25	2700 ± 500Hz	25,000 ± 30%	25Vp-p	3 Pins	-0° to +120°C	75dB @100cm 12Vp-p
BRP3012P-30	3600 ± 500Hz	25,000 ± 30%	30Vp-p	3 Pins	-20° to +60°C	88dB @10cm 12Vp-p
BRP3408P-30	2500 ± 500Hz	25,000 ± 30%	30Vp-p	3 Pins	-20° to +60°C	95dB @30cm 15Vp-p

BRP1407L-20-F Series

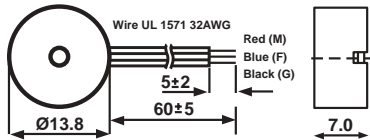

BRP1407P-20-F Series

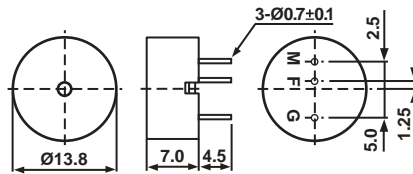

BRP2307L-30 Series

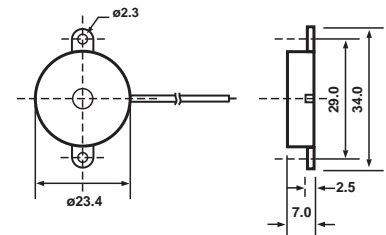

BRP2308P-30 Series

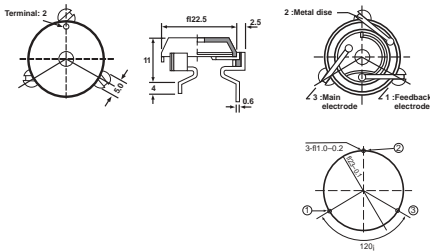

BRP2404L-20 Series

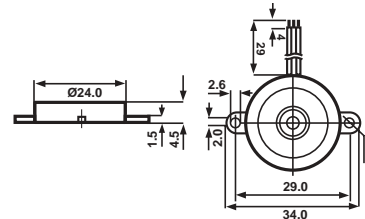

BRP2411P-30 Series

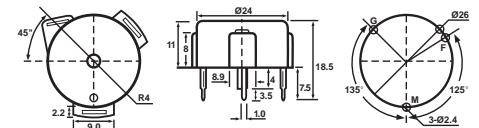

BRP2415L-30 Series

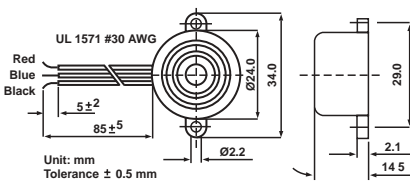

BRP2507P-30 Series

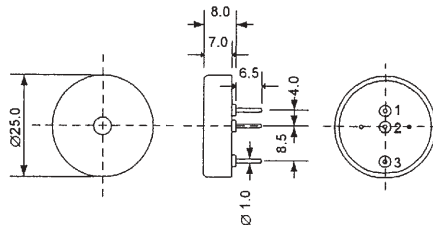

BRP2908P-30 Series

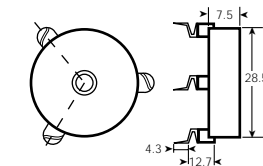

BRP3012P-30 Series

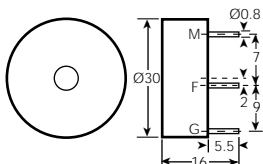

BRP3010F-25 Series

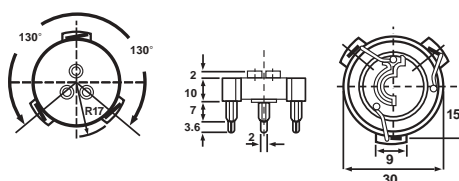

BRP3408P-30 Series

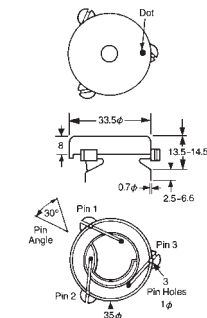

Piezo Buzzers - Self-Drive

Part Number	Resonant Frequency (Hz)	Electrostatic Capacity (pf)	Max Input Voltage	Terminal Type	Operating Temperature	Sound Pressure Level
BRP4016P-30	3200 ± 500Hz	30,000 ± 30%	30Vp-p	3 Pins	-20° to +60°C	95dB @30cm9Vp-p
BRP4216L-30	3000 ± 500Hz	25,000 ± 30%	30Vp-p	3 Leadwires	-20° to +60°C	85dB @1M15Vp-p
BRP4216P-30	3000 ± 500Hz	25,000 ± 30%	30Vp-p	3 Pins	-20° to +60°C	85dB @1M15Vp-p

BRP4016P Series

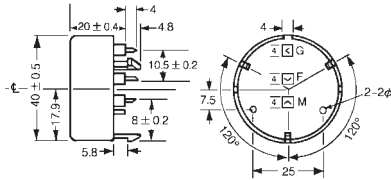

BRP4216 Series

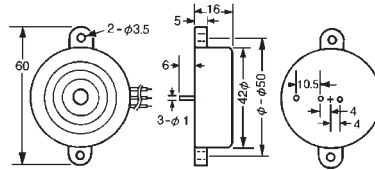

Piezo Electric Alarms

Piezo Electric Alarms with Internal Circuitry

Part Number	Rated Voltage (VDC)	Operating Voltage (VDC)	Max. Current (mA)	Min. Sound Output Level	Terminal Type	Tone Mode Pulse/Second	Frequency	Operating Temperature
BRP1209P-12-C	12	2.5 - 15	8	75dB @ 30cm	2 Pins	Continuous	5000 ± 500Hz	-20° to +70°C
BRP1408P-12-CS*	12	3 - 16	7	80dB @ 30cm	2 Pins	Continuous	4000 ± 500Hz	-40° to +120°C
BRP1514P-05-C	5	1 - 12	15	83dB @ 10cm	2 Pins	Continuous	4000 ± 500Hz	-20° to +60°C
BRP1514P-12-C	12	1 - 18	20	85dB @ 10cm	2 Pins	Continuous	4000 ± 500Hz	-20° to +60°C
BRP2211P-12-C	12	3 - 15	4.5	75dB @ 30cm	2 Pins	Continuous	4000 ± 500Hz	-20° to +70°C
BRP2211P-12-CS	12	3 - 15	4.5	75dB @ 100cm	2 Pins	Continuous	4000 ± 500Hz	-30° to +110°C
BRP2212L-12-C	12	3 - 15	4.5	90dB @ 30cm	2 Leadwires	Continuous	4000 ± 500Hz	-10° to +60°C
BRP2212P-12-C	12	3 - 15	4.5	90dB @ 30cm	2 Pins	Continuous	4000 ± 500Hz	-10° to +60°C
BRP2307L-12-C	12	3 - 24	5	75dB @ 30cm	2 Leadwires	Continuous	4000 ± 500Hz	-20° to +70°C

*Indicates Wave Solderable and Washable

BRP1209P-12-C Series

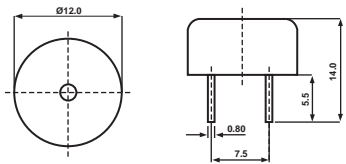

BRP1408P-12-CS Series

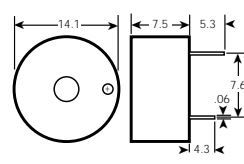

BRP1514P-C Series

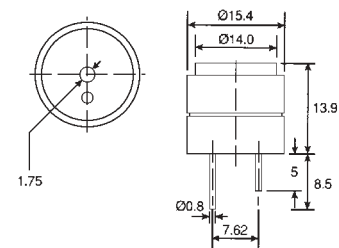

BRP2211P-12-C/CS Series

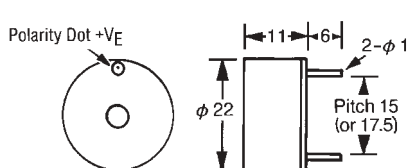

BRP2212L-12-C Series

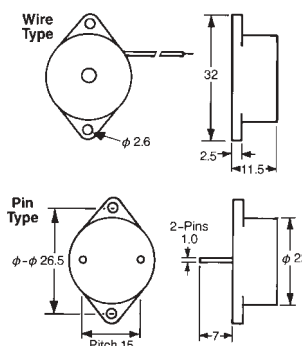

BRP2307L-12-C Series

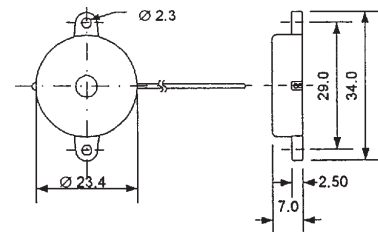

Piezo Electric Alarms (continued)

Piezo Electric Alarms with Internal Circuitry

Part Number	Rated Voltage (VDC)	Operating Voltage (VDC)	Max. Current (mA)	Min. Sound Output Level	Terminal Type	Tone Mode Pulse/Second	Frequency	Operating Temperature
BRP2307P-12-C	12	8 - 18	10	85dB @ 30cm	2 Pins	Continuous	3200 ± 500Hz	-30° to +80°C
BRP2307P-12-CFS*	12	3 - 15	5	75dB @ 30cm	2 Pins	Continuous	4000 ± 500Hz	-20° to +105°C
BRP2307PH-12-C	12	3 - 24	5	75dB @ 30cm	2 Horizontal Pins 2 Vertical Pins	Continuous	3500 ± 500Hz	-20° to +70°C
BRP2307PV-12-C	12	3 - 24	5	75dB @ 30cm	2 Vertical Pins	Continuous	3500 ± 500Hz	-20° to +70°C
BRP2310P-12-CP	12	3 - 24	15	80dB @ 30cm	2 Pins	Intermittent 1:1	3500 ± 500Hz	-20° to +80°C
BRP2312L-12-C	12	3 - 20	8	85dB @ 30cm	2 Leadwires	Continuous	3000 ± 500Hz	-20° to +60°C
BRP2317L-12-C	12	3 - 16	8	90dB @ 30cm	2 Leadwires	Continuous	3700 ± 500Hz	-20° to +60°C
BRP2410P-12-C	12	3 - 20	10	95dB @ 10cm	2 Pins	Continuous	3400 ± 500Hz	-20° to +70°C
BRP2411P-12-CFS*	12	3 - 15	10	90dB @ 30cm	2 Pins	Continuous	3700 ± 500Hz	-40° to +120°C
BRP2416P-12-C	12	3 - 20	10	85dB @ 30cm	2 Pins	Continuous	2800 ± 500Hz	-20° to +70°C
BRP2416P-12-CFS*	12	3 - 20	10	85dB @ 30cm	2 Pins	Continuous	2800 ± 500Hz	-20° to +70°C
BRP2522P-12-C	12	9 - 12	50	100dB @ 30cm	2 Pins	Continuous	2800 ± 500Hz	-20° to +65°C

*Indicates Wave Solderable and Washable

BRP2307P-12-CFS Series

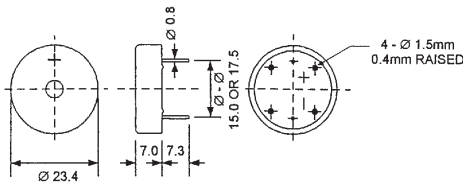

BRP2307P-12-C Series

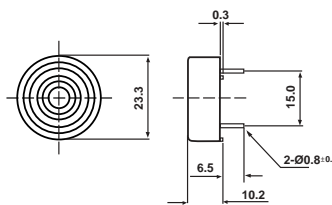

BSP2307PH-12-C Series

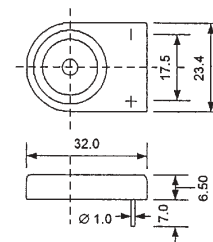

BSP2307PV-12-C Series

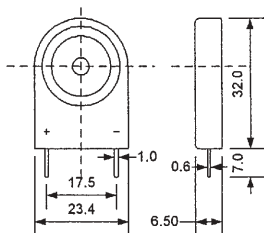

BRP2310P-12-CP Series

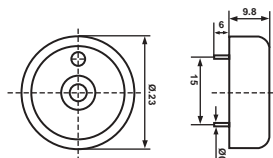

BRP2312L-12-C Series

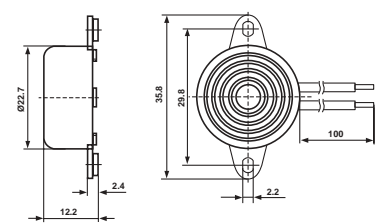

BRP2317L-12-C Series

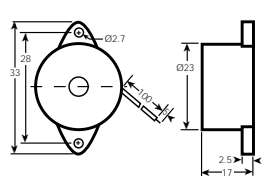

BRP2410P-12-C Series

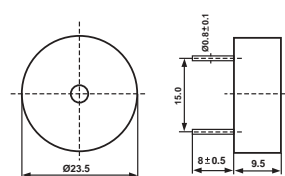

BRP2411P-12-CFS Series

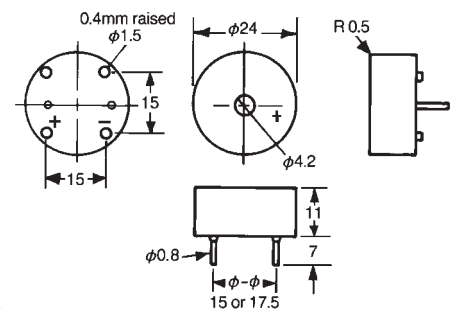

BRP2416P-12-C Series

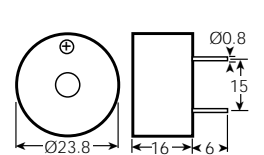

BRP2522P-12-C Series

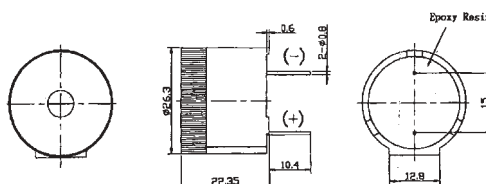

Piezo Electric Alarms (continued)

Piezo Electric Alarms with Internal Circuitry

Part Number	Rated Voltage (VDC)	Operating Voltage (VDC)	Max. Current (mA)	Min. Sound Output Level	Terminal Type	Tone Mode Pulse/Second	Frequency	Operating Temperature
BRP3018L-12-C	12	3 - 15	10	90dB @ 30cm	2 Leadwires	Continuous	2000 ± 500Hz	-10° to +60°C
BRP3018L-12-CP	12	3 - 15	10	88dB @ 30cm	2 Leadwires	Intermittent 1:1	2000 ± 500Hz	-10° to +60°C
BRP3018P-12-C	12	3 - 15	10	90dB @ 30cm	2 Pins	Continuous	2000 ± 500Hz	-10° to +60°C
BRP3018P-12-CP	12	3 - 15	10	88dB @ 30cm	2 Pins	Intermittent 1:1	2000 ± 500Hz	-10° to +60°C
BRP3020P-03-C	3	2 - 5	9	90dB @ 30cm	2 Pins	Continuous	3500 ± 500Hz	-25° to +65°C
BRP3020P-12-C	12	3 - 20	10	90dB @ 30cm	2 Pins	Continuous	3500 ± 500Hz	-25° to +55°C
BRP3021P-12-CD	12	3 - 16	15	80dB @ 30cm	3 Pins	Cont/Intermitt 1:1	3500 ± 500Hz	-20° to +80°C
BRP3025L-12-C	12	1.5 - 16	15	95dB @ 30cm	2 Leadwires	Continuous	3500 ± 500Hz	-20° to +60°C
BRP3025L-12-CP	12	6 - 16	10	90dB @ 30cm	2 Leadwires	Intermittent 3:1	3500 ± 500Hz	-20° to +60°C
BRP3025L-12-CD	12	6 - 16	15/10	95/90dB @ 30cm	3 Leadwires	Cont/Intermitt 3:1	3500 ± 500Hz	-20° to +60°C
BRP3025L-24-C	24	1.5 - 28	20	95dB @ 30cm	2 Leadwires	Continuous	3500 ± 500Hz	-20° to +60°C
BRP3025L-24-CP	24	6 - 28	15	90dB @ 30cm	2 Leadwires	Intermittent 3:1	3500 ± 500Hz	-20° to +60°C
BRP3025L-24-CD	24	6 - 28	20/15	95/90dB @ 30cm	3 Leadwires	Cont/Intermitt 3:1	3500 ± 500Hz	-20° to +60°C
BRP3214L-12-C	12	3 - 30	10	90dB @ 50cm	2 Leadwires	Continuous	2700 ± 500Hz	-40° to +70°C
BRP3214L-12-CP	12	3 - 30	10	88dB @ 50cm	2 Leadwires	Intermittent 0.5:1	2700 ± 500Hz	-40° to +70°C
BRP3214P-12-CS	12	3 - 30	10	90dB @ 50cm	2 Pins	Continuous	2000 ± 500Hz	-40° to +120°C
BRP3633T-12-C	12	8 - 24	20	90dB @ 30cm	2 Lugs	Continuous	2600 ± 500Hz	-20° to +60°C
BRP3633T-12-CP	12	8 - 24	20	88dB @ 30cm	2 Lugs	Intermittent 1:1	2600 ± 500Hz	-20° to +60°C
BRP3633T-12-CD	12	8 - 24	20	90/88dB @ 30cm	3 Lugs	Cont/Intermitt 1:1	2600 ± 500Hz	-20° to +60°C
BRP3633T-12-DB	12	8 - 24	20	90dB @ 30cm	2 Lugs	Door Bell	2600 ± 500Hz	-20° to +60°C

BRP3018 Series

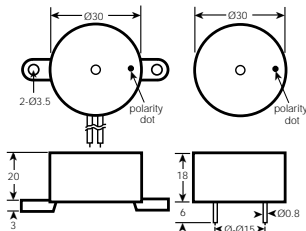

BRP3020P-C Series

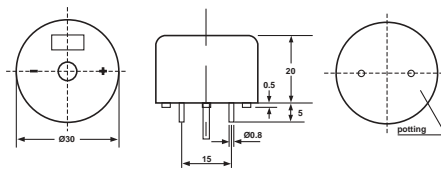

BRP3021P-12-CD Series

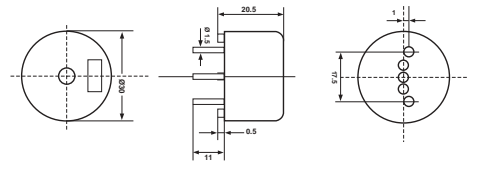

BRP3025 Series

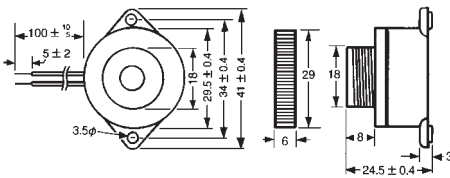

BRP3214L-C Series

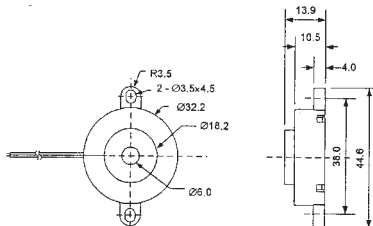

BRP3214P-12-CS Series

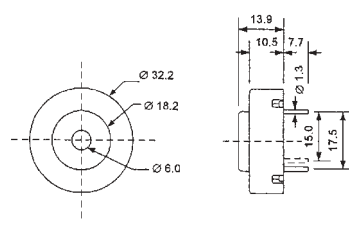

BRP3633T Series

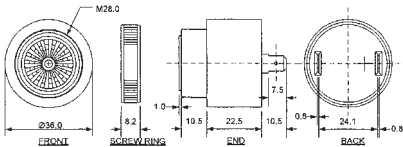

BRP3633T-12-CD Series

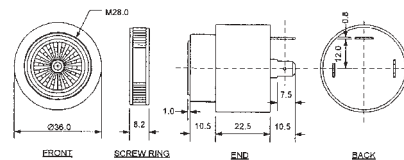

Piezo Electric Alarms (continued)

Piezo Electric Alarms with Internal Circuitry

Part Number	Rated Voltage (VDC)	Operating Voltage (VDC)	Max. Current (mA)	Min. Sound Output Level	Terminal Type	Tone Mode Pulse/Second	Frequency	Operating Temperature
BRP3724T-24-C	24	4 - 28	18	83dB @ 60cm	2 Lugs	Continuous	3600 ± 500Hz	-20° to +60°C
BRP3724T-24-CP	24	6 - 28	18	80dB @ 60cm	2 Lugs	Slow Pulse 0.8-1.2	3600 ± 500Hz	-20° to +60°C
BRP3724T-24-CP1	24	6 - 28	18	80dB @ 60cm	2 Lugs	Fast Pulse 4 - 6	3600 ± 500Hz	-20° to +60°C
BRP3724T-24-CD	24	6 - 28	18	80dB @ 60cm	3 Lugs	Cont/Slow Pulse 0.8-1.2	3600 ± 500Hz	-20° to +60°C
BRP3724T-24-CD1	24	6 - 28	18	80dB @ 60cm	3 Lugs	Cont/Fast Pulse 4 - 6	3600 ± 500Hz	-20° to +60°C
BRP4020P-06-C	6	5 - 9	30	100dB @ 30cm	2 Pins	Continuous	3200 ± 500Hz	-20° to +60°C
BRP4214P-12-C-H	12	8 - 18	10	94dB @ 30cm	2 Pins	Continuous	3000 ± 500Hz	-30° to +80°C
BRP4222T-24-C	24	1 - 28	15	85dB @ 30cm	2 Lugs	Continuous	2900 ± 500Hz	-20° to +60°C
BRP4314P-12-C	12	3 - 28	8	90dB @ 30cm	2 Pins	Continuous	2800 ± 500Hz	-20° to +60°C
BRP4314P-12-CFS*	12	3 - 28	8	90dB @ 30cm	2 Pins	Continuous	2800 ± 500Hz	-20° to +60°C
BRP4326T-12-C	12	5 - 28	18	80dB @ 1M	2 Lugs	Continuous	3000 ± 500Hz	-20° to +60°C
BRP4326T-12-CP	12	5 - 28	18	80dB @ 1M	2 Lugs	Intermitt: 4-6	3000 ± 500Hz	-20° to +60°C
BRP4326T-12-CD	12	5 - 28	18	80dB @ 1M	3 Lugs	Cont/Interm: 4-6	3000 ± 500Hz	-20° to +60°C

*Indicates Wave Solderable and Washable

BRP3724T-C Series

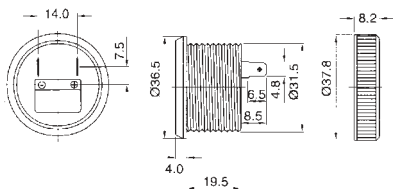

BRP3724T-CP/CP1 Series

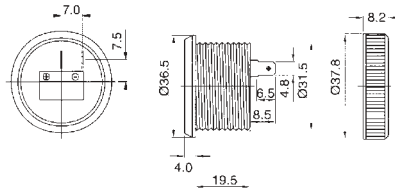

BRP3724T-CD/CD1 Series

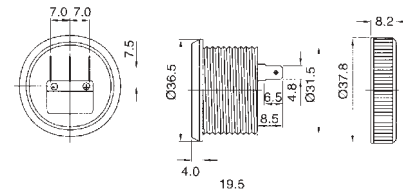

BRP4020P-06-C Series

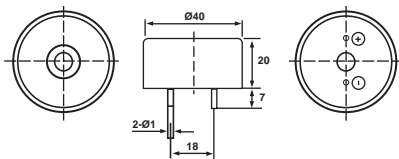

BRP4214P-12-C-H Series

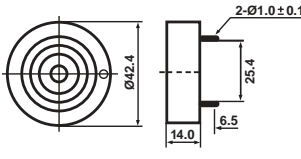

BRP4222T Series

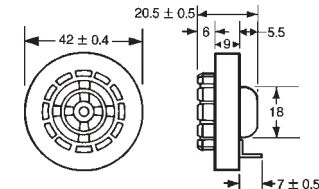

BRP4314P-12-C/CFS

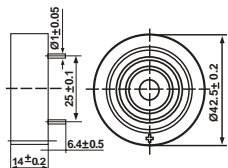

BRP4326T-C Series

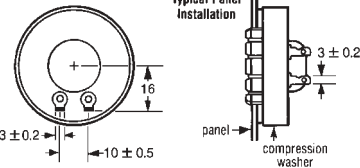
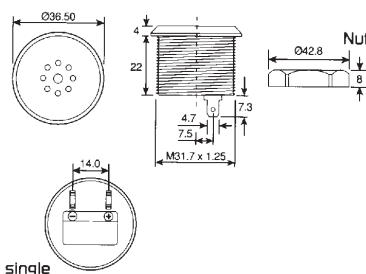

BRP4326T-CP Series

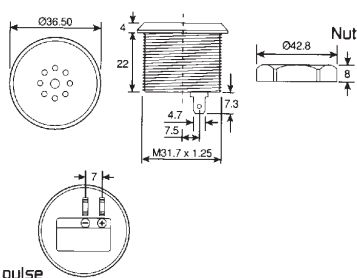

BRP4326T-CD Series

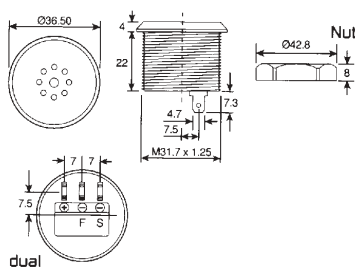

Piezo Electric Alarms (continued)

Piezo Electric Alarms with Internal Circuitry

Part Number	Rated Voltage (VDC)	Operating Voltage (VDC)	Max. Current (mA)	Min. Sound Output Level	Terminal Type	Tone Mode Pulse/Second	Frequency	Operating Temperature
BRP4526L-12-C	12	1 - 13	35	105dB @ 30cm	2 Leadwires	Continuous	2900 ± 500Hz	-20° to +60°C
BRP4526P-12-C	12	1 - 13	35	105dB @ 30cm	3 Pins	Continuous	2900 ± 500Hz	-20° to +60°C
BRP4535S-12-C	12	1 - 16	30	100dB @ 30cm	2 Screw Lugs	Continuous	2900 ± 500Hz	-20° to +60°C
BRP4535S-24-C	24	1 - 28	15	90dB @ 30cm	2 Screw Lugs	Continuous	2900 ± 500Hz	-20° to +60°C
BRP4535S-12-CP	12	4 - 16	20	90dB @ 30cm	2 Screw Lugs	Intermitt: 0.8-1.2	2900 ± 500Hz	-20° to +60°C
BRP4535S-24-CP	24	4 - 28	22	80dB @ 30cm	2 Screw Lugs	Intermitt: 0.8-1.2	2900 ± 500Hz	-20° to +60°C
BRP4535S-12-CP1	12	4 - 16	20	90dB @ 30cm	2 Screw Lugs	Intermitt: 4 - 6	2900 ± 500Hz	-20° to +60°C
BRP4535S-24-CP1	24	4 - 28	22	80dB @ 30cm	2 Screw Lugs	Intermitt: 4 - 6	2900 ± 500Hz	-20° to +60°C
BRP4535S-12-CD	12	4 - 16	25/20	95/90dB @ 30cm	3 Screw Lugs	Cont/Interm:0.8-1.2	2900 ± 500Hz	-20° to +60°C
BRP4535S-24-CD	24	4 - 28	30/20	85/80dB @ 30cm	3 Screw Lugs	Cont/Interm:0.8-1.2	2900 ± 500Hz	-20° to +60°C
BRP5331L-06-C	6	3 - 12	10	93dB @ 30cm	2 Leadwires	Continuous	2800 ± 500Hz	-20° to +60°C

BRP4526 Series

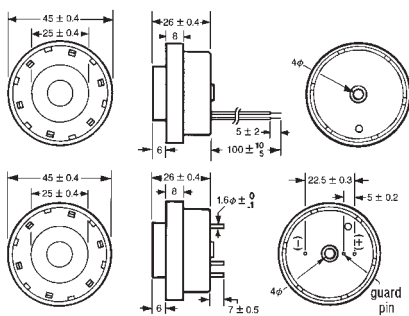

BRP4535 Series

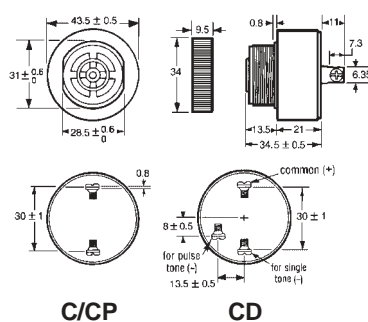

BRP5331L-06-C Series

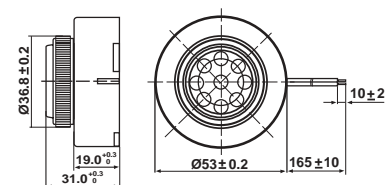

Volume Control for Panel Mount Series BRP4535 and BRP4549

Part Number	VC45S	Includes Mounting Plate, Shutter and Screw
	VC45S	Includes Mounting Plate, Shutter and Screw

VC45S

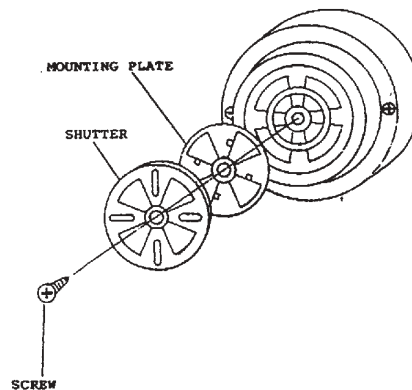

Piezo Sounders 100dB or Greater

Sounders with Built-in Circuit

Part Number	Rated Voltage (VDC)	Operating Voltage (VDC)	Max. Current (mA)	Min. Sound Output Level	Terminal Type	Tone Mode Pulse/Second	Frequency	Operating Temperature
BRP3922L-12-CT3	12	6-15	95	107dB @ 100cm	5 Leadwires	3 Tone	2800Hz	-20° to +70°C
BRP3922L-24-CT3	24	6-28	85	109dB @ 100cm	5 Leadwires	3 Tone	2800Hz	-20° to +70°C
BRP3926L-12-C	12	3-24	18	101dB @ 100cm	2 Leadwires	Continuous	3000Hz	-20° to +60°C
BRP3926L-12-CP	12	3-24	18	101dB @ 100cm	2 Leadwires	Intermitt: 1-1	3000Hz	-20° to +60°C
BRP4016L-12-C	12	3-24	18	100dB @ 100cm	2 Leadwires	Continuous	2800 ± 300Hz	-20° to +60°C
BRP4016L-12-CP	12	3-24	18	100dB @ 100cm	2 Leadwires	Intermitt: 1-1	2800 ± 300Hz	-20° to +60°C
BPS4218L-09-C	9	6-12	150	100dB @ 30cm	2 Leadwires	Siren	1500 ± 3500Hz	-20° to +60°C
BPS4228L-12-C	12	6-15	90	107dB @ 1M	2 Leadwires	Siren	2800Hz	-20° to +70°C
BPS4228L-24-C	24	6-28	50	109dB @ 1M	2 Leadwires	Siren	2800Hz	-20° to +70°C
BPS4228L-12-CS-DA	12	6-14	150	110dB @ 1M	2 Leadwires	Siren	2000 - 3500Hz	-10° to +55°C
BPS4358L-12-C	12	6-12	160	105dB @ 1M	2 Leadwires	Siren	2500 - 3000Hz	-20° to +70°C
BRP4629T-09-C	9	5-13	70	105dB @ 1M	3 Lugs	Continuous	2000 - 3000Hz	-20° to +65°C

BRP3922L-C Series

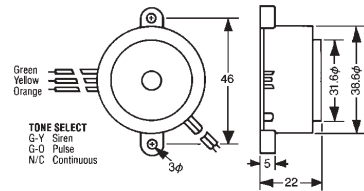

BRP3926 Series

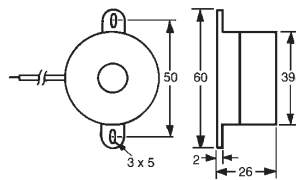

BRP4016 Series

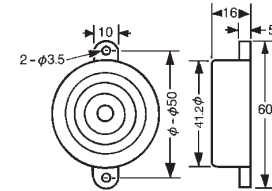

BPS4218L-09-C Series

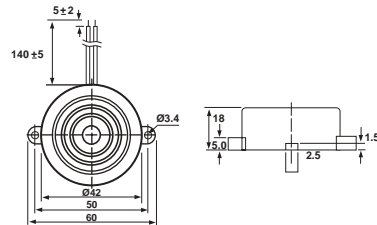

BPS4228L Series

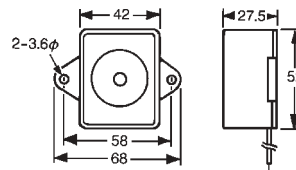

BPS4228L-12-CS-DA Series

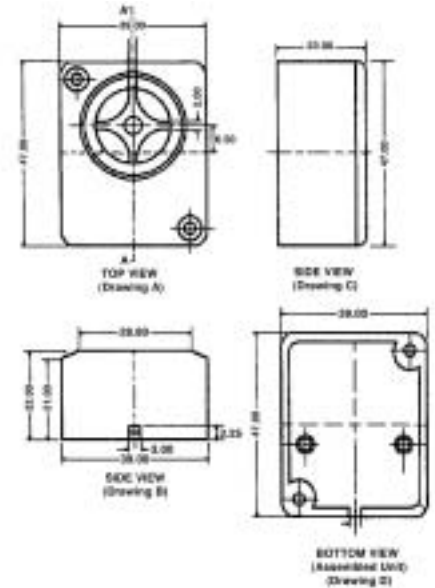

BPS4358L-12-C Series

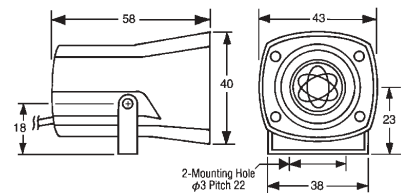

BRP4629T-09-C Series

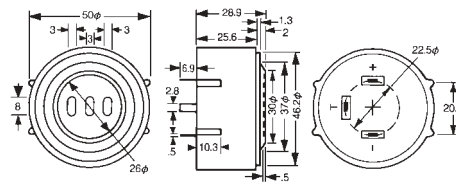

Sounders with Built-in Circuit

Part Number	Rated Voltage (VDC)	Operating Voltage (VDC)	Max. Current (mA)	Min. Sound Output Level	Terminal Type	Tone Mode Pulse/Second	Frequency	Operating Temperature
BRP5038L-12-C	12	1.5 - 16	45	105dB @ 30cm	2 Leadwires	Continuous	3200 - 500Hz	-20° to +60°C
BRP5038L-12-CP	12	3 - 16	45	105dB @ 30cm	2 Leadwires	Intermitt: 0.8-1.2	3200 - 500Hz	-20° to +60°C
BRP5038L-12-CP1	12	3 - 16	45	105dB @ 30cm	2 Leadwires	Intermitt: 2-3	3200 - 500Hz	-20° to +60°C
BRP5038L-12-CD	12	6 - 16	65	105dB @ 30cm	3 Leadwires	Dual	3200 - 500Hz	-20° to +60°C
BPS5251L-12-C	12	6 - 15	280	105dB @ 1M	2 Leadwires	Siren	1500 - 4000Hz	-20° to +60°C
BPS5251L-24-C	24	18 - 26	105	100dB @ 1M	2 Leadwires	Siren	1500 - 4000Hz	-20° to +60°C
BPS5556L-12-C	12	6 - 16	260	105dB @ 1M	2 Leadwires	Siren	2000 - 4000Hz	-20° to +60°C
BPS6055L-12-C	12	6 - 12	350	115dB @ 1M	2 Leadwires	Siren	2500 - 3000Hz	-20° to +70°C
BPS8432L-12-C	12	6 - 15	85	105dB @ 1M	2 Leadwires	Continuous	2500 - 2800Hz	-20° to +70°C
BPS8432L-24-C	24	6 - 28	45	105dB @ 1M	2 Leadwires	Continuous	2500 - 2800Hz	-20° to +70°C
BPS8542L-12-C	12	6 - 15	280	105dB @ 1M	2 Leadwires	Siren	2800 ± 500Hz	-20° to +60°C
BPS9234S-12-C	12	6 - 15	300	115dB @ 1M	Screw	3 - Tone	2800Hz	-20° to +70°C
BPS9234S-24-C	24	6 - 28	150	115dB @ 1M	Screw	Cont., Siren or Pulse	2800Hz	-20° to +70°C
BPS9295L-12-C	12	6 - 15	350	120dB @ 30cm	2 Leadwires	Siren	1300 - 1900Hz	-10° to +50°C
BPS9295L-12-CL	12	6 - 15	650	123dB @ 30cm	2 Leadwires	Siren	1300 - 1900Hz	-10° to +50°C
BPS136152L-12-C	12	6 - 15	350	122dB @ 30cm	2 Leadwires	Siren	1300 - 1900Hz	-10° to +50°C

BRP5038L Series

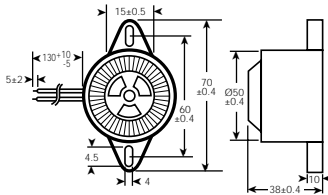

BPS5251L-C Series

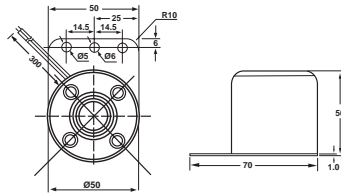

BPS5556L-12-C Series

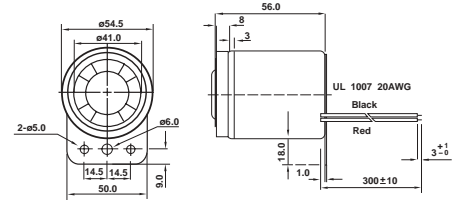

BPS6055L Series

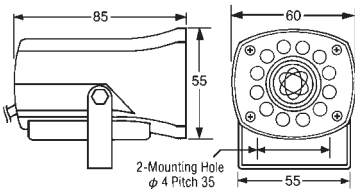

BPS8432L Series

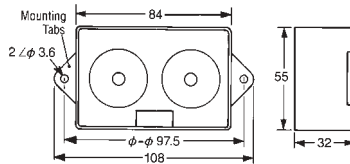

BPS8542L-12-C Series

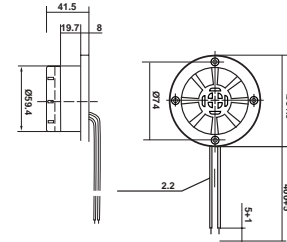

BPS9234S Series

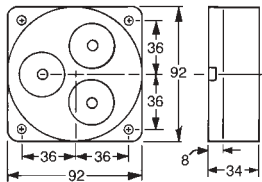

BPS9295L Series

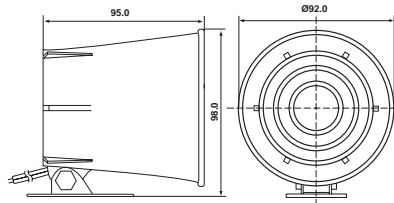

BPS136152L-12-C Series

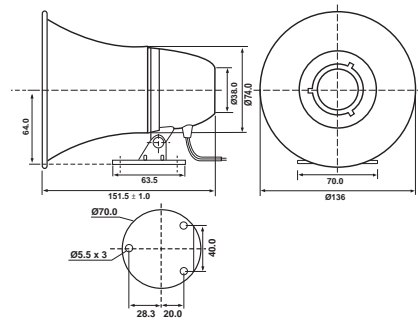

Miscellaneous Audible Signal Devices

Melody Buzzers

Part Number	Rated Voltage (VDC)	Operating Voltage (VDC)	Current @ Rated Voltage	Sound Output Level	Terminal Type	Frequency	Operating Temperature
BRM2722L-09-C BRM3214L-09-C	9	6 - 12	15 mA 6 mA	80dB @ 100cm 85dB @ 100cm	2 Leadwires 2 Leadwires	400 ± 50Hz 400 ± 50Hz	-20° to +60°C -20° to +60°C
Features 7 Songs, Play Continuously							
BRM2722L-09-CT BRM3214L-09-CT	9	6 - 12	15 mA 6 mA	80dB @ 100cm 85dB @ 100cm	3 Leadwires 3 Leadwires	400 ± 50Hz 400 ± 50Hz	-20° to +60°C -20° to +60°C
Features 7 Songs, Play Each Trigger							

BRM2722L Series

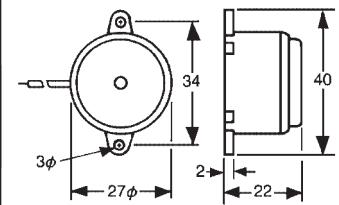

BRM3214L Series

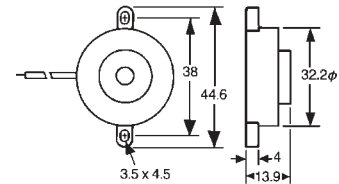

Electronic Chimes

Part Number	Rated Voltage (VDC)	Operating Voltage (VDC)	Current @ Rated Voltage	Sound Output Level	Terminal Type	Frequency	Operating Temperature
BRC3225L-12-C	12	6 - 18	125 mA	80dB @ 30cm	3 Leadwires	1050/850Hz	-20° to +55°C

BRC3225L-12-C

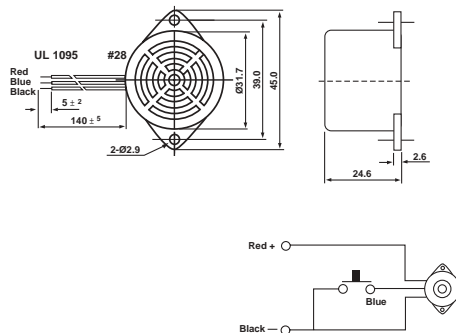

Piezo Speakers for Musical Cards

Part Number	Max Input Voltage	Lowest Resonant Frequency	Frequency Range	Capacitance (NF)	Impedance (OHM)	Operating Temperature	Termination
PS40L	30Vp-p	1,200 ± 200Hz	500 - 20,000Hz	65 ± 30% @ 120Hz	3500 @ 1KHz	-30° to +80°C	2 Leadwires

PS40L

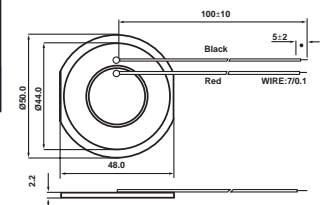

Piezo Ultrasonic Transducer

Part Number	Frequency Range	Resonant Frequency (KHz)	SPL Output (dB) @ 2.83 vrms Sine Wave @ 50cm	Rated Voltage (VRMS)	Max. Operating Voltage (VRMS)	Operating Temperature	Weight (grams)
BRPU5116T-30	2.5 - 60	22 ± 3.0	95/22 ± 1.0KHz	2.83 Sine Wave or (8Vp-p)	10 Sine Wave or (30Vp-p)	-20° to +70°C	10

BRP5116T Series

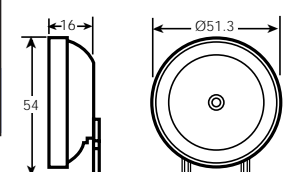

Miscellaneous Audible Signal Devices (continued)

Piezo Telephone Ringers - External Drive Types

Part Number	Max Input Voltage	Electrostatic Capacity (pF)	Sound Pressure Level (dB)	Terminal Type	Resonant Frequency (Hz)	Operating Temperature
BRP2309P-30-TR	30Vp-p	24,000 ± 30%	Min 85dB @ 10 cm	2 Pins	2048 ± 500	-20° to +70°C
BRP2503FL-40-TR	40Vp-p	35,000 ± 30%	Min 70dB @ 10 cm	2 Flying Wires	2000	-20° to +70°C
BRP3313L-30-TR	30Vp-p	50,000 ± 30%	Min 70dB @ 10 cm	2 Leadwires	900	-20° to +60°C
BRP3409L-40-TR	40Vp-p	40,000 ± 25%	Min 70dB @ 1M	2 Leadwires	1000	-20° to +70°C
BRP3409P-40-TR	40Vp-p	45,000 ± 30%	Min 80dB @ 30 cm	2 Pins	1200	-20° to +60°C
BRP4414L-30-TR	30Vp-p	75,000 ± 30%	Min 75dB @ 1M	2 Leadwires	1000	-20° to +70°C
BRP4417P-30-TR	30Vp-p	80,000 ± 30%	Min 70dB @ 10 cm	2 Pins	1000	-20° to +70°C

BRP2309P-30-TR

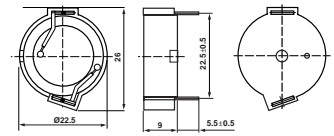

BRP2503FL-40-TR Series

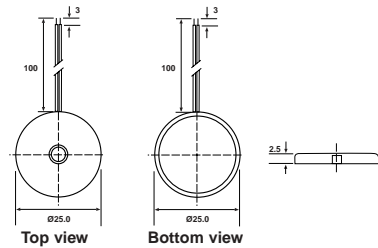

BRP3313L-30-TR Series

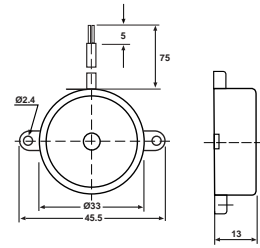

BRP3409L-40-TR Series

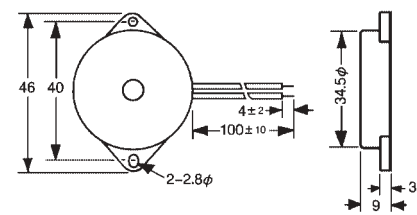

BRP3409P-40-TR Series

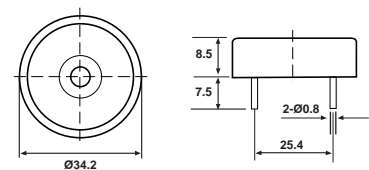

BRP4417P-30-TR Series

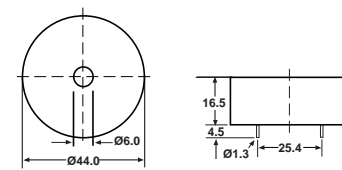

BRP4414L-30-TR Series

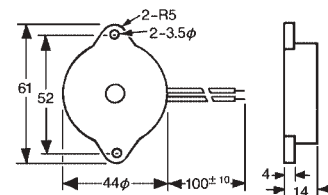

3-Tone Piezo Telephone Ringer

Part Number	Max Input Voltage	Working Frequencies For 3 Tone Call (Hz)	SPL Output dB @ 10cm @ Resonant Freq.	Terminal Type
BRP4815-30-TR	30Vp-p	F1 - 800 ± 10% F2 - 1067 ± 10% F3 - 1333 ± 10%	Min 82dB	4 Pins

BRP4815-30-TR Series

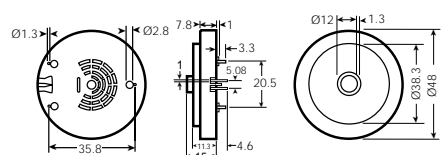

Piezo Sounders 100dB or Greater

External-Drive Sounder (no circuit)

Part Number	Max Input Voltage Vp-p	Electro-Static Capacitance	Max. Current (mA)	Min. Sound Output Level	Terminal Type	Tone Mode	Resonant Frequency	Operating Temperature
BPS5524SP-150	150	30,000pF ± 30%	47mA @ 125Vp-p	105dB @ 100cm	Solder Points	Continuous	3500 ± 500Hz	-20° to +60°C

BPS5524SP-150 Series

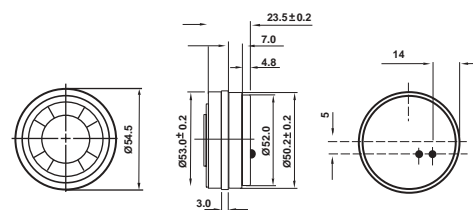

Miscellaneous Audible Signal Devices (continued)

AC Piezo Buzzers

Part Number	Rated Voltage (VAC)	Operating Voltage (VAC)	Max. Current (mA)	Sound Output Level	Terminal Type	Tone Mode Pulse/Second	Frequency	Operating Temperature
BRP2319L-110-C	110	96 - 144	5	75dB @ 30cm	2 Leadwires	Continuous	3300 ± 500Hz	-20° to +60°C
BRP2319P-110-C	110	96 - 144	5	75dB @ 30cm	2 Pins	Continuous	3300 ± 500Hz	-20° to +60°C
BRP2319L-220-C	220	176 - 264	5	75dB @ 30cm	2 Leadwires	Continuous	3300 ± 500Hz	-20° to +60°C
BRP2319P-220-C	220	176 - 264	5	75dB @ 30cm	2 Pins	Continuous	3300 ± 500Hz	-20° to +60°C
BRP4549S-12-CD	12	4 - 16	90	90/85dB @ 30cm	3 Screw Lugs	Cont/Intermitt 1:1	2900 ± 500Hz	-20° to +80°C
BRP4549S-24-CD	24	4 - 28	90	90/85dB @ 30cm	3 Screw Lugs	Cont/Intermitt 1:1	2900 ± 500Hz	-20° to +80°C
BRP4549S-110-C	110	30 - 120	20	90dB @ 30cm	2 Screw Lugs	Continuous	2900 ± 500Hz	-20° to +60°C
BRP4549S-240-C	240	60 - 250	20	90dB @ 30cm	2 Screw Lugs	Continuous	2900 ± 500Hz	-20° to +60°C
BRP4549S-110-CP	110	30 - 120	10	80dB @ 30cm	2 Screw Lugs	Intermitt: 0.8-1.2	2900 ± 500Hz	-20° to +60°C
BRP4549S-240-CP	240	60 - 250	10	80dB @ 30cm	2 Screw Lugs	Intermitt: 0.8-1.2	2900 ± 500Hz	-20° to +60°C

BRP2319L-C Series

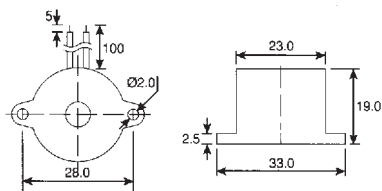

BRP2319P-C Series

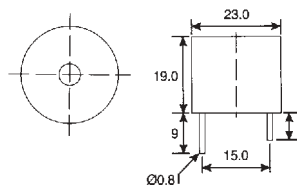

BRP4549S Series

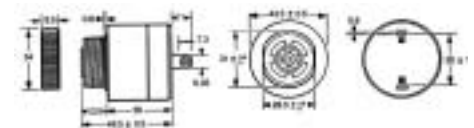

BRP4549S-CD Series

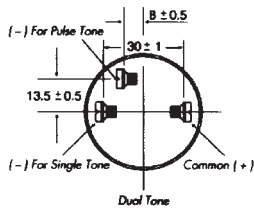

Volume Control for Panel Mount Series BRP4549

Part Number	VC45S	Includes Mounting Plate, Shutter and Screw
-------------	-------	--------------------------------------------

VC45S

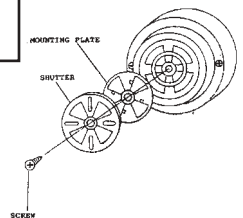

Electronic AC Buzzers

Part Number	Rated Voltage (VAC)	Operating Voltage (VAC)	Max Current (mA)	Sound Output	Terminal Type	Frequency	Operating Temperature
BS2315T-110-AC	110	70 - 150	25	75dB @ 10cm	Lugs	50 - 60Hz	-20° to +75°C*
BS2315T-220-AC	220	160 - 260	30	78dB @ 10cm	Lugs	50 - 60Hz	-25° to +110°C*
BS2319T-05-AC	5	4 - 10	78	85dB @ 30cm	Lugs	50 - 60Hz	-20° to +60°C
BS2319T-12-AC	12	8 - 18	78	85dB @ 30cm	Lugs	50 - 60Hz	-20° to +60°C
BS2319T-24-AC	24	16 - 32	78	85dB @ 30cm	Lugs	50 - 60Hz	-20° to +60°C
BS2319T-110-AC	110	80 - 130	78	85dB @ 30cm	Lugs	50 - 60Hz	-20° to +60°C
BS2319T-220-AC	220	180 - 260	78	85dB @ 30cm	Lugs	50 - 60Hz	-20° to +60°C
BS6126L-06-AC	6	4 - 11	50	70dB @ 30cm	UL 1007 Wires	50 - 60Hz	-20° to +60°C
BS6126L-12-AC	12	8 - 18	40	70dB @ 30cm	UL 1007 Wires	50 - 60Hz	-20° to +60°C
BS6126L-24-AC	24	19 - 32	33	74dB @ 30cm	UL 1007 Wires	50 - 60Hz	-20° to +60°C
BS6126L-110-AC	110	60 - 150	45	68dB @ 30cm	UL 1007 Wires	50 - 60Hz	-20° to +60°C
BS6126L-220-AC	220	160 - 250	40	70dB @ 30cm	UL 1007 Wires	50 - 60Hz	-20° to +60°C

*Max. Coil Temperature 130°C Installed in the Metal Plate 200x200x2mm

BS2315T-AC Series

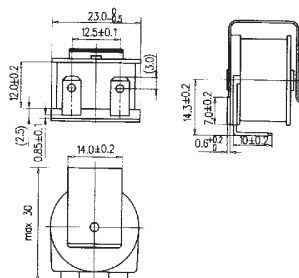

BS2319T-AC Series

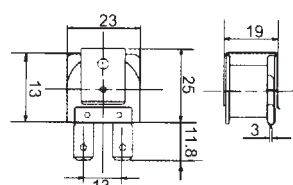

BS6126L-AC Series

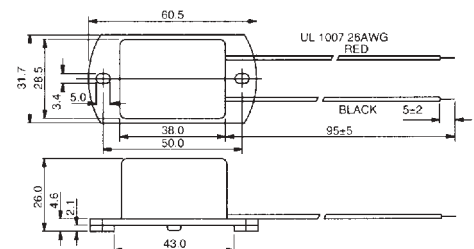

Electronic DC Buzzers

Part Number	Rated Voltage (VDC)	Operating Voltage (VDC)	Max Current (mA)	Sound Output	Terminal Type	Frequency	Operating Temperature
BS2316L-01	1.5	1.3 - 2	25 mA	75 @ 30cm dB	2 Leadwires	400 ± 50Hz	-40° to +70°C
BS2316L-03	3	2 - 5	25 mA	75 @ 30cm dB	2 Leadwires	400 ± 50Hz	-40° to +70°C
BS2316L-06	6	4 - 9	25 mA	75 @ 30cm dB	2 Leadwires	400 ± 50Hz	-40° to +70°C
BS2316L-09	9	6 - 15	25 mA	75 @ 30cm dB	2 Leadwires	400 ± 50Hz	-40° to +70°C
BS2316L-12	12	9 - 20	25 mA	75 @ 30cm dB	2 Leadwires	400 ± 50Hz	-40° to +70°C
BS2316L-24	24	10 - 27	25 mA	75 @ 30cm dB	2 Leadwires	400 ± 50Hz	-40° to +70°C
BS2316P-06-C	6	4 - 8	35 mA	80 @ 30cm dB	4 Pins	400 ± 50Hz	-40° to +70°C
BS2316P-09-C	9	6 - 12	35 mA	80 @ 30cm dB	4 Pins	400 ± 50Hz	-40° to +70°C
BS2316P-12-C	12	8 - 16	35 mA	80 @ 30cm dB	4 Pins	400 ± 50Hz	-40° to +70°C
BS2316P-24-C	24	16 - 27	35 mA	80 @ 30cm dB	4 Pins	400 ± 50Hz	-40° to +70°C
BS2620FV-03	3	2 - 4	70 mA	75 @ 100cm dB	2 Fast-on	400 ± 50Hz	-40° to +70°C
BS2620FV-06	6	4 - 8	70 mA	75 @ 100cm dB	2 Fast-on	400 ± 50Hz	-40° to +70°C
BS2620FV-12	12	8 - 16	60 mA	75 @ 100cm dB	2 Fast-on	400 ± 50Hz	-40° to +70°C
BS2620FV-24	24	20 - 28	60 mA	75 @ 100cm dB	2 Fast-on	400 ± 50Hz	-40° to +70°C
BS2620PH-03-C	3	2 - 4	30 mA	75 @ 100cm dB	4 Pins	400 ± 50Hz	-40° to +70°C
BS2620PH-06-C	6	4 - 8	30 mA	75 @ 100cm dB	4 Pins	400 ± 50Hz	-40° to +70°C
BS2620PH-12-C	12	8 - 16	20 mA	75 @ 100cm dB	4 Pins	400 ± 50Hz	-40° to +70°C
BS2620PH-24-C	24	20 - 28	20 mA	75 @ 100cm dB	4 Pins	400 ± 50Hz	-40° to +70°C
BR2818L-01	1.5	1.3 - 2	35 mA	80 @ 30cm dB	2 Leadwires	400 ± 50Hz	-40° to +70°C
BR2818L-03	3	2 - 5	35 mA	80 @ 30cm dB	2 Leadwires	400 ± 50Hz	-40° to +70°C
BR2818L-06	6	4 - 9	35 mA	80 @ 30cm dB	2 Leadwires	400 ± 50Hz	-40° to +70°C
BR2818L-09	9	6 - 15	35 mA	80 @ 30cm dB	2 Leadwires	400 ± 50Hz	-40° to +70°C
BR2818L-12	12	9 - 20	35 mA	80 @ 30cm dB	2 Leadwires	400 ± 50Hz	-40° to +70°C
BR2818L-24	24	20 - 28	35 mA	85 @ 30cm dB	2 Leadwires	400 ± 50Hz	-40° to +70°C
BR2818L-48	48	30 - 54	35 mA	85 @ 30cm dB	2 Leadwires	400 ± 50Hz	-40° to +70°C

BS2316 Series

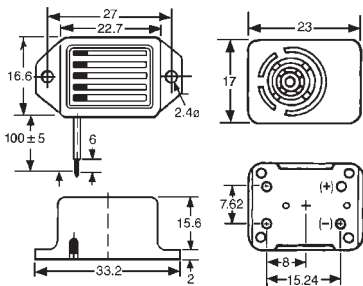

BS2620FV Series

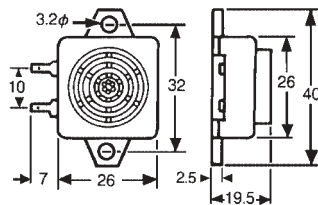

BS2620PH Series

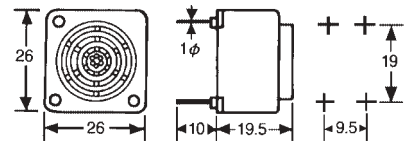

BR2818 Series

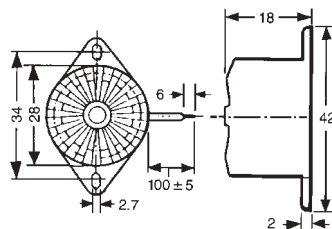

Piezo Elements

Piezo Elements – Series BPE

Part Number	Resonant Frequency (KHz)	Resonant Impedance (Ohm)	Capacitance (pF @ 1KHz)	Input Voltage (Vp-p max)	D (mm)	T (mm)
BPE12B-11	11	1500	3300	30	12	0.33
BPE12B-16.5	16.5	800	6000	30	12	0.40
BPE15B-10	10	600	9000	30	15	0.40
BPE15B-12	12	600	8000	30	15	0.40
BPE20S-6.5	6.5	500	12000	30	20	0.40
BPE20B-4.5	4.5	300	15000	30	20	0.30
BPE20B-6.5	6.5	500	14000	30	20	0.45
BPE20B-6.8	6.8	500	19000	30	20	0.43
BPE22.5B-5.5	5.5	1000	12000	30	22.5	0.43
BPE27S-4	4.0	500	20000	30	27	0.45
BPE27S-4.6	4.6	500	25000	30	27	0.45
BPE27B-3.6	3.6	500	25000	30	27	0.45
BPE27B-3.8	3.8	1000	11000	30	27	0.53
BPE27B-4.2	4.2	500	20000	30	27	0.53
BPE27B-4.6	4.6	300	20000	30	27	0.50
BPE32B-2.8	2.8	300	30000	30	32	0.43
BPE35S-2.9	2.9	200	35000	30	35	0.53
BPE35B-1.8	1.8	250	45000	30	35	0.38
BPE35B-2.6	2.6	200	30000	30	35	0.47
BPE35B-3.2	3.2	300	17000	30	35	0.63
BPE43B-3.4	3.4	300	30000	30	43	0.45
BPE50B-1	1.0	500	50000	30	50	0.43
BPE50B-3	3.0	400	40000	30	50	0.43
BPE50B-3.9	3.9	300	17000	30	50	0.63

BPE/BPET Series

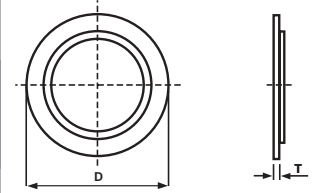

Piezo Elements – Series BPET

Part Number	Resonant Frequency (KHz)	Resonant Impedance (Ohm)	Capacitance (pF @ 1KHz)	Input Voltage (Vp-p max)	D (mm)	T (mm)
BPET12S-4.9	4.9	700	12000	30	12	0.12
BPET12B-7.5	7.5	700	8000	30	12	0.18
BPET12B-9.5	9.5	1300	8000	30	12	0.22
BPET15S-6	6.0	1000	11000	30	15	0.23
BPET15B-6	6.0	600	15000	30	15	0.23
BPET15B-7.7	7.7	700	7000	30	15	0.32
BPET18B-3.6	3.6	1000	12000	30	18	0.23
BPET20S-2.5	2.5	200	85000	30	20	0.12
BPET20B-2.5	2.5	200	85000	30	20	0.12
BPET20S-3.6	3.6	300	28000	30	20	0.22
BPET20B-3.6	3.6	300	28000	30	20	0.22
BPET20B-3.9	3.9	200	35000	40	20	0.22
BPET27S-2.3	2.3	300	45000	30	27	0.23
BPET27B-1.8	1.8	1000	36000	30	27	0.23
BPET27B-2.3	2.3	300	45000	30	27	0.23
BPET31B-1.6	1.6	300	50000	30	31	0.23
BPET31B-1.8	1.8	200	75000	30	31	0.23
BPET31B-2	2.0	150	130000	30	31	0.23
BPET32S-1.6	1.6	200	65000	30	32	0.23
BPET32S-2.5	2.5	200	65000	30	32	0.23
BPET35B-1.3	1.3	200	75000	30	35	0.23
BPET40B-1.4	1.4	1000	100000	30	40	0.23
BPET41S-2.5	2.5	400	75000	30	41	0.23
BPET41B-1	1.0	1000	75000	30	41	0.23
BPET41B-2.5	2.5	400	75000	30	41	0.23
BPET43S-1.3	1.3	300	80000	30	43	0.33
BPET43B-0.8	0.8	1000	75000	30	43	0.23
BPET43B-1.3	1.3	300	80000	30	43	0.33
BPET43B-2	2.0	300	80000	30	43	0.22
BPET50B-1.9	1.9	300	112000	30	50	0.28

BPE/BPET Series

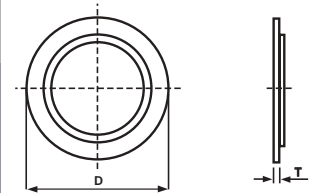

Piezo Elements – Series BPEF/BPEFT

Part Number	Resonant Frequency (KHz)	Resonant Impedance (Ohm)	Capacitance (pF @ 1KHz)	Input Voltage (Vp-p max)	D (mm)	T (mm)
BPEF20B-6.5	6.5	500	12000	30	20	0.42
BPEF27B-3.6	3.6	500	20000	30	27	0.45
BPEF27B-4.2	4.2	500	18000	30	27	0.48
BPEF32S-2.8	2.8	600	28000	30	32	0.38
BPEFR32B-3	3.0	300	30000	30	32	0.43
BPEF35S-2.9	2.9	200	28000	30	35	0.53
BPEF35S-3.2	3.2	200	25000	30	35	0.55
BPEFR35S-3.2	3.2	150	30000	30	35	0.53
BPEF35S-3.3	3.3	200	40000	30	35	0.55
BPEF35B-2.3	2.3	200	30000	30	35	0.43
BPEF35B-2.6	2.6	300	25000	30	35	0.45
BPEFT12S-4.5	4.5	700	10000	30	12	0.12
BPEFT12S-4.9	4.9	700	12000	30	12	0.12
BPEFT12S-7.5	7.5	1000	6000	30	12	0.18
BPEFT12B-4.5	4.5	700	10000	30	12	0.12
BPEFT12B-7.5	7.5	1000	6000	30	12	0.18
BPEFT15B-5.5	5.5	1500	12000	30	15	0.23
BPEFT15B-6.6	6.6	500	15000	30	15	0.22
BPEFT18B-3.5	3.5	1000	12000	30	18	0.23
BPEFT20B-3.6	3.6	300	24000	30	20	0.23
BPEFT20B-4	4.0	300	20000	30	20	0.24
BPEFT20B-4.5	4.5	300	14000	30	20	0.26
BPEFT21S-4	4.0	400	15000	30	21	0.25
BPEFT27B-2.3	2.3	300	40000	30	27	0.23
BPEFT27B-2.6	2.6	1200	36000	30	27	0.33
BPEFT50B-0.8	0.8	200	160000	30	50	0.23

BPEF/BPEFT Series

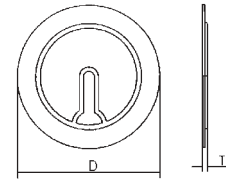

Piezo Elements – Series BPEDN/BPED

Part Number	Resonant Frequency (KHz)	Resonant Impedance (Ohm)	Capacitance (pF @ 1KHz)	Input Voltage (Vp-p max)	D (mm)	T (mm)
BPEDN21B-3.8	3.8	150	80000	30	21	0.28
BPEDN21B-4	4.0	150	80000	30	21	0.33
BPEDN21B-5.5	5.5	300	70000	30	21	0.50
BPED23B-3.8	3.8	150	80000	30	23	0.33
BPEDN24B-3.8	3.8	150	110000	30	24	0.33
BPED27B-2.8	2.8	150	80000	30	27	0.33
BPEDN27B-2.8	2.8	150	130000	30	27	0.33
BPED29B-2.8	2.8	100	130000	30	29	0.33
BPED31B-1.6	1.6	150	100000	30	31	0.33
BPED31B-2.5	2.5	100	130000	30	31	0.33
BPED33B-2	2.0	150	130000	30	33	0.33
BPED35B-3.2	3.2	100	130000	30	35	0.35
BPED37.6B-3	3.0	100	130000	30	37.6	0.35
BPED40B-3	3.0	100	130000	30	40	0.33
BPED41B-1.3	1.3	150	150000	30	41	0.40

BPEDN Series

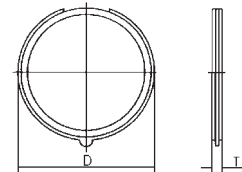

BPED Series

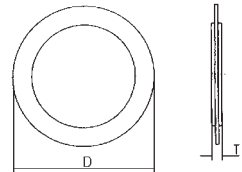

Speakers

- General Purpose Speakers [26](#)
- Telecommunications Speakers [26-27](#)
- Shielded Low Voltage Speakers [27-28](#)
- Micro Miniature Low Profile Speakers [28-29](#)
- Subminiature Low Profile Speakers [29-30](#)
- PC Mount Speakers [31](#)
- Surface Mount Speakers [31](#)

Big sound at a small price

Intervox miniature speakers offer outstanding value to applications such as telecommunications, security, computers/peripherals and general instrumentation. We offer a complete range of speakers designed to deliver outstanding sound quality in the smallest of spaces.

Surface Mount Speakers



Intervox introduced the first miniature SMT speaker weighing just 2.6 grams and measuring 20mm x 20mm x 5mm. The speaker is designed with materials suitable to withstand I.R. reflow.

Miniature General Purpose



This category consists of a wide variety of speakers – ranging in size from 1" to 4" in diameter – for voice or tone reproduction. They are available in round, square or oval shaped frames.

Telecommunications



These speakers are specifically designed for telephone handsets. Durably constructed, they are available with shielded or unshielded magnets as required. Some have setback flange mounting while others are spring loaded to eliminate the need for soldering.

Shielded Low Leakage



Designed for multimedia PC and television applications, these speakers feature specially constructed magnets and shields to eliminate leakage that can change monitors, floppy disks and other data storage equipment. Available in round, square and oval designs, for voice or music reproduction. Their size permits use in speaker boxes providing excellent high fidelity sound.

Micro-Miniature Low Profile (Height less than 5.0mm)



Due to the demand for handheld computers and other portable devices, Intervox has designed a series of speakers that have a height of less than 5.0mm. In fact, some speakers in this category have a profile as low as 2.2mm. The cone material is a durable mylar.

Sub-Miniature Low Profile (Height more than 5.0mm)



If you require wider frequency ranges and high power ratings, yet want to maintain a low profile, these speakers are an excellent choice. The cone material is available in paper and mylar.

PC Board Mounted



These speakers are designed to be plugged into printed circuit boards and are ideally suited for computer and modem applications.

General Purpose Speakers*

Round Metal Frame Types

Part Number	Frame Diameter (mm)	Frame Depth (mm)	Rated Power (watts)		Resonant Frequency (Hz)	Frequency Response (Hz)	SPL (dB)	Net Weight (Ounces)
			Nom.	Max.				
S150RN	40.0	15.8	0.25	0.5	600 ± 20%	Fo ~ 5000	83	0.79
S175RN	45.0	16.6	0.25	0.5	600 ± 20%	Fo ~ 5000	83	0.87
S200RN	50.0	18.0	0.25	0.5	550 ± 20%	Fo ~ 5000	83	1.36
S225RN	57.0	19.0	0.25	0.5	400 ± 20%	Fo ~ 5000	84	1.41
S250RN	65.0	21.4	0.5	1.0	380 ± 20%	Fo ~ 5000	84	1.51
S275RN	70.0	21.8	0.5	1.0	330 ± 20%	Fo ~ 6000	84	1.61
S300RN	77.0	23.2	0.5	1.0	250 ± 20%	Fo ~ 6000	84	1.98
S350RN	90.0	27.3	1.0	3.0	200 ± 20%	Fo ~ 8000	86	2.04
S400RN	100.0	33.8	1.0	3.0	150 ± 20%	Fo ~ 10000	86	2.40

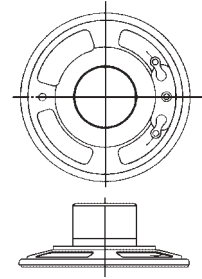

Square Metal Frame Types

Part Number	Frame Diameter (mm)	Frame Depth (mm)	Rated Power (watts)		Resonant Frequency (Hz)	Frequency Response (Hz)	SPL (dB)	Net Weight (Oz)	Mounting Dimensions Dia. (mm)
			Nom.	Max.					
S200SN	50.0	18.0	0.2	0.4	450 ± 20%	Fo ~ 5000	84	1.46	56.5
S250SN	65.0	21.4	1.0	2.0	350 ± 20%	Fo ~ 5000	84	1.65	75.0
S300SN	77.0	25.0	1.0	2.0	250 ± 20%	Fo ~ 6000	84	1.98	84.5
S350SN	90.0	27.0	2.0	3.0	200 ± 20%	Fo ~ 8000	86	2.04	105.0
S400SN	100.0	33.6	3.0	5.0	160 ± 20%	Fo ~ 10000	86	2.59	114.0

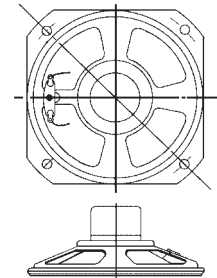

Telecommunications Speakers

Receivers

Part Number	Frame Diameter (mm)	Frame Depth (mm)	Rated Power (mW)		Voice Coil Impedance (Ohms)	Frequency Response (Hz)	SPL (dB)	Magnet Type	Net Weight (Ounces)
			Nom.	Max.					
DR1002RF-32	10.0	2.4	5	10	32 ± 15%	300 ~ 3500	113	Ferrite	0.6
DR1303RF-32	12.9	2.5	20	40	32 ± 15%	300 ~ 3500	116	Ferrite	1.0
DR1305RF-32-SPG	13.0	5.2	10	20	32 ± 15%	200 ~ 3500	101	Ferrite	1.3
DR1407RF-100	13.6	6.6	20	40	100 ± 15%	200 ~ 3800	104	Ferrite	2.0
DR1506RF-32-SPG	15.0	5.7	1	2	32 ± 15%	300 ~ 3400	106	Ferrite	1.1
DR2114RF-150	21.0	14.2	20	40	150 ± 15%	300 ~ 5000	105	Ferrite	6.0

DR1002RF-32

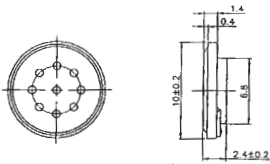

DR1303RF-32

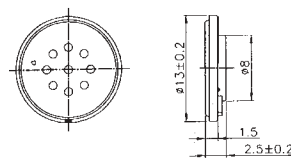

DR1305RF-32-SPG

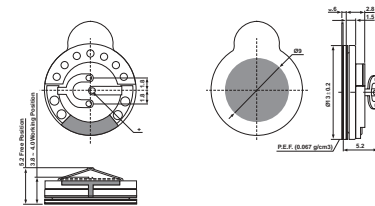

DR1407RF-100

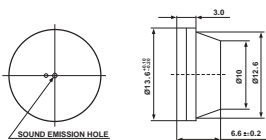

DR1506RF-32-SPG

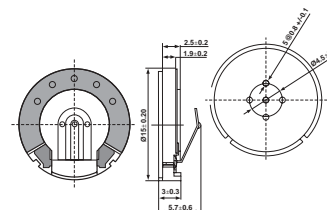

DR2114RF-150

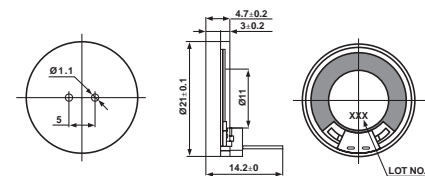

*Standard voice coil impedance 8 ohms ± 15%. These speakers can be supplied with a variety of voice coil impedances. The most common impedances are 4, 16, 32, 45 and 100 ohms.

Telecommunications Speakers (continued)

Unique Round Frame Design*

Part Number	Frame Diameter (mm)	Frame Depth (mm)	Rated Power (watts)		Voice Coil Impedance (Ohms)	Resonant Response (Hz)	Frequency Response (dB)	SPL (dB)	Magnet	Net Weight (Ounces)
			Nom.	Max.						
S200RA-MB	50	18.7	0.2	0.4	8 ± 15%	500 ± 20%	Fo ~ 4500	84	Alnico	1.51

S200RA-MB

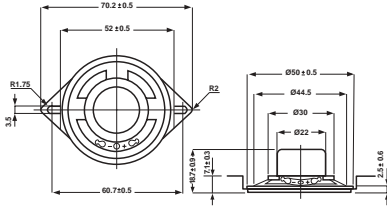

Shielded Low Leakage Speakers* For Computer and TV Applications, etc.

Plastic Oval Frame Types

Part Number	Frame Diameter (mm)	Frame Depth (mm)	Rated Power (watts)		Resonant Frequency (Hz)	Frequency Response (Hz)	SPL (dB)	Cone Material	Net Weight (Ounces)	Mounting Dimensions Dia. (mm)
			Nom.	Max.						
SR55X10VN	14 x 25	5.2	1.0	1.5	600 ± 20%	Fo ~ 4000	81	Paper	0.08	11 x 22
SR60X14VNS	16 x 35	4.2	1.0	1.5	650 ± 20%	Fo ~ 4000	82	Paper	0.07	13 x 31
SR60X14VN	16 x 35	8	1.0	2.0	550 ± 20%	Fo ~ 13000	84	Paper	0.15	12 x 31
SR80X14VNS	20 x 35	5.3	1.0	1.5	590 ± 20%	Fo ~ 20000	86	Plastic	0.15	16 x 31
SR80X16VN	20 x 40	5.3	0.5	1.0	550 ± 20%	Fo ~ 20000	83	Plastic	0.15	16 x 36
S11X16VN-2W	28.5 x 40	13.0	2.0	4.0	350 ± 20%	Fo ~ 20000	89	Paper	0.58	22 x 33.5
S11X16VNS-2W	28.5 x 40	11.3	2.0	3.0	350 ± 20%	Fo ~ 20000	83	Paper	0.42	22 x 33.5
S11X16VNS	28.5 x 40	11.3	1.0	2.0	390 ± 20%	Fo ~ 20000	82	Paper	0.42	22 x 33.5

Metal Oval Frame Types

Part Number	Frame Diameter (mm)	Frame Depth (mm)	Rated Power (watts)		Resonant Frequency (Hz)	Frequency Response (Hz)	SPL (dB)	Cone Material	Net Weight (Ounces)	Mounting Dimensions Dia. (mm)
			Nom.	Max.						
S15X25VA	40 x 70	29.8	3.0	5.0	280 ± 20%	Fo ~ 15000	82	Paper	1.90	33.4 x 63.4
S20X35VFS-2W	50 x 90	36.5	3.0	5.0	200 ± 20%	Fo ~ 20000	83	Paper	3.93	40 x 75
S20X35VFS-5W	50 x 90	41.6	5.0	8.0	200 ± 20%	Fo ~ 20000	90	Paper	3.93	40 x 75

Plastic Oval Frame Types

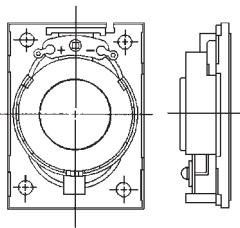

S15X25VA

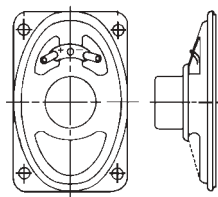

S20X35VFS Series

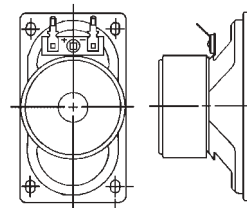

*Standard voice coil impedance 8 ohms ± 15%. These speakers can be supplied with a variety of voice coil impedances. The most common impedances are 4, 16, 32, 45 and 100 ohms.

Shielded Low Leakage Speakers* (continued)

Metal Round Frame Types

Part Number	Frame Diameter (mm)	Frame Depth (mm)	Rated Power (watts)		Resonant Frequency (Hz)	Frequency Response (Hz)	SPL (dB)	Cone Material	Net Weight (Ounces)
			Nom.	Max.					
S200RFS-2W	50	30.0	2.0	3.0	220 ± 20%	Fo ~ 20000	82	Paper	3.50
S300RFS-3W	77	35.2	3.0	5.0	200 ± 20%	Fo ~ 15000	82	Paper	4.07
S400RFS-3W	102	44.8	3.0	5.0	140 ± 20%	Fo ~ 20000	87	Paper	7.39
S400RFS-5W	102	47.5	5.0	8.0	140 ± 20%	Fo ~ 12000	85	Paper	14.70
S500RFS-4W	119	53.2	4.0	6.0	130 ± 20%	Fo ~ 10000	87	Paper	12.28

S200RFS

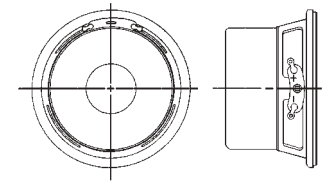

S300RFS

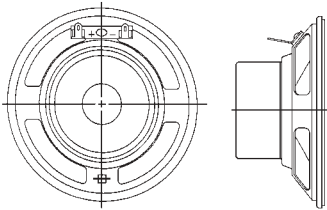

S400RFS Series

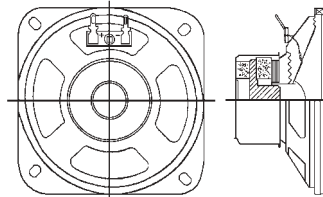

S500RFS

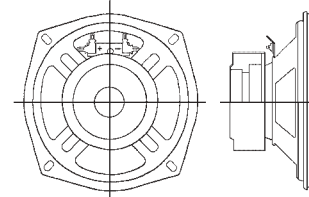

Micro-Miniature Low Profile Speakers*

Height Less Than 5.0 mm

Round Metal Frame Types

Part Number	Frame Diameter (mm)	Frame Depth (mm)	Rated Power (Watts)		Cone Material	Resonant Frequency (Hz)	Frequency Response (Hz)	SPL (dB)	Magnet Type	Net Weight (Grams)
			Nom.	Max.						
SR500RS-M	13.6	4.6	0.05	0.1	Mylar	1000 ± 20%	Fo ~ 20000	83	Rare Earth	1.6
SR600RS-M	15	3.5	0.3	0.5	Mylar	780 ± 20%	Fo ~ 5000	78	Rare Earth	1.8
SR600RSL-M	15	2.2	0.1	0.2	Mylar	760 ± 20%	Fo ~ 5000	70	Rare Earth	1.2
SR630RS-M	16	3.8	0.2	0.4	Mylar	650 ± 20%	Fo ~ 6000	73	Rare Earth	1.6
SR800RS-M	20	2.4	0.3	0.6	Mylar	490 ± 20%	Fo ~ 6000	76	Rare Earth	2.1
SR800RS-M-1	20	3.2	0.5	1.0	Mylar	650 ± 20%	Fo ~ 20000	78	Rare Earth	2.8
SR800RS-M-2	20	4.0	0.5	1.0	Mylar	850 ± 20%	Fo ~ 9000	82	Rare Earth	2.6
S100RS-M	26	4.4	0.5	1.0	Mylar	540 ± 20%	Fo ~ 20000	83	Rare Earth	4.6
S110RS-M-R5W	28	4.8	0.5	1.0	Mylar	530 ± 20%	Fo ~ 20000	82	Rare Earth	4.8
S110RMSS	28	4.7	0.5	1.0	Mylar	630 ± 20%	Fo ~ 11000	83	Rare Earth	4.8
S125RSL-M-R5W	30	4.0	0.5	1.0	Mylar	650 ± 20%	Fo ~ 3000	87	Rare Earth	5.6
S125RS-M-R5W	32	4.6	0.5	1.0	Mylar	600 ± 20%	Fo ~ 5000	87	Rare Earth	7
S150RS-M-R5W	36	4.8	0.5	1.0	Mylar	550 ± 20%	Fo ~ 6000	87	Rare Earth	7.5
S150RS-M	36	4.8	0.2	0.5	Mylar	480 ± 20%	Fo ~ 12000	80	Rare Earth	7.5
S160RS-M-R2W	40	4.9	0.2	0.4	Mylar	350 ± 20%	Fo ~ 6000	83	Rare Earth	9.2
S160RS-M-1W	40	4.9	1.0	1.5	Mylar	430 ± 20%	Fo ~ 5000	84	Rare Earth	9.2

SR800RS-M-2

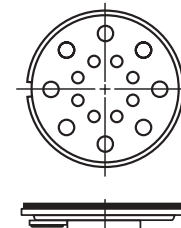

All Others

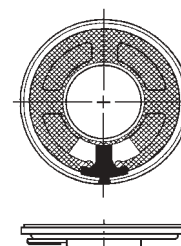

*Standard voice coil impedance 8 ohms ± 15%. These speakers can be supplied with a variety of voice coil impedances. The most common impedances are 4, 16, 32, 45 and 100 ohms.

Micro-Miniature Low Profile Speakers* (continued)

Round Plastic Frame Types

Part Number	Frame Diameter (mm)	Frame Depth (mm)	Rated Power (Watts)		Cone Material	Resonant Frequency (Hz)	Frequency Response (Hz)	SPL (dB)	Net Weight (Grams)
			Nom.	Max.					
SR430RMSS	11	4.3	0.07	0.1	Mylar	850 ± 20%	Fo ~ 10000	74	1.2
SR800RMS	20	4.2	0.1	0.2	Mylar	800 ± 20%	Fo ~ 5300	71	1.7
S100RMSS	28	3.9	0.1	0.2	Mylar	500 ± 20%	Fo ~ 6300	78	2.9
S100RMSS-R2W	28	4.3	0.2	0.3	Mylar	850 ± 20%	Fo ~ 5600	82	2.9
S125RMSS	30	3.9	0.2	0.3	Mylar	500 ± 20%	Fo ~ 6000	80	2.9
S150RMSS	36	3.8	0.1	0.2	Mylar	420 ± 20%	Fo ~ 6000	82	4.6
S150RMSS-R2W	36	4.0	0.2	0.4	Mylar	530 ± 20%	Fo ~ 7000	82	4.6
S150RMSS-R3W	38	4.2	0.3	0.6	Mylar	380 ± 20%	Fo ~ 20000	80	6
S160RMSS	40	4.4	0.3	0.6	Mylar	420 ± 20%	Fo ~ 5000	84	6.8
S160RMSS-R5W	40	4.1	0.5	1.0	Mylar	460 ± 20%	Fo ~ 20000	86	5.7

S160RMSS-R5W

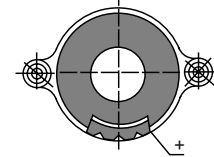

All Others

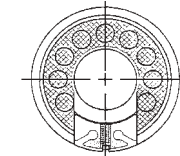

Square Plastic Frame Types

Part Number	Frame Diameter (mm)	Frame Depth (mm)	Rated Power (Watts)		Cone Material	Resonant Frequency (Hz)	Frequency Response (Hz)	SPL (dB)	Net Weight (Grams)	Mounting Dimensions Dia. (mm)
			Nom.	Max.						
S100SLA	27 x 23	3.7	0.5	1.0	Mylar	650 ± 20%	Fo ~ 20000	78	2.8	18 x 22
S125SLA	32 x 32	4.5	0.2	0.4	Mylar	800 ± 20%	Fo ~ 7000	80	3.6	37.5
S150SLA	40 x 40	4.5	0.2	0.3	Mylar	550 ± 20%	Fo ~ 8000	82	5.8	46.8
S150SLA-R5W	40 x 40	4.8	0.5	1.0	Mylar	550 ± 20%	Fo ~ 10000	89	9.0	46.8

S100SLA

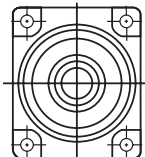
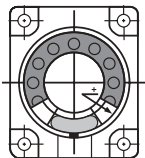

All Others

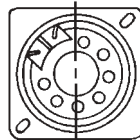
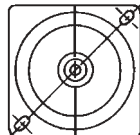

Sub-Miniature Low Profile Speakers*

Height 5.0 mm and Up

Round Metal Frame Types

Part Number	Frame Diameter (mm)	Frame Depth (mm)	Rated Power (Watts)		Cone Material	Resonant Frequency (Hz)	Frequency Response (Hz)	SPL (dB)	Net Weight (Grams)
			Nom.	Max.					
SR900RL-M	23	5.4	0.5	1.0	Mylar	670 ± 20%	Fo ~ 20000	80	4
S125RL-M	30	5.0	0.5	1.0	Mylar	600 ± 20%	Fo ~ 6500	86	5.6
S150RLS	38	8.0	0.1	0.2	Paper	700 ± 20%	Fo ~ 3000	85	10.4
S150RL-R2W	40	8.2	0.25	0.5	Paper	530 ± 20%	Fo ~ 4700	81	10.2
S160RL	40	5.0	1.0	2.0	Paper	430 ± 20%	Fo ~ 6500	90	9.4
S175RL	45	8.3	0.1	0.2	Paper	470 ± 20%	Fo ~ 4500	82	11.8
S200RL	50	8.8	0.25	0.5	Paper	450 ± 20%	Fo ~ 4000	84	12.8
S200RL-R2W	50	8.8	0.25	0.5	Paper	480 ± 20%	Fo ~ 4000	87	12.8
S200RL-M-R3W	50	7.5	0.3	0.6	Mylar	400 ± 20%	Fo ~ 5000	85	13.1
S225RL	57	9.7	0.3	0.5	Paper	390 ± 20%	Fo ~ 3800	93	14.8

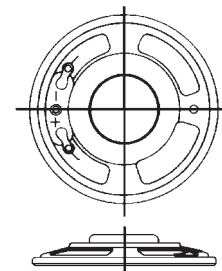

*Standard voice coil impedance 8 ohms ± 15%. These speakers can be supplied with a variety of voice coil impedances. The most common impedances are 4, 16, 32, 45 and 100 ohms.

Sub-Miniature Low Profile Speakers* (continued)

Round Plastic Frame Types

Part Number	Frame Diameter (mm)	Frame Depth (mm)	Rated Power (Watts)		Cone Material	Resonant Frequency (Hz)	Frequency Response (Hz)	SPL (dB)	Magnet Type	Net Weight (Grams)
			Nom.	Max.						
SR800RMF	20	9.0	0.1	0.2	Mylar	750 ± 20%	Fo ~ 3000	77	Ferrite	7.4
S100RMF	27	9.0	0.1	0.2	Mylar	800 ± 20%	Fo ~ 5000	80	Ferrite	7.6
S125RMF	29	10.0	0.1	0.2	Mylar	760 ± 20%	Fo ~ 3500	80	Ferrite	8.3
S125RMFL	29	6.0	0.1	0.2	Mylar	670 ± 20%	Fo ~ 6000	80	Ferrite	8.2
S150RMF	40	8.7	0.1	0.2	Mylar	250 ± 20%	Fo ~ 5500	75	Ferrite	16.0
S100RMS	28	7.2	0.5	0.8	Mylar	680 ± 20%	Fo ~ 5500	88	Rare Earth	9.8
S125RMS	30	7.3	0.4	0.8	Mylar	650 ± 20%	Fo ~ 10000	88	Rare Earth	9.8
S160RMS-B	40	5.3	0.5	1.0	Mylar	420 ± 20%	Fo ~ 5500	87	Rare Earth	6.8
S200RMS	50	8.0	0.2	0.4	Mylar	350 ± 20%	Fo ~ 10000	80	Rare Earth	11.0
S225RMS	57	8.0	0.2	0.4	Mylar	350 ± 20%	Fo ~ 6000	80	Rare Earth	12.0

S160RMS-B

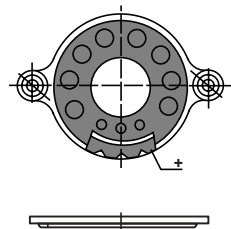

Rare Earth

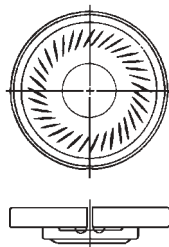

Ferrite

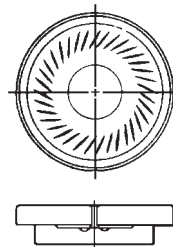

Square Metal Frame Types

Part Number	Frame Diameter (mm)	Frame Depth (mm)	Rated Power (Watts)		Cone Material	Resonant Frequency (Hz)	Frequency Response (Hz)	SPL (dB)	Magnet Type	Net Weight (Grams)	Mounting Dimensions Dia. (mm)
			Nom.	Max.							
S160SL	40 x 40	9.0	0.2	0.3	Paper	550 ± 20%	Fo ~ 6700	80	Rare Earth	10.4	34.5 x 34.5
S200SL	50 x 50	10	0.3	0.6	Paper	480 ± 20%	Fo ~ 6000	81	Rare Earth	12.8	40 x 40

Square Plastic Frame Types

Part Number	Frame Diameter (mm)	Frame Depth (mm)	Rated Power (Watts)		Cone Material	Resonant Frequency (Hz)	Frequency Response (Hz)	SPL (dB)	Magnet Type	Net Weight (Grams)	Mounting Dimensions Dia. (mm)
			Nom.	Max.							
S110SL	28 x 28	10.8	2.0	3.0	Mylar	270 ± 20%	Fo ~ 20000	82	Rare Earth	15	22.6 x 22.6

S160SL

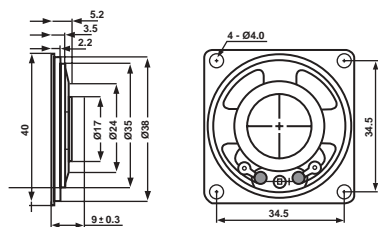

S200SL

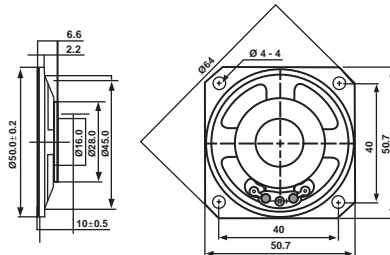

S110SL

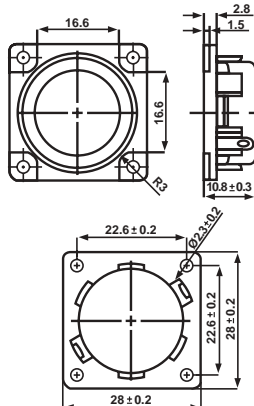

*Standard voice coil impedance 8 ohms ± 15%. These speakers can be supplied with a variety of voice coil impedances. The most common impedances are 4, 16, 32, 45 and 100 ohms.

PC Mount Speakers*

Round Plastic Frame Types

Part Number	Frame Diameter (mm)	Frame Depth (mm)	Rated Power (Watts)		Cone Material	Resonant Frequency (Hz)	Frequency Response (Hz)	SPL (dB)	Magnet Type	Net Weight (Grams)	Termination & Spacing
			Nom.	Max.							
SR900R-PC	23	8.7	0.1	0.2	Mylar	850 ± 20%	Fo ~ 3500	89	Rare Earth	3.6	2 Pins - 10mm
S100RMF-PCR	27	8.8	0.1	0.2	Mylar	670 ± 20%	Fo ~ 7000	78	Rare Earth	7.8	2 Pins - 5mm
S110R-PC	30	12.0	0.15	0.2	Mylar	1000 ± 20%	Fo ~ 5500	82	Rare Earth	10.0	2 Pins - 15mm
S125R-PC	32	15.0	0.15	0.2	Mylar	1100 ± 20%	Fo ~ 4000	83	Rare Earth	12.9	2 Pins - 17.5mm

Square Plastic Frame Types

Part Number	Frame Diameter (mm)	Frame Depth (mm)	Rated Power (Watts)		Cone Material	Resonant Frequency (Hz)	Frequency Response (Hz)	SPL (dB)	Magnet Type	Net Weight (Grams)	Termination & Spacing
			Nom.	Max.							
S150SL-PC	39.6 x 42.5	4.8	0.25	0.5	Mylar	450 ± 20%	Fo ~ 5000	83	Rare Earth	7.8	2 Pins - 4.5mm

SR900R-PC

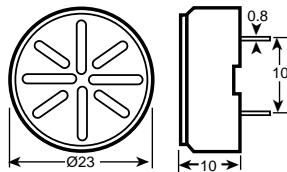

S100RMF-PCR

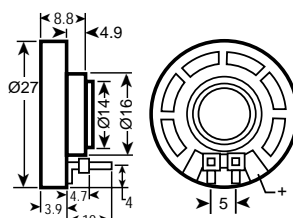

S110R-PC

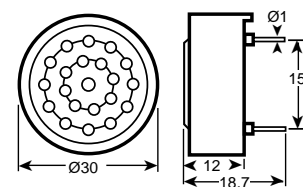

S125R-PC

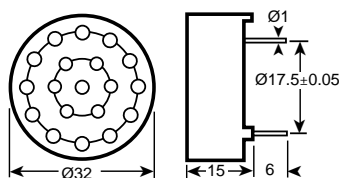

S150SL-PC

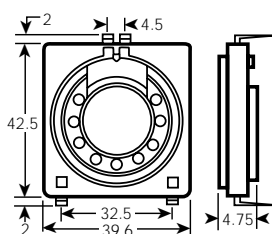

Surface Mount Speakers*

Surface Mount Speakers

Part Number	Frame Diameter (mm)	Frame Depth (mm)	Rated Power (Watts)		Cone Material	Resonant Frequency (Hz)	Frequency Response (Hz)	SPL (dB)	Magnet Type	Net Weight (Grams)
			Nom.	Max.						
SR800SMT	20	5.0	0.1	0.2	Mylar	1000 ± 20%	Fo ~ 11000	74	Rare Earth	2.6

SR800SMT

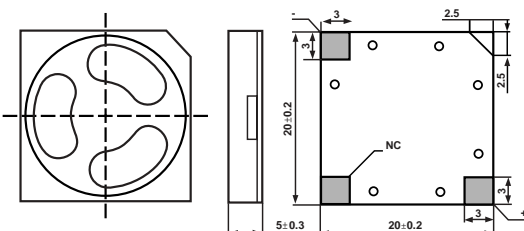

*Standard voice coil impedance 8 ohms ± 15%. These speakers can be supplied with a variety of voice coil impedances. The most common impedances are 4, 16, 32, 45 and 100 ohms.

Microphones

Electret Condenser Microphones

Omnidirectional [33](#)

Unidirectional [33](#)

Noise Cancelling [33](#)

Without Fet Impedance Converter [34](#)

Grommets [34](#)

PC Mounting Devices [34](#)

Microphones that speak to your needs
Intervox electret condenser microphones meet the demanding needs of applications such as telecommunications, voice recognition and sound sensory devices.

Elements



Intervox electret condenser microphone line consists of a diversified range of products that include omnidirectional, unidirectional and noise cancelling types. By using the finest materials these microphones meet the demands of today's telecommunications, voice recognition and sensory device applications.

These microphones are available in various sizes and terminations so that they can be used in a variety of designs. Cable and connector assemblies for special applications are also available.

Microphone Grommets



These grommets are made of rubber which provide excellent insulation and eliminates interference from ambient vibrations. The surface mount holder is designed so that the "bullseye" type can be assembled easily after process completion.

PC Mounting Devices



These holders are used in the efficient assembly of PC boards. The standard types have pins that plug into the board.

Electret Condenser Microphones

Pad

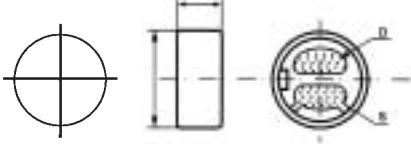

Pin

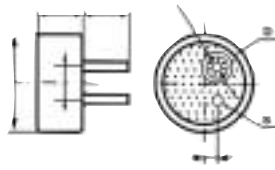

Solderless Type

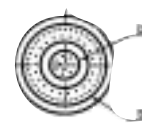

Omnidirectional

RL = 2.2K hms

Part Number	Fig	Sensitivity (0dB=V/ubar, 1KHz ± 3dB)	Frequency Range (Hz)	Operating Voltage		Current Consumption Max.	Sensitivity Reduction	S/N Ratio	Physical Size (mm)	Pin Specifications Len./Center/Pitch (mm)
				Std.	Max.					
MEO-96PD-01-603	Pad	-60	20 - 16,000	1.5V	10V	0.3mA	within -3dB @ 1V	>40dB	9.7 x 6.7	N/A
MEO-96PD-03-643 (603,563)	Pad	-64,-60,-56	20 - 16,000	3V	10V	0.8mA	within -3dB @ 3V	>40dB	9.7 x 6.7	N/A
MEO-96PD-04-663 (623,583)	Pad	-66,-62,-58	20 - 16,000	4.5V	10V	0.8mA	within -3dB @ 3V	>40dB	9.7 x 6.7	N/A
MEO-96PN-01-603	Pin	-60	20 - 16,000	1.5V	10V	0.3mA	within -3dB @ 1V	>40dB	9.7 x 6.7	7.0 2.0 2.5
MEO-96PN-03-643 (603,563)	Pin	-64,-60,-56	20 - 16,000	3V	10V	0.8mA	within -3dB @ 3V	>40dB	9.7 x 6.7	7.0 2.0 2.5
MEO-96PN-04-663 (623,583)	Pin	-66,-62,-58	20 - 16,000	4.5V	10V	0.8mA	within -3dB @ 3V	>40dB	9.7 x 6.7	7.0 2.0 2.5
MEO-94PD-01-643 (623,603)	Pad	-64,-62,-60	20 - 16,000	1.5V	10V	0.3mA	within -3dB @ 1.1V	>40dB	9.7 x 4.5	N/A
MEO-94PN-01-643 (623,603)	Pin	-64,-62,-60	20 - 16,000	1.5V	10V	0.3mA	within -3dB @ 1.1V	>40dB	9.7 x 4.5	4.5 2.0 2.5
MEO-65PD-02-663 (643,623)	Pad	-66,-64,-62	20 - 16,000	2.0V	10V	0.5mA	within -3dB @ 1.5V	>38dB	6.0 x 5.2	N/A
MEO-65PN-02-663 (643,623)	Pin	-66,-64,-62	20 - 16,000	2.0V	10V	0.5mA	within -3dB @ 1.5V	>38dB	6.0 x 5.2	7.0 0.8 2.0
MEO-63PD-02-663 (643)	Pad	-66,-64	20 - 16,000	2.0V	10V	0.5mA	within -3dB @ 1.5V	>38dB	6.0 x 3.0	N/A
MEO-63PN-02-663 (643)	Pin	-66,-64	20 - 16,000	2.0V	10V	0.5mA	within -3dB @ 1.5V	>38dB	6.0 x 3.0	2.8 0.8 2.0
MEO-627PD-02-643 (623,603,583)**	Pad	-64,-62,-60,-58	20 - 16,000	2.0V	10V	0.5mA	within -3dB @ 1.5V	>36dB	6.0 x 2.7	N/A
MEO-627PN-02-643 (623,603,583)**	Pin	-64,-62,-60,-58	20 - 16,000	2.0V	10V	0.5mA	within -3dB @ 1.5V	>36dB	6.0 x 2.7	2.8 0.8 2.0
MEO-627SM-02-643 (623,603,583)**	Sm	-64,-62,-60,-58	20 - 16,000	2.0V	10V	0.5mA	within -3dB @ 1.5V	>36dB	6.0 x 2.7	N/A
MEO-62PD-02-643 (623,603)**	Pad	-64,-62,-60	20 - 16,000	2.0V	10V	0.5mA	within -3dB @ 1.5V	>36dB	6.0 x 2.2	N/A
MEO-62PN-02-643 (623,603)**	Pin	-64,-62,-60	20 - 16,000	2.0V	10V	0.5mA	within -3dB @ 1.5V	>36dB	6.0 x 2.2	2.8 0.8 2.0
MEO-62SM-02-643 (623,603)**	Sm	-64,-62,-60	20 - 16,000	2.0V	10V	0.5mA	within -3dB @ 1.5V	>36dB	6.0 x 2.2	N/A
MEO-618PD-02-643 (623,603)**	Pad	-64,-62,-60	20 - 16,000	2.0V	10V	0.5mA	within -3dB @ 1.5V	>36dB	6.0 x 1.8	N/A
MEO-618PN-02-643 (623,603)**	Pin	-64,-62,-60	20 - 16,000	2.0V	10V	0.5mA	within -3dB @ 1.5V	>36dB	6.0 x 1.8	2.8 0.8 2.0
MEO-618SM-02-643 (623,603)**	Sm	-64,-62,-60	20 - 16,000	2.0V	10V	0.5mA	within -3dB @ 1.5V	>36dB	6.0 x 1.8	N/A
MEO-615PD-02-643 (623)**	Pad	-64,-62	20 - 16,000	2.0V	10V	0.5mA	within -3dB @ 1.5V	>36dB	6.0 x 1.5	N/A
MEO-615PN-02-643 (623)**	Pin	-64,-62	20 - 16,000	2.0V	10V	0.5mA	within -3dB @ 1.5V	>36dB	6.0 x 1.5	2.8 0.8 2.0
MEO-615SM-02-643 (623)**	Sm	-64,-62	20 - 16,000	2.0V	10V	0.5mA	within -3dB @ 1.5V	>36dB	6.0 x 1.5	N/A
MEO-427PD-02-643 (623)**	Pad	-64,-62	20 - 16,000	2.0V	10V	0.5mA	within -3dB @ 1.5V	>36dB	4.5 x 2.7	N/A
MEO-427PN-02-643 (623)**	Pin	-64,-62	20 - 16,000	2.0V	10V	0.5mA	within -3dB @ 1.5V	>36dB	4.5 x 2.7	2.8 0 1.6
MEO-422PD-02-643 (623)**	Pad	-64,-62	20 - 16,000	2.0V	10V	0.5mA	within -3dB @ 1.5V	>36dB	4.5 x 2.2	N/A
MEO-422PN-02-643 (623)**	Pin	-64,-62	20 - 16,000	2.0V	10V	0.5mA	within -3dB @ 1.5V	>36dB	4.5 x 2.2	2.8 0 1.6
MEO-418PD-02-643 (623)**	Pad	-64,-62	20 - 16,000	2.0V	10V	0.5mA	within -3dB @ 1.5V	>36dB	4.5 x 1.8	N/A
MEO-418PN-02-643 (623)**	Pin	-64,-62	20 - 16,000	2.0V	10V	0.5mA	within -3dB @ 1.5V	>36dB	4.5 x 1.8	2.8 0 1.6

Unidirectional

Sensitivity 1KHz±4dB RL = 680 ohms*

MEU-910PD-01-674	Pad	-67	100 - 12,000	1.5V	10V	0.5mA	within -3dB @ 1V	>38dB	9.7 x 8.5	N/A
MEU-910PN-01-674	Pin	-67	100 - 12,000	1.5V	10V	0.5mA	within -3dB @ 1V	>38dB	9.7 x 8.5	7.0 2.0 2.5
MEU-95PD-01-674**	Pad	-67	100 - 12,000	1.5V	10V	0.5mA	within -3dB @ 1V	>38dB	9.7 x 5.2	N/A
MEU-85PD-01-674**	Pad	-67	100 - 12,000	1.5V	10V	0.5mA	within -3dB @ 1V	>38dB	8.0 x 5.0	N/A
* MEU-65PD-02-704**	Pad	-70	100 - 12,000	2.0V	10V	0.5mA	within -3dB @ 1.5V	>35dB	6.0 x 5.2	N/A
* MEU-636PD-02-704**	Pad	-70	100 - 12,000	2.0V	10V	0.5mA	within -3dB @ 1.5V	>35dB	6.0 x 3.6	N/A
* MEU-627PD-02-704**	Pad	-70	100 - 12,000	2.0V	10V	0.5mA	within -3dB @ 1V	>35dB	6.0 x 2.7	N/A

Noise Cancelling

Sensitivity 1KHz±4dB RL = 680 ohms*

MEC-95PD-01-744**	Pad	-74	100 - 10,000	1.5V	10V	0.5mA	within -3dB @ 1V	>38dB	9.7 x 5.2	N/A
MEC-85PD-01-744**	Pad	-74	100 - 10,000	1.5V	10V	0.5mA	within -3dB @ 1V	>38dB	8.0 x 5.0	N/A
* MEC-65PD-01-744**	Pad	-74	100 - 10,000	1.5V	10V	0.5mA	within -3dB @ 1V	>38dB	6.0 x 5.2	N/A
* MEC-636PD-02-714**	Pad	-71	100 - 10,000	2.0V	10V	0.5mA	within -3dB @ 1.5V	>30dB	6.0 x 3.6	N/A
* MEC-627PD-02-714**	Pad	-71	100 - 10,000	2.0V	10V	0.5mA	within -3dB @ 1.5V	>30dB	6.0 x 2.7	N/A
* MEC-622PD-02-714**	Pad	-71	100 - 10,000	2.0V	10V	0.5mA	within -3dB @ 1.5V	>30dB	6.0 x 2.2	N/A
* MEC-618PD-02-714**	Pad	-71	100 - 10,000	2.0V	10V	0.5mA	within -3dB @ 1.5V	>30dB	6.0 x 1.8	N/A
* MEC-427PD-02-744**	Pad	-74	100 - 10,000	2.0V	10V	0.5mA	within -3dB @ 1.5V	>30dB	4.5 x 2.7	N/A
* MEC-422PD-02-744**	Pad	-74	100 - 10,000	2.0V	10V	0.5mA	within -3dB @ 1.5V	>30dB	4.5 x 2.2	N/A
* MEC-418PD-02-744**	Pad	-74	100 - 10,000	2.0V	10V	0.5mA	within -3dB @ 1.5V	>30dB	4.5 x 1.8	N/A

*RL 2.2K where noted

**Also available in Back Electret

Electret Condenser Microphones (continued)

Without Fet Impedance Converter

RL = 680 ohms

Part Number	Fig	Sensitivity (0dB=V/ubar, 1KHz±4dB)	Frequency Range	Operating Voltage		Current Consumption Max.	Sensitivity Reduction	S/N Ratio	Physical Size (mm)
				Std.	Max.				
MEO-96PD-00-564-NF(-604)	Pad	-56, -60	50 ~ 12,000Hz	N/A	N/A	N/A	N/A	N/A	9.7 x 6.7
MEO-65PD-00-564-NF	Pad	-56	50 ~ 12,000Hz	N/A	N/A	N/A	N/A	N/A	6.0 x 5.2

1. Within certain limits all of the above types can be supplied with variations in sensitivity, tolerance, and voltage.
2. Most of these types can be supplied with wire leads, connector assemblies, and waterproof construction.
3. Microphones are available with 33 pf or 10 pf capacitor or 33pf/10pf combinations upon request.

Electrical Diagrams

With FET

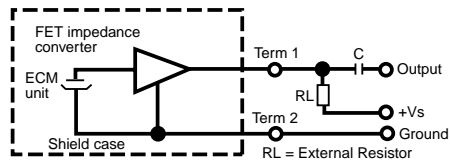

Without FET

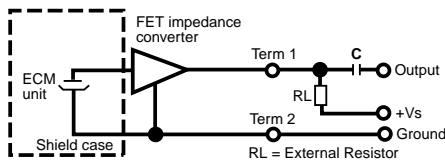

Rubber Grommet Types

Part Number	A	B	C	D	E	Microphone Size
MG-96	12 ± 0.1	7.5 ± 0.1	9.4	6	0.8	9.7 x 6.7
MG-95	12 ± 0.1	5.5 ± 0.1	9.4	6	0.5	9.7 x 4.5
MG-65	7.5 ± 0.1	5.5 ± 0.1	5.8	4	0.7	6.0 x 5.2
MG-63	7.5 ± 0.1	3.8 ± 0.1	5.8	4	0.7	6.0 x 3.6, 3.0, 2.7
MG-62	7.5 ± 0.1	3.0 ± 0.1	5.8	4	0.7	6.0 x 2.2, 1.8
MG-62SM	6.8 ± 0.1	3.8 ± 0.1	6.0	4.2	4.2	6.0 x 2.2

All dimensions in millimeters

MG-96, MG-95, MG-65, MG-63, MG-62

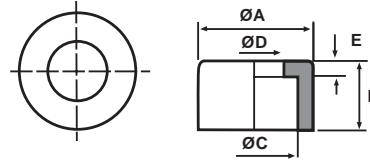

MG-62SM

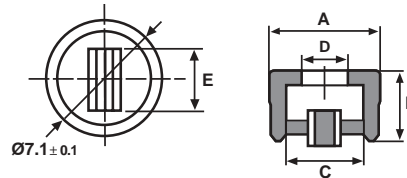

Plastic PC Mount Types

MH9-RA

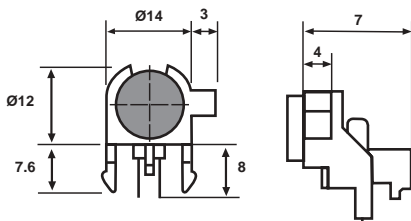

for 9.7 x 6.7, 9.7 x 4.5mm units

MH-96

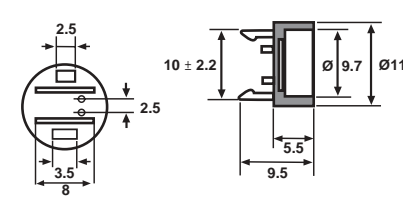

for 9.7 x 6.7mm units

ICC Intervox offers customized solutions

ICC Intervox audible devices are designed to deliver peak performance for a variety of demanding applications. In addition to offering the product as shown within this catalog, ICC Intervox can assist you with the following services:

- Cable assemblies
- Connectors
- Spring contacts for solderless connections
- SMT pick-and-place packaging
- Bar coding
- Private labeling, and more...

At ICC, we're focused on increasing the efficiency of your production with standard or customized products.



INTERVOX[®]
A Division of International Components Corp.