

PACKAGE TOP VIEW

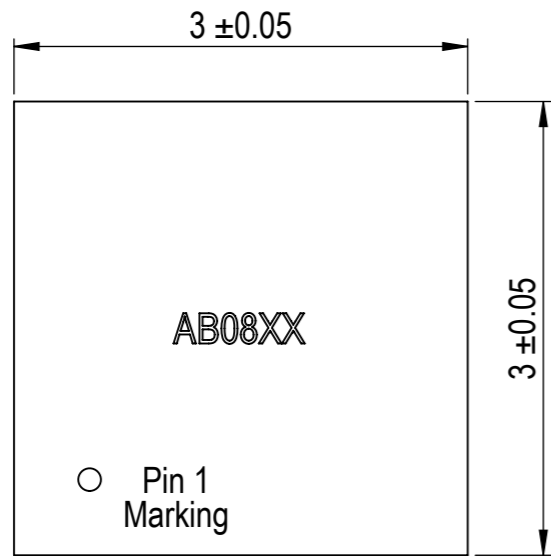

EXAMPLE PCB LAND PATTERN

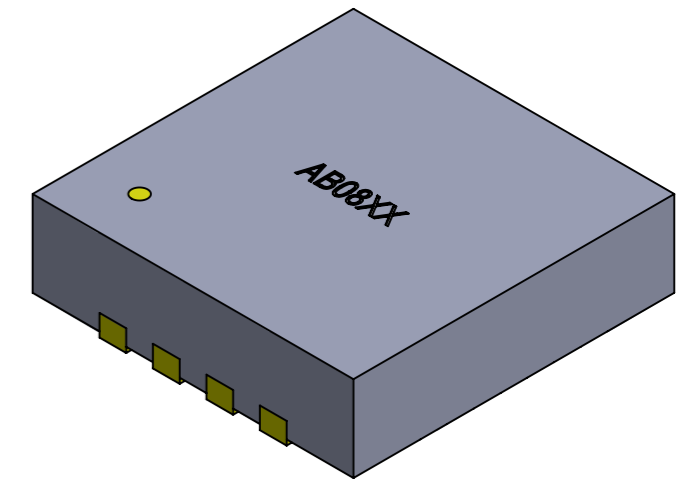
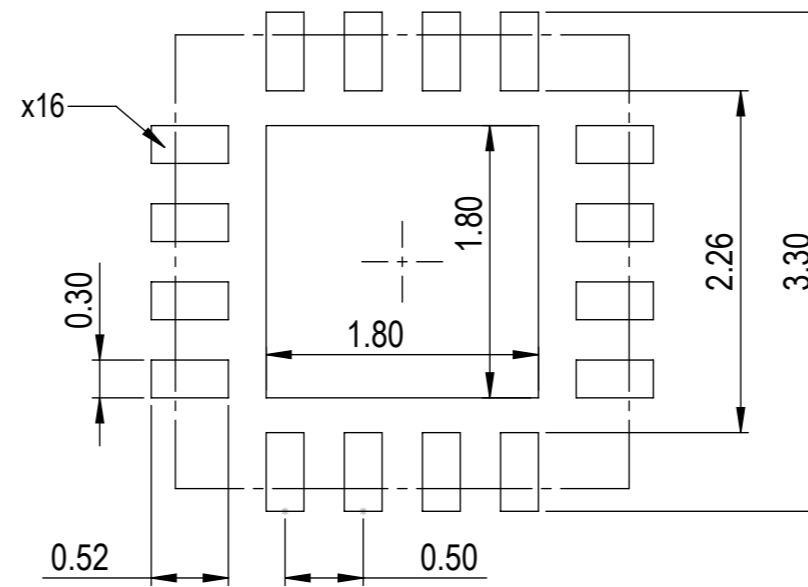

PACKAGE SIDE VIEW

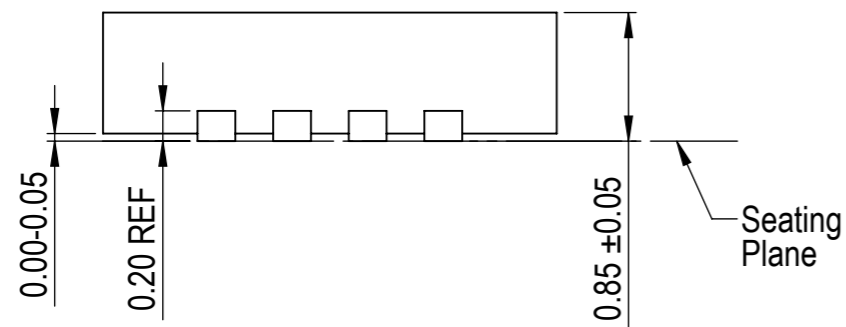

EXAMPLE SOLDER STENCIL

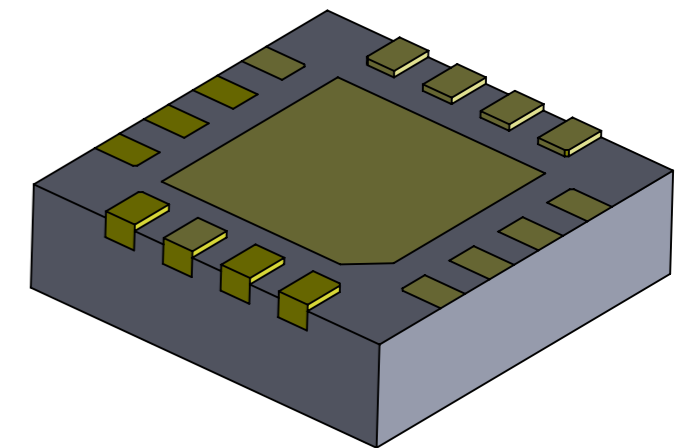
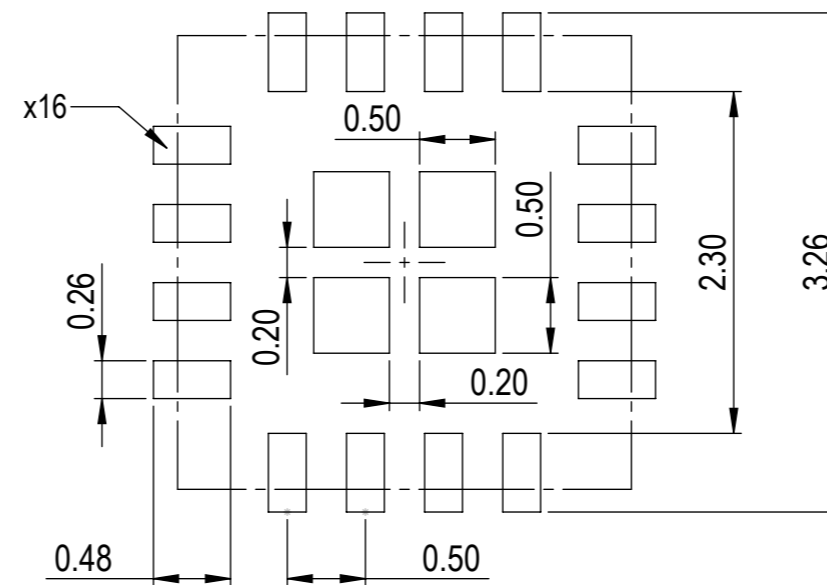

PACKAGE BOTTOM VIEW

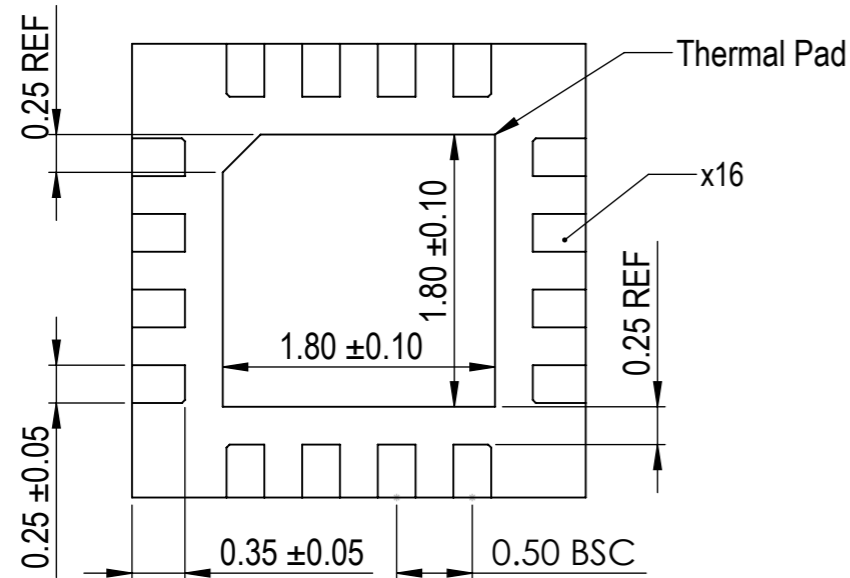

UNLESS OTHERWISE SPECIFIED: DIMENSIONS ARE IN MM SURFACE FINISH: TOLERANCES: LINEAR: ANGULAR:				FINISH:		DEBUR AND BREAK SHARP EDGES		DO NOT SCALE DRAWING		REVISION	
DRAWN				SIGNATURE		DATE		 30332 Esperanza, Rancho Santa margarita, California 92688			
CHK'D				SIGNATURE		DATE		TITLE: AB08XX Series Ultra Low Power RTC IC; User's Guide			
APPV'D				SIGNATURE		DATE		DWG NO. AB08XX			
MFG				SIGNATURE		DATE		SCALE:20:1			
Q.A				SIGNATURE		DATE		SHEET 1 OF 1			
				MATERIAL:				A3			
				WEIGHT:							