

14-Bit, 400-MSPS Analog-to-Digital Converter

 Check for Samples: [ADS5474](#)

FEATURES

- 400-MSPS Sample Rate
- 14-Bit Resolution, 11.2-Bits ENOB
- 1.4-GHz Input Bandwidth
- SFDR = 80 dBc at 230 MHz and 400 MSPS
- SNR = 69.8 dBFS at 230 MHz and 400 MSPS
- 2.2-V_{pp} Differential Input Voltage
- LVDS-Compatible Outputs
- Total Power Dissipation: 2.5 W
- Power Down Mode: 50 mW
- Offset Binary Output Format
- Output Data Transitions on the Rising and Falling Edges of a Half-Rate Output Clock
- On-Chip Analog Buffer, Track-and-Hold, and Reference Circuit
- TQFP-80 PowerPAD™ Package (14 mm × 14 mm footprint)
- Industrial Temperature Range: –40°C to +85°C
- Pin-Similar/Compatible with 12-, 13-, and 14-Bit Family: [ADS5463](#) and [ADS5440/ADS5444](#)

APPLICATIONS

- Test and Measurement Instrumentation
- Software-Defined Radio
- Data Acquisition
- Power Amplifier Linearization
- Communication Instrumentation
- Radar

DESCRIPTION

The ADS5474 is a 14-bit, 400-MSPS analog-to-digital converter (ADC) that operates from both a 5-V supply and 3.3-V supply while providing LVDS-compatible digital outputs. This ADC is one of a family of 12-, 13-, and 14-bit ADCs that operate from 210 MSPS to 500 MSPS. The ADS5474 input buffer isolates the internal switching of the onboard track and hold (T&H) from disturbing the signal source while providing a high-impedance input. An internal reference generator is also provided to simplify the system design.

Designed with a 1.4-GHz input bandwidth for the conversion of wide-bandwidth signals that exceed 400 MHz of input frequency at 400 MSPS, the ADS5474 has outstanding low-noise performance and spurious-free dynamic range over a large input frequency range.

The ADS5474 is available in an TQFP-80 PowerPAD package. The device is built on Texas Instruments complementary bipolar process (BiCom3) and is specified over the full industrial temperature range (–40°C to +85°C).

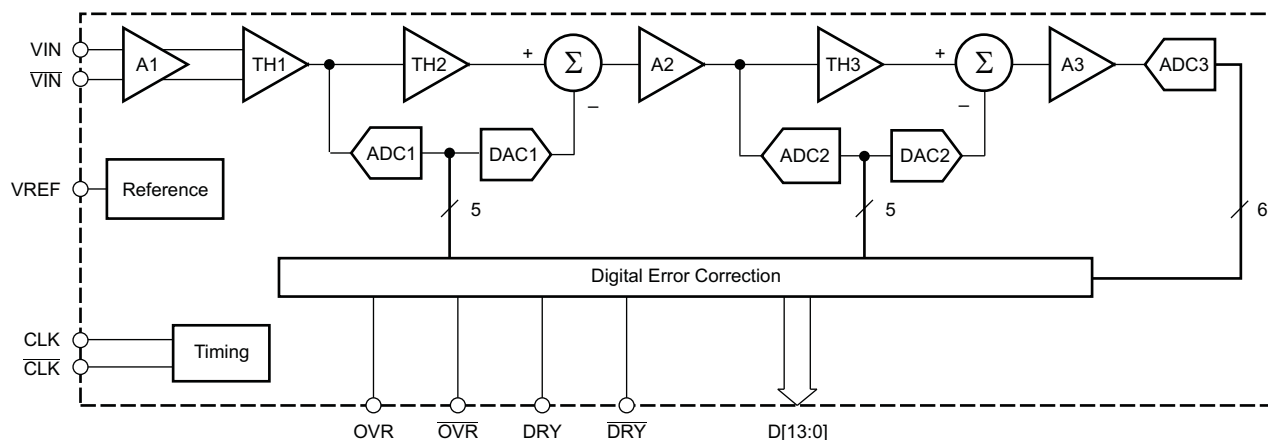

Please be aware that an important notice concerning availability, standard warranty, and use in critical applications of Texas Instruments semiconductor products and disclaimers thereto appears at the end of this data sheet.

PowerPAD is a trademark of Texas Instruments.

All other trademarks are the property of their respective owners.



This integrated circuit can be damaged by ESD. Texas Instruments recommends that all integrated circuits be handled with appropriate precautions. Failure to observe proper handling and installation procedures can cause damage.

ESD damage can range from subtle performance degradation to complete device failure. Precision integrated circuits may be more susceptible to damage because very small parametric changes could cause the device not to meet its published specifications.

Table 1. PACKAGE/ORDERING INFORMATION⁽¹⁾

PRODUCT	PACKAGE-LEAD	PACKAGE DESIGNATOR	SPECIFIED TEMPERATURE RANGE	PACKAGE MARKING	ORDERING NUMBER	TRANSPORT MEDIA, QUANTITY
ADS5474	HTQFP-80 ⁽²⁾ PowerPAD	PFP	–40°C to +85°C	ADS5474I	ADS5474IPFP	Tray, 96
					ADS5474IPFPR	Tape and Reel, 1000

(1) For the most current product and ordering information see the Package Option Addendum located at the end of this document, or see the TI web site at www.ti.com.

(2) Thermal pad size: 6.15 mm × 6.15 mm (minimum), 7.5 mm × 7.5 mm (maximum).

ABSOLUTE MAXIMUM RATINGS⁽¹⁾

Over operating free-air temperature range, unless otherwise noted.

		ADS5474	UNIT
Supply voltage	AVDD5 to GND	6	V
	AVDD3 to GND	5	V
	DVDD3 to GND	5	V
Analog input to GND	Valid when supplies are on and within normal ranges. See additional information in the Power Supplies portion of the applications information in the back of the datasheet regarding Clock and Analog Inputs when the supplies are off.	–0.3 to (AVDD5 + 0.3)	V
Clock input to GND		–0.3 to (AVDD5 + 0.3)	V
CLK to $\overline{\text{CLK}}$		±2.5	V
Digital data output to GND		–0.3 to (DVDD3 + 0.3)	V
Operating temperature range		–40 to +85	°C
Maximum junction temperature		+150	°C
Storage temperature range		–65 to +150	°C
ESD, human-body model (HBM)		2	kV

(1) Stresses above these ratings may cause permanent damage. Exposure to absolute maximum conditions for extended periods may degrade device reliability. These are stress ratings only, and functional operation of the device at these or any other conditions beyond those specified is not implied. Kirkendall voidings and current density information for calculation of expected lifetime are available upon request.

THERMAL CHARACTERISTICS⁽¹⁾

PARAMETER	TEST CONDITIONS	TYP	UNIT
R _{θJA} ⁽²⁾	Soldered thermal pad, no airflow	23.7	°C/W
	Soldered thermal pad, 150-LFM airflow	17.8	
	Soldered thermal pad, 250-LFM airflow	16.4	
R _{θJP} ⁽³⁾	Bottom of package (thermal pad)	2.99	°C/W

(1) Using 36 thermal vias (6 × 6 array). See [PowerPAD Package](#) in the [Application Information](#) section.

(2) R_{θJA} is the thermal resistance from the junction to ambient.

(3) R_{θJP} is the thermal resistance from the junction to the thermal pad.

RECOMMENDED OPERATING CONDITIONS

		ADS5474			UNIT
		MIN	NOM	MAX	
SUPPLIES					
AVDD5	Analog supply voltage	4.75	5	5.25	V
AVDD3	Analog supply voltage	3.1	3.3	3.6	V
DVDD3	Output driver supply voltage	3	3.3	3.6	V
ANALOG INPUT					
	Differential input range	2.2			V _{PP}
VCM	Input common mode	3.1			V
DIGITAL OUTPUT (DRY, DATA, OVR)					
	Maximum differential output load	10			pF
CLOCK INPUT (CLK)					
	CLK input sample rate (sine wave)	20	400		MSPS
	Clock amplitude, differential sine wave (see Figure 42)	0.5	5		V _{PP}
	Clock duty cycle (see Figure 46)	40	50	60	%
T _A	Operating free-air temperature	-40		+85	°C

ELECTRICAL CHARACTERISTICS

Typical values at T_A = +25°C: minimum and maximum values over full temperature range T_{MIN} = -40°C to T_{MAX} = +85°C, sampling rate = 400 MSPS, 50% clock duty cycle, AVDD5 = 5 V, AVDD3 = 3.3 V, DVDD3 = 3.3 V, -1 dBFS differential input, and 3-V_{PP} differential clock, unless otherwise noted.

PARAMETER		TEST CONDITIONS		ADS5474			UNIT
				MIN	TYP	MAX	
Resolution				14			Bits
ANALOG INPUTS							
	Differential input range			2.2			V _{PP}
	Analog input common-mode voltage	Self-biased; see VCM specification below		3.1			V
	Input resistance (dc)	Each input to VCM		500			Ω
	Input capacitance	Each input to GND		2.3			pF
	Analog input bandwidth (-3dB)			1.44			GHz
CMRR	Common-mode rejection ratio	Common-mode signal < 50 MHz (see Figure 27)		100			dB
INTERNAL REFERENCE VOLTAGE							
VREF	Reference voltage			2.4			V
VCM	Analog input common-mode voltage reference output	With internal VREF. Provided as an output via the VCM pin for dc-coupled applications. If an external VREF is used, the VCM pin tracks as illustrated in Figure 39		2.9	3.1	3.3	V
	VCM temperature coefficient			-0.8			mV/°C
DYNAMIC ACCURACY							
	No missing codes			Assured			
DNL	Differential linearity error	f _{IN} = 70 MHz		-0.99	±0.7	1.5	LSB
INL	Integral linearity error	f _{IN} = 70 MHz		-3	±1	3	LSB
	Offset error			-11	11		mV
	Offset temperature coefficient			0.02			mV/°C
	Gain error			-5	5		%FS
	Gain temperature coefficient			-0.02			%FS/°C

ELECTRICAL CHARACTERISTICS (continued)

Typical values at $T_A = +25^\circ\text{C}$: minimum and maximum values over full temperature range $T_{\text{MIN}} = -40^\circ\text{C}$ to $T_{\text{MAX}} = +85^\circ\text{C}$, sampling rate = 400 MSPS, 50% clock duty cycle, AVDD5 = 5 V, AVDD3 = 3.3 V, DVDD3 = 3.3 V, -1 dBFS differential input, and 3- V_{PP} differential clock, unless otherwise noted.

PARAMETER		TEST CONDITIONS	ADS5474			UNIT
			MIN	TYP	MAX	
POWER SUPPLY						
I_{AVDD5}	5-V analog supply current	$V_{\text{IN}} = \text{full-scale}, f_{\text{IN}} = 70 \text{ MHz},$ $f_{\text{S}} = 400 \text{ MSPS}$		338	372	mA
I_{AVDD3}	3.3-V analog supply current			185	201	mA
I_{DVDD3}	3.3-V digital supply current (includes LVDS)			75	83	mA
	Total power dissipation		2.5	2.797		W
	Power-up time	From turn-on of AVDD5		50		μs
	Wake-up time	From PWD pin switched from HIGH (PWD active) to LOW (ADC awake) (see Figure 28)		5		μs
	Power-down power dissipation	PWD pin = logic HIGH		50	350	mW
PSRR	Power-supply rejection ratio, AVDD5 supply			75		dB
PSRR	Power-supply rejection ratio, AVDD3 supply	Without 0.1- μF board supply capacitors, with < 1-MHz supply noise (see Figure 49)		90		dB
PSRR	Power-supply rejection ratio, DVDD3 supply			110		dB
DYNAMIC AC CHARACTERISTICS						
SNR	Signal-to-noise ratio	$f_{\text{IN}} = 30 \text{ MHz}$		70.3		dBFS
		$f_{\text{IN}} = 70 \text{ MHz}$	68.3	70.2		
		$f_{\text{IN}} = 130 \text{ MHz}$		70.1		
		$f_{\text{IN}} = 230 \text{ MHz}$	68	69.8		
		$f_{\text{IN}} = 351 \text{ MHz}$		69.1		
		$f_{\text{IN}} = 451 \text{ MHz}$		68.4		
		$f_{\text{IN}} = 651 \text{ MHz}$		67.5		
		$f_{\text{IN}} = 751 \text{ MHz}$		66.6		
SFDR	Spurious-free dynamic range	$f_{\text{IN}} = 30 \text{ MHz}$		88		dBc
		$f_{\text{IN}} = 70 \text{ MHz}$	74	86		
		$f_{\text{IN}} = 130 \text{ MHz}$		80		
		$f_{\text{IN}} = 230 \text{ MHz}$	71	80		
		$f_{\text{IN}} = 351 \text{ MHz}$		76		
		$f_{\text{IN}} = 451 \text{ MHz}$		71		
		$f_{\text{IN}} = 651 \text{ MHz}$		60		
		$f_{\text{IN}} = 751 \text{ MHz}$		55		
HD2	Second-harmonic	$f_{\text{IN}} = 30 \text{ MHz}$		89		dBc
		$f_{\text{IN}} = 70 \text{ MHz}$		87		
		$f_{\text{IN}} = 130 \text{ MHz}$		90		
		$f_{\text{IN}} = 230 \text{ MHz}$		84		
		$f_{\text{IN}} = 351 \text{ MHz}$		76		
		$f_{\text{IN}} = 451 \text{ MHz}$		71		
		$f_{\text{IN}} = 651 \text{ MHz}$		74		
		$f_{\text{IN}} = 751 \text{ MHz}$		70		
		$f_{\text{IN}} = 999 \text{ MHz}$		55		

ELECTRICAL CHARACTERISTICS (continued)

Typical values at $T_A = +25^\circ\text{C}$: minimum and maximum values over full temperature range $T_{\text{MIN}} = -40^\circ\text{C}$ to $T_{\text{MAX}} = +85^\circ\text{C}$, sampling rate = 400 MSPS, 50% clock duty cycle, AVDD5 = 5 V, AVDD3 = 3.3 V, DVDD3 = 3.3 V, -1 dBFS differential input, and $3\text{-}V_{\text{PP}}$ differential clock, unless otherwise noted.

PARAMETER	TEST CONDITIONS	ADS5474			UNIT
		MIN	TYP	MAX	
DYNAMIC AC CHARACTERISTICS (continued)					
HD3 Third-harmonic	$f_{\text{IN}} = 30 \text{ MHz}$		93		dBc
	$f_{\text{IN}} = 70 \text{ MHz}$		86		
	$f_{\text{IN}} = 130 \text{ MHz}$		80		
	$f_{\text{IN}} = 230 \text{ MHz}$		80		
	$f_{\text{IN}} = 351 \text{ MHz}$		85		
	$f_{\text{IN}} = 451 \text{ MHz}$		71		
	$f_{\text{IN}} = 651 \text{ MHz}$		60		
	$f_{\text{IN}} = 751 \text{ MHz}$		55		
	$f_{\text{IN}} = 999 \text{ MHz}$		46		
Worst harmonic/spur (other than HD2 and HD3)	$f_{\text{IN}} = 30 \text{ MHz}$		95		dBc
	$f_{\text{IN}} = 70 \text{ MHz}$		93		
	$f_{\text{IN}} = 130 \text{ MHz}$		85		
	$f_{\text{IN}} = 230 \text{ MHz}$		85		
	$f_{\text{IN}} = 351 \text{ MHz}$		87		
	$f_{\text{IN}} = 451 \text{ MHz}$		87		
	$f_{\text{IN}} = 651 \text{ MHz}$		90		
	$f_{\text{IN}} = 751 \text{ MHz}$		87		
	$f_{\text{IN}} = 999 \text{ MHz}$		80		
THD Total harmonic distortion	$f_{\text{IN}} = 30 \text{ MHz}$		86		dBc
	$f_{\text{IN}} = 70 \text{ MHz}$		83		
	$f_{\text{IN}} = 130 \text{ MHz}$		78		
	$f_{\text{IN}} = 230 \text{ MHz}$		77		
	$f_{\text{IN}} = 351 \text{ MHz}$		75		
	$f_{\text{IN}} = 451 \text{ MHz}$		68		
	$f_{\text{IN}} = 651 \text{ MHz}$		60		
	$f_{\text{IN}} = 751 \text{ MHz}$		55		
$f_{\text{IN}} = 999 \text{ MHz}$		45			

ELECTRICAL CHARACTERISTICS (continued)

Typical values at $T_A = +25^\circ\text{C}$: minimum and maximum values over full temperature range $T_{\text{MIN}} = -40^\circ\text{C}$ to $T_{\text{MAX}} = +85^\circ\text{C}$, sampling rate = 400 MSPS, 50% clock duty cycle, AVDD5 = 5 V, AVDD3 = 3.3 V, DVDD3 = 3.3 V, -1 dBFS differential input, and $3\text{-}V_{\text{PP}}$ differential clock, unless otherwise noted.

PARAMETER	TEST CONDITIONS	ADS5474			UNIT		
		MIN	TYP	MAX			
DYNAMIC AC CHARACTERISTICS (continued)							
SINAD Signal-to-noise and distortion	$f_{\text{IN}} = 30 \text{ MHz}$		69.2		dBc		
	$f_{\text{IN}} = 70 \text{ MHz}$	67	68.9				
	$f_{\text{IN}} = 130 \text{ MHz}$		68.5				
	$f_{\text{IN}} = 230 \text{ MHz}$	65.5	68.2				
	$f_{\text{IN}} = 351 \text{ MHz}$		67.3				
	$f_{\text{IN}} = 451 \text{ MHz}$		64.8				
	$f_{\text{IN}} = 651 \text{ MHz}$		58.5				
	$f_{\text{IN}} = 751 \text{ MHz}$		54				
	$f_{\text{IN}} = 999 \text{ MHz}$		45.4				
Two-tone SFDR	$f_{\text{IN1}} = 69 \text{ MHz}, f_{\text{IN2}} = 70 \text{ MHz},$ each tone at -7 dBFS		93		dBFS		
	$f_{\text{IN1}} = 69 \text{ MHz}, f_{\text{IN2}} = 70 \text{ MHz},$ each tone at -16 dBFS		95				
	$f_{\text{IN1}} = 297.5 \text{ MHz}, f_{\text{IN2}} = 302.5 \text{ MHz},$ each tone at -7 dBFS		85				
	$f_{\text{IN1}} = 297.5 \text{ MHz}, f_{\text{IN2}} = 302.5 \text{ MHz},$ each tone at -16 dBFS		83				
ENOB Effective number of bits	$f_{\text{IN}} = 70 \text{ MHz}$	10.8	11.2		Bits		
	$f_{\text{IN}} = 230 \text{ MHz}$	10.6	10.9				
RMS idle-channel noise	Inputs tied to common-mode		1.8		LSB		
DIGITAL OUTPUTS							
V_{OD}	Differential output voltage (\pm)		247	350	454	mV	
V_{OC}	Common-mode output voltage		1.125		1.375	V	
DIGITAL INPUTS							
V_{IH}	High level input voltage	PWD (pin 33)	2.0			V	
V_{IL}	Low level input voltage				0.8		V
I_{IH}	High level input current				1		μA
I_{IL}	Low level input current			-1			μA
	Input capacitance				2		pF

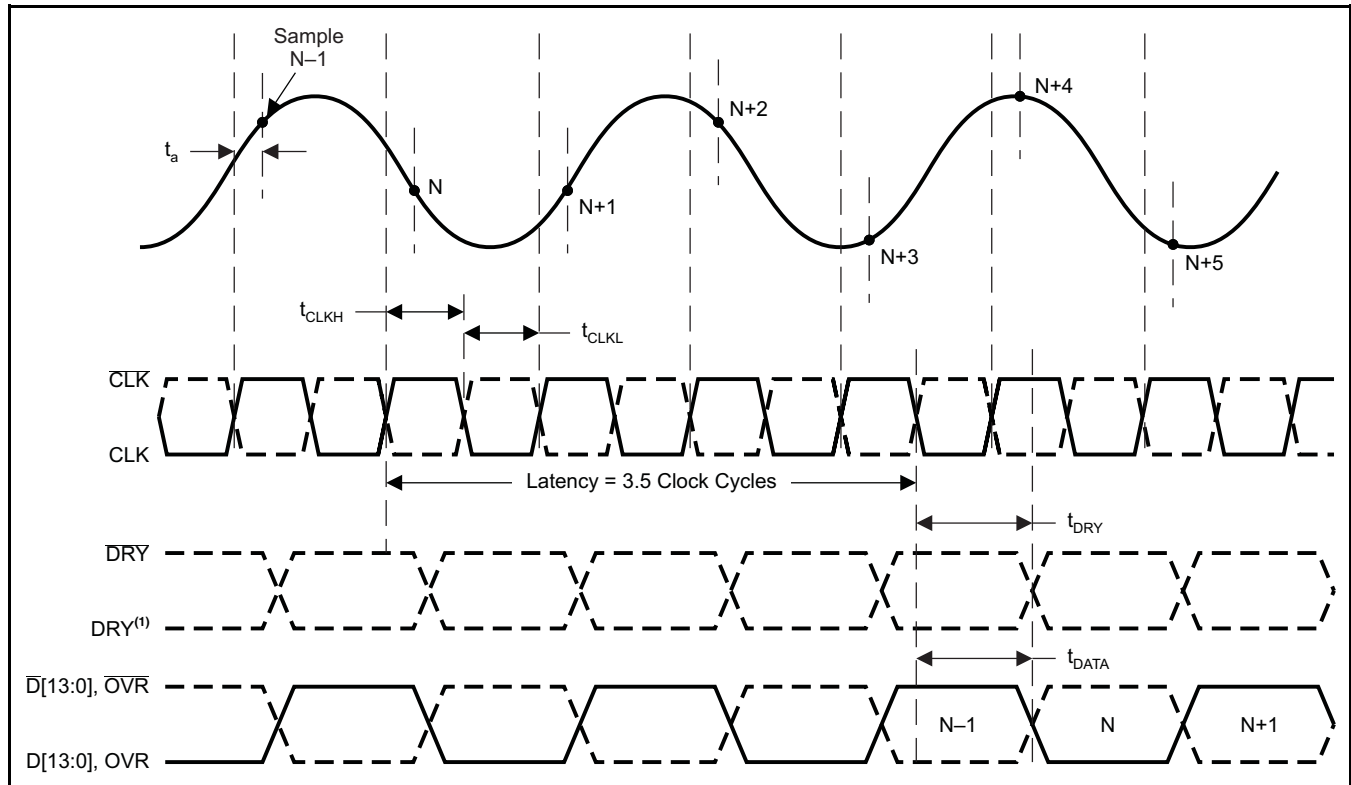
TIMING INFORMATION

(1) Polarity of DRY is undetermined. For further information, see the [Digital Outputs](#) section.

Figure 1. Timing Diagram
TIMING CHARACTERISTICS⁽¹⁾

Typical values at $T_A = +25^\circ\text{C}$: minimum and maximum values over full temperature range $T_{MIN} = -40^\circ\text{C}$ to $T_{MAX} = +85^\circ\text{C}$, sampling rate = 400 MSPS, 50% clock duty cycle, $AVDD5 = 5\text{ V}$, $AVDD3 = 3.3\text{ V}$, $DVDD3 = 3.3\text{ V}$, and $3\text{-}V_{PP}$ differential clock, unless otherwise noted.

PARAMETER	TEST CONDITIONS	MIN	TYP	MAX	UNIT
t_a Aperture delay			200		ps
Aperture jitter, rms	Internal jitter of the ADC		103		fs
Latency			3.5		cycles
t_{CLK} Clock period		2.5		50	ns
t_{CLKH} Clock pulse duration, high		1			ns
t_{CLKL} Clock pulse duration, low		1			ns
t_{DRY} CLK to DRY delay ⁽²⁾	Zero crossing, 10-pF parasitic loading to GND on each output pin	1000	1400	1800	ps
t_{DATA} CLK to DATA/OVR delay ⁽²⁾	Zero crossing, 10-pF parasitic loading to GND on each output pin	800	1400	2000	ps
t_{SKEW} DATA to DRY skew	$t_{DATA} - t_{DRY}$, 10-pF parasitic loading to GND on each output pin	-500	0	500	ps
t_{RISE} DRY/DATA/OVR rise time	10-pF parasitic loading to GND on each output pin		500		ps
t_{FALL} DRY/DATA/OVR fall time	10-pF parasitic loading to GND on each output pin		500		ps

(1) Timing parameters are assured by design or characterization, but not production tested.

(2) DRY, DATA, and OVR are updated on the falling edge of CLK. The latency must be added to t_{DATA} to determine the overall propagation delay.

PIN CONFIGURATION

PFP PACKAGE
(TOP VIEW)

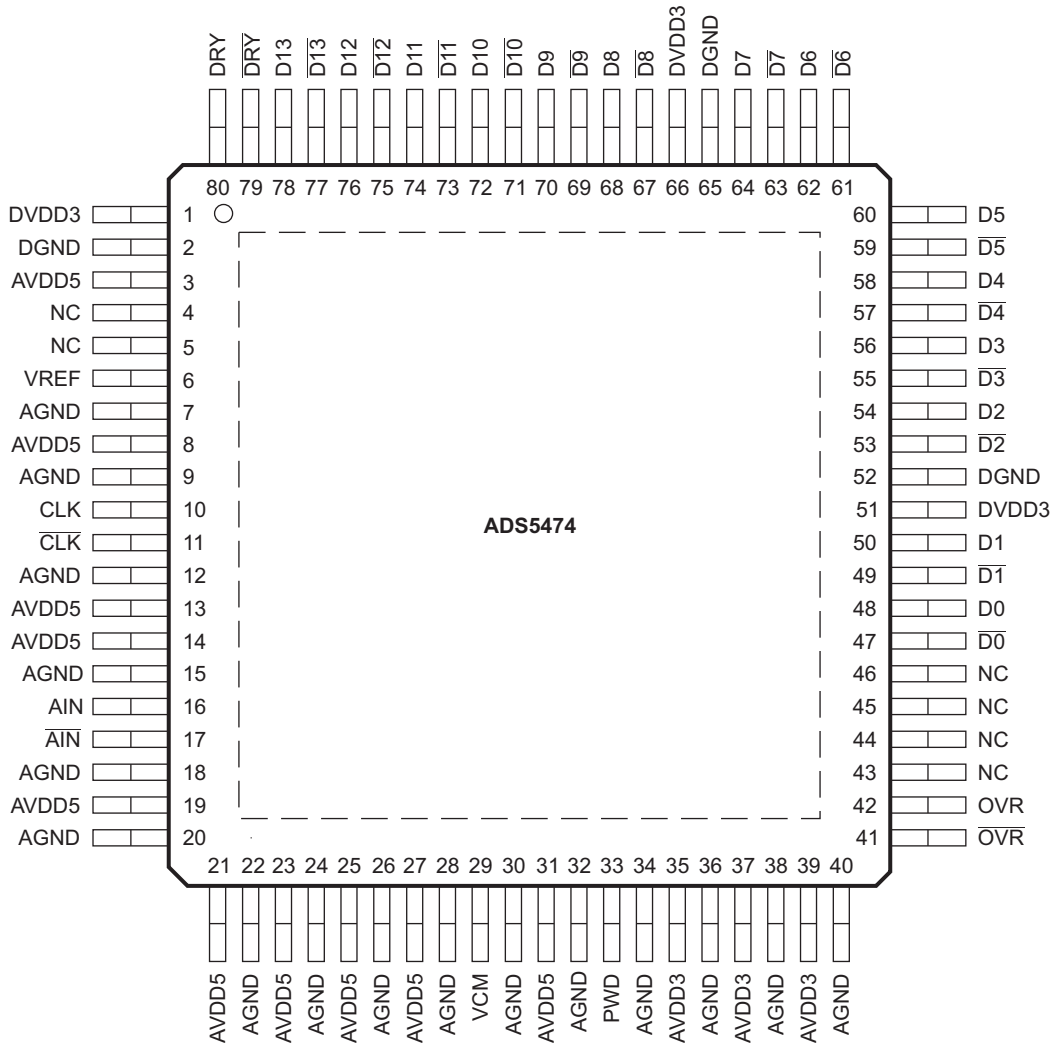

P0027-03

Table 2. TERMINAL FUNCTIONS

TERMINAL		DESCRIPTION
NAME	NO.	
AIN	16	Differential input signal (positive)
$\overline{\text{AIN}}$	17	Differential input signal (negative)
AVDD5	3, 8, 13, 14, 19, 21, 23, 25, 27, 31	Analog power supply (5 V)
AVDD3	35, 37, 39	Analog power supply (3.3 V) (Suggestion for ≤ 250 MSPS: leave option to connect to 5 V for ADS5440/ADS5444 13-bit compatibility)
DVDD3	1, 51, 66	Digital and output driver power supply (3.3 V)
AGND	7, 9, 12, 15, 18, 20, 22, 24, 26, 28, 30, 32, 34, 36, 38, 40	Analog Ground
(Power Pad)	(not numbered)	Power Pad for thermal relief, also Analog Ground
DGND	2, 52, 65	Digital Ground
CLK	10	Differential input clock (positive). Conversion is initiated on rising edge, digital outputs on falling edge.
$\overline{\text{CLK}}$	11	Differential input clock (negative)
D0, $\overline{\text{D0}}$	48, 47	LVDS digital output pair, least significant bit (LSB)
D1–D12, $\overline{\text{D1}}\text{--}\overline{\text{D12}}$	49, 50, 53–64, 67–76	LVDS digital output pairs
D13, $\overline{\text{D13}}$	78, 77	LVDS digital output pair, most significant bit (MSB)
DRY, $\overline{\text{DRY}}$	80, 79	Data ready LVDS output pair
NC	4, 5, 43–46	No connect (pins 4 and 5 should be left floating; pins 43 to 46 are possible future bit additions for this pinout and therefore can be connected to a digital bus or left floating)
OVR, $\overline{\text{OVR}}$	42, 41	Overrange indicator LVDS output. A logic high signals an analog input in excess of the full-scale range.
VCM	29	Common-mode voltage output (3.1 V nominal). Commonly used in DC-coupled applications to set the input signal to the correct common-mode voltage. A 0.1 μ F capacitor from VCM to AGND is recommended, but not required. (This pin is not used on the ADS5440 , ADS5444 , and ADS5463)
PWD	33	Power-down (active high). Device is in sleep mode when PWD pin is logic HIGH. ADC converter is awake when PWD is logic LOW (grounded). (This pin is not used on the ADS5440 , ADS5444 , and ADS5463)
VREF	6	Reference voltage input/output (2.4 V nominal). A 0.1 μ F capacitor from VREF to AGND is recommended, but not required.

TYPICAL CHARACTERISTICS

At $T_A = +25^\circ\text{C}$, sampling rate = 400 MSPS, 50% clock duty cycle, $3-V_{PP}$ differential sinusoidal clock, analog input amplitude = -1 dBFS , $AV_{DD5} = 5\text{ V}$, $AV_{DD3} = 3.3\text{ V}$, and $DV_{DD3} = 3.3\text{ V}$, unless otherwise noted.

**SPECTRAL PERFORMANCE
FFT FOR 30 MHz INPUT SIGNAL**

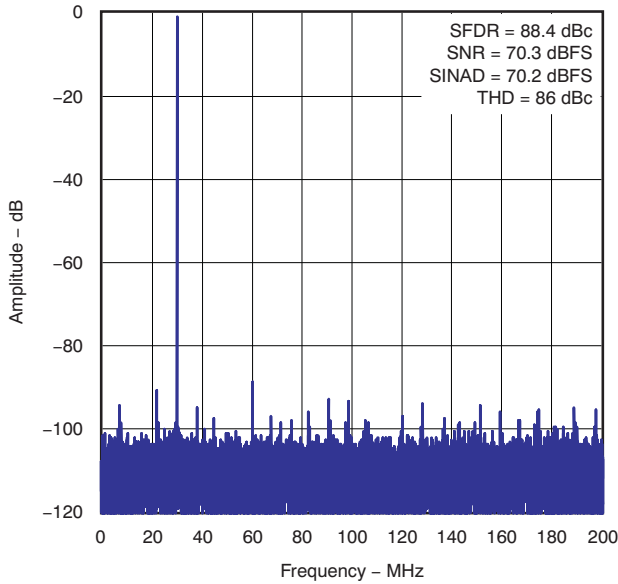

Figure 2.

**SPECTRAL PERFORMANCE
FFT FOR 70 MHz INPUT SIGNAL**

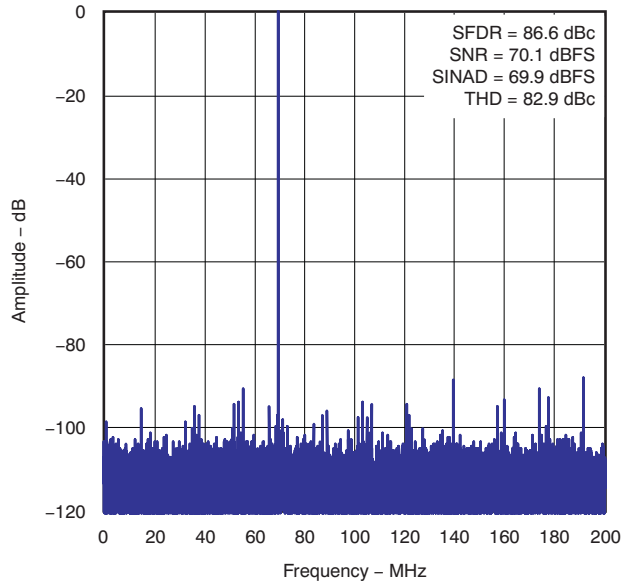

Figure 3.

**SPECTRAL PERFORMANCE
FFT FOR 130 MHz INPUT SIGNAL**

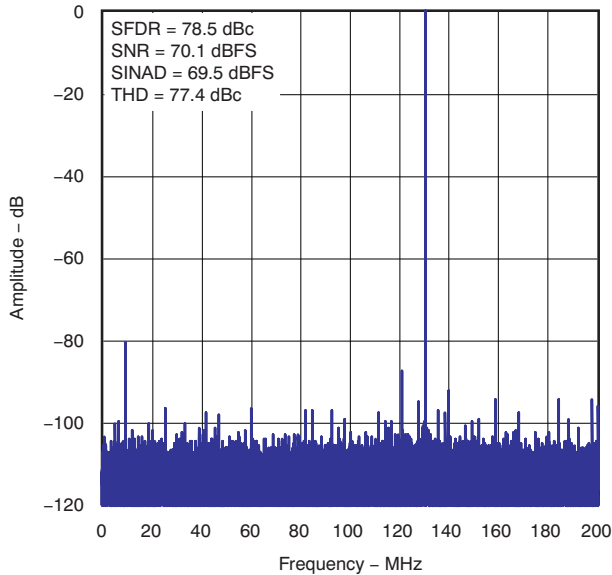

Figure 4.

**SPECTRAL PERFORMANCE
FFT FOR 230 MHz INPUT SIGNAL**

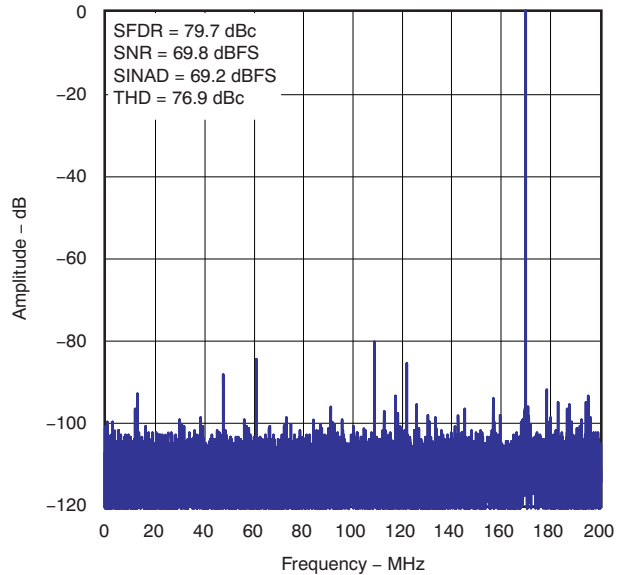

Figure 5.

TYPICAL CHARACTERISTICS (continued)

At $T_A = +25^\circ\text{C}$, sampling rate = 400 MSPS, 50% clock duty cycle, 3- V_{PP} differential sinusoidal clock, analog input amplitude = -1 dBFS, AVDD5 = 5 V, AVDD3 = 3.3 V, and DVDD3 = 3.3 V, unless otherwise noted.

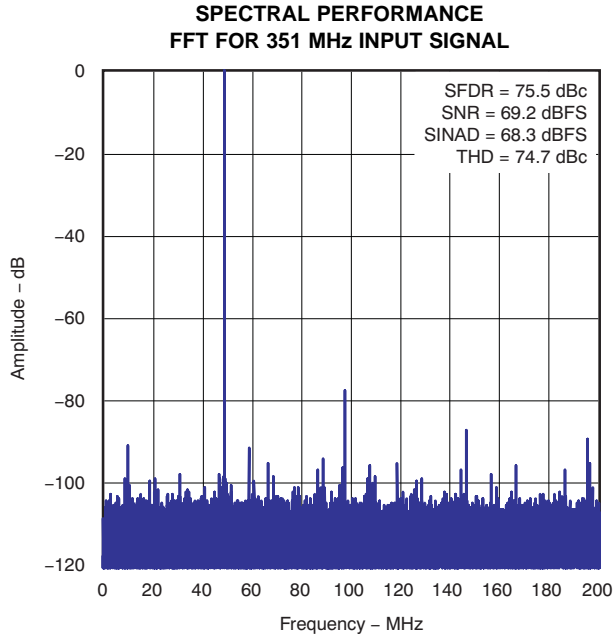

Figure 6.

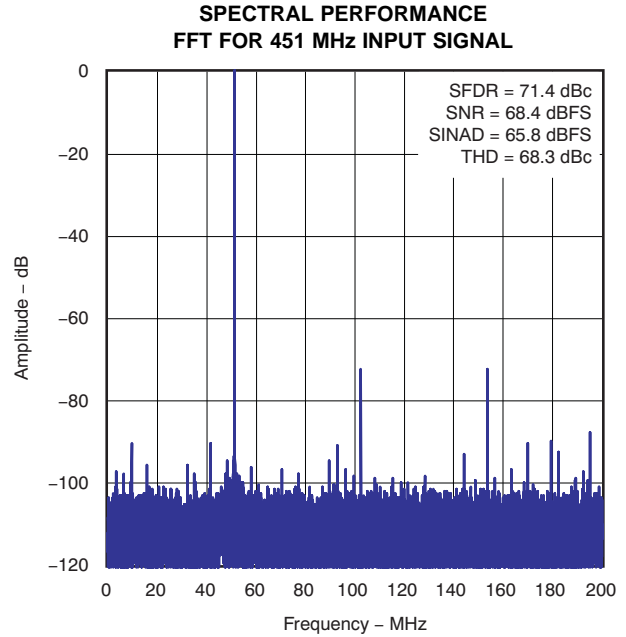

Figure 7.

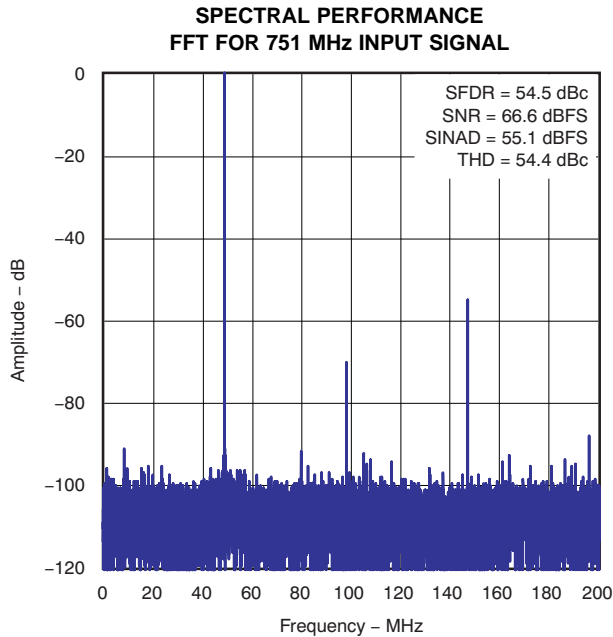

Figure 8.

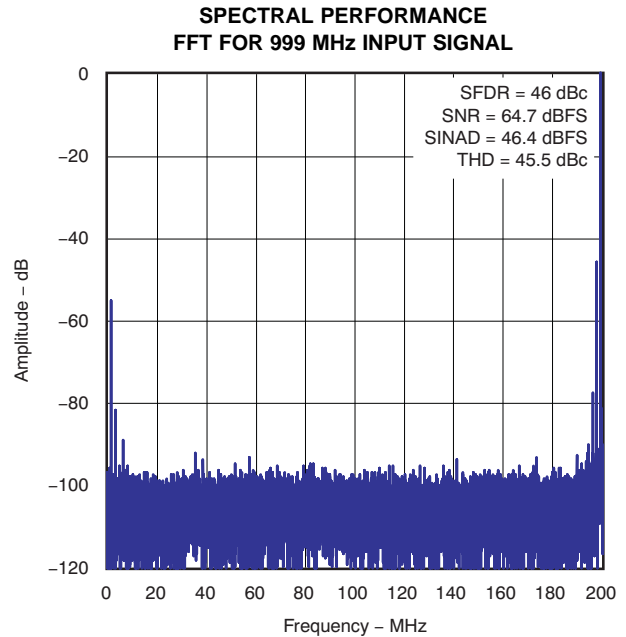

Figure 9.

TYPICAL CHARACTERISTICS (continued)

At $T_A = +25^\circ\text{C}$, sampling rate = 400 MSPS, 50% clock duty cycle, 3- V_{PP} differential sinusoidal clock, analog input amplitude = -1 dBFS, AVDD5 = 5 V, AVDD3 = 3.3 V, and DVDD3 = 3.3 V, unless otherwise noted.

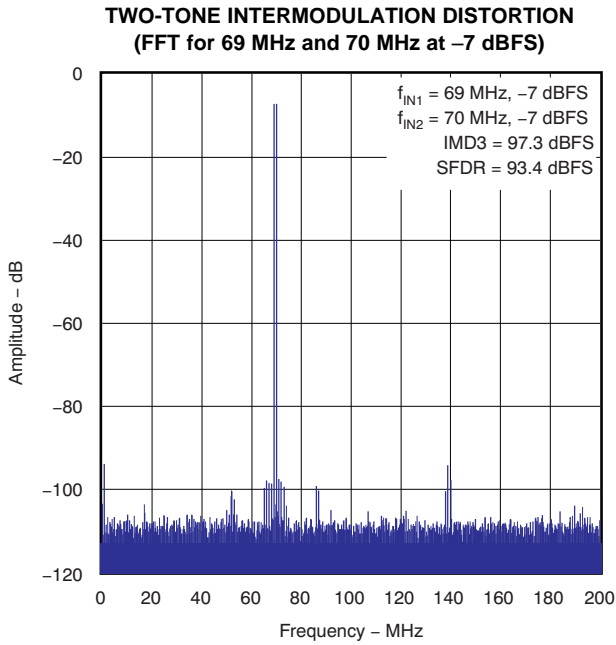

Figure 10.

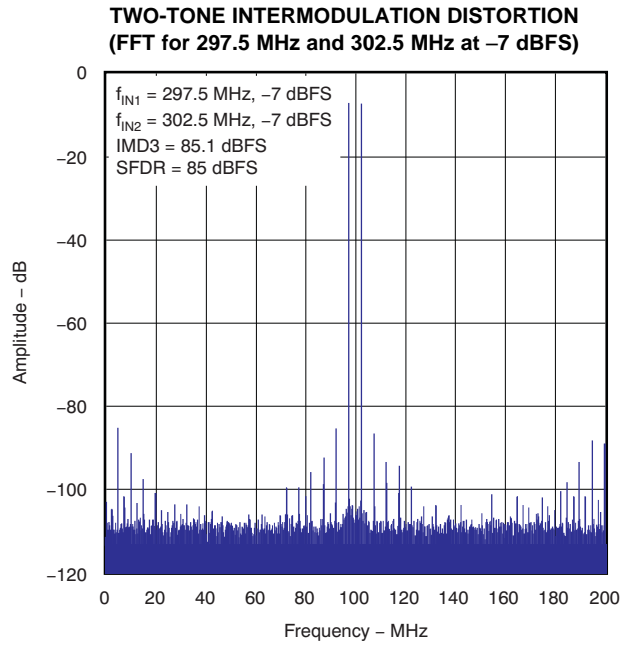

Figure 11.

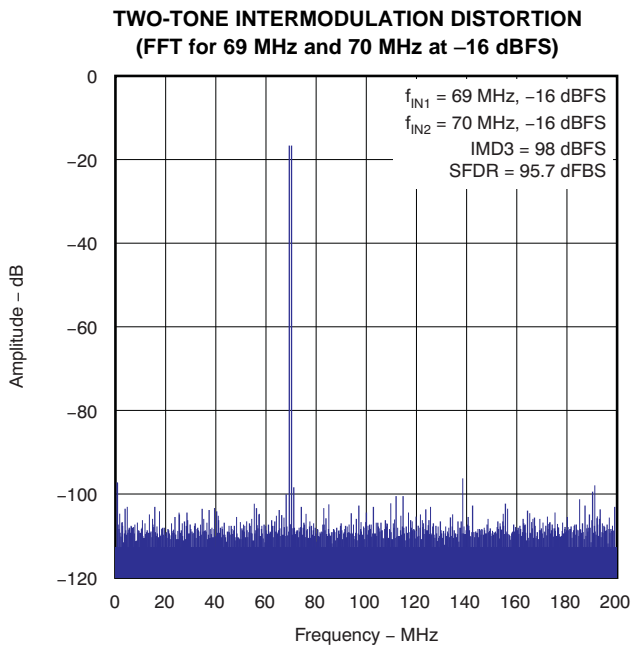

Figure 12.

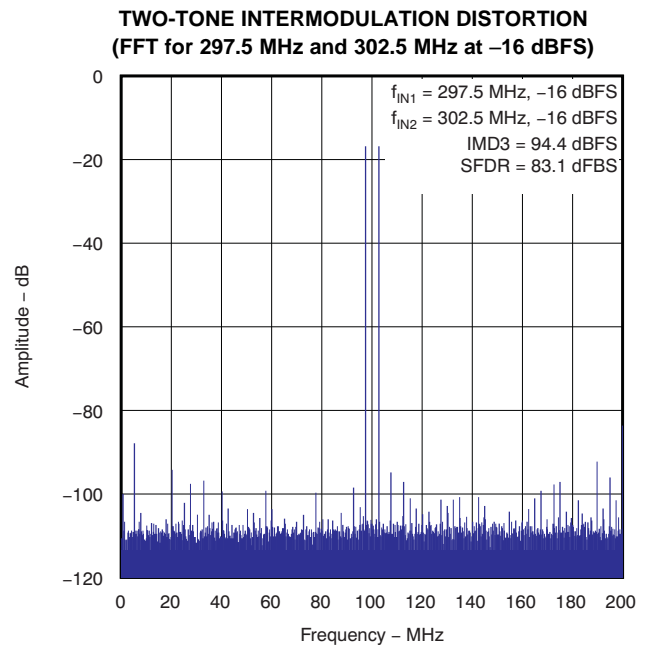

Figure 13.

TYPICAL CHARACTERISTICS (continued)

At $T_A = +25^\circ\text{C}$, sampling rate = 400 MSPS, 50% clock duty cycle, $3\text{-}V_{PP}$ differential sinusoidal clock, analog input amplitude = -1 dBFS , $AV_{DD5} = 5\text{ V}$, $AV_{DD3} = 3.3\text{ V}$, and $DV_{DD3} = 3.3\text{ V}$, unless otherwise noted.

NORMALIZED GAIN RESPONSE

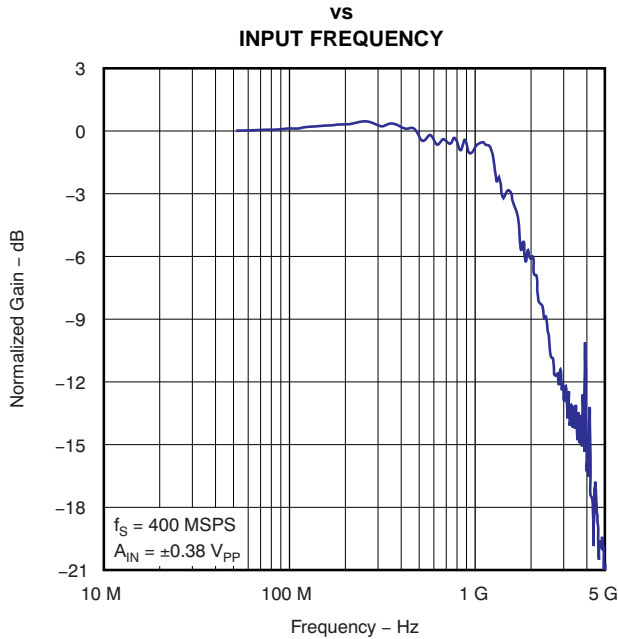

Figure 14.

DIFFERENTIAL NONLINEARITY

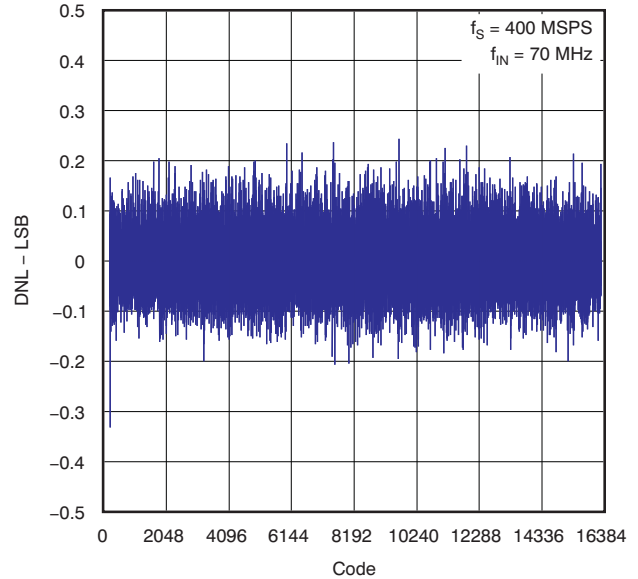

Figure 15.

INTEGRAL NONLINEARITY

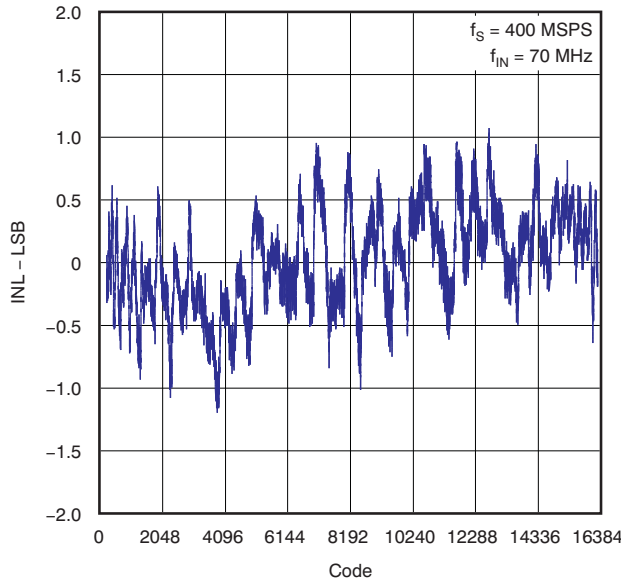

Figure 16.

NOISE HISTOGRAM WITH INPUTS SHORTED

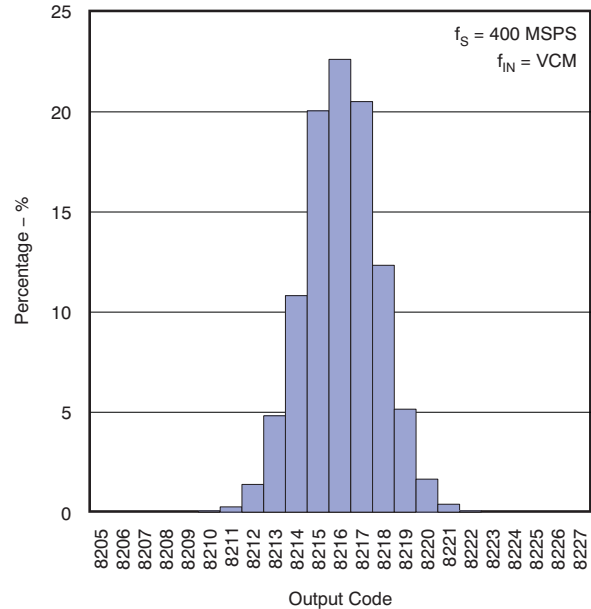

Figure 17.

TYPICAL CHARACTERISTICS (continued)

At $T_A = +25^\circ\text{C}$, sampling rate = 400 MSPS, 50% clock duty cycle, 3- V_{PP} differential sinusoidal clock, analog input amplitude = -1 dBFS, AVDD5 = 5 V, AVDD3 = 3.3 V, and DVDD3 = 3.3 V, unless otherwise noted.

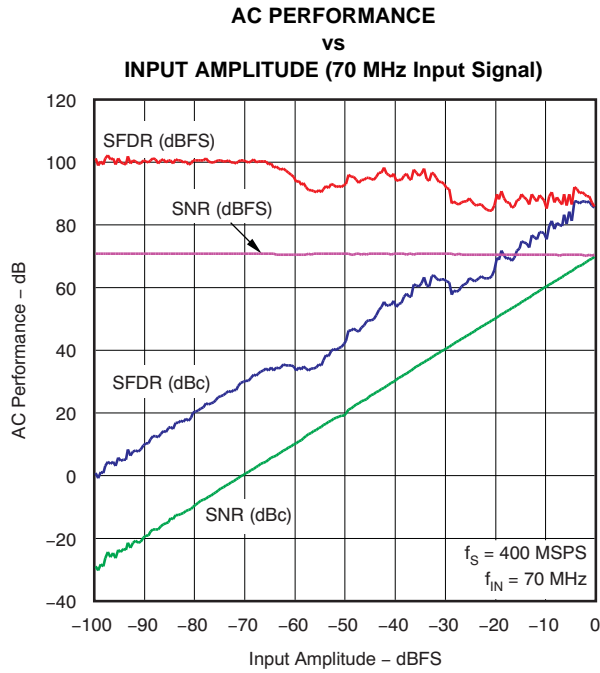

Figure 18.

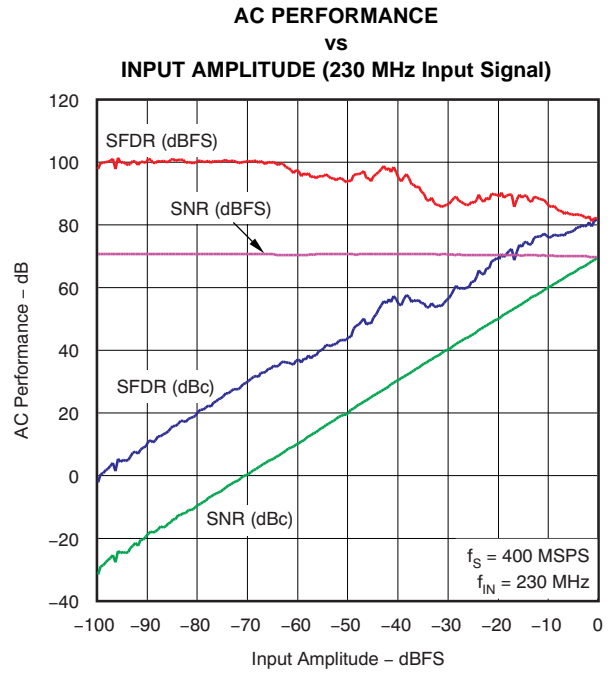

Figure 19.

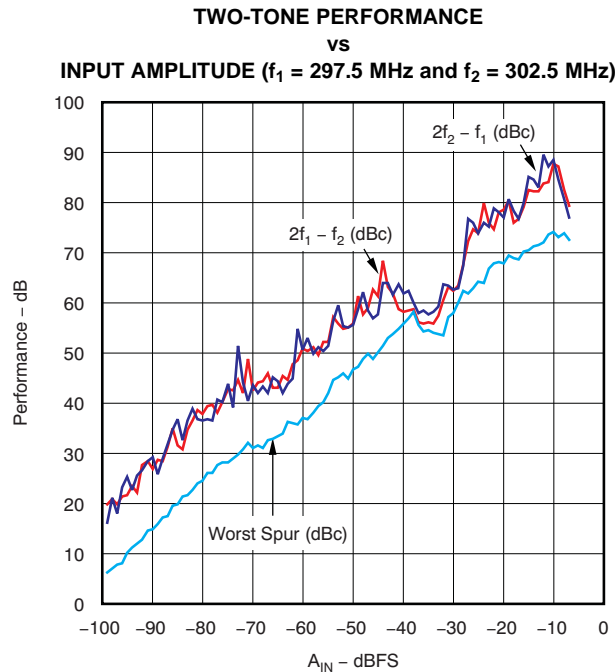

Figure 20.

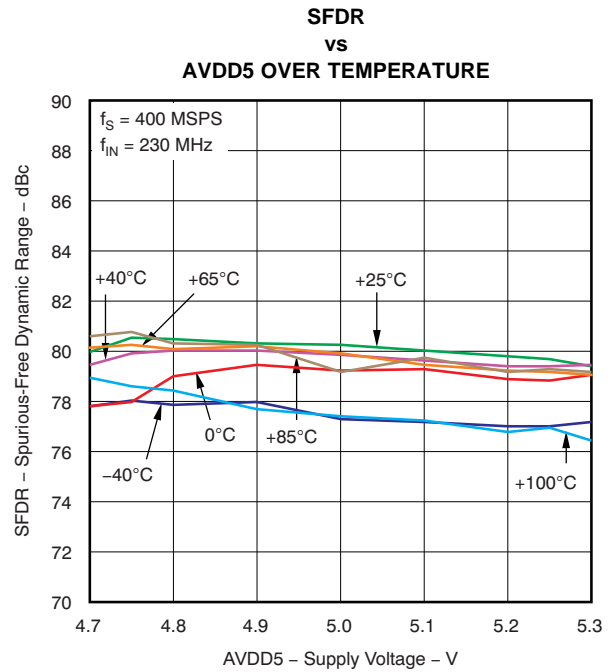

Figure 21.

TYPICAL CHARACTERISTICS (continued)

At $T_A = +25^\circ\text{C}$, sampling rate = 400 MSPS, 50% clock duty cycle, 3- V_{PP} differential sinusoidal clock, analog input amplitude = -1 dBFS, AVDD5 = 5 V, AVDD3 = 3.3 V, and DVDD3 = 3.3 V, unless otherwise noted.

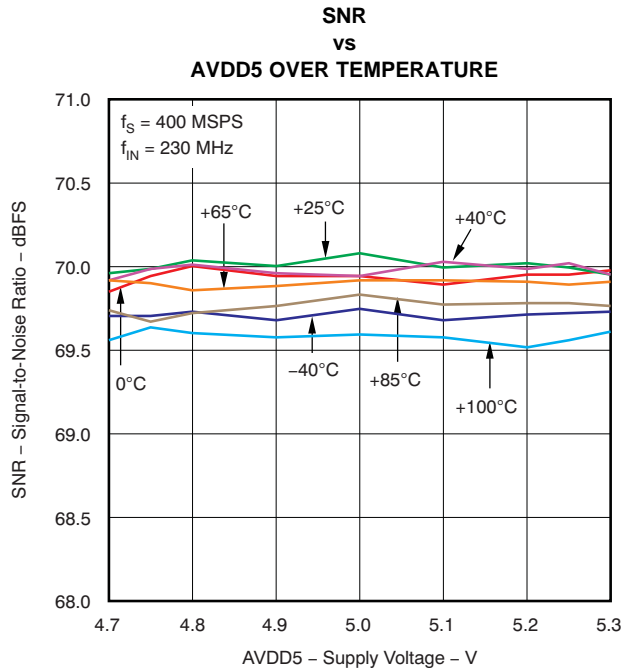

Figure 22.

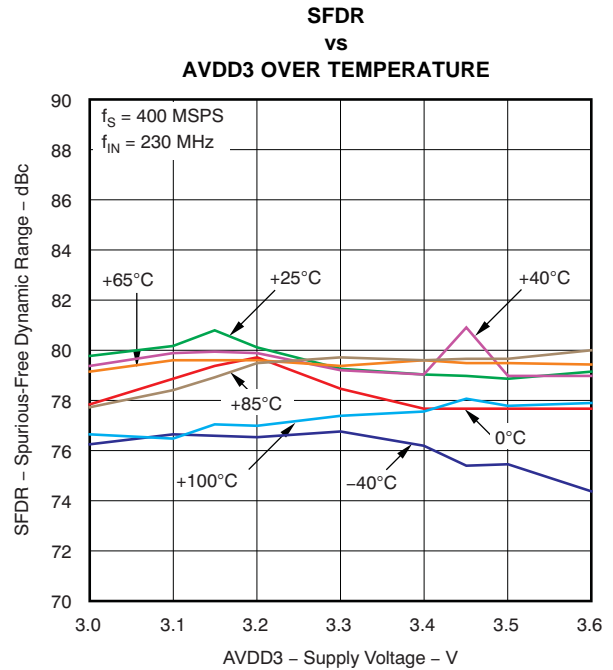

Figure 23.

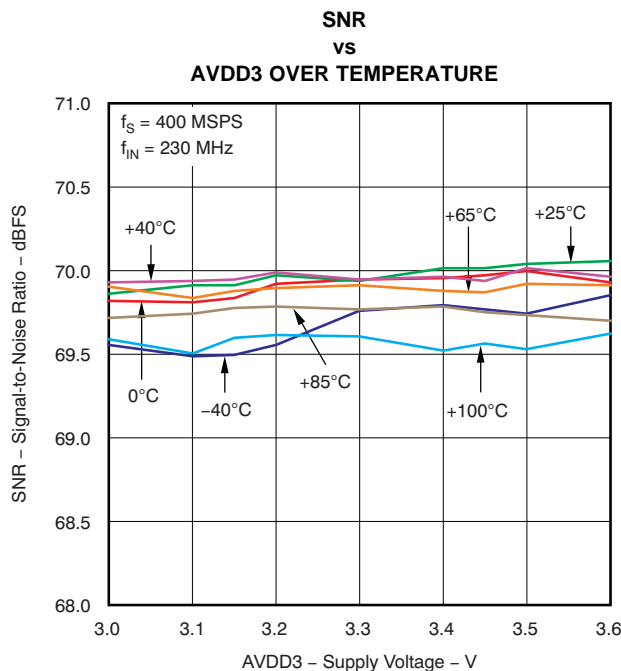

Figure 24.

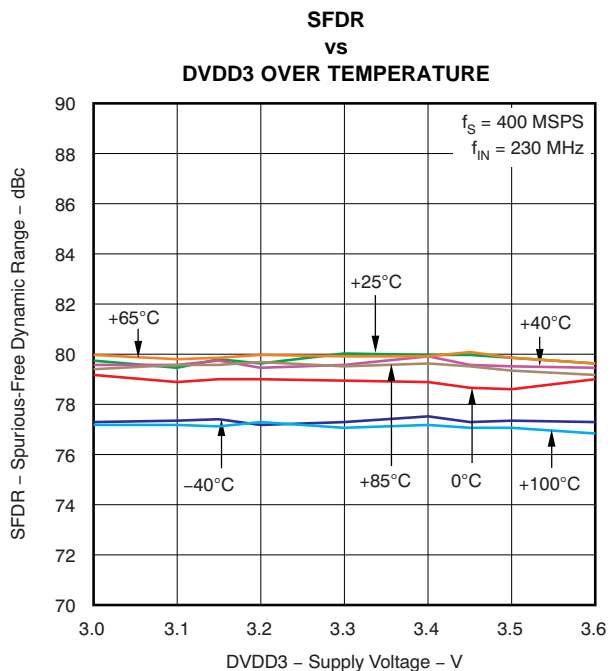

Figure 25.

TYPICAL CHARACTERISTICS (continued)

At $T_A = +25^\circ\text{C}$, sampling rate = 400 MSPS, 50% clock duty cycle, 3-V_{PP} differential sinusoidal clock, analog input amplitude = -1 dBFS , $AVDD5 = 5\text{ V}$, $AVDD3 = 3.3\text{ V}$, and $DVDD3 = 3.3\text{ V}$, unless otherwise noted.

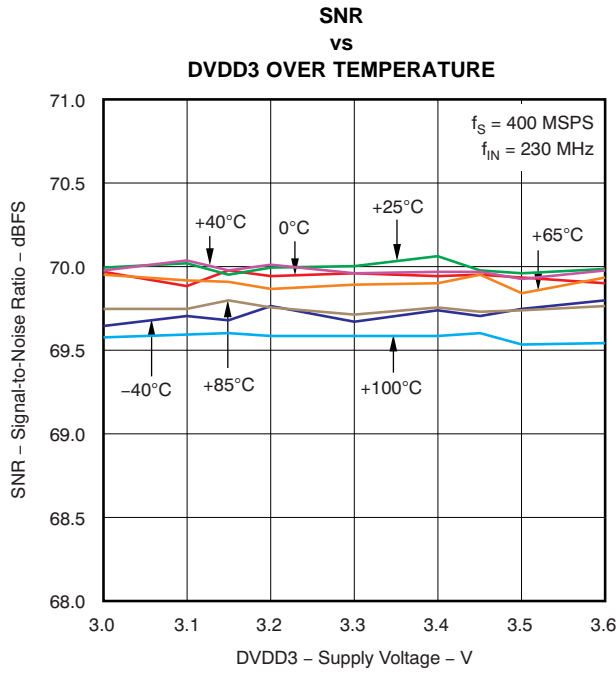

Figure 26.

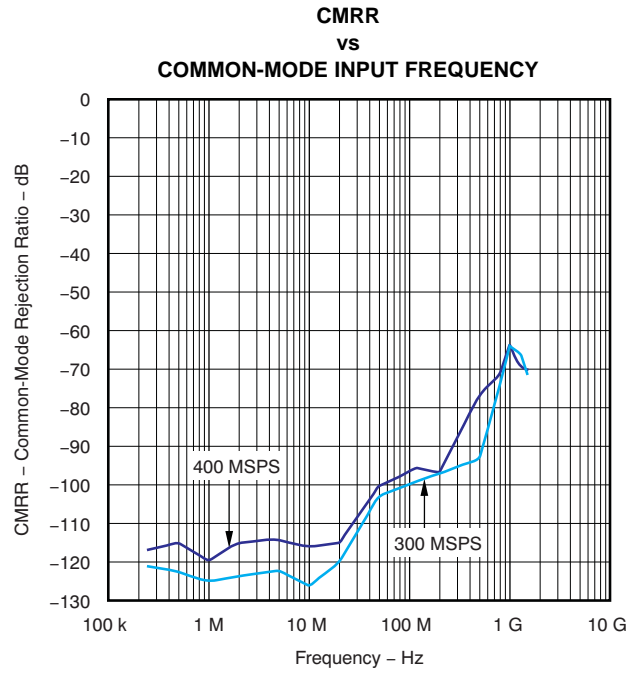

Figure 27.

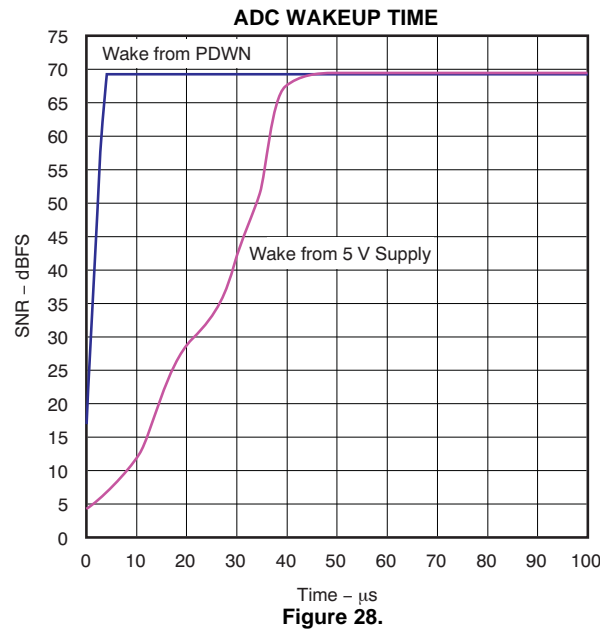

Figure 28.

TYPICAL CHARACTERISTICS (continued)

At $T_A = +25^\circ\text{C}$, sampling rate = 400 MSPS, 50% clock duty cycle, 3- V_{PP} differential sinusoidal clock, analog input amplitude = -1 dBFS, AVDD5 = 5 V, AVDD3 = 3.3 V, and DVDD3 = 3.3 V, unless otherwise noted.

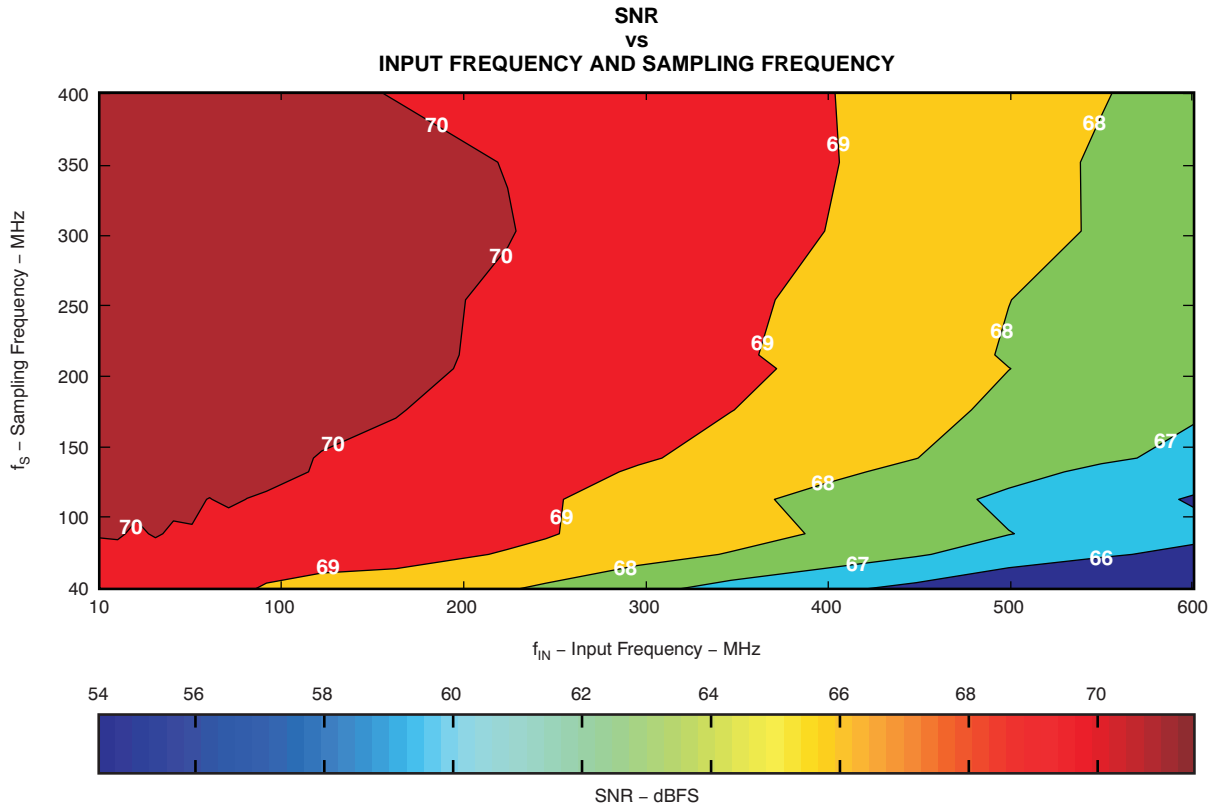
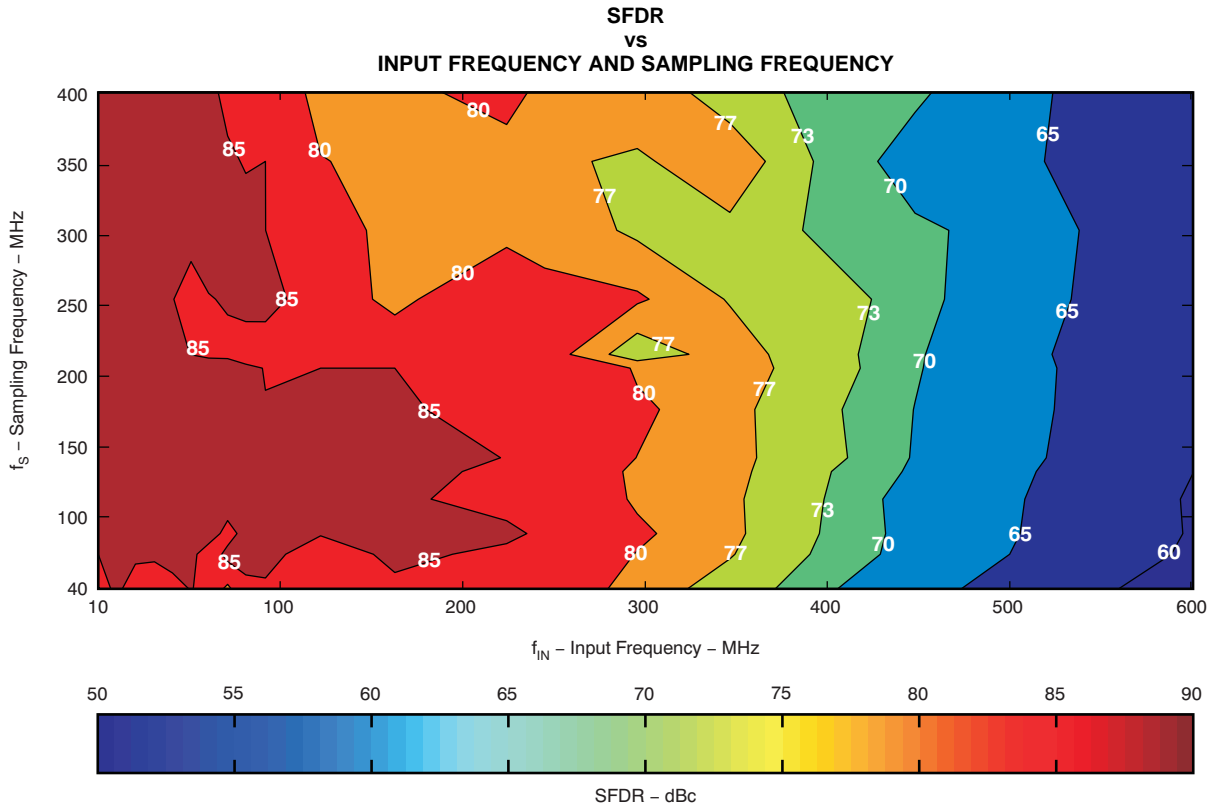

Figure 29.

TYPICAL CHARACTERISTICS (continued)

At $T_A = +25^\circ\text{C}$, sampling rate = 400 MSPS, 50% clock duty cycle, 3- V_{PP} differential sinusoidal clock, analog input amplitude = -1 dBFS, AVDD5 = 5 V, AVDD3 = 3.3 V, and DVDD3 = 3.3 V, unless otherwise noted.



APPLICATIONS INFORMATION

Theory of Operation

The ADS5474 is a 14-bit, 400-MSPS, monolithic pipeline ADC. Its bipolar analog core operates from 5-V and 3.3-V supplies, while the output uses a 3.3-V supply to provide LVDS-compatible outputs. The conversion process is initiated by the rising edge of the external input clock. At that instant, the differential input signal is captured by the input track-and-hold (T&H), and the input sample is converted sequentially by a series of lower resolution stages, with the outputs combined in a digital correction logic block. Both the rising and the falling clock edges are used to propagate the sample through the pipeline every half clock cycle. This process results in a data latency of 3.5 clock cycles, after which the output data are available as a 14-bit parallel word, coded in offset binary format.

Input Configuration

The analog input for the ADS5474 consists of an analog pseudo-differential buffer followed by a bipolar transistor T&H. The analog buffer isolates the source driving the input of the ADC from any internal switching and presents a high impedance that is easy to drive at high input frequencies, compared to an ADC without a buffered input. The input common-mode is set internally through a 500- Ω resistor connected from 3.1 V to each of the inputs (common-mode is $\sim 2.4\text{V}$ on 12- and 13-bit members of this family). This configuration results in a differential input impedance of 1 k Ω .

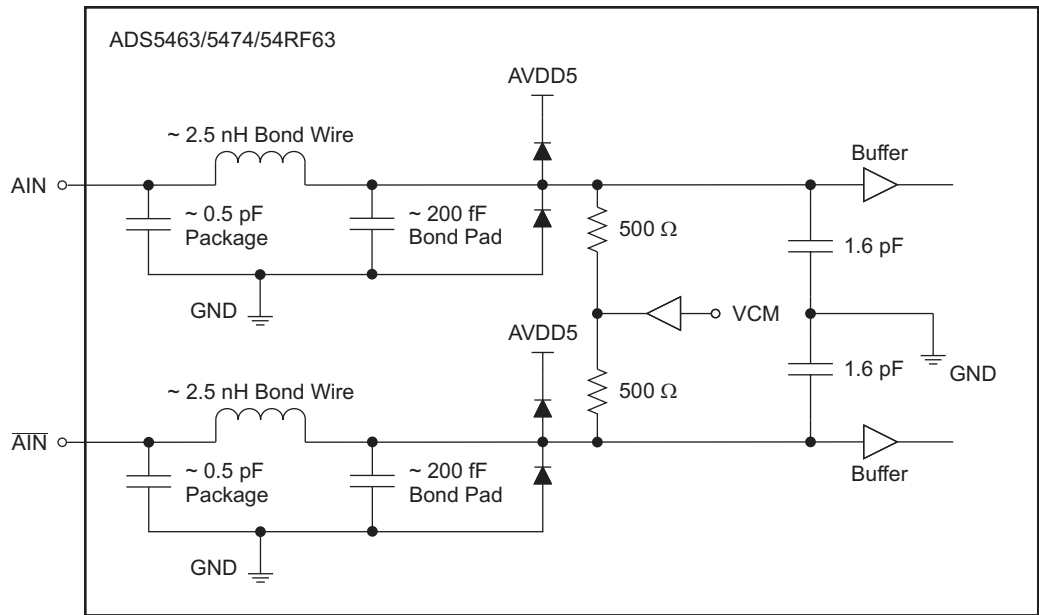

S0293-01

Figure 31. Analog Input Equivalent Circuit

For a full-scale differential input, each of the differential lines of the input signal (pins 16 and 17) swings symmetrically between $(3.1\text{ V} + 0.55\text{ V})$ and $(3.1\text{ V} - 0.55\text{ V})$. This range means that each input has a maximum signal swing of 1.1 V_{PP} for a total differential input signal swing of 2.2 V_{PP} . Operation below 2.2 V_{PP} is allowable, with the characteristics of performance versus input amplitude demonstrated in [Figure 18](#) and [Figure 19](#). For instance, for performance at 1.1 V_{PP} rather than 2.2 V_{PP} , refer to the SNR and SFDR at -6 dBFS ($0\text{ dBFS} = 2.2\text{ V}_{PP}$). The maximum swing is determined by the internal reference voltage generator, eliminating the need for any external circuitry for this purpose.

The ADS5474 performs optimally when the analog inputs are driven differentially. The circuit in Figure 32 shows one possible configuration using an RF transformer with termination either on the primary or on the secondary of the transformer. In addition, the evaluation module is configured with two back-to-back transformers, also demonstrating good performance. If voltage gain is required, a step-up transformer can be used.

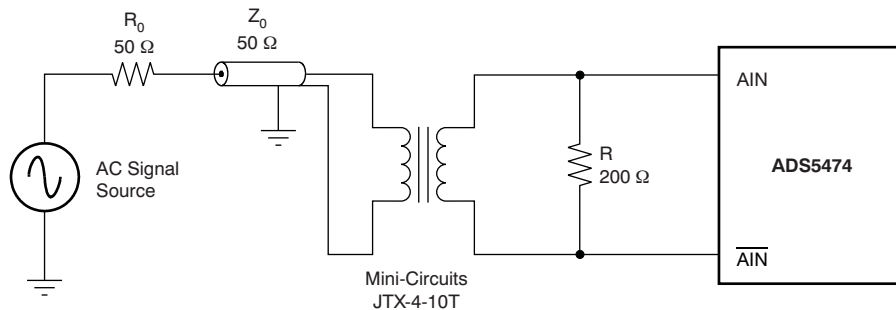

Figure 32. Converting a Single-Ended Input to a Differential Signal Using an RF Transformer

In addition to the transformer configurations, Texas Instruments offers a wide selection of single-ended operational amplifiers that can be selected depending on the application. An RF gain-block amplifier, such as Texas Instruments' THS9001, can also be used for high-input-frequency applications. For large voltage gains at intermediate-frequencies in the 50 MHz to 400 MHz range, the configuration shown in Figure 33 can be used. The component values can be tuned for different intermediate frequencies. The example shown in Figure 33 is located on the evaluation module and is tuned for an IF of 170 MHz. More information regarding this configuration can be found in the ADS5474 EVM User Guide (SLAU194) and the THS9001 50-MHz to 350-MHz Cascadeable Amplifier data sheet (SLOS426), both available for download at www.ti.com.

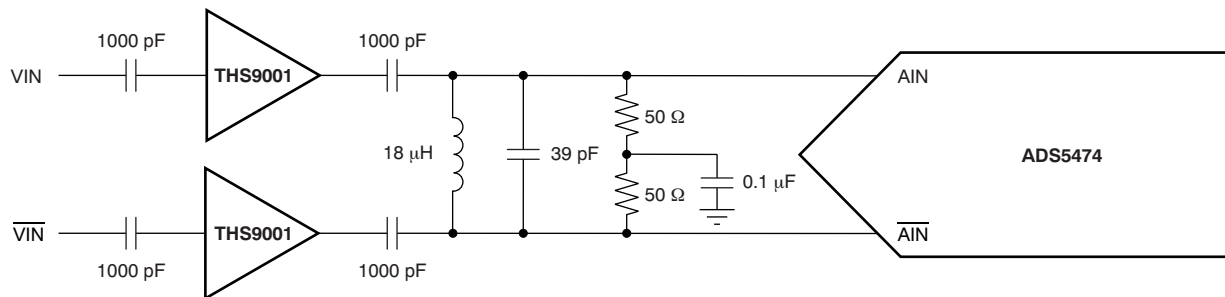

Figure 33. Using the THS9001 IF Amplifier With the ADS5474

For applications requiring dc-coupling with the signal source, a differential input/differential output amplifier such as the [THS4509](#) (shown in [Figure 34](#)) provides good harmonic performance and low noise over a wide range of frequencies.

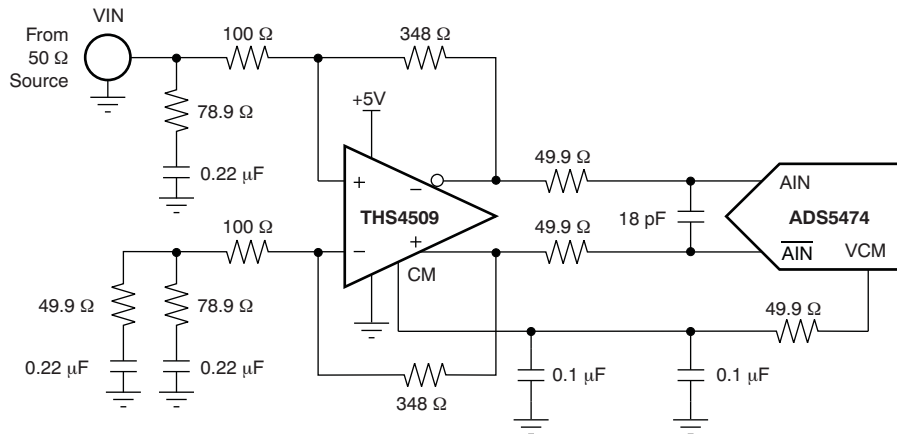

Figure 34. Using the THS4509 or THS4520 With the ADS5474

In this configuration, the THS4509 amplifier circuit provides 10 dB of gain, converts the single-ended input to differential, and sets the proper input common-mode voltage to the ADS5474 by utilizing the VCM output pin of the ADC. The 50- Ω resistors and 18-pF capacitor between the THS4509 outputs and ADS5474 inputs (along with the input capacitance of the ADC) limit the bandwidth of the signal to about 70 MHz (-3 dB). Input termination is accomplished via the 78.9- Ω resistor and 0.22- μ F capacitor to ground, in conjunction with the input impedance of the amplifier circuit. A 0.22- μ F capacitor and 49.9- Ω resistor are inserted to ground across the 78.9- Ω resistor and 0.22- μ F capacitor on the alternate input to balance the circuit. Gain is a function of the source impedance, termination, and 348- Ω feedback resistor. See the [THS4509 data sheet](#) for further component values to set proper 50- Ω termination for other common gains. Because the ADS5474 recommended input common-mode voltage is 3.1 V, the THS4509 operates from a single power-supply input with $V_{S+} = 5$ V and $V_{S-} = 0$ V (ground). This configuration has the potential to slightly exceed the recommended output voltage from the THS4509 of 3.6V due to the ADC input common-mode of 3.1V and the +0.55V full-scale signal. This will not harm the THS4509 but may result in a degradation in the harmonic performance of the THS4509. An amplifier with a wider recommended output voltage range is the THS4520, which is optimized for low noise and low distortion in the range of frequencies up to \sim 20MHz. Applications that are not sensitive to harmonic distortion could consider either device at higher frequencies.

External Voltage Reference

For systems that require the analog signal gain to be adjusted or calibrated, this can be performed by using an external reference. The dependency on the signal amplitude to the value of the external reference voltage is characterized typically by [Figure 35](#) (VREF = 2.4 V is normalized to 0 dB as this is the internal reference voltage). As can be seen in the linear fit, this equates to approximately -0.3 dB of signal adjustment per 100 mV of reference adjustment. The range of allowable variation depends on the analog input amplitude that is applied to the inputs and the desired spectral performance, as can be seen in the performance versus external reference graphs in [Figure 36](#) and [Figure 37](#). As the applied analog signal amplitude is reduced, more variation in the reference voltage is allowed in the positive direction (which equates to a reduction in signal amplitude), whereas an adjustment in reference voltage below the nominal 2.4 V (which equates to an increase in signal amplitude) is not recommended below approximately 2.35 V. The power consumption versus reference voltage and operating temperature should also be considered, especially at high ambient temperatures, because the lifetime of the device is affected by internal junction temperature, see [Figure 50](#).

For dc-coupled applications that use the VCM pin of the ADS5474 as the common mode of the signal in the analog signal gain path prior to the ADC inputs, the information in [Figure 39](#) is useful to consider versus the allowable common-mode range of the device that is receiving the VCM voltage, such as an operational amplifier. Because it is pin-compatible, it is important to note that the ADS5463 does not have a VCM pin and primarily uses the VREF pin to provide the common-mode voltage in dc-coupled applications. The ADS5463 (VCM = 2.4 V) and ADS5474 (VCM = 3.1V) do not have the same common-mode voltage. To create a board layout that may accommodate both devices in dc-coupled applications, route VCM and VREF both to a common point that can be selected via a switch, jumper, or a 0 Ω resistor.

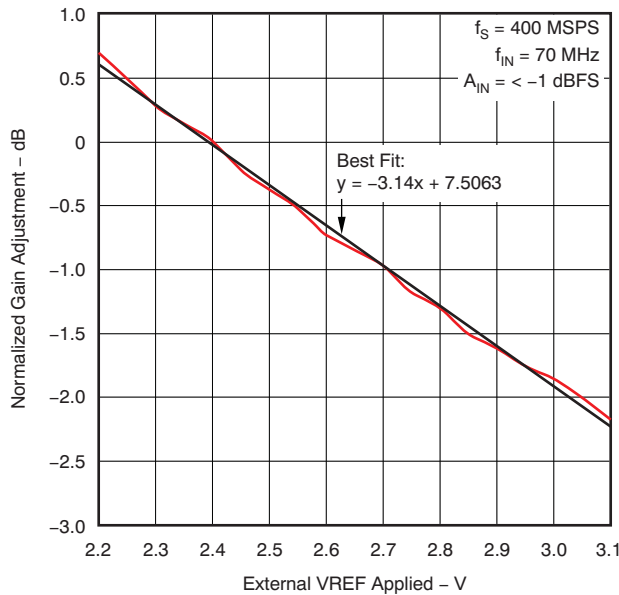

Figure 35. Signal Gain Adjustment versus External Reference (VREF)

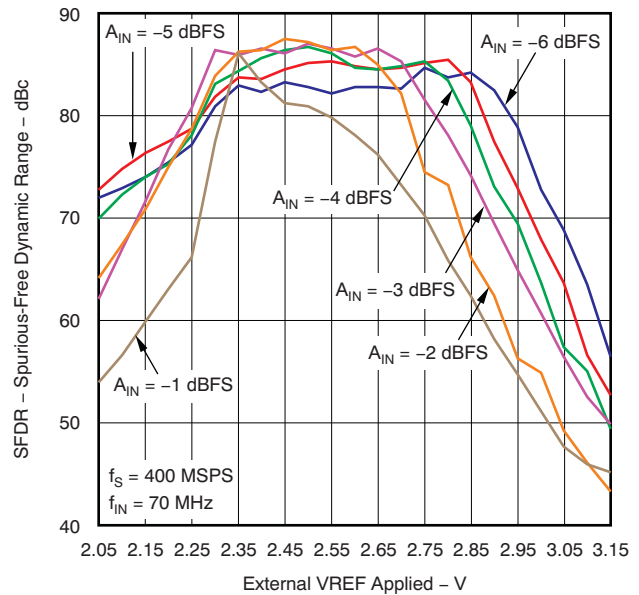

Figure 36. SFDR versus External VREF and AIN

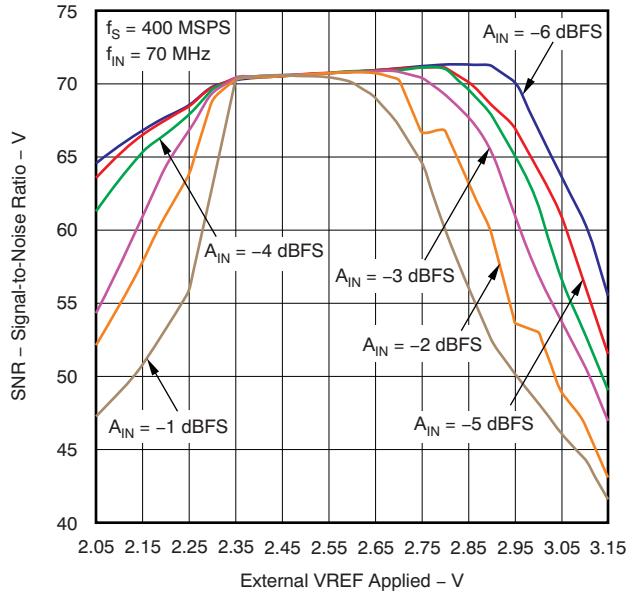

Figure 37. SNR versus External VREF and A_{IN}

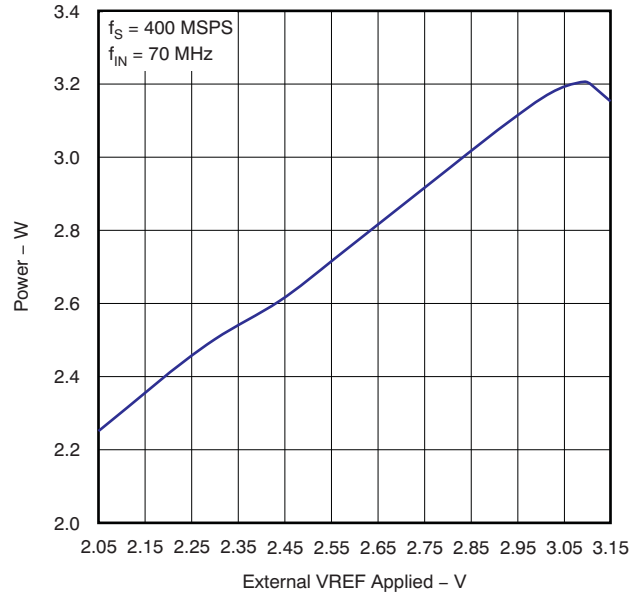

Figure 38. Total Power Consumption versus External VREF

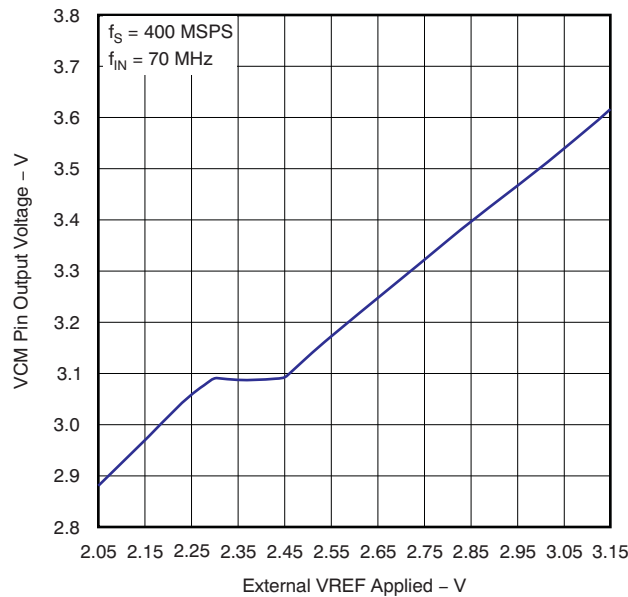
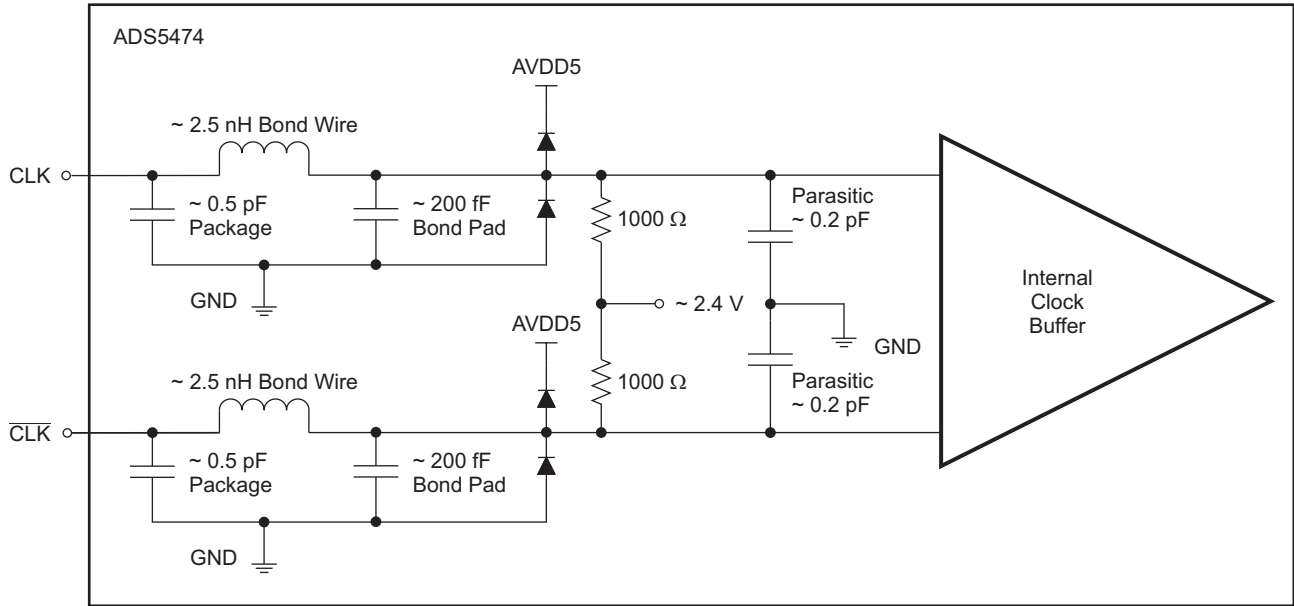

Figure 39. VCM Pin Output versus External VREF

Clock Inputs

The ADS5474 clock input can be driven with either a differential clock signal or a single-ended clock input. The characterization of the ADS5474 is typically performed with a 3- V_{PP} differential clock, but the ADC performs well with a differential clock amplitude down to $\sim 0.5 V_{PP}$, as shown in Figure 42. The clock amplitude becomes more of a factor in performance as the analog input frequency increases. In low-input-frequency applications, where jitter may not be a big concern, the use of a single-ended clock could save cost and board space without much performance tradeoff. When clocked with this configuration, it is best to connect \overline{CLK} to ground with a 0.01- μF capacitor, while CLK is ac-coupled with a 0.01- μF capacitor to the clock source, as shown in Figure 41.



S0292-04

Figure 40. Clock Input Circuit

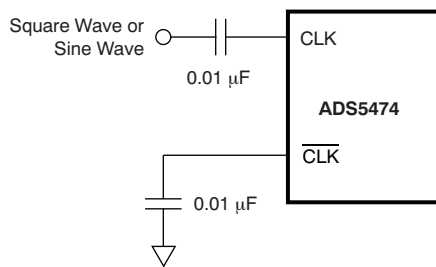

Figure 41. Single-Ended Clock

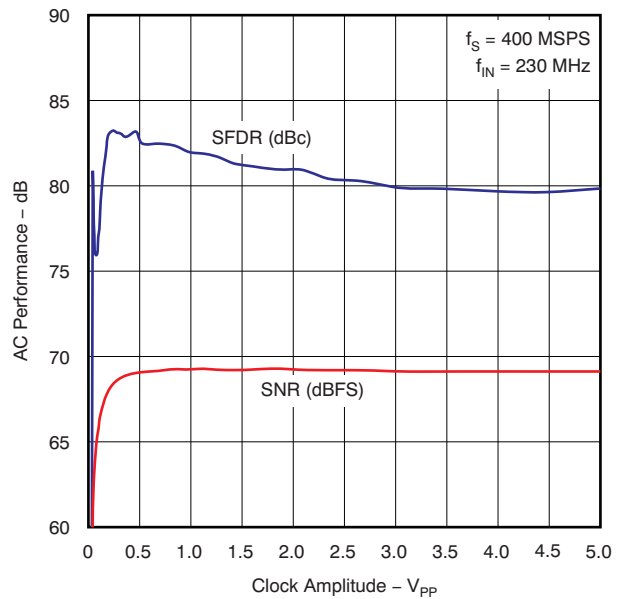

Figure 42. AC Performance versus Clock Level

For jitter-sensitive applications, the use of a differential clock has some advantages at the system level. The differential clock allows for common-mode noise rejection at the printed circuit board (PCB) level. With a differential clock, the signal-to-noise ratio of the ADC is better for jitter-sensitive, high-frequency applications because the board level clock jitter is superior.

Larger clock amplitude levels are recommended for high analog input frequencies or slow clock frequencies. In the case of a sinusoidal clock, larger amplitudes result in higher clock slew rates and reduces the impact of clock noise on jitter. At high analog input frequencies, the sampling process is sensitive to jitter. And at slow clock frequencies, a small amplitude sinusoidal clock has a lower slew rate and can create jitter-related SNR degradation. Figure 43 demonstrates a recommended method for converting a single-ended clock source into a differential clock; it is similar to the configuration found on the evaluation board and was used for much of the characterization. See also *Clocking High Speed Data Converters (SLYT075)* for more details.

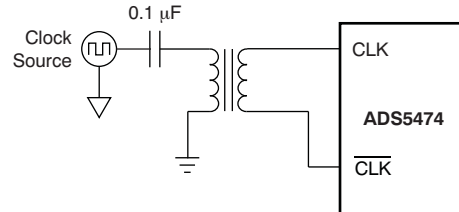

Figure 43. Differential Clock

The common-mode voltage of the clock inputs is set internally to 2.4 V using internal 1-kΩ resistors. It is recommended to use ac coupling, but if this scheme is not possible, the ADS5474 features good tolerance to clock common-mode variation (as shown in Figure 44 and Figure 45). Additionally, the internal ADC core uses both edges of the clock for the conversion process. Ideally, a 50% duty-cycle clock signal should be provided. Performance degradation as a result of duty cycle can be seen in Figure 46.

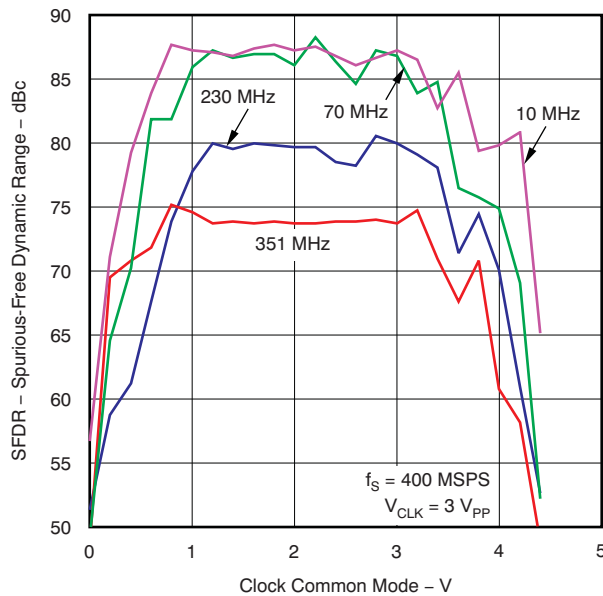

Figure 44. SFDR versus Clock Common Mode

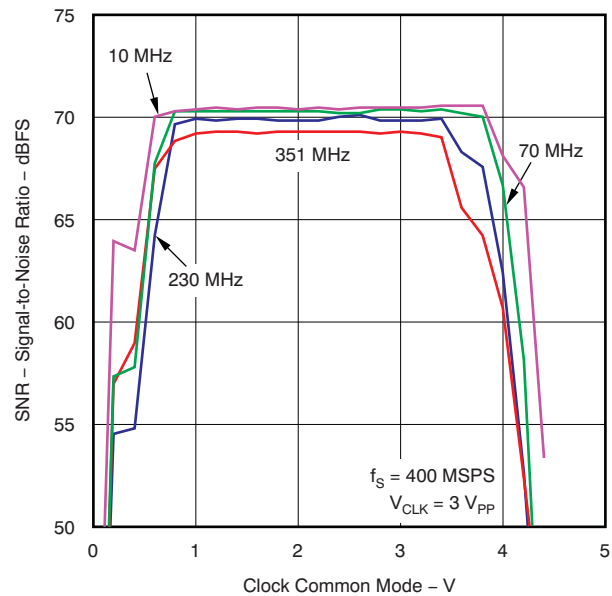

Figure 45. SNR versus Clock Common Mode

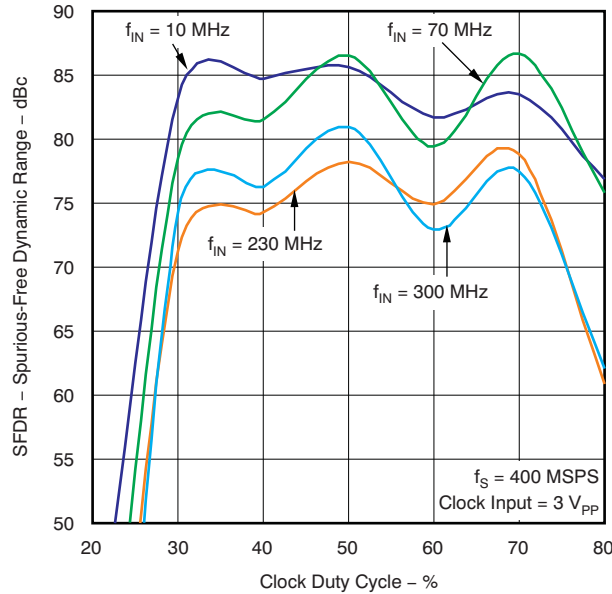

Figure 46. SFDR vs Clock Duty Cycle

The ADS5474 is capable of achieving 69.2 dBFS SNR at 350 MHz of analog input frequency. In order to achieve the SNR at 350 MHz the clock source rms jitter must be at least 144 fsec in order for the total rms jitter to be 177 fsec. A summary of maximum recommended rms clock jitter as a function of analog input frequency is provided in [Table 3](#). The equations used to create the table are also presented.

Table 3. Recommended RMS Clock Jitter

INPUT FREQUENCY (MHz)	MEASURED SNR (dBc)	TOTAL JITTER (fsec rms)	MAXIMUM CLOCK JITTER (fsec rms)
30	69.3	1818	1816
70	69.1	798	791
130	69.1	429	417
230	68.8	251	229
350	68.2	177	144
450	67.4	151	110
750	65.6	111	42
1000	63.7	104	14

[Equation 1](#) and [Equation 2](#) are used to estimate the required clock source jitter.

$$SNR \text{ (dBc)} = -20 \times \text{LOG}_{10} (2 \times \pi \times f_{IN} \times j_{TOTAL}) \tag{1}$$

$$j_{TOTAL} = (j_{ADC}^2 + j_{CLOCK}^2)^{1/2} \tag{2}$$

where:

- j_{TOTAL} = the rms summation of the clock and ADC aperture jitter;
- j_{ADC} = the ADC internal aperture jitter which is located in the data sheet;
- j_{CLOCK} = the rms jitter of the clock at the clock input pins to the ADC; and
- f_{IN} = the analog input frequency.

Notice that the SNR is a strong function of the analog input frequency, not the clock frequency. The slope of the clock source edges can have a mild impact on SNR as well and is not taken into account for these estimates. For this reason, maximizing clock source amplitudes at the ADC clock inputs is recommended, though not required (faster slope is desirable for jitter-related SNR). For more information on clocking high-speed ADCs, see Application Note [SLWA034, Implementing a CDC7005 Low Jitter Clock Solution For High-Speed, High-IF ADC](#)

Devices, on the Texas Instruments web site. Recommended clock distribution chips (CDCs) are the TI CDC7005, the CDCM7005 and CDCE72010. Depending on the jitter requirements, a band pass filter (BPF) is sometimes required between the CDC and the ADC. If the insertion loss of the BPF causes the clock amplitude to be too low for the ADC, or the clock source amplitude is too low to begin with, an inexpensive amplifier can be placed between the CDC and the BPF.

Figure 47 represents a scenario where an LVCMOS single-ended clock output is used from a TI CDCM7005 with the clock signal path optimized for maximum amplitude and minimum jitter. This type of conditioning might generally be well-suited for use with greater than 150 MHz of input frequency. The jitter of this setup is difficult to estimate and requires a careful phase noise analysis of the clock path. The BPF (and possibly a low-cost amplifier because of insertion loss in the BPF) can improve the jitter between the CDC and ADC when the jitter provided by the CDC is still not adequate. The total jitter at the CDCM7005 output depends largely on the phase noise of the VCXO selected, as well as the CDCM7005, and typically has 50–100 fs of rms jitter. If it is determined that the jitter from the CDCM7005 with a VCXO is sufficient without further conditioning, it is possible to clock the ADS5474 directly from the CDCM7005 using differential LVPECL outputs, as illustrated in Figure 48 (see the CDCM7005 data sheet for the exact schematic). This scenario may be more suitable for less than 150 MHz of input frequency where jitter is not as critical. A careful analysis of the required jitter is recommended before determining the proper approach.

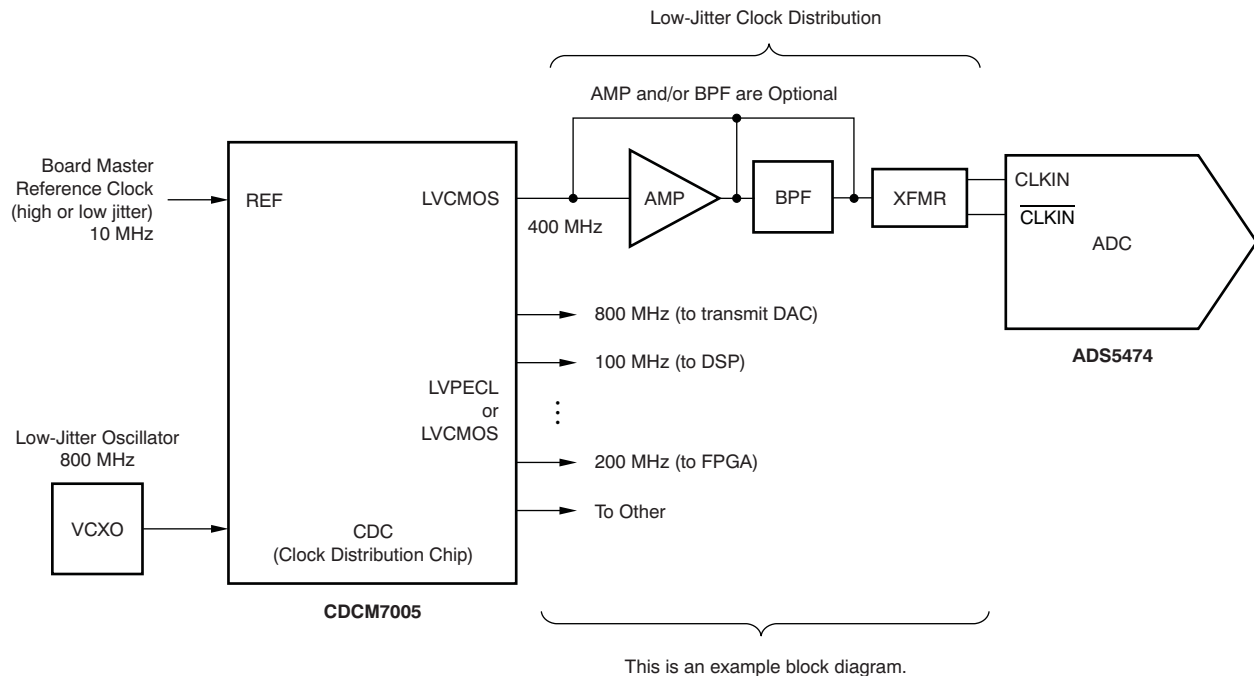

Consult the CDCM7005 data sheet for proper schematic and specifications regarding allowable input and output frequency and amplitude ranges.

Figure 47. Optimum Jitter Clock Circuit

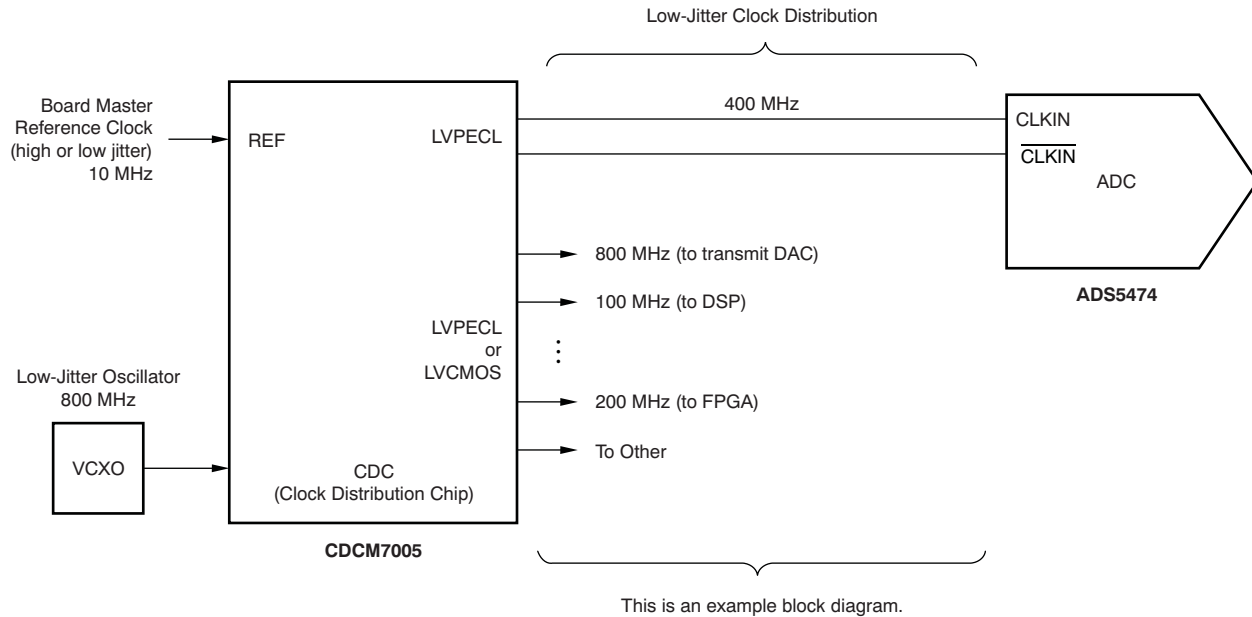

Consult the [CDCM7005 data sheet](#) for proper schematic and specifications regarding allowable input and output frequency and amplitude ranges.

Figure 48. Acceptable Jitter Clock Circuit

Digital Outputs

The ADC provides 14 LVDS-compatible, offset binary data outputs (D13 to D0; D13 is the MSB and D0 is the LSB), a data-ready signal (DRY), and an over-range indicator (OVR). It is recommended to use the DRY signal to capture the output data of the ADS5474. DRY is source-synchronous to the DATA/OVR outputs and operates at the same frequency, creating a half-rate DDR interface that updates data on both the rising and falling edges of DRY. It is recommended that the capacitive loading on the digital outputs be minimized. Higher capacitance shortens the data-valid timing window. The values given for timing (see [Figure 1](#)) were obtained with a measured 10-pF parasitic board capacitance to ground on each LVDS line (or 5-pF differential parasitic capacitance). When setting the time relationship between DRY and DATA at the receiving device, it is generally recommended that setup time be maximized, but this partially depends on the setup and hold times of the device receiving the digital data (like an FPGA or Field Programmable Field Array). Since DRY and DATA are coincident, it will likely be necessary to delay either DRY or DATA such that setup time is maximized.

Referencing [Figure 1](#), the polarity of DRY with respect to the sample N data output transition is undetermined because of the unknown startup logic level of the clock divider that generates the DRY signal (DRY is a frequency divide-by-two of CLK). Either the rising or the falling edge of DRY will be coincident with sample N and the polarity of DRY could invert when power is cycled off/on or when the power-down pin is cycled. Data capture from the transition and not the polarity of DRY is recommended, but not required. If the synchronization of multiple ADS5474 devices is required, it might be necessary to use a form of the CLKIN signal rather than DRY to capture the data.

The DRY frequency is identical on the ADS5474 and ADS5463 (where DRY equals $\frac{1}{2}$ the CLK frequency), but different than it is on the pin-similar ADS5444/ADS5440 (where DRY equals the CLK frequency). The LVDS outputs all require an external 100- Ω load between each output pair in order to meet the expected LVDS voltage levels. For long trace lengths, it may be necessary to place a 100- Ω load on each digital output as close to the ADS5474 as possible and another 100- Ω differential load at the end of the LVDS transmission line to provide matched impedance and avoid signal reflections. The effective load in this case reduces the LVDS voltage levels by half.

The OVR output equals a logic high when the 14-bit output word attempts to exceed either all 0s or all 1s. This flag is provided as an indicator that the analog input signal exceeded the full-scale input limit of approximately $2.2 V_{PP}$ (\pm gain error). The OVR indicator is provided for systems that use gain control to keep the analog input signal within acceptable limits.

Power Supplies

The ADS5474 uses three power supplies. For the analog portion of the design, a 5-V and 3.3-V supply (AVDD5 and AVDD3) are used, while the digital portion uses a 3.3-V supply (DVDD3). The use of low-noise power supplies with adequate decoupling is recommended. Linear supplies are preferred to switched supplies; switched supplies tend to generate more noise components that can be coupled to the ADS5474. However, the PSRR value and the plot shown in Figure 49 were obtained without bulk supply decoupling capacitors. When bulk (0.1 μ F) decoupling capacitors are used, the board-level PSRR is much higher than the stated value for the ADC. The user may be able to supply power to the device with a less-than-ideal supply and still achieve good performance. It is not possible to make a single recommendation for every type of supply and level of decoupling for all systems. If the noise characteristics of the available supplies are understood, a study of the PSRR data for the ADS5474 may provide the user with enough information to select noisy supplies if the performance is still acceptable within the frequency range of interest. The power consumption of the ADS5474 does not change substantially over clock rate or input frequency as a result of the architecture and process. The DVDD3 PSRR is superior to both the AVDD5 and AVDD3 so was not graphed.

Because there are two diodes connected in reverse between AVDD3 and DVDD3 internally, a power-up sequence is recommended. When there is a delay in power up between these two supplies, the one that lags could have current sinking through an internal diode before it powers up. The sink current can be large or small depending on the impedance of the external supply and could damage the device or affect the supply source. The best power up sequence is one of the following options (regardless of when AVDD5 powers up):

- 1) Power up both AVDD3 and DVDD3 at the same time (best scenario), OR
- 2) Keep the voltage difference less than 0.8V between AVDD3 and DVDD3 during the power up (0.8V is not a hard specification - a smaller delta between supplies is safer).

If the above sequences are not practical then the sink current from the supply needs to be controlled or protection added externally. The max transient current (on the order of μ sec) for DVDD3 or AVDD3 pin is 500mA to avoid potential damage to the device or reduce its lifetime.

Values for analog and clock input given in the [Absolute Maximum Ratings](#) are valid when the supplies are on. When the power supplies are off and the clock or analog inputs are still alive, the input voltage and current needs to be limited to avoid device damage. If the ADC supplies are off, the max/min continuous DC voltage is +/- 0.95 V and max DC current is 20 mA for each input pin (clock or analog), relative to ground.

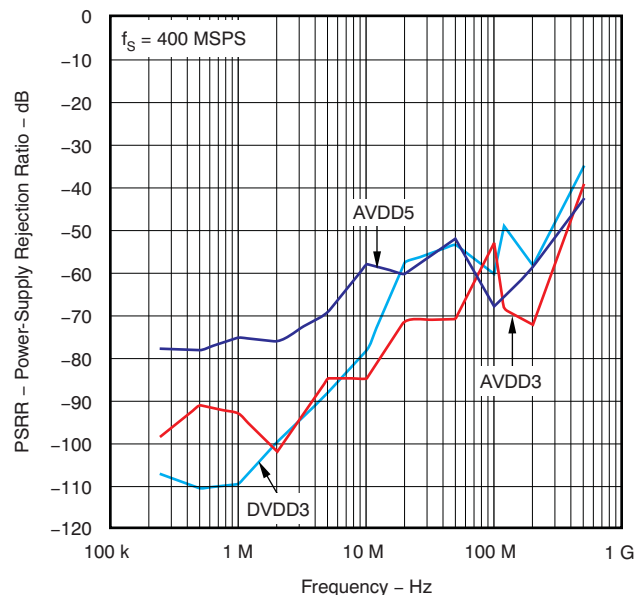

Figure 49. PSRR versus Supply Injected Frequency

Operational Lifetime

It is important for applications that anticipate running continuously for long periods of time near the maximum-rated ambient temperature of +85°C to consider the data shown in [Figure 50](#). Referring to the [Thermal Characteristics](#) table, the worst-case operating condition with no airflow has a thermal rise of 23.7°C/W. At approximately 2.5 W of normal power dissipation, at a maximum ambient of +85°C with no airflow, the junction temperature of the ADS5474 reaches approximately +85°C + 23.7°C/W × 2.5 W = +144°C. Being even more conservative and accounting for the maximum possible power dissipation that is ensured (2.797 W), the junction temperature becomes nearly +150°C. As [Figure 50](#) shows, this performance limits the expected lifetime of the ADS5474. Operation at +85°C continuously may require airflow or an additional heatsink in order to decrease the internal junction temperature and increase the expected lifetime (because of electromigration failures). An airflow of 250 LFM (linear feet per minute) reduces the thermal resistance to 16.4°C/W and, therefore, the maximum junction temperature to +131°C, assuming a worst-case of 2.797 W and +85°C ambient.

The ADS5474 performance over temperature is quite good and can be seen starting in [Figure 21](#). Though the typical plots show good performance at +100°C, the device is only rated from –40°C to +85°C. For continuous operation at temperatures near or above the maximum, the expected primary negative effect is a shorter device lifetime because of the electromigration failures at high junction temperatures. The maximum recommended continuous junction temperature is +150°C.

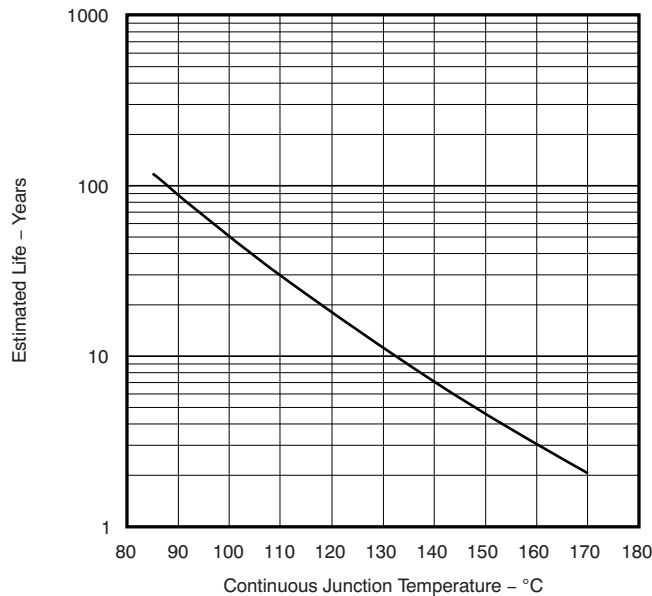

Figure 50. Operating Life Derating Chart, Electromigration Fail Mode

Layout Information

The evaluation board represents a good model of how to lay out the printed circuit board (PCB) to obtain the maximum performance from the ADS5474. Follow general design rules, such as the use of multilayer boards, a single ground plane for ADC ground connections, and local decoupling ceramic chip capacitors. The analog input traces should be isolated from any external source of interference or noise, including the digital outputs as well as the clock traces. The clock signal traces should also be isolated from other signals, especially in applications such as high IF sampling where low jitter is required. Besides performance-oriented rules, care must be taken when considering the heat dissipation of the device. The thermal heatsink included on the bottom of the package should be soldered to the board as described in the [PowerPad Package](#) section. See the *ADS5474 EVM User Guide* (SLAU194) on the [TI web site](#) for the evaluation board schematic.

PowerPAD Package

The PowerPAD package is a thermally-enhanced, standard-size IC package designed to eliminate the use of bulky heatsinks and slugs traditionally used in thermal packages. This package can be easily mounted using standard PCB assembly techniques, and can be removed and replaced using standard repair procedures.

The PowerPAD package is designed so that the leadframe die pad (or thermal pad) is exposed on the bottom of the IC. This pad design provides an extremely low thermal resistance path between the die and the exterior of the package. The thermal pad on the bottom of the IC can then be soldered directly to the PCB, using the PCB as a heatsink.

Assembly Process

1. Prepare the PCB top-side etch pattern including etch for the leads as well as the thermal pad as illustrated in the Mechanical Data section (at the end of this data sheet).
2. Place a 6-by-6 array of thermal vias in the thermal pad area. These holes should be 13 mils (0.013 in or 0.3302 mm) in diameter. The small size prevents wicking of the solder through the holes.
3. It is recommended to place a small number of 25 mil (0.025 in or 0.635 mm) diameter holes under the package, but outside the thermal pad area, to provide an additional heat path.
4. Connect all holes (both those inside and outside the thermal pad area) to an internal copper plane (such as a ground plane).
5. Do not use the typical web or spoke via-connection pattern when connecting the thermal vias to the ground plane. The spoke pattern increases the thermal resistance to the ground plane.
6. The top-side solder mask should leave exposed the terminals of the package and the thermal pad area.
7. Cover the entire bottom side of the PowerPAD vias to prevent solder wicking.
8. Apply solder paste to the exposed thermal pad area and all of the package terminals.

For more detailed information regarding the PowerPAD package and its thermal properties, see either the *PowerPAD Made Easy* application brief (SLMA004) or the *PowerPAD Thermally Enhanced Package* application report (SLMA002), both available for download at www.ti.com.

DEFINITION OF SPECIFICATIONS

Analog Bandwidth

The analog input frequency at which the power of the fundamental is reduced by 3 dB with respect to the low-frequency value.

Aperture Delay

The delay in time between the rising edge of the input sampling clock and the actual time at which the sampling occurs.

Aperture Uncertainty (Jitter)

The sample-to-sample variation in aperture delay.

Clock Pulse Duration/Duty Cycle

The duty cycle of a clock signal is the ratio of the time the clock signal remains at a logic high (clock pulse duration) to the period of the clock signal, expressed as a percentage.

Differential Nonlinearity (DNL)

An ideal ADC exhibits code transitions at analog input values spaced exactly 1 LSB apart. DNL is the deviation of any single step from this ideal value, measured in units of LSB.

Common-Mode Rejection Ratio (CMRR)

CMRR measures the ability to reject signals that are presented to both analog inputs simultaneously. The injected common-mode frequency level is translated into dBFS, the spur in the output FFT is measured in dBFS, and the difference is the CMRR in dB.

Effective Number of Bits (ENOB)

ENOB is a measure in units of bits of converter performance as compared to the theoretical limit based on quantization noise:

$$\text{ENOB} = (\text{SINAD} - 1.76)/6.02 \quad (3)$$

Gain Error

Gain error is the deviation of the ADC actual input full-scale range from its ideal value, given as a percentage of the ideal input full-scale range.

Integral Nonlinearity (INL)

INL is the deviation of the ADC transfer function from a best-fit line determined by a least-squares curve fit of that transfer function. The INL at each analog input value is the difference between the actual transfer function and this best-fit line, measured in units of LSB.

Offset Error

Offset error is the deviation of output code from mid-code when both inputs are tied to common-mode.

Power-Supply Rejection Ratio (PSRR)

PSRR is a measure of the ability to reject frequencies present on the power supply.

The injected frequency level is translated into dBFS, the spur in the output FFT is measured in dBFS, and the difference is the PSRR in dB. The measurement calibrates out the benefit of the board supply decoupling capacitors.

Signal-to-Noise Ratio (SNR)

SNR is the ratio of the power of the fundamental (P_S) to the noise floor power (P_N), excluding the power at dc and in the first five harmonics.

$$\text{SNR} = 10 \log_{10} \frac{P_S}{P_N} \quad (4)$$

SNR is either given in units of dBc (dB to carrier) when the absolute power of the fundamental is used as the reference, or dBFS (dB to full-scale) when the power of the fundamental is extrapolated to the converter full-scale range.

Signal-to-Noise and Distortion (SINAD)

SINAD is the ratio of the power of the fundamental (P_S) to the power of all the other spectral components including noise (P_N) and distortion (P_D), but excluding dc.

$$\text{SINAD} = 10 \log_{10} \frac{P_S}{P_N + P_D} \quad (5)$$

SINAD is either given in units of dBc (dB to carrier) when the absolute power of the fundamental is used as the reference, or dBFS (dB to full-scale) when the power of the fundamental is extrapolated to the converter full-scale range.

Temperature Drift

Temperature drift (with respect to gain error and offset error) specifies the change from the value at the nominal temperature to the value at T_{MIN} or T_{MAX} . It is computed as the maximum variation of the parameters over the whole temperature range divided by $T_{\text{MIN}} - T_{\text{MAX}}$.

Total Harmonic Distortion (THD)

THD is the ratio of the power of the fundamental (P_S) to the power of the first five harmonics (P_D).

$$\text{THD} = 10 \log_{10} \frac{P_S}{P_D} \quad (6)$$

THD is typically given in units of dBc (dB to carrier).

Two-Tone Intermodulation Distortion (IMD3)

IMD3 is the ratio of the power of the fundamental (at frequencies f_1 , f_2) to the power of the worst spectral component at either frequency $2f_1 - f_2$ or $2f_2 - f_1$. IMD3 is given in units of either dBc (dB to carrier) when the absolute power of the fundamental is used as the reference, or dBFS (dB to full-scale) when the power of the fundamental is extrapolated to the converter full-scale range.

REVISION HISTORY

Changes from Revision A (August 2008) to Revision B	Page
• Changed 1.6pF to 2.3pF TYP Input capacitance in ELECTRICAL CHARACTERISTICS	3
• Changed (where DRY equals the CLK frequency) to (where DRY equals ½ the CLK frequency) in Digital Outputs section	28

PACKAGING INFORMATION

Orderable Device	Status ⁽¹⁾	Package Type	Package Drawing	Pins	Package Qty	Eco Plan ⁽²⁾	Lead/Ball Finish	MSL Peak Temp ⁽³⁾
ADS5474IPFP	ACTIVE	HTQFP	PFP	80	96	Green (RoHS & no Sb/Br)	CU NIPDAU	Level-4-260C-72 HR
ADS5474IPFPG4	ACTIVE	HTQFP	PFP	80	96	Green (RoHS & no Sb/Br)	CU NIPDAU	Level-4-260C-72 HR
ADS5474IPFPR	ACTIVE	HTQFP	PFP	80	1000	Green (RoHS & no Sb/Br)	CU NIPDAU	Level-4-260C-72 HR
ADS5474IPFPRG4	ACTIVE	HTQFP	PFP	80	1000	Green (RoHS & no Sb/Br)	CU NIPDAU	Level-4-260C-72 HR

⁽¹⁾ The marketing status values are defined as follows:

ACTIVE: Product device recommended for new designs.

LIFEBUY: TI has announced that the device will be discontinued, and a lifetime-buy period is in effect.

NRND: Not recommended for new designs. Device is in production to support existing customers, but TI does not recommend using this part in a new design.

PREVIEW: Device has been announced but is not in production. Samples may or may not be available.

OBSOLETE: TI has discontinued the production of the device.

⁽²⁾ Eco Plan - The planned eco-friendly classification: Pb-Free (RoHS), Pb-Free (RoHS Exempt), or Green (RoHS & no Sb/Br) - please check <http://www.ti.com/productcontent> for the latest availability information and additional product content details.

TBD: The Pb-Free/Green conversion plan has not been defined.

Pb-Free (RoHS): TI's terms "Lead-Free" or "Pb-Free" mean semiconductor products that are compatible with the current RoHS requirements for all 6 substances, including the requirement that lead not exceed 0.1% by weight in homogeneous materials. Where designed to be soldered at high temperatures, TI Pb-Free products are suitable for use in specified lead-free processes.

Pb-Free (RoHS Exempt): This component has a RoHS exemption for either 1) lead-based flip-chip solder bumps used between the die and package, or 2) lead-based die adhesive used between the die and leadframe. The component is otherwise considered Pb-Free (RoHS compatible) as defined above.

Green (RoHS & no Sb/Br): TI defines "Green" to mean Pb-Free (RoHS compatible), and free of Bromine (Br) and Antimony (Sb) based flame retardants (Br or Sb do not exceed 0.1% by weight in homogeneous material)

⁽³⁾ MSL, Peak Temp. -- The Moisture Sensitivity Level rating according to the JEDEC industry standard classifications, and peak solder temperature.

Important Information and Disclaimer:The information provided on this page represents TI's knowledge and belief as of the date that it is provided. TI bases its knowledge and belief on information provided by third parties, and makes no representation or warranty as to the accuracy of such information. Efforts are underway to better integrate information from third parties. TI has taken and continues to take reasonable steps to provide representative and accurate information but may not have conducted destructive testing or chemical analysis on incoming materials and chemicals. TI and TI suppliers consider certain information to be proprietary, and thus CAS numbers and other limited information may not be available for release.

In no event shall TI's liability arising out of such information exceed the total purchase price of the TI part(s) at issue in this document sold by TI to Customer on an annual basis.

TAPE AND REEL INFORMATION

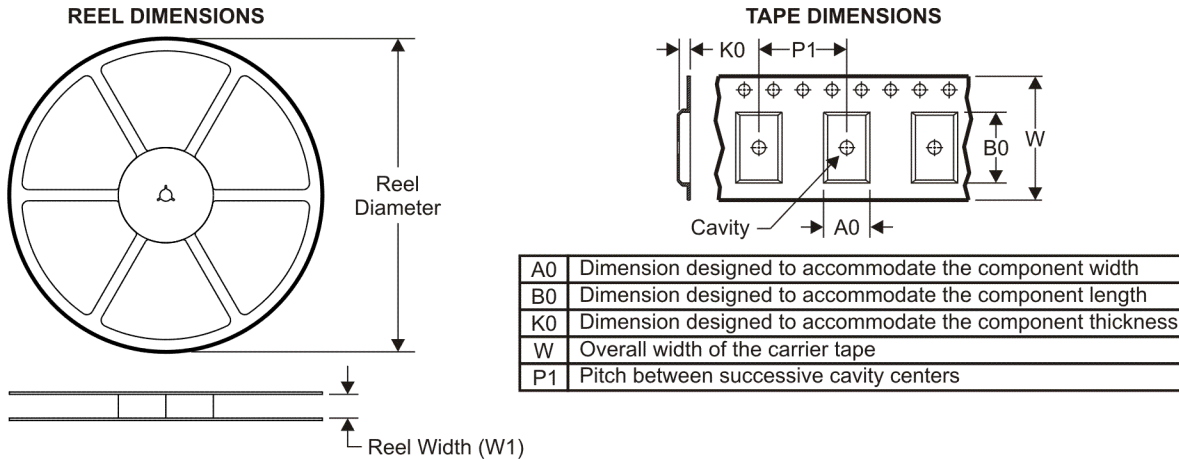

QUADRANT ASSIGNMENTS FOR PIN 1 ORIENTATION IN TAPE

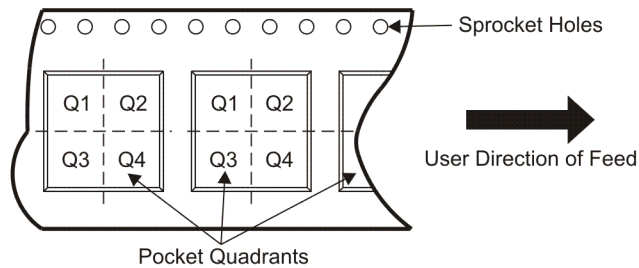

*All dimensions are nominal

Device	Package Type	Package Drawing	Pins	SPQ	Reel Diameter (mm)	Reel Width W1 (mm)	A0 (mm)	B0 (mm)	K0 (mm)	P1 (mm)	W (mm)	Pin1 Quadrant
ADS5474IPFPR	HTQFP	PFP	80	1000	330.0	24.4	15.0	15.0	1.5	20.0	24.0	Q2

TAPE AND REEL BOX DIMENSIONS



*All dimensions are nominal

Device	Package Type	Package Drawing	Pins	SPQ	Length (mm)	Width (mm)	Height (mm)
ADS5474IPFPR	HTQFP	PFP	80	1000	346.0	346.0	41.0

MECHANICAL DATA

PFP (S-PQFP-G80)

PowerPAD™ PLASTIC QUAD FLATPACK

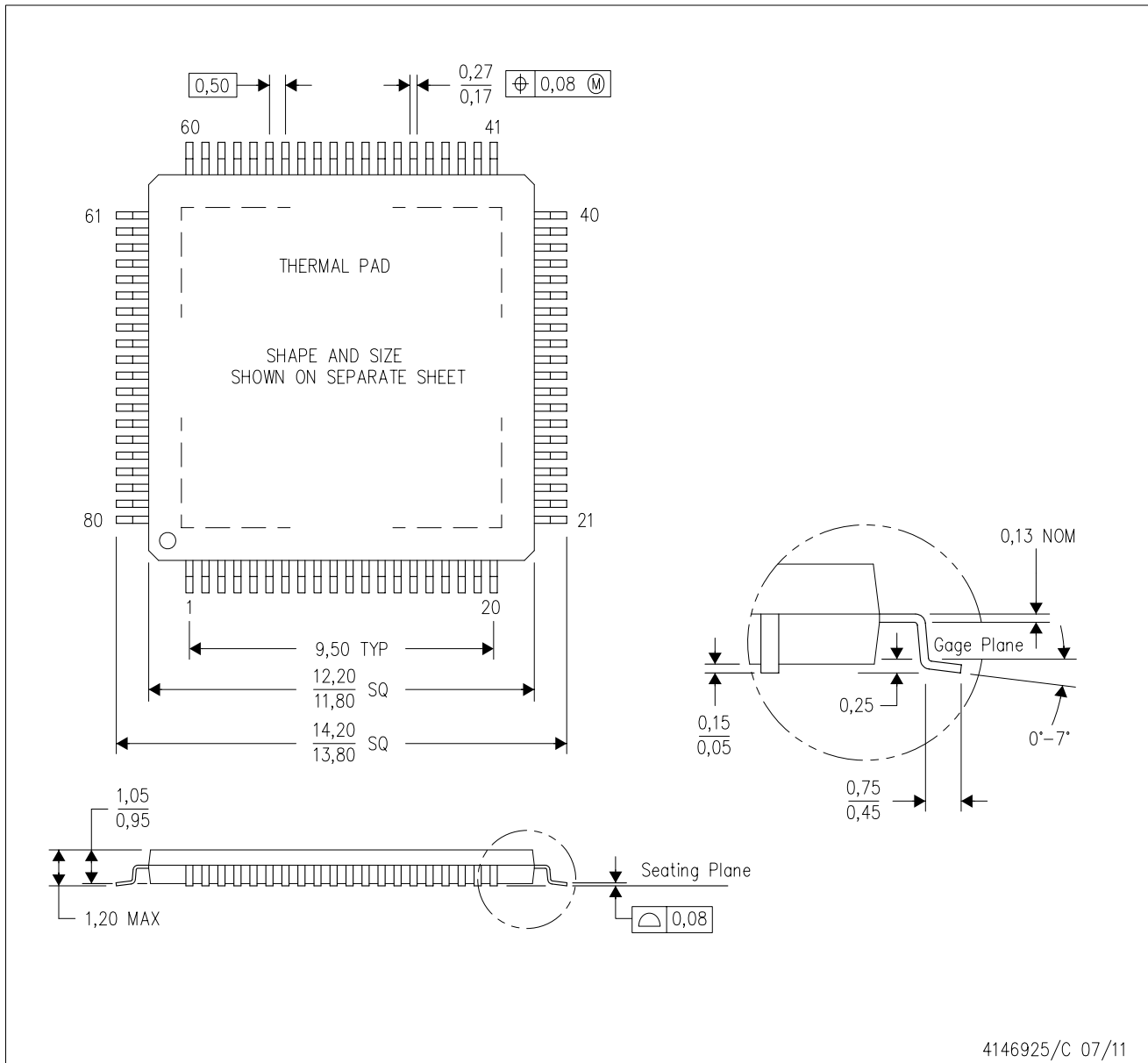

- NOTES:
- A. All linear dimensions are in millimeters.
 - B. This drawing is subject to change without notice.
 - C. Body dimensions do not include mold flash or protrusion
 - D. This package is designed to be soldered to a thermal pad on the board. Refer to Technical Brief, PowerPad Thermally Enhanced Package, Texas Instruments Literature No. SLMA002 for information regarding recommended board layout. This document is available at www.ti.com <<http://www.ti.com>>.
 - E. See the additional figure in the Product Data Sheet for details regarding the exposed thermal pad features and dimensions.
 - F. Falls within JEDEC MS-026

PowerPAD is a trademark of Texas Instruments.

THERMAL PAD MECHANICAL DATA

PFP (S-PQFP-G80)

PowerPAD™ PLASTIC QUAD FLATPACK

THERMAL INFORMATION

This PowerPAD™ package incorporates an exposed thermal pad that is designed to be attached to a printed circuit board (PCB). The thermal pad must be soldered directly to the PCB. After soldering, the PCB can be used as a heatsink. In addition, through the use of thermal vias, the thermal pad can be attached directly to the appropriate copper plane shown in the electrical schematic for the device, or alternatively, can be attached to a special heatsink structure designed into the PCB. This design optimizes the heat transfer from the integrated circuit (IC).

For additional information on the PowerPAD package and how to take advantage of its heat dissipating abilities, refer to Technical Brief, PowerPAD Thermally Enhanced Package, Texas Instruments Literature No. SLMA002 and Application Brief, PowerPAD Made Easy, Texas Instruments Literature No. SLMA004. Both documents are available at www.ti.com.

The exposed thermal pad dimensions for this package are shown in the following illustration.

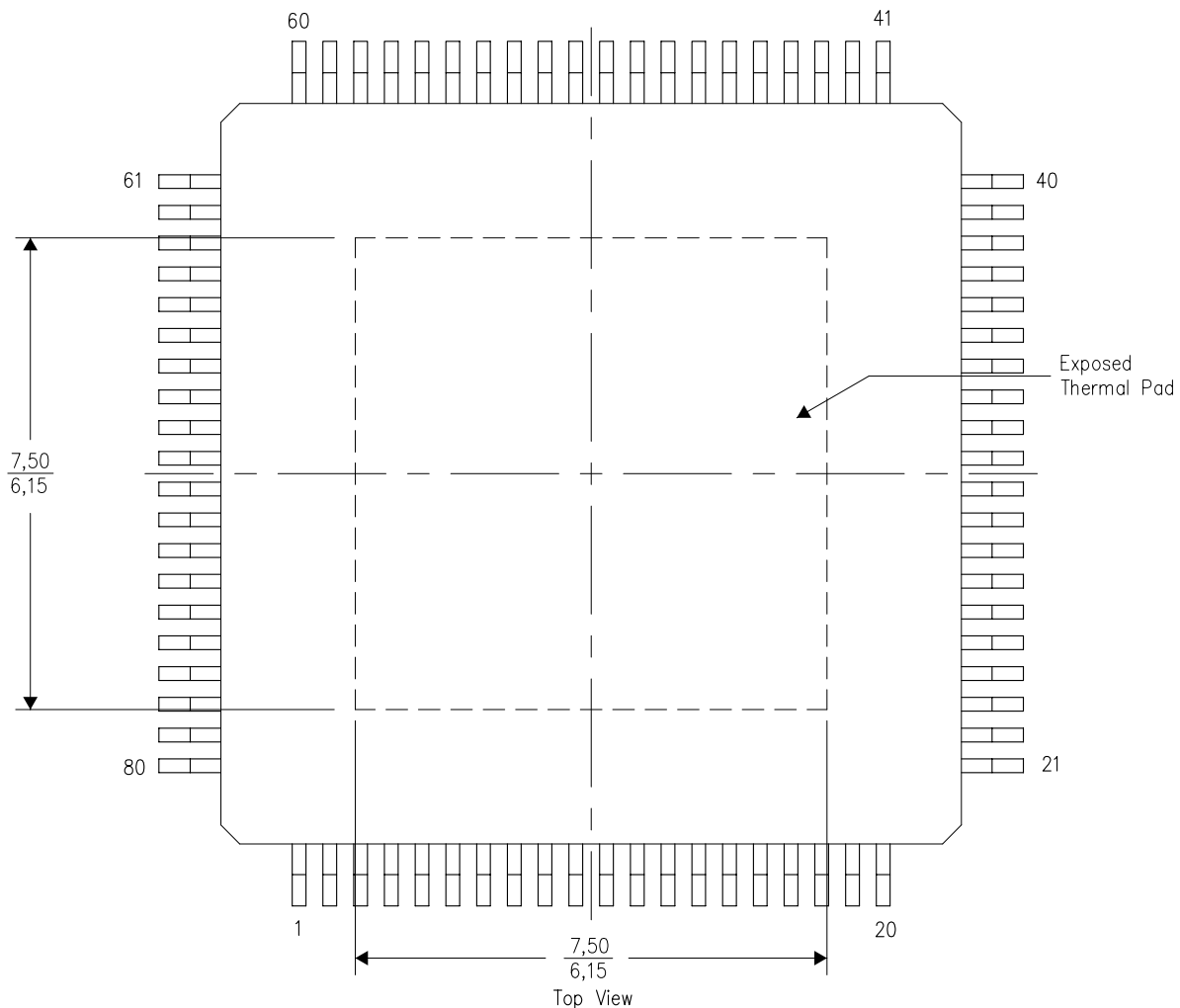

Exposed Thermal Pad Dimensions

4206327-2/N 09/11

NOTE: A. All linear dimensions are in millimeters

PowerPAD is a trademark of Texas Instruments

LAND PATTERN DATA

PFP (S-PQFP-G80)

PowerPAD™ PLASTIC QUAD FLATPACK

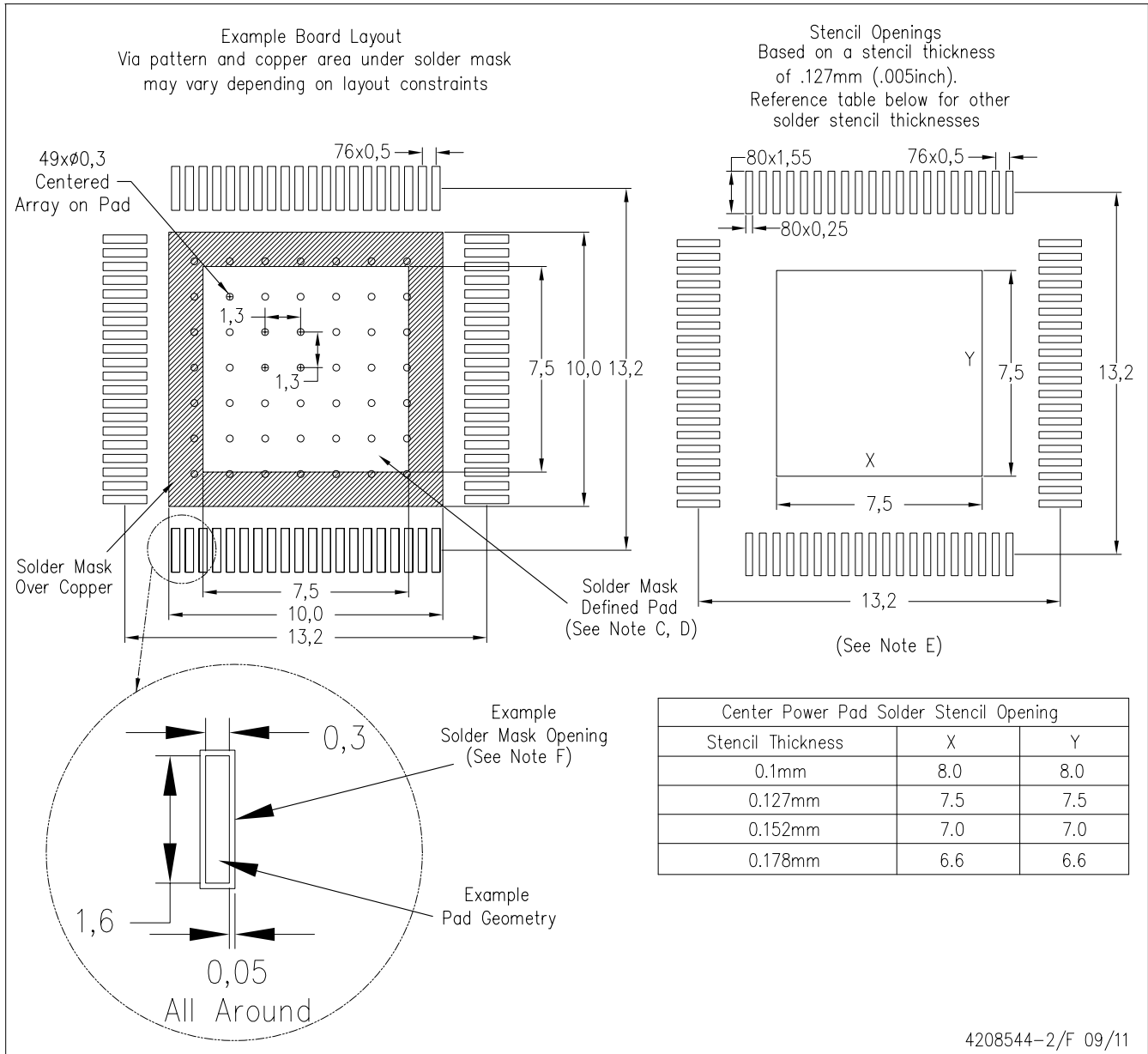

- NOTES:
- All linear dimensions are in millimeters.
 - This drawing is subject to change without notice.
 - Customers should place a note on the circuit board fabrication drawing not to alter the center solder mask defined pad.
 - This package is designed to be soldered to a thermal pad on the board. Refer to Technical Brief, PowerPad Thermally Enhanced Package, Texas Instruments Literature No. SLMA002, SLMA004, and also the Product Data Sheets for specific thermal information, via requirements, and recommended board layout. These documents are available at www.ti.com <<http://www.ti.com>>. Publication IPC-7351 is recommended for alternate designs.
 - Laser cutting apertures with trapezoidal walls and also rounding corners will offer better paste release. Customers should contact their board assembly site for stencil design recommendations. Example stencil design based on a 50% volumetric metal load solder paste. Refer to IPC-7525 for other stencil recommendations.
 - Customers should contact their board fabrication site for solder mask tolerances between and around signal pads.

PowerPAD is a trademark of Texas Instruments.

IMPORTANT NOTICE

Texas Instruments Incorporated and its subsidiaries (TI) reserve the right to make corrections, modifications, enhancements, improvements, and other changes to its products and services at any time and to discontinue any product or service without notice. Customers should obtain the latest relevant information before placing orders and should verify that such information is current and complete. All products are sold subject to TI's terms and conditions of sale supplied at the time of order acknowledgment.

TI warrants performance of its hardware products to the specifications applicable at the time of sale in accordance with TI's standard warranty. Testing and other quality control techniques are used to the extent TI deems necessary to support this warranty. Except where mandated by government requirements, testing of all parameters of each product is not necessarily performed.

TI assumes no liability for applications assistance or customer product design. Customers are responsible for their products and applications using TI components. To minimize the risks associated with customer products and applications, customers should provide adequate design and operating safeguards.

TI does not warrant or represent that any license, either express or implied, is granted under any TI patent right, copyright, mask work right, or other TI intellectual property right relating to any combination, machine, or process in which TI products or services are used. Information published by TI regarding third-party products or services does not constitute a license from TI to use such products or services or a warranty or endorsement thereof. Use of such information may require a license from a third party under the patents or other intellectual property of the third party, or a license from TI under the patents or other intellectual property of TI.

Reproduction of TI information in TI data books or data sheets is permissible only if reproduction is without alteration and is accompanied by all associated warranties, conditions, limitations, and notices. Reproduction of this information with alteration is an unfair and deceptive business practice. TI is not responsible or liable for such altered documentation. Information of third parties may be subject to additional restrictions.

Resale of TI products or services with statements different from or beyond the parameters stated by TI for that product or service voids all express and any implied warranties for the associated TI product or service and is an unfair and deceptive business practice. TI is not responsible or liable for any such statements.

TI products are not authorized for use in safety-critical applications (such as life support) where a failure of the TI product would reasonably be expected to cause severe personal injury or death, unless officers of the parties have executed an agreement specifically governing such use. Buyers represent that they have all necessary expertise in the safety and regulatory ramifications of their applications, and acknowledge and agree that they are solely responsible for all legal, regulatory and safety-related requirements concerning their products and any use of TI products in such safety-critical applications, notwithstanding any applications-related information or support that may be provided by TI. Further, Buyers must fully indemnify TI and its representatives against any damages arising out of the use of TI products in such safety-critical applications.

TI products are neither designed nor intended for use in military/aerospace applications or environments unless the TI products are specifically designated by TI as military-grade or "enhanced plastic." Only products designated by TI as military-grade meet military specifications. Buyers acknowledge and agree that any such use of TI products which TI has not designated as military-grade is solely at the Buyer's risk, and that they are solely responsible for compliance with all legal and regulatory requirements in connection with such use.

TI products are neither designed nor intended for use in automotive applications or environments unless the specific TI products are designated by TI as compliant with ISO/TS 16949 requirements. Buyers acknowledge and agree that, if they use any non-designated products in automotive applications, TI will not be responsible for any failure to meet such requirements.

Following are URLs where you can obtain information on other Texas Instruments products and application solutions:

Products

Audio	www.ti.com/audio
Amplifiers	amplifier.ti.com
Data Converters	dataconverter.ti.com
DLP® Products	www.dlp.com
DSP	dsp.ti.com
Clocks and Timers	www.ti.com/clocks
Interface	interface.ti.com
Logic	logic.ti.com
Power Mgmt	power.ti.com
Microcontrollers	microcontroller.ti.com
RFID	www.ti-rfid.com
OMAP Mobile Processors	www.ti.com/omap
Wireless Connectivity	www.ti.com/wirelessconnectivity

Applications

Automotive and Transportation	www.ti.com/automotive
Communications and Telecom	www.ti.com/communications
Computers and Peripherals	www.ti.com/computers
Consumer Electronics	www.ti.com/consumer-apps
Energy and Lighting	www.ti.com/energy
Industrial	www.ti.com/industrial
Medical	www.ti.com/medical
Security	www.ti.com/security
Space, Avionics and Defense	www.ti.com/space-avionics-defense
Video and Imaging	www.ti.com/video

TI E2E Community Home Page

e2e.ti.com

Mailing Address: Texas Instruments, Post Office Box 655303, Dallas, Texas 75265
Copyright © 2012, Texas Instruments Incorporated